

RCA

Solid State

TRANSISTORS · TRANSISTORS · TRANSISTORS · TRANSISTORS · TRANSISTORS · TRANSISTORS

RF DEVICES · RF DEVICES · RF DEVICES · RF DEVICES · RF DEVICES · RF DEVICES

RECTIFIERS · THYRISTORS / RECTIFIERS · THYRISTORS / RECTIFIERS · THYRISTORS / RECTIFIERS

HIGH-REL TYPES · HIGH-REL TYPES · HIGH-REL TYPES · HIGH-REL TYPES · HIGH-REL TYPES

RCA Power Devices

This DATABOOK contains complete technical information on the full line of RCA solid-state power devices: power transistors, rf power transistors, power hybrid circuits, triacs, SCR's, diacs, silicon rectifiers, and rectifier assemblies. A complete index of these types is included on the following pages.

The index to devices is followed by a series of product selection charts that provide a quick reference to key parameters and device packages to facilitate type selection. A cross-reference guide then indicates recommended RCA replacements for more than 2000 popular industry types. Next, general operating considerations for solid-state power devices are discussed, and symbols and special terms used to characterize these devices are listed.

The DATABOOK also contains eight data sections that provide detailed ratings and characteristics for each of the various types of devices. Data pages for individual devices are given as nearly as possible in alpha-numerical sequence of the basic family type numbers. Because many devices may be included in the same basic family, individual type numbers are not necessarily in sequence. *If you don't find a type number where you expect it to be, check the Index to Devices.*

General information such as test circuits and waveforms, dimensional outlines, suggested mounting arrangements, and lead forms for plastic packages are included in an Appendix at the back of the book. The Appendix also includes abstracts of relevant RCA application notes. The final pages contain listings of RCA sales offices, manufacturers' representatives, and authorized distributors.

Table of Contents

	Page
Index to Devices	3
Power-Transistor Selection Charts	8
Audio Transistors	17
Power Hybrid Comparison Chart	18
RF Power Transistors Selection Charts	19
Triac Product Matrix	20
SCR Product Matrix	23
ITR Product Matrix	24
GTO Product Matrix	25
Diac Product Matrix	25
Rectifier Product Matrix	25
Power-Devices Cross-Reference Guide	26
Operating Considerations	46
Terms and Symbols	50
Power Transistors – Technical Data	53
RF Power Transistors – Technical Data	417
Power Hybrid Circuits – Technical Data	451
Triacs – Technical Data	457
Silicon Controlled Rectifiers – Technical Data	513
Gate-Turn-off SCR's (GTO's) – Technical Data	569
Diacs – Technical Data	572
Rectifiers – Technical Data	575
RCA High-Reliability Solid-State Power Devices	579
Appendix:	
General Characteristics, Test Circuits, and Waveforms	586
Dimensional Outlines	595
Suggested Hardware and Mounting Arrangements	603
Lead Forms for RCA Plastic Power Packages	606
Handling and Mounting of RCA Molded-Plastic	
Transistors and Thyristors	609
Application-Note Abstracts	613
RCA Sales Offices, Manufacturers' Representatives, and	
Authorized Distributors	617

RCA Solid State

Brussels · Buenos Aires · Hamburg · Madrid · Mexico City · Milan
Montreal · Paris · Sao Paulo · Somerville NJ · Stockholm
Sunbury-on-Thames · Taipei · Tehran · Tokyo

Information furnished by RCA is believed to be accurate and reliable. However, no responsibility is assumed by RCA for its use; nor for any infringements of patents or other rights of third parties which may result from its use. No license is granted by implication or otherwise under any patent or patent rights of RCA.

Copyright 1978 by RCA Corporation
(All rights reserved under Pan-American
Copyright Convention)

Trademark(s) ® Registered
Marca(s) Registrada(s)

Printed in USA/7-78

Index to Devices

Type No.	Page	Type of Device	Bulletin File No.	Type No.	Page	Type of Device	Bulletin File No.	Type No.	Page	Type of Device	Bulletin File No.
1N248C	576	R	6	2N1479*	60	PT	135	2N3651	564	SCR	408
1N249C	576	R	6	2N1480*	60	PT	135	2N3652	564	SCR	408
1N250C	576	R	6	2N1481*	60	PT	135	2N3653	564	SCR	408
1N1183A	576	R	38	2N1482*	60	PT	135	2N3654	564	SCR	724
1N1184A	576	R	38	2N1483*	65	PT	137	2N3655	564	SCR	724
1N1186A	576	R	38	2N1484*	65	PT	137	2N3656	564	SCR	724
1N1187A	576	R	38	2N1485*	65	PT	137	2N3657	564	SCR	724
1N1188A	576	R	38	2N1486*	65	PT	137	2N3658	564	SCR	724
1N1189A	576	R	38	2N1487*	67	PT	139	2N3668	541	SCR	116
1N1190A	576	R	38	2N1488*	67	PT	139	2N3669	541	SCR	116
1N1195A	576	R	6	2N1489*	67	PT	139	2N3670	541	SCR	116
1N1196A	576	R	6	2N1490*	67	PT	139	2N3715	99	PT	1058
1N1197A	576	R	6	2N1613	54	PT	106	2N3716	99	PT	1058
1N1198A	576	R	6	2N1700	60	PT	141	2N3733	425	RF	72
1N1199A	576	R	20	2N1701	65	PT	141	2N3771*	101	PT	974
1N1200A	576	R	20	2N1702	67	PT	141	2N3772*	101	PT	974
1N1202A	576	R	20	2N1711	54	PT	26	2N3773	105	PT	526
1N1203A	576	R	20	2N1842A	556	SCR	28	2N3791	109	PT	1059
1N1204A	576	R	20	2N1843A	556	SCR	28	2N3792	109	PT	1059
1N1205A	576	R	20	2N1844A	556	SCR	28	2N3839	426	RF	229
1N1206A	576	R	20	2N1845A	556	SCR	28	2N3866*	427	RF	80
1N1341B	576	R	58	2N1846A	556	SCR	28	2N3870	553	SCR	578
1N1342B	576	R	58	2N1847A	556	SCR	28	2N3871	553	SCR	578
1N1344B	576	R	58	2N1848A	556	SCR	28	2N3872	553	SCR	578
1N1345B	576	R	58	2N1849A	556	SCR	28	2N3873	553	SCR	578
1N1346B	576	R	58	2N1850A	556	SCR	28	2N3878	111	PT	766
1N1347B	576	R	58	2N1893	54	PT	34	2N3879	111	PT	766
1N1348B	576	R	58	2N2102	54	PT	106	2N3896	553	SCR	578
1N3879	577	R	726	2N2270	54	PT	24	2N3897	553	SCR	578
1N3880	577	R	726	2N2405	54	PT	34	2N3898	553	SCR	578
1N3881	577	R	726	2N2857*	418	RF	61	2N3899	553	SCR	578
1N3882	577	R	726	2N2876	419	RF	32	2N4012	428	RF	90
1N3883	577	R	726	2N3053	54	PT	960	2N4036	115	PT	216
1N3889	577	R	727	2N2053A	54	PT	960	2N4037	115	PT	216
1N3890	577	R	727	2N3054	69	PT	527	2N4063	84	PT	64
1N3891	577	R	727	2N3055	73	PT	994	2N4064	84	PT	64
1N3892	577	R	727	2N3055	77	PT	1077	2N4101	523	SCR	114
1N3893	577	R	727	(Hometaxial)				2N4102	523	SCR	114
1N3899	578	R	728	2N3228	523	SCR	114	2N4103	541	SCR	116
1N3900	578	R	728	2N3229*	420	RF	50	2N4231A	118	PT	1102
1N3901	578	R	728	2N3263	82	PT	54	2N4232A	118	PT	1102
1N3902	578	R	728	2N3264	82	PT	54	2N4233A	118	PT	1102
1N3903	578	R	728	2N3265	82	PT	54	2N4240	96	PT	138
1N3909	578	R	729	2N3266	82	PT	54	2N4314	115	PT	216
1N3910	578	R	729	2N3375*	421	RF	386	2N4347	91	PT	528
1N3911	578	R	729	2N3439*	84	PT	64	2N4348	105	PT	526
1N3912	578	R	729	2N3440*	84	PT	64	2N4427	429	RF	228
1N3913	578	R	729	2N3441*	87	PT	529	2N4440*	430	RF	217
2N681	556	SCR	96	2N3442*	91	PT	528	2N4904	121	PT	1068
2N682*	556	SCR	96	2N3478	423	RF	77	2N4905	121	PT	1068
2N683*	556	SCR	96	2N3525	523	SCR	114	2N4906	121	PT	1068
2N684*	556	SCR	96	2N3528	523	SCR	114	2N4913	123	PT	1067
2N685*	556	SCR	96	2N3529	523	SCR	114	2N4914	123	PT	1067
2N686	556	SCR	96	2N3553*	421	RF	386	2N4915	123	PT	1067
2N687*	556	SCR	96	2N3583	96	PT	138	2N4932	431	RF	249
2N688*	556	SCR	96	2N3584*	96	PT	138	2N4933	431	RF	249
2N689*	556	SCR	96	2N3585*	96	PT	138	2N5038*	125	PT	698
2N690*	556	SCR	96	2N3600	424	RF	83	2N5039*	125	PT	698
2N697	54	PT	16	2N3632	421	RF	386	2N5050	130	PT	1098
2N699	54	PT	22	2N3650	564	SCR	408	2N5051	130	PT	1098

Index to Devices

Type No.	Page	Type of Device	Bulletin File No.	Type No.	Page	Type of Device	Bulletin File No.	Type No.	Page	Type of Device	Bulletin File No.
2N5052	130	PT	1098	2N5782	158	PT	413	2N6251	204	PT	523
2N5070	432	RF	268	2N5783	158	PT	413	2N6253	77	PT	1077
2N5071*	433	RF	269	2N5784	158	PT	413	2N6254	77	PT	1077
2N5090	434	RF	270	2N5785	158	PT	413	2N6257	101	PT	974
2N5102	435	RF	279	2N5786	158	PT	413	2N6259	105	PT	526
2N5109*	436	RF	281	2N5806	503	TRI	913	2N6260	69	PT	527
2N5179	437	RF	288	2N5807	503	TRI	913	2N6261	69	PT	527
2N5180	439	RF	289	2N5808	503	TRI	913	2N6262	91	PT	528
2N5202	111	PT	766	2N5809	503	TRI	913	2N6263	87	PT	529
2N5239	132	PT	321	2N5838*	162	PT	410	2N6264	87	PT	529
2N5240	132	PT	321	2N5839*	162	PT	410	2N6282	207	PT	1001
2N5293	135	PT	322	2N5840*	162	PT	410	2N6283	207	PT	1001
2N5294	135	PT	322	2N5869	165	PT	1070	2N6284	207	PT	1001
2N5295	135	PT	322	2N5870	165	PT	1070	2N6285	207	PT	1001
2N5296	135	PT	322	2N5871	167	PT	1066	2N6286	207	PT	1001
2N5297	135	PT	322	2N5872	167	PT	1066	2N6287	207	PT	1001
2N5298	135	PT	322	2N5873	167	PT	1066	2N6288	190	PT	676
2N5301	139	PT	1029	2N5874	167	PT	1066	2N6289	190	PT	676
2N5302	139	PT	1029	2N5875	169	PT	1065	2N6290	190	PT	676
2N5303	139	PT	1029	2N5876	169	PT	1065	2N6291	190	PT	676
2N5320	142	PT	325	2N5877	169	PT	1065	2N6292	190	PT	676
2N5321	142	PT	325	2N5878	169	PT	1065	2N6293	190	PT	676
2N5322	142	PT	325	2N5879	171	PT	1064	2N6300	210	PT	1095
2N5323	142	PT	325	2N5880	171	PT	1065	2N6301	210	PT	1095
2N5415*	145	PT	336	2N5881	171	PT	1065	2N6306	212	PT	885
2N5416*	145	PT	336	2N5882	171	PT	1065	2N6307	212	PT	885
2N5441	503	TRI	593	2N5885	173	PT	1041	2N6308	212	PT	885
2N5442	503	TRI	593	2N5886	173	PT	1041	2N6312	118	PT	1102
2N5443	503	TRI	593	2N5913	440	RF	423	2N6313	118	PT	1102
2N5444	503	TRI	593	2N5954	175	PT	675	2N6314	118	PT	1102
2N5445	503	TRI	593	2N5955	175	PT	675	2N6326	215	PT	1040
2N5446	503	TRI	593	2N5956	175	PT	675	2N6327	215	PT	1040
2N5490	148	PT	353	2N6032	180	PT	462	2N6342A	493	TRI	1084
2N5491	148	PT	353	2N6033	180	PT	462	2N6343A	493	TRI	1084
2N5492	148	PT	353	2N6055	217	PT	563	2N6344A	493	TRI	1084
2N5493	148	PT	353	2N6056	217	PT	563	2N6345A	493	TRI	1084
2N5494	148	PT	353	2N6077	183	PT	492	2N6346A	493	TRI	1084
2N5495	148	PT	353	2N6078	183	PT	492	2N6347A	493	TRI	1084
2N5496	148	PT	353	2N6079	183	PT	492	2N6348A	493	TRI	1084
2N5497	148	PT	353	2N6098	187	PT	485	2N6349A	493	TRI	1084
2N5567	480	TRI	457	2N6099	187	PT	485	2N6354	125	PT	582
2N5568	480	TRI	457	2N6100	187	PT	485	2N6371	77	PT	1077
2N5569	480	TRI	457	2N6101	187	PT	485	2N6372	175	PT	675
2N5570	480	TRI	457	2N6102	187	PT	485	2N6373	175	PT	675
2N5571	480	TRI	458	2N6103	187	PT	485	2N6374	175	PT	675
2N5572	480	TRI	458	2N6106	190	PT	676	2N6383	217	PT	609
2N5573	480	TRI	458	2N6107	190	PT	676	2N6384	217	PT	609
2N5574	480	TRI	458	2N6108	190	PT	676	2N6385	217	PT	609
2N5575	151	PT	359	2N6109	190	PT	676	2N6386	221	PT	610
2N5578	151	PT	359	2N6110	190	PT	676	2N6387	221	PT	610
2N5632	154	PT	1094	2N6111	190	PT	676	2N6388	221	PT	610
2N5633	154	PT	1094	2N6211*	197	PT	507	2N6394	546	SCR	891
2N5634	154	PT	1094	2N6212*	197	PT	507	2N6395	546	SCR	891
2N5671*	156	PT	383	2N6213*	197	PT	507	2N6396	546	SCR	891
2N5672*	156	PT	383	2N6214	197	PT	507	2N6397	546	SCR	891
2N5754	461	TRI	414	2N6246	200	PT	677	2N6398	546	SCR	891
2N5755	461	TRI	414	2N6247	200	PT	677	2N6400	546	SCR	892
2N5756	461	TRI	414	2N6248	200	PT	677	2N6401	546	SCR	892
2N5757	461	TRI	414	2N6249	204	PT	523	2N6402	546	SCR	892
2N5781	158	PT	413	2N6250	204	PT	523	2N6403	546	SCR	892

Index to Devices

Type of Bulletin				Type of Bulletin				Type of Bulletin			
Type No.	Page	Device	File No.	Type No.	Page	Device	File No.	Type No.	Page	Device	File No.
2N6404	546	SCR	892	2N6676	267	PT	1087	40631	276	PT	965
2N6420	224	PT	1100	2N6677	267	PT	1087	40634			Same as RCA1A05
2N6421	224	PT	1100	2N6678	267	PT	1087	40635			Same as RCA1A06
2N6422	224	PT	1100	40250, V1	69	PT	112	40636			Same as RCA1B01
2N6465	175	PT	888	40251	77	PT	112	40814			Same as RCA1A07
2N6466	175	PT	888	40280	443	RF	68	40815			Same as RCA1A08
2N6467	175	PT	888	40290	444	RF	70	40829	175	PT	675
2N6468	175	PT	888	40291	444	RF	70	40830	175	PT	675
2N6469	200	PT	677	40292	444	RF	70	40831	175	PT	675
2N6470	200	PT	677	40310	270	PT	962	40850	278	PT	964
2N6471	200	PT	677	40311	270	PT	962	40851	278	PT	964
2N6472	200	PT	677	40312	270	PT	962	40852	278	PT	964
2N6473	190	PT	676	40313	270	PT	962	40854	278	PT	964
2N6474	190	PT	676	40314	270	PT	962	40871	281	PT	699
2N6475	190	PT	676	40316	270	PT	962	40872	281	PT	699
2N6476	190	PT	676	40317	270	PT	962	40894	447	RF	548
2N6477	227	PT	680	40318	270	PT	962	40895	447	RF	548
2N6478	227	PT	680	40319	270	PT	962	40896	447	RF	548
2N6479	230	PT	702	40321	270	PT	962	40897	447	RF	548
2N6480	230	PT	702	40322	270	PT	962	40910	69	PT	527
2N6486	233	PT	678	40323	270	PT	962	40911	69	PT	527
2N6487	233	PT	678	40324	270	PT	962	40912	87	PT	529
2N6488	233	PT	678	40325	270	PT	962	40913	87	PT	529
2N6489	233	PT	678	40327	270	PT	962	40936	448	RF	551
2N6490	233	PT	678	40340	445	RF	74	40964	449	RF	581
2N6491	233	PT	678	40341	445	RF	74	40965	449	RF	581
2N6496	125	PT	698	40346, V1, V2	84	PT	211	40979			Same as RCA1C10
2N6500	111	PT	766	40347, V1, V2	60	PT	88	40980			Same as RCA1C11
2N6510	235	PT	848	40348, V1, V2	60	PT	88	41024	450	RF	658
2N6511	235	PT	848	40349, V1, V2	60	PT	88	41500	190	PT	772
2N6512	235	PT	848	40360			Same as RCA1A01	41501	190	PT	770
2N6513	235	PT	848	40362	270	PT	962	41502	54	PT	773
2N6514	235	PT	848	40363	270	PT	962	41503	115	PT	774
2N6530	238	PT	873	40366	54	PT	215	41504	276	PT	965
2N6531	238	PT	873	40367	60	PT	215	BD142	283	PT	701
2N6532	238	PT	873	40368	65	PT	215	BD181	285	PT	700
2N6533	238	PT	873	40369	67	PT	215	BD182	285	PT	700
2N6534	242	PT	874	40372	69	PT	527	BD183	285	PT	700
2N6535	242	PT	874	40373	87	PT	529	BD239, A, B, C	288	PT	669
2N6536	242	PT	874	40374	96	PT	138	BD240, A, B, C	288	PT	670
2N6537	242	PT	874	40375	111	PT	766	BD241, A, B, C	290	PT	671
2N6542	246	PT	1096	40385	84	PT	215	BD242, A, B, C	290	PT	672
2N6544	246	PT	1096	40389	54	PT	960	BD243, A, B, C	292	PT	673
2N6546	246	PT	1096	40390	84	PT	64	BD244, A, B, C	292	PT	674
2N6569	73	PT	994	40391	115	PT	216	BD277	294	PT	667
2N6594	73	PT	994	40392	54	PT	960	BD278, A	295	PT	969
2N6609	250	PT	1061	40394	115	PT	216	BD450	297	PT	1107
2N6648	253	PT	1013	40406	274	PT	219	BD451	297	PT	1107
2N6649	253	PT	1013	40407	274	PT	219	BD500, A, B	299	PT	1108
2N6650	253	PT	1013	40408	274	PT	219	BD501, A, B	299	PT	1108
2N6666	255	PT	1069	40409	274	PT	219	BD550, A, B	301	PT	1109
2N6667	255	PT	1069	40410	274	PT	219	BDX18	73	PT	994
2N6668	255	PT	1069	40411	274	PT	219	BDX33, A, B, C	307	PT	693
2N6669	258	PT	1071	40412, V1, V2	84	PT	211	BDX34, A, B, C	307	PT	694
2N6670	441	PT	1091	40537	270	PT	320	BDX83, A, B, C	310	PT	955
2N6671	260	PT	1090	40538	270	PT	320	BDY29	313	PT	819
2N6672	260	PT	1090	40539	270	PT	303	BDY37	315	PT	863
2N6673	260	PT	1090	40594			Same as RCA1A03	BDY71	317	PT	859
2N6674	264	PT	1085	40595			Same as RCA1A04	BFT19, A, B	319	PT	683
2N6675	264	PT	1085	40608	446	RF	356	BFT28, A, B	321	PT	815

Index to Devices

Type No.	Page	Type of Device	Bulletin File No.	Type No.	Page	Type of Device	Bulletin File No.	Type No.	Page	Type of Device	Bulletin File No.
BU106	323	PT	716	RCA1A10	346	PT	651	RCP117,B	383	PT	822
BU126	325	PT	968	RCA1A11	346	PT	651	RCP131A,B,C,D	386	PT	904
BU133	325	PT	968	RCA1A15	346	PT	651	RCP133A,B,C,D	386	PT	904
BU207	326	PT	1088	RCA1A16	346	PT	651	RCP135,B	386	PT	904
BU208,A	326	PT	1088	RCA1A17	346	PT	651	RCP137,B	386	PT	904
BUX16,A,B,C	329	PT	800	RCA1A18	346	PT	651	RCP700A,B,C,D	388	PT	821
BUX17,A,B,C	332	PT	818	RCA1A19	346	PT	651	RCP701A,B,C,D	388	PT	820
BUX18,A,B,C	335	PT	862	RCA1B01	350	PT	647	RCP702A,B,C,D	388	PT	821
BUX66,A,B,C	337	PT	870	RCA1B04	351	PT	908	RCP703A,B,C,D	388	PT	820
BUX67,A,B,C	337	PT	871	RCA1B05	351	PT	908	RCP704,B	388	PT	821
C106A,B,C,D,E, F,M,Q,Y	514	SCR	1005	RCA1B06	357	PT	648	RCP705,B	388	PT	820
C107A,B,C,D,E, F,M,Q,Y	514	SCR	1005	RCA1B09	351	PT	908	RCP706,B	388	PT	821
C108A,B,C,D,E, F,M,Q,Y	514	SCR	1005	RCA1C03	358	PT	652	RCP707,B	388	PT	820
CH2102	413	PT	632	RCA1C04	358	PT	652	RCS29,A,B,C	394	PT	880
CH2270	413	PT	632	RCA1C05	359	PT	644	RCS30,A,B,C	396	PT	881
CH2405	413	PT	632	RCA1C06	359	PT	644	RCS31,A,B,C	398	PT	882
CH3053	413	PT	632	RCA1C07	361	PT	646	RCS32,A,B,C	400	PT	883
CH3439	413	PT	632	RCA1C08	361	PT	646	RCS258	101	PT	974
CH3440	413	PT	632	RCA1C09	363	PT	645	RCS579	212	PT	886
CH4036	413	PT	632	RCA1C10	364	PT	642	RCS617	73	PT	994
CH4037	413	PT	632	RCA1C11	364	PT	642	RCS618	73	PT	994
CH5320	413	PT	632	RCA1C12	358	PT	652	RCS683,A,B	392	PT	974
CH5321	413	PT	632	RCA1C13	358	PT	652	RCS880	145	PT	777
CH5322	413	PT	632	RCA1C14	366	PT	643	RCS881	145	PT	780
CH5323	413	PT	632	RCA1C15	367	PT	1010	RCS882	145	PT	781
CH6479	413	PT	632	RCA1C16	367	PT	1010	S106A,B,C,D,E, F,M,Q,Y	517	SCR	966
D2101S	535	R	522	RCA1E02	369	PT	653	S107A,B,C,D,E, F,M,Q,Y	517	SCR	966
D2103SF	535	R	522	RCA1E03	369	PT	653	S122A,B,C,D,E, F,M,S	529	SCR	889
D2406A,B,C,D, F,M	577	R	663	RCA29,A,B,C	394	PT	583	S2060A,B,C,D E,F,M,Q,Y	520	SCR	654
D2412A,B,C,D, F,M	577	R	664	RCA30,A,B,C	396	PT	584	S2061A,B,C,D E,F,M,Q,Y	520	SCR	654
D2520A,B,C,D, F,M	578	R	665	RCA31,A,B,C	398	PT	585	S2062A,B,C,D, E,F,M,Q,Y	520	SCR	654
D2540A,B,D,F,M	578	R	580	RCA32,A,B,C	400	PT	586	S2600B,D,M	526	SCR	496
D2600M	535	R	839	RCA41,A,B,C	402	PT	587	S2610B,D,M	526	SCR	496
D2601E,M	535	R	723	RCA42,A,B,C	404	PT	588	S2620B,D,M	526	SCR	496
D3202U,Y	574	D	577	RCA120	408	PT	840	S2710B,D,M	523	SCR	266
G4000A,B,D	570	SCR	1052	RCA121	408	PT	840	S2800A,B,C,D, E,F,M,S	529	SCR	890
G4001A,B,D	570	SCR	1052	RCA122	408	PT	840	S3700B,D,M	532	SCR	306
HC2000H	452	PH	566	RCA125	411	PT	841	S3701M	533	SCR	476
HC2500	452	PH	681	RCA126	411	PT	841	S3702S	535	SCR	522
MAC15,A	496	TRI	1086	RCA410	370	PT	509	S3703SF	535	SCR	522
MJ2955	73	PT	994	RCA411	372	PT	510	S3704A,B,D,M,S	532	SCR	690
MJ15001	341	PT	1093	RCA413	374	PT	511	S3705M	535	SCR	839
MJ15002	341	PT	1093	RCA423	376	PT	512	S3706E	535	SCR	839
MJ15003	343	PT	1060	RCA431	378	PT	513	S3714A,B,D,M,S	532	SCR	690
MJ15004	250	PT	1060	RCA1000	217	PT	594	S3900MF,S,SF	538	ITR	938
RCA1A01	346	PT	651	RCA1001	217	PT	594	S3901M,MF,S	538	ITR	938
RCA1A02	346	PT	651	RCA3054	135	PT	618	S3902DF	538	ITR	938
RCA1A03	346	PT	651	RCA3055	187	PT	618	S3903MF	538	ITR	938
RCA1A04	346	PT	651	RCA3441	227	PT	666	S5800B,C,D,E,M	544	SCR	1051
RCA1A05	346	PT	651	RCA3733	743	PT	1060	S5801B,C,D,E,M	544	SCR	1051
RCA1A06	346	PT	651	RCA6263	227	PT	666	S5802B,C,D,E,M	544	SCR	1051
RCA1A07	346	PT	651	RCA8203A,B	255	PT	835	S6000C,E,S	546	SCR	891
RCA1A08	346	PT	651	RCA8350A,B	253	PT	861	S6100C,E,S	546	SCR	892
RCA1A09	346	PT	651	RCA8638C,D,E	343	PT	1060				
				RCA8766A,B,C, D	380	PT	973				
				RCA9116C,D,E	250	PT	1061				
				RCP111A,B,C,D	383	PT	822				
				RCP113A,B,C,D	383	PT	822				
				RCP115,B	383	PT	822				

Index to Devices

Type No.	Page	Type of Device	Bulletin File No.	Type No.	Page	Type of Device	Bulletin File No.	Type No.	Page	Type of Device	Bulletin File No.
S6200A,B,D,M	549	SCR	418	T2327A,B,C,D,E,F	466	TRI	1042	T6001B,C,D,E,F,M	490	TRI	1004
S6210A,B,D,M	549	SCR	418	T2500B,D	469	TRI	615	T6006B,C,D,E,M	490	TRI	1004
S6220A,B,D,M	549	SCR	418	T2506B,D	512	TRI	406	M			
S6230A,B,D,M	552	SCR	877	T2700B,D	471	TRI	351	T6401B,D,E,F,M	503	TRI	459
S6240A,B,D,M	552	SCR	877	T2706B,D	512	TRI	406	T6404B,D,E	507	TRI	487
S6250A,B,D,M	552	SCR	877	T2710B,D	471	TRI	351	T6405B,D,E	507	TRI	487
S6400N	553	SCR	578	T2716B,D	512	TRI	406	T6406B,D,E,M	512	TRI	406
S6410N	553	SCR	578	T2800A,B,C,D,E,F,M	473	TRI	838	T6407B,D,E,M	512	TRI	406
S6420A,B,D,M,N	553	SCR	578	T2801A,B,C,D,E,F,M	473	TRI	837	T6411B,D,E,F,M	503	TRI	459
S6430A,B,D,M,N	552	SCR	877	T2802B,C,D,E,M	473	TRI	838	T6414B,D	507	TRI	487
S6440A,B,D,M,N	552	SCR	877	T2806B,D	512	TRI	406	T6415B,D	507	TRI	487
S6450A,B,D,M,N	552	SCR	877	T2850A,B,D,E,F	473	TRI	540	T6416B,D,M	512	TRI	406
S6493M	559	SCR	247	T2851B,C,D,E	477	TRI	1083	T6417B,D,M	512	TRI	406
S7310B,C,D,E,M	561	SCR	975	T2856B,D	512	TRI	406	T6420B,D,E,F,M	503	TRI	593
S7410M	564	SCR	408	T4100E,F,M	480	TRI	458	T6421B,D,E,F,M	503	TRI	459
S7412M	564	SCR	724	T4101E,F,M	480	TRI	457	T6422B,D,M	512	TRI	406
S8610A,B,D,M	566	SCR	1020	T4103B,D,E,M	484	TRI	443	T6430B,D,E,F,M	486	TRI	878
S8611A,B,D,M	566	SCR	1020	T4104B,D,E,M	484	TRI	443	T6431B,D,E,F,M	486	TRI	878
S8612A,B,D,M	566	SCR	1020	T4105B,D,M	484	TRI	443	T6440B,D,E,F,M	486	TRI	878
S8613A,B,D,M	566	SCR	1020	T4106B,D,M	512	TRI	406	T6441B,D,E,F,M	486	TRI	878
S8620A,B,D,M	566	SCR	1020	T4107B,D,M	512	TRI	406	T6450B,D,E,F,M	486	TRI	878
S8621A,B,D,M	566	SCR	1020	T4110E,F,M	480	TRI	458	T6451B,D,E,F,M	486	TRI	878
S8622A,B,D,M	566	SCR	1020	T4111E,F,M	480	TRI	457	T8411B,D,E,F,M	509	TRI	725
S8623A,B,D,M	566	SCR	1020	T4113B,D,E,M	484	TRI	443	T8421B,D,E,F,M	509	TRI	725
SC149B,D,E,M	498	TRI	1082	T4114B,D,E,M	484	TRI	443	TIC236B,D	501	TRI	1078
SC151B,D,E,M	498	TRI	1082	T4115B,D,E,M	484	TRI	443	TIC246B,D	501	TRI	1078
T2300A,B,D,F	458	TRI	911	T4116B,D,M	512	TRI	406	TIP29,A,B,C	394	PT	990
T2301A,B,D,F	458	TRI	911	T4117B,D,M	512	TRI	406	TIP30,A,B,C	396	PT	988
T2302A,B,D,F	458	TRI	911	T4120B,D,E,F,M	480	TRI	458	TIP31,A,B,C	398	PT	991
T2303F	461	TRI	912	T4121B,D,E,F,M	480	TRI	457	TIP32,A,B,C	400	PT	987
T2304B,D	464	TRI	441	T4126B,D,M	512	TRI	406	TIP41,A,B,C	402	PT	992
T2305B,D	464	TRI	441	T4127B,D,M	512	TRI	406	TIP42,A,B,C	404	PT	996
T2306A,B,D	512	TRI	406	T4130B,D,E,F,M	486	TRI	878	TIP47	406	PT	978
T2310A,B,D,F	458	TRI	911	T4131B,D,E,F,M	486	TRI	878	TIP48	406	PT	978
T2311A,B,D,F	458	TRI	911	T4131B,D,E,F,M	486	TRI	878	TIP49	406	PT	978
T2312A,B,D,F	458	TRI	911	T4140B,D,E,F,M	486	TRI	878	TIP50	406	PT	978
T2313A,B,D,F,M	461	TRI	912	T4141B,D,E,F,M	486	TRI	878	TIP120	408	PT	998
T2316A,B,D	512	TRI	406	T4150B,D,E,F,M	486	TRI	878	TIP121	408	PT	998
T2320A,B,C,D,E,F	466	TRI	1042	T4151B,D,E,F,M	486	TRI	878	TIP122	408	PT	998
T2322A,B,C,D,E,F	466	TRI	1042	T4700B,D,E,F	488	TRI	300	TIP125	411	PT	997
T2323A,B,C,D,E,F	466	TRI	1042	T6000B,C,D,E,F,M	490	TRI	1004	TIP126	411	PT	997
								TIP127	411	PT	997

BR = Bridge rectifier
D = Diac
GTO = Gate-turn-off SCR
ITR = Integrated thyristor/rectifier

PH = Power hybrid circuit
PT = Power transistor
R = Rectifier
RA = Rectifier assembly

RF = RF power transistor
SCR = Silicon controlled rectifier
TRI = Triac
* JAN-type versions also available.

Power Transistor Selection Charts

N-P-N SILICON POWER TRANSISTORS

Type No.	V _{CEO(sus)} V	Current Gain			P _T (Max.) W	I _C (Max.) A	f _T MHz	Sw. Times ^A		Package	p-n-p Complement
		h _{FE}	I _C A	V _{CE} V				t _{ON} μs	t _f		
I_C(Max.) = 0.15 to 1 A, f_T = 3 to 25 MHz											
40346	175	25 min.	0.010	10	10	1	15	—	—	TO-39	—
41505 [†]	200	20 min.	0.050	10	20	1	21	—	—	Plastic TO-5	—
2N3440	250	40-160	0.020	10	10	1	15	—	—	TO-39	2N5415
40412	250*	40 min.	0.030	20	10	1	15	—	—	TO-39	—
TIP47	250	10 min.	1	10	40	1	5	0.2	0.5	TO-220AB	—
40321	300*	25-200	0.020	10	5	1	15	—	—	TO-39	—
TIP48	300	10 min.	1	10	40	1	5	0.2	0.5	TO-220AB	—
2N3439	350	40-160	0.020	10	10	1	15	—	—	TO-39	2N5416
TIP49	350	10 min.	1	10	40	1	5	0.2	0.5	TO-220AB	—
TIP50	400	10 min.	1	10	40	1	5	0.2	0.5	TO-220AB	—
I_C(Max.) = 0.15 to 1 A, f_T = 50 to 100 MHz											
41502	30	20 min.	0.150	10	3	1	60	—	—	TO-39	41503
2N3053	40	50-250	0.150	10	5	1	60	—	—	TO-39	2N4037
2N3053A	60	50-250	0.150	10	5	0.7	60	—	—	TO-39	—
2N2102	65	25 min.	0.500	10	5	1	60	30 ns [⊕]	—	TO-39	2N4036
RCP115	100	50 min.	0.025	10	6.25	0.150	80	—	—	TO-202AB	—
RCP117	100	20 min.	0.025	10	6.25	0.150	80	—	—	TO-202AB	—
RCP111A	200	50-300	0.025	10	6.25	0.150	80	—	—	TO-202AB	—
RCP113A	200	30-150	0.025	10	6.25	0.150	80	—	—	TO-202AB	—
RCP111B	250	50-300	0.025	10	6.25	0.150	80	—	—	TO-202AB	—
RCP113B	250	30-150	0.025	10	6.25	0.150	80	—	—	TO-202AB	—
RCP115B	250	50 min.	0.025	10	6.25	0.150	80	—	—	TO-202AB	—
RCP117B	250	20 min.	0.025	10	6.25	0.150	80	—	—	TO-202AB	—
RCP111C	300	50-300	0.025	10	6.25	0.150	80	—	—	TO-202AB	—
RCP113C	300	30-150	0.025	10	6.25	0.150	80	—	—	TO-202AB	—
RCP111D	350	50-300	0.025	10	6.25	0.150	80	—	—	TO-202AB	—
RCP113D	350	30-150	0.025	10	6.25	0.150	80	—	—	TO-202AB	—
I_C(Max.) = 1.5 to 2 A, f_T = 0.2 to 1.5 MHz											
2N1479	40	20-60	0.200	4	5	1.5	1.4	1.2	1	TO-39	—
2N1481	40	35-100	0.200	4	5	1.5	1.4	1.2	1	TO-39	—
40347	40	20-150	0.450	4	8.75	1.5	1.5	—	—	TO-39	—
2N1480	55	20-60	0.200	4	5	1.5	1.4	1.2	1	TO-39	—
2N1482	55	35-100	0.200	4	5	1.5	1.4	1.2	1	TO-39	—
40348	65	10 min.	1	4	8.75	1.5	1.5	—	—	TO-39	—
40349	140	10 min.	0.450	4	8.75	1.5	0.9	—	—	TO-39	—
I_C(Max.) = 1.5 to 2 A, f_T = 3 to 25 MHz											
2N5050	125	5	2	5	40	2	25	0.3@	1.2	TO-213MA	—
BUX67	150	10-150	1	5	35	2	10	3	3	TO-66	BUX66
2N5051	150	5	2	5	40	2	10	0.3@	1.2	TO-213MA	—
2N5052	200	5	2	5	40	2	10	0.3@	1.2	TO-213MA	—
2N3584	250	8-80	1	2	35	2	10	3	3	TO-66	2N6211
BUX67A	250	10-150	1	5	35	2	10	3	3	TO-66	BUX66A
2N3585	300	8-80	1	2	35	2	10	3	3	TO-66	2N6212
2N4240	300	10-100	0.750	2	35	2	15	0.5	3	TO-66	—
BUX67B	300	10-150	1	5	35	2	10	3	3	TO-66	BUX66B
BUX67C	350	10-150	1	5	35	2	10	3	3	TO-66	BUX66C
I_C(Max.) = 1.5 to 2A, f_T = 50 to 100 MHz											
RCP705	30	50 min.	0.500	4	10	2	50	80 ns	800 ns*	TO-202AB	RCP704
RCP707	30	20 min.	0.500	4	10	2	50	80 ns	800 ns*	TO-202AB	RCP706
RCP701A	40	50-250	0.500	4	10	2	50	80 ns	800 ns*	TO-202AB	RCP700A
RCP703A	40	30-150	0.500	4	10	2	50	80 ns	800 ns*	TO-202AB	RCP702A
2N5321	50	40-250	0.500	4	10	2	50	80 ns	800 ns*	TO-39	2N5323
2N6179	50	40-250	0.500	4	25	2	50	80 ns	800 ns*	Plastic TO-5	2N6181
2N6670	50	30	0.4	2	10	1.5	50	—	—	TO-202AB	—
RCP701B	60	50-250	0.500	4	10	2	50	80 ns	800 ns*	TO-202AB	RCP700B
RCP703B	60	30-150	0.500	4	10	2	50	80 ns	800 ns*	TO-202AB	RCP702B
RCP705B	60	50 min.	0.500	4	10	2	50	80 ns	800 ns*	TO-202AB	RCP704B
RCP707B	60	20 min.	0.500	4	10	2	50	80 ns	800 ns*	TO-202AB	RCP706B
2N5320	75	30-130	0.500	4	10	2	50	80 ns	800 ns*	TO-39	2N5322
2N6178	75	30-130	0.500	4	25	2	50	80 ns	800 ns*	Plastic TO-5	2N6180
RCP701C	80	50-250	0.500	4	10	2	50	80 ns	800 ns*	TO-202AB	RCP700C
RCP703C	80	30-150	0.500	4	10	2	50	80 ns	800 ns*	TO-202AB	RCP702C
RCA1A03	95*	70-300	0.300	4	10	2	50	—	—	TO-39	RCA1A04
RCP701D	100	50-250	0.500	4	10	2	50	80 ns	800 ns*	TO-202AB	RCP700D
RCP703D	100	30-150	0.500	4	10	2	50	80 ns	800 ns*	TO-202AB	RCP702D

^A Measured at same current level as h_{FE} unless otherwise indicated

* V_{CER(sus)}

* t_{OFF}

[†] Check availability in Europe, the Middle East, and Africa.

[⊕] t_d + t_r + t_f

@ t_r

Power Transistor Selection Charts

N-P-N SILICON POWER TRANSISTORS (cont'd)

Type No.	V _{CEO} (sus) V	Current Gain			PT (Max.) W	I _C (Max.) A	f _T MHz	Sw. Times [▲]		Package	p-n-p Complement
		h _{FE}	I _C A	V _{CE} V				t _{ON} μs	t _f		
I_C (Max.) = 2.5 to 5A, f_T = 0.2 to 2 MHz											
2N1483	40	20-60	0.750	4	25	3	0.8	1.2	1.1	TO-8	—
2N1485	40	35-100	0.750	4	25	3	0.8	1.2	1.1	TO-8	—
2N5786	40	20-100	1.6	2	10	3.5	1	5 [○]	15* [○]	TO-39	2N5783
2N5295	40	30-120	1	4	36	4	0.8	5	15*	TO-220AB	2N6108
2N5296	40	30-120	1	4	36	4	0.8	5	15*	TO-220AB	2N6109
2N6260	40	3 min	4	2	29	3	0.8	—	—	TO-66	—
40250	40	25 min.	1.5	4	29	4	1	—	—	TO-66	2N5956
2N5785	50	20-100	1.2	2	10	3.5	1	5 [○]	15* [○]	TO-39	2N5782
2N1484	55	20-80	0.750	4	25	3	0.8	1.2	1.1	TO-8	—
2N1486	55	35-100	0.750	4	25	3	0.8	1.2	1.1	TO-8	—
2N3054	55	5 min.	3	4	25	4	0.8	—	—	TO-66	2N5955
RCA3054	55	5 min.	3	4	36	4	0.8	—	—	TO-220AB	—
BDY71	55	5 min.	3	4	29	4	0.8	—	—	TO-66	—
2N5297	60	20-80	1.5	4	36	4	0.8	5	15*	TO-220AA	2N6106
2N5298	60	20-80	1.5	4	36	4	0.8	5	15*	TO-220AB	2N6107
2N5784	65	20-100	1	2	10	3.5	1	5	15*	TO-39	2N5781
2N5293	70	30-120	0.5	4	36	4	0.8	5	15*	TO-220AA	2N6106
2N5294	70	30-120	0.5	4	36	4	0.8	5	15*	TO-220AB	2N6107
2N6261	80	5 min.	4	2	50	4	0.8	—	—	TO-66	—
RCA8638E	100	10	7.5	2	200	20	2	—	—	TO-204MA	RCA9116E
RCA8638D	120	10	10	2	200	20	2	—	—	TO-204MA	RCA9116D
2N6477	120	5 min.	2.5	4	50	2.5	0.2	—	—	TO-220AB	—
2N6263	120	3 min.	3	2	20	3	0.2	—	—	TO-66	2N6468
RCA6263	120	20-150	0.5	4	36	3	0.2	—	—	TO-220AB	—
2N4347	120	10 min.	5	4	100	5	0.2	—	—	TO-3	2N6248
2N6478	140	5 min.	2.5	4	50	2.5	0.2	—	—	TO-220AB	—
2N3441	140	5 min.	2.7	4	25	3	0.2	—	—	TO-66	2N6468
RCA3441	140	20-150	0.5	4	36	3	0.2	—	—	TO-220AB	—
RCA3773	140	5	16	4	150	20	2	—	—	TO-204MA	2N6609
RCA8638C	140	10	10	2	200	20	2	—	—	TO-204MA	RCA9116C
MJ15003	140	10	10	2	250	20	2	—	—	TO-204MA	MJ15004
2N6264	150	5 min.	3	2	50	3	0.2	—	—	TO-66	—
BU207	600	2.25	4.5	5	12.5	5	1	—	0.6	TO-204MA	—
BU208	700	2.25	4.5	5	12.5	5	1	—	0.6	TO-204MA	—
BU208A	700	2.5	4.5	5	12.5	5	1	—	0.6	TO-204MA	—
I_C = 2.5 to 5 A, f_T = 3 to 25 MHz											
RCA29 [◆]	40	15-150	1	4	30	3	3	0.4	1.2*	TO-220AB	RCA30
RCA31 [◆]	40	25 min.	1	4	40	5	3	0.4	1.2*	TO-220AB	RCA32
RCS29 [◆]	40	15-150	1	4	30	3	3	0.4	1.2*	TO-66	RCS30
RCS31 [◆]	40	25 min.	1	4	40	5	3	0.4	1.2*	TO-66	RCS32
TIP29	40	15-150	1	4	30	3	3	0.4	1.2*	TO-220AB	TIP30
TIP31	40	25 min.	1	4	40	5	3	0.4	1.2*	TO-220AB	TIP32
BD239	45	15 min.	1	4	30	4	3	—	—	TO-220AB	BD240
BD241	45	25 min.	1	4	40	5	3	—	—	TO-220AB	BD242
BD239A	60	15 min.	1	4	30	4	3	—	—	TO-220AB	BD240A
BD241A	60	25 min.	1	4	40	5	3	—	—	TO-220AB	BD242A
RCA29A [◆]	60	15-150	1	4	30	3	3	0.4	1.2*	TO-220AB	RCA30A
RCA31A [◆]	60	25 min.	1	4	40	5	3	0.4	1.2*	TO-220AB	RCA32A
TIP29A	60	15-150	1	4	30	3	3	0.4	1.2*	TO-220AB	TIP30A
TIP31A	60	25 min.	1	4	40	5	3	0.4	1.2*	TO-220AB	TIP32A
BD239B	80	15 min.	1	4	30	4	3	—	—	TO-220AB	BD240B
BD241B	80	25 min.	1	4	40	5	3	—	—	TO-220AB	BD242B
RCA29B [◆]	80	15-150	1	4	30	3	3	0.4	1.2*	TO-220AB	RCA30B
RCA31B [◆]	80	25 min.	1	4	40	5	3	0.4	1.2*	TO-220AB	RCA32B
TIP29B	80	15-150	1	4	30	3	3	0.4	1.2*	TO-220AB	TIP30B
TIP31B	80	25 min.	1	4	40	5	3	0.4	1.2*	TO-220AB	TIP32B
2N6465	100	5 min.	4	4	40	4	5	—	—	TO-66	2N6467
2N6473	100	2 min.	4	2.5	40	4	4	—	—	TO-220AB	2N6475
2N5869	60	4	5	4	87.5	5	4	0.7 [@]	0.8	TO-204MA	—
2N5870	80	4	5	4	87.5	5	4	0.7 [@]	0.8	TO-204MA	—
BD239C	100	15 min.	1	4	30	4	3	—	—	TO-220AB	BD240C
BD241C	100	25 min.	1	4	40	5	3	—	—	TO-220AB	BD242C
RCA29C [◆]	100	15-150	1	4	30	3	3	0.4	1.2*	TO-220AB	RCA30C
RCA31C [◆]	100	25 min.	1	4	40	5	3	0.4	1.2*	TO-220AB	RCA32C
TIP29C	100	15-150	1	4	30	3	3	0.4	1.2*	TO-220AB	TIP30C
TIP31C	100	25 min.	1	4	40	5	3	0.4	1.2*	TO-220AB	TIP32C

▲Measured at same current level as h_{FE} unless otherwise indicated

*V_{CER} (sus)

*t_{OFF}

◆Check availability in Europe, the Middle East, and Africa.

@t_r

○At I_C = 1A

Power Transistor Selection Charts

N-P-N SILICON POWER TRANSISTORS (cont'd)

Type No.	V _{CEO} (sus) V	Current Gain			P _T (Max.) W	I _C (Max.) A	f _T MHz	Sw. Times [▲]		Package	p-n-p Complement
		h _{FE}	I _C A	V _{CE} V				t _{ON} μs	t _f		
I_C = 2.5 to 5 A, f_T = 3 to 25 MHz (cont'd)											
2N6466	120	5 min.	4	4	40	4	5	—	—	TO-66	2N6468
2N6474	120	2 min.	4	2.5	40	4	4	—	—	TO-220AB	2N6476
BUX16	200	5 min.	4.5	10	100	5	5	—	—	TO-3	—
2N5239	225	5 min.	4.5	10	100	5	5	—	—	TO-3	—
2N5838	250	8-40	3	2	100	3	5	0.86	0.4	TO-3	—
BU133	250	15-80	1	5	80	3	3.5	—	0.5	TO-3	—
BUX16A	250	5 min.	4.5	10	100	5	5	—	—	TO-3	—
2N5839	275	10-50	2	3	100	3	5	0.67	0.35	TO-3	—
2N5240	300	5 min.	4.5	10	100	5	5	—	—	TO-3	—
2N6542	300	7	3	2	100	5	6	0.75	0.8	TO-204MA	—
BU126	300	15-60	1	5	80	3	3.5	—	0.5	TO-3	—
BUX16B	300	5 min.	4.5	10	100	5	5	—	—	TO-3	—
2N5840	350	10-50	2	3	100	3	5	0.67	0.35	TO-3	—
BUX16C	350	5 min.	4.5	10	100	5	5	—	—	TO-3	—
I_C = 2.5 to 5 A, f_T = 50 to 100 MHz											
2N3878	50	20 min.	4	5	35	4	40	—	—	TO-66	—
2N5202	50	10-100	4	1.2	35	4	60	0.44	0.4	TO-66	—
2N6500	90	15-60	3	2	35	4	60	0.44	0.5	TO-66	—
I_C = 6 to 10 A, f_T = 0.2 to 1 MHz											
2N1487	40	15-45	1.5	4	75	6	0.8	—	—	TO-3	—
2N1489	40	25-75	1.5	4	75	6	0.8	—	—	TO-3	—
2N5490	40	20-100	2	4	50	7	0.8	5	15*	TO-220AB	2N6109
2N5491	40	20-100	2	4	50	7	0.8	5	15*	TO-220AA	2N6108
2N5494	40	20-100	3	4	50	7	0.8	5	15*	TO-220AB	2N6109
2N5495	40	20-100	3	4	50	7	0.8	5	15*	TO-220AA	2N6108
BD278	45	15-75	4	4	75	10	0.8	—	—	TO-220AB	—
2N1488	55	15-45	1.5	4	75	6	0.8	—	—	TO-3	—
2N1490	55	25-75	1.5	4	75	6	0.8	—	—	TO-3	—
2N5492	55	20-100	2.5	4	50	7	0.8	5	15*	TO-220AB	2N6107
2N5493	55	20-100	2.5	4	50	7	0.8	5	15*	TO-220AA	2N6106
2N3715	60	5	10	4	150	10	25	—	—	TO-204MA	—
2N3716	80	5	10	4	150	10	25	—	—	TO-204MA	—
2N6098	60	5 min.	10	4	75	10	0.8	—	—	TO-220AA	—
2N6099	60	5 min.	10	4	75	10	0.8	—	—	TO-220AB	—
BD278A	60	15-75	4	4	75	10	0.8	—	—	TO-220AB	—
2N5496	70	20-100	3.5	4	50	7	0.8	5	15*	TO-220AB	2N6107
2N5497	70	20-100	3.5	4	50	7	0.8	5	15*	TO-220AA	2N6106
2N6100	70	20-80	5	4	75	10	0.8	—	—	TO-220AA	—
2N6101	70	20-80	5	4	75	10	0.8	—	—	TO-220AB	—
2N5632	100	5	10	2	150	10	1	—	—	TO-204MA	—
2N4348	120	10 min.	10	4	120	10	0.2	—	—	TO-3	2N6248
2N5633	120	5	10	2	150	10	1	—	—	TO-204MA	—
2N5634	140	5	10	2	150	10	1	—	—	TO-204MA	—
2N3442	140	7.5 min.	10	4	117	10	0.8	—	—	TO-3	—
2N6262	150	5 min.	10	2	150	10	0.8	—	—	TO-3	—
2N6078	250	12-70	1.2	1	45	7	1	0.32	0.3	TO-66	—
2N6077	275	12-70	1.2	1	45	7	1	0.32	0.3	TO-66	—
2N6079	350	12-50	1.2	1	45	7	1	0.32	0.3	TO-66	—
I_C = 6 to 10 A, f_T = 2.5 to 25 MHz											
41500	25	25 min.	1	4	40	7	4	—	—	TO-220AB	41501
2N6288	30	2.3 min.	7	4	40	7	4	—	—	TO-220AB	2N6111
2N6289	30	2.3 min.	7	4	40	7	4	—	—	TO-220AA	2N6110
2N6374	40	5 min.	6	4	40	6	4	—	—	TO-66	2N5956
RCA41 [◆]	40	15-150	3	4	65	7	3	0.6 [●]	1.4 ^{**}	TO-220AB	RCA42
TIP41	40	15-150	3	4	65	7	3	0.6 [●]	1.4 ^{**}	TO-220AB	TIP42
BD243	45	15 min.	3	4	65	7	2	—	—	TO-220AB	BD244
2N6290	50	2.3 min.	7	4	40	7	4	—	—	TO-220AB	2N6109
2N5871	60	4	10	4	150	10	20	—	—	TO204MA	—
2N5878	80	4	10	4	150	10	20	—	—	TO-204MA	—
2N6671	300	10	5	3	150	8	15	0.8 [@]	0.8	TO-204MA	—
2N6672	350	10	5	3	150	8	15	0.8 [@]	0.8	TO-204MA	—
2N6673	400	10	5	3	150	8	15	0.8 [@]	0.8	TO-204MA	—
2N6669	30	20	5	2	40	10	10	0.35	0.5	TO-220AB	—
BD243	45	15 min.	3	4	65	7	2	—	—	TO-220AB	BD244
2N6290	50	2.3 min.	7	4	40	7	4	—	—	TO-220AB	2N6109
2N6291	50	2.3 min.	7	4	40	7	4	—	—	TO-222AA	2N6108

[▲]Measured at same current level as h_{FE} unless otherwise indicated

[◆]Check availability in Europe, the Middle East, and Africa.

^{*}t_{OFF}
[@]t_r

[●]At I_C = 6A

Power Transistor Selection Charts

N-P-N SILICON POWER TRANSISTORS (cont'd)

Type No.	V _{CEO(sus)} V	Current Gain			P _T (Max.) W	I _C (Max.) A	f _T MHz	Sw. Times [▲]		Package	p-n-p Complement
		h _{FE}	I _C A	V _{CE} V				t _{ON} μs	t _f		
I_C = 6 to 10 A, f_T = 2.5 to 25 MHz (cont'd)											
2N6373	60	5 min.	6	4	40	6	4	—	—	TO-66	2N5955
BD243A	60	15 min.	3	4	65	7	3	—	—	TO-220AB	BD244A
RCA41A [▲]	60	15-150	3	4	65	7	3	0.6 [●]	1.4 ^{**}	TO-220AB	RCA42A
TIP41A	60	15-150	3	4	65	7	3	0.6 [●]	1.4 ^{**}	TO-220AB	—
2N6292	70	2.3 min.	7	4	40	7	4	—	—	TO-220AB	2N6107
2N6293	70	2.3 min.	7	4	40	7	4	—	—	TO-220AA	2N6106
2N6372	80	5 min.	6	4	40	6	4	—	—	TO-66	2N5954
BD243B	80	15 min.	3	4	65	7	3	—	—	TO-220AB	BD244B
RCA41B	80	15-150	3	4	65	7	3	0.6 [●]	1.4 ^{**}	TO-220AB	RCA42B
TIP41B	80	15-150	3	4	65	7	3	0.6 [●]	1.4 ^{**}	TO-220AB	—
BD243C	100	15 min.	3	4	65	7	3	—	—	TO-220AB	BD244C
RCA41C	100	15-150	3	4	65	7	3	0.6 [●]	1.4 ^{**}	TO-220AB	RCA42C
TIP41C	100	15-150	3	4	65	7	3	0.6 [●]	1.4 ^{**}	TO-220AB	—
BU106	140	8 min.	4	5	75	7	3	—	1.5	TO-3	—
BUX17	150	7 min.	10	3	150	10	2.5	2	1	TO-3	—
2N6249	200	10-50	10	3	175	10	8	0.8 [@]	0.5	TO-3	—
2N6510	200	10-50	3	3	120	7	3	0.8	0.5	TO-3	—
BUX18	200	7 min.	6	3	120	8	3	—	0.6 [▲]	TO-3	—
RCA410	200	30 min.	1	5	125	7	4	0.35 [@]	0.15	TO-3	—
2N6306	250	15-75	3	5	125	8	5	0.6 [@]	0.4	TO-3	—
2N6511	250	10-50	4	3	120	7	3	0.8	0.5	TO-3	—
BUX17A	250	7 min.	10	3	150	10	2.5	2	1	TO-3	—
RCS579 [◆]	250	12 min.	3	5	125	8	5	0.6 [@]	0.4	TO-3	—
2N6250	275	8-50	10	3	175	10	8	0.8 [@]	0.5	TO-3	—
BUX18A	275	7 min.	5	3	120	8	3	—	0.6 [▲]	TO-3	—
2N6307	300	15-75	3	5	125	8	5	0.6 [@]	0.4	TO-3	—
2N6512	300	10-50	4	3	120	7	3	1.7	1.5	TO-3	—
2N6514	300	10-50	5	3	120	7	3	0.8	0.5	TO-3	—
2N6544	300	7	5	2	125	8	6	1.05	1	TO-204MA	—
BUX17B	300	7 min.	8	3	150	10	2.5	2	1	TO-3	—
RCA411	300	30-90	1	5	125	7	2.5	0.35 [@]	0.15	TO-3	—
RCA8767	300	8 min.	6	3	175	10	20	0.4 [@]	0.3	TO-3	—
BUX18B	325	10 min.	4	3	120	8	3	—	0.6 [▲]	TO-3	—
RCA413	325	15 min.	1	5	125	7	4	0.35 [@]	0.15	TO-3	—
RCA423	325	30-90	1	5	125	7	4	0.35 [@]	0.15	TO-3	—
RCA431	325	15-35	2.5	5	125	7	4	0.35 [@]	0.15	TO-3	—
2N6251	350	6-50	10	3	175	10	8	0.8 [@]	0.5	TO-3	—
2N6308	350	12-60	3	5	125	8	5	0.6 [@]	0.4	TO-3	—
2N6513	350	10-50	4	3	120	7	3	0.8	0.5	TO-3	—
BUX17C	350	7 min.	8	3	150	10	2.5	2	1	TO-3	—
BUX18C	375	10 min.	4	3	120	8	3	—	0.6 [▲]	TO-3	—
RCA8766	350	100 min.	6	3	150	10	10	—	—	TO-3	—
RCA8766A	350	100 min.	4	3	150	10	10	—	—	TO-3	—
RCA8767A	350	8 min.	6	3	175	10	20	0.4 [@]	0.3	TO-3	—
BUX18C	375	10 min.	4	3	120	8	3	—	0.6 [▲]	TO-3	—
RCA8766B	400	100 min.	6	3	150	10	10	—	—	TO-3	—
RCA8766C	400	100 min.	4	3	150	10	10	—	—	TO-3	—
RCA8767B	400	8 min.	6	3	175	10	20	0.4 [@]	0.3	TO-3	—
RCA8766D	450	100 min.	6	3	150	10	10	—	—	TO-3	—
RCA8766E	450	100 min.	4	3	150	10	10	—	—	TO-3	—
I_C = 6 to 10 A, f_T = 50 to 100 MHz											
2N3879	75	12-100	4	2	35	7	60	0.44	0.4	TO-66	—
2N6354	120	2 min.	10	2	140	10	80	1 [@]	0.2	TO-3	—
I_C = 12 to 20 A, f_T = 0.2 to 2 MHz											
2N6102	40	5 min.	16	4	75	16	0.8	—	—	TO-220AA	—
2N6103	40	5 min.	16	4	75	16	0.8	—	—	TO-220AB	—
2N6257	40	5 min.	20	4	150	20	0.2	—	—	TO-3	—
2N6371	40	4 min.	16	4	117	16	0.8	—	—	TO-3	2N6469
2N6569	40	5-100	12	4	100	12	1.5	1.9 [■]	1.5 [■]	TO-3	2N6594
RCA41/SDH [◆]	40	15 min.	3	4	75	16	0.8	3.23 [@]	3.7 ^{**}	TO-220AB	—
2N6253	45	3 min.	15	4	115	15	0.8	—	—	TO-3	—
BD142	45	12.5-160	4	4	117	15	0.8	—	—	TO-3	—
BD181	45	20-70	3	4	117	15	0.8	—	—	TO-3	—
2N3055 (Hom.)	60	5 min.	10	4	115	15	0.8	—	—	TO-3	2N6246
2N3772	60	5 min.	20	4	150	20	0.2	—	—	TO-3	2N6246
BD182	60	20-70	4	4	117	15	0.8	—	—	TO-3	—
RCA3055	60	5 min.	10	4	75	15	0.8	—	—	TO-220AB	—

▲ Measured at same current level as h_{FE} unless otherwise indicated

● At I_C = 6A

▲ At I_C = 4A

@_{t_r}

*t_{OFF}

◆ Check availability in Europe, the Middle East, and Africa.

■ At I_C = 2A

Power Transistor Selection Charts

N-P-N SILICON POWER TRANSISTORS (cont'd)

Type No.	V _{CEO(sus)} V	Current Gain			P _T (Max.) W	I _C (Max.) A	f _T MHz	Sw. Times ^a		Package	p-n-p Complement
		h _{FE}	I _C A	V _{CE} V				t _{ON} μs	t _f		
I_C = 12 to 20 A, f_T = 0.2 to 2 MHz (cont'd)											
2N5881	60	4	15	4	160	15	4	—	—	TO-204MA	2N5879
RCS258 [♦]	60	5 min.	20	4	250	20	0.2	—	—	TO-3	—
40363	70*	20-70	4	4	115	15	0.7	—	—	TO-3	—
2N6254	80	5 min.	15	4	150	15	0.8	—	—	TO-3	—
RCS617	80	20	5	4	115	15	2.5	—	—	TO-204MA	RCS618
2N5882	80	4	15	4	160	15	4	—	—	TO-204MA	2N5880
BD183	80	20-70	3	4	117	15	0.8	—	—	TO-3	—
RCA1B01 [♦]	95*	20-70	4	4	115	15	0.8	—	—	TO-3	—
2N3773	120	5 min.	16	4	150	16	0.2	—	—	TO-3	—
BDY37	140	15-60	8	4	150	16	0.2	—	—	TO-3	—
MJ15001	140	25	4	2	200	15	2	—	—	TO-204MA	MJ15002
2N6259	150	10 min.	16	4	250	16	0.2	—	—	TO-3	—
I_C = 12 to 20 A, f_T = 2.5 to 25 MHz											
2N6470	40	5 min.	15	4	125	15	5	—	—	TO-3	2N6469
2N6486	40	5 min.	15	4	75	15	5	—	—	TO-220AB	2N6489
2N3055	60	20-70	4	4	115	15	2.5	1.9 [■]	1.5 [■]	TO-3	MJ2955
2N6471	60	5 min.	15	4	125	15	5	—	—	TO-3	2N6246
2N6487	60	5 min.	15	4	75	15	5	—	—	TO-220AB	2N6490
2N6472	80	5 min.	15	4	125	15	5	—	—	TO-3	2N6247
2N6488	80	5 min.	15	4	75	15	5	—	—	TO-220AB	2N6491
RCS617	80	20-70	5	4	115	15	2.5	1.9 [■]	1.5 [■]	TO-3	RCS618
2N6674	300	8	10	2	175	15	15	0.7	0.5	TO-204MA	—
2N6676	300	8	15	3	175	15	15	—	—	TO-204MA	—
RCA9113	300	15 min.	5	3	175	15	20	1.03*	0.75 ^x	TO-3/ TO-204MA	—
RCA9113A	350	15 min.	5	3	175	15	20	1.03*	0.76 ^x	TO-3/ TO-204MA	—
2N6677	350	8	15	3	175	15	15	—	—	TO-204MA	—
2N6675	400	8	10	2	175	15	15	0.7	0.5	TO-204MA	—
2N6678	400	8	15	3	175	15	15	—	—	TO-204MA	—
RCA9113B	400	15 min.	3	3	175	15	20	1.03*	0.75 ^x	TO-3/ TO-204MA	—
I_C = 12 to 20 A, f_T = 50 to 100 MHz											
2N6479 [■]	60	20-300	12	2	87	12	100	—	—	Radial [■]	—
2N6481 [■]	60	20-300	12	2	117	12	100	—	—	Radial	—
2N5039	75	20-100	10	5	140	20	60	0.5 [@]	0.5	TO-3	—
2N6480 [■]	80	20-300	12	2	87	12	100	—	—	Radial [■]	—
2N6482 [■]	80	20-300	12	2	117	12	100	—	—	Radial	—
2N5038	90	20-100	12	5	140	20	60	0.5 [@]	0.5	TO-3	—
2N6496	110	12-100	8	2	140	15	60	0.5 [@]	0.5	TO-3	—
I_C = 25 to 50 A, f_T = 0.2 to 1 MHz											
2N3771	40	5 min.	30	4	150	30	0.2	—	—	TO-3	—
2N5301	40	5	30	3	200	30	2	2 [@]	1	TO-204MA	—
2N5302	60	5	30	3	200	30	2	2 [@]	1	TO-204MA	—
BDY29	75	15-60	15	2	220	30	0.2	—	—	TO-3	—
2N5303	80	5	20	3	200	30	2	2 [@]	1	TO-204MA	—
I_C = 25 to 50 A, f_T = 2.5 to 25 MHz											
2N3264	60	20-80	15	3	125	25	20	0.5	0.5	Radial	—
2N3266	60	20-80	15	3	125	25	20	0.5	0.5	TO-63	—
2N5885	60	4	25	4	200	25	4	0.7 [@]	0.8	TO-204MA	—
2N6326	60	6	30	4	200	30	3	0.45	0.9*	TO-204MA	—
2N5886	80	4	25	4	200	25	4	0.7 [@]	0.8	TO-204MA	—
2N6327	80	6	30	4	200	30	3	0.45	0.9*	TO-204MA	—
2N3263	90	25-75	15	3	125	25	20	0.5	0.5	Radial	—
2N3265	90	25-75	15	3	125	25	20	0.5	0.5	TO-63	—
2N6546	300	6	10	2	175	15	6	1.05	0.7	TO-204MA	—
I_C = 25 to 50 A, f_T = 50 to 100 MHz											
2N6032	90	10-50	50	2.6	140	50	50	1 [@]	0.5	Mod. TO-3	—
2N5671	90	20-100	15	2	140	30	50	0.5	0.5	TO-3	—
2N6033	120	10-50	40	2	140	40	50	1 [@]	0.5	Mod. TO-3	—
2N5672	120	20-100	15	2	140	30	50	0.5	0.5	TO-3	—
I_C ≥ 60 A, f_T = 0.4 MHz											
2N5575	50	10-40	60	4	300	80	0.4	15	15	Mod. TO-3	—
2N5578	70	10-40	40	3	300	60	0.4	15	15	Mod. TO-3	—

^aMeasured at same current level as h_{FE} unless otherwise indicated

[♦]At I_C = 6A

[♦]At I_C = 4A

^{*}t_{OFF}

[@]t_r

[■]Check availability in Europe, the Middle East, and Africa.

[■]At I_C = 2A

[■]V_{CE(sus)}

^xAt I_C = 10 A

[%]Radiation hardened

Power Transistor Selection Charts

P-N-P SILICON POWER TRANSISTORS

Type No.	V _{CEO(sus)} V	Current Gain			P _T (Max.) W	I _C (Max.) A	f _T MHz	Sw. Times [*]		Package	n-p-n Complement
		h _{FE}	I _C A	V _{CE} V				t _{ON} μs	t _f		
I_C = -0.15 to -1 A, f_T = 0.2 to 1 MHz											
BFT28	-100	20 min.	-0.010	-10	5	-1	25	-	-	TO-39	-
BFT19	-150	20 min.	-0.050	-10	5	-1	25	-	-	TO-39	-
BFT28A	-150	20 min.	-0.010	-10	5	-1	25	-	-	TO-39	-
RCS880 [♦]	-150	20-150	-0.050	-10	7.5	-1	15	-	-	TO-39	-
2N5415	-200	30-150	-0.050	-10	10	-1	15	-	-	TO-39	2N3440
BFT28B	-200	20 min.	-0.010	-10	5	-1	25	-	-	TO-39	-
BFT19A	-250	20 min.	-0.050	-10	5	-1	25	-	-	TO-39	-
BFT28C	-250	20 min.	-0.010	-10	5	-1	25	-	-	TO-39	-
RC881 [♦]	-250	20 min.	-0.035	-10	7.5	-1	15	-	-	TO-39	-
2N5416	-300	30-120	-0.050	-10	10	-1	15	-	-	TO-39	2N3439
RCS882 [♦]	-300	20 min.	-0.035	-10	7.5	-1	15	-	-	TO-39	-
BFT19B	-350	20 min.	-0.050	-10	5	-1	25	-	-	TO-39	-
I_C = -0.15 to -1 A, f_T = 50 to 100 MHz											
41503	-30	20 min.	-0.150	-10	7	-1	60	-	-	TO-39	41502
2N4037	-40	50-250	-0.150	-10	7	-1	60	-	-	TO-39	2N3053
2N4036	-65	40-140	-0.150	-10	7	-1	60	0.11	0.1	TO-39	2N2102
2N4314	-65	50-250	-0.150	-10	7	-1	60	-	-	TO-39	-
I_C = -1.5 to -2 A, f_T = 2.5 to 25 MHz											
BUX66	-150	10-150	-1	-5	35	-2	20	0.6 [Ⓞ]	0.6	TO-66	BUX67
2N6211	-225	10-100	-1	-2.8	20	-2	20	0.6 [Ⓞ]	0.6	TO-66	2N3584
BUX66A	-250	10-150	-1	-5	35	-2	20	0.6 [Ⓞ]	0.6	TO-66	BUX67A
2N6212	-300	10-100	-1	-3.2	20	-2	20	0.6 [Ⓞ]	0.6	TO-66	2N3585
BUX66B	-300	10-150	-1	-5	35	-2	20	0.6 [Ⓞ]	0.6	TO-66	BUX67B
2N6213	-350	10-100	-1	-4	20	-2	20	0.6 [Ⓞ]	0.6	TO-66	2N3585
BUX66C	-350	10-150	-1	-5	35	-2	20	0.6 [Ⓞ]	0.6	TO-66	BUX67C
2N6214	-400	10-100	-1	-5	20	-2	20	0.6 [Ⓞ]	0.6	TO-66	-
I_C = -1.5 to -2 A, f_T = 50 to 100 MHz											
RCP704	-30	50 min.	-0.5	-4	10	-2	50	0.1	1*	TO-202AB	RCP705
RCP706	-30	20 min.	-0.5	-4	10	-2	50	0.1	1*	TO-202AB	RCP707
RCP700A	-40	50-250	-0.5	-4	10	-2	50	0.1	1*	TO-202AB	RCP701A
RCP702A	-40	30-150	-0.5	-4	10	-2	50	0.1	1*	TO-202AB	RCP703A
2N5322	-50	40-250	-0.5	-4	10	-2	50	0.1	1*	TO-39	2N5321
2N6181	-50	40-250	-0.5	-4	25	-2	50	0.1	1*	Plastic TO-5	2N6179
RCP700B	-60	50-250	-0.5	-4	10	-2	50	0.1	1*	TO-202AB	RCP701B
RCP702B	-60	30-150	-0.5	-4	10	-2	50	0.1	1*	TO-202AB	RCP703B
RCP704B	-60	50 min.	-0.5	-4	10	-2	50	0.1	1*	TO-202AB	RCP705B
RCP706B	-60	20 min.	-0.5	-4	10	-2	50	0.1	1*	TO-202AB	RCP707B
2N5322	-75	30-130	-0.5	-4	10	-2	50	0.1	1*	TO-39	2N5320
2N6180	-75	30-150	-0.5	-4	25	-2	50	0.1	1*	Plastic TO-5	2N6178
RCP700C	-80	50-250	-0.5	-4	10	-2	50	0.1	1*	TO-202AB	RCP701C
RCP702C	-80	30-150	-0.5	-4	10	-2	50	0.1	1*	TO-202AB	RCP703C
RCA1A04 [♦]	-95*	50 min.	-0.1	-4	10	-2	50	-	-	TO-39	RCA1A03
RCP700D	-100	50-250	-0.5	-4	10	-2	50	0.1	1*	TO-202AB	RCP701D
RCP702D	-100	30-150	-0.5	-4	10	-2	50	0.1	1*	TO-202AB	RCP703D
I_C = -2.5 to -5 A, f_T = 2.5 to 25 MHz											
2N4915	80	7	5	2	87.5	5	4	-	-	TO-204MA	2N4906
2N4914	60	7	5	2	87.5	5	4	-	-	TO-204MA	2N4905
2N4913	40	7	5	2	87.5	5	4	-	-	TO-204MA	2N4904
2N4904	-40	25	-2.5	-2	87.5	-5	4	-	-	TO-204MA	2N4913
2N5783	-40	4 min.	-3.2	-2	10	-3.5	8	0.5 [Ⓞ]	2.5* [Ⓞ]	TO-39	2N5786
RCA30 [♦]	-40	15-150	-1	-4	30	-3	3	0.2	1*	TO-220AB	RCA29
RCA32 [♦]	-40	25 min.	-1	-4	40	-5	3	0.2	1*	TO-220AB	RCA31
RCS30 [♦]	-40	15-150	-1	-4	30	-3	3	0.2	1*	TO-66	RCS29
RCS32 [♦]	-40	25 min.	-1	-4	40	-5	3	0.2	1*	TO-66	RCS31
TIP30	-40	15-150	-1	-4	30	-3	3	0.2	1*	TO-220AB	TIP29
TIP32	-40	25 min.	-1	-4	40	-5	3	0.2	1*	TO-220AB	TIP31
BD240	-45	15 min.	-1	-4	30	-4	3	-	-	TO-220AB	BD239
BD242	-45	25 min.	-1	-4	40	-5	3	-	-	TO-220AB	BD241
2N5782	-50	4 min.	-3.2	-4	10	-3.5	8	0.5 [Ⓞ]	2.5* [Ⓞ]	TO-39	2N5785
2N4905	-60	25	-2.5	-2	87.5	-5	4	-	-	TO-204MA	2N4914
BD240A	-60	15 min.	-1	-4	30	-4	3	-	-	TO-220AB	BD239A
BD242A	-60	10 min.	-3	-4	40	-5	3	-	-	TO-220AB	BD241A
RCA30A [♦]	-60	15-150	-1	-4	30	-5	3	0.2	1*	TO-220AB	RCA29A
RCA32A [♦]	-60	25 min.	-1	-4	40	-5	3	0.2	1*	TO-220AB	RCA31A
RCS30A [♦]	-60	15-150	-1	-4	30	-3	3	0.2	1*	TO-66	RCS29A

*Measured at same current level as h_{FE} unless otherwise indicated

*V_{CE}(sus) @t_r *t_{OFF}

♦Check availability in Europe, the Middle East, and Africa.

ⓄAt I_C = 1A

Power Transistor Selection Charts

P-N-P SILICON POWER TRANSISTORS (Cont'd)

Type No.	V _{CEO(sus)} V	Current Gain			P _T (Max.) W	I _C (Max.) A	f _T MHz	Sw. Times [▲]		Package	n-p-n Complement
		h _{FE}	I _C A	V _{CE} V				t _{ON} μs	t _f		
I_C = -2.5 to -5 A, f_T = 2.5 to 25 MHz (cont'd)											
RCS32A [◆]	-60	25 min.	-1	-4	40	-5	3	0.2	1*	TO-66	RCS31A
TIP30A	-60	15-150	-1	-4	30	-3	3	0.2	1*	TO-220AB	TIP29A
TIP32A	-60	25 min.	-1	-4	40	-5	3	0.2	1*	TO-220AB	TIP31A
2N5781	-65	20-100	-1	-2	10	-3.5	8	0.5	2.5*	TO-39	2N5784
2N4906	-80	25	-2.5	-2	87.5	-5	4	-	-	TO-204MA	2N4915
BD240B	-80	15 min.	-1	-4	30	-4	3	-	-	TO-220AB	BD239B
RD242B	-80	25 min.	-1	-4	40	-5	3	-	-	TO-220AB	BD241B
RCA30B [◆]	-80	15-150	-1	-4	30	-3	3	0.2	1*	TO-220AB	RCA29B
RCA32B [◆]	-80	25 min.	-1	-4	40	-5	3	0.2	1*	TO-220AB	RCA31B
RCS30B [◆]	-80	15-150	-1	-4	30	-3	3	0.2	1*	TO-220AB	RCS29B
RCS32B [◆]	-80	25 min.	-1	-4	40	-5	3	0.2	1*	TO-66	RCS31B
TIP30B	-80	15-150	-1	-4	30	-3	3	0.2	1*	TO-220AB	TIP29C
TIP32B	-80	25 min.	-1	-4	40	-5	3	0.2	1*	TO-220AB	TIP31B
2N6467	-100	5 min.	-4	-4	40	-4	5	-	-	TO-66	2N6465
2N6475	-100	2 min.	-2.5	-4	40	-4	10	-	-	TO-220AB	2N6473
BD240C	-100	15 min.	-1	-4	30	-4	3	-	-	TO-220AB	BD239C
BD242C	-100	10 min.	-3	-4	40	-5	-3	-	-	TO-220AB	BD241C
RCA30C [◆]	-100	15-150	-1	-4	30	-3	3	0.2	1*	TO-220AB	RCA29C
RCA32C [◆]	-100	25 min.	-1	-4	40	-5	3	0.2	1*	TO-220AB	RCA31C
RCS30C [◆]	-100	15-150	-1	-4	30	-3	3	0.2	1*	TO-66	RCS29C
RCS32C	-100	25 min.	-1	-4	40	-5	3	0.2	1*	TO-66	RCS31C
TIP30C	-100	15-150	-1	-4	30	-3	3	0.2	1*	TO-220AB	TIP29C
TIP32C	-100	25 min.	-1	-4	40	-5	3	0.2	1*	TO-220AB	TIP31C
2N6468	-120	5 min.	-4	-4	40	-4	5	-	-	TO-66	2N6466
2N6476	-120	2 min.	-4	-2.5	40	-4	10	-	-	TO-220AB	2N6474
I_C = -6 to -10 A, f_T = 2.5 to 25 MHz											
41501	-25	25 min.	-1	-4	40	-7	10	-	-	TO-220AB	41500
2N6110	-30	2.3 min.	-7	-4	40	-7	10	-	-	TO-220AA	2N6289
2N6111	-30	2.3 min.	-7	-4	40	-7	10	-	-	TO-220AB	2N6288
2N5956	-40	5 min.	-6	-4	40	-6	5	-	-	TO-66	2N6374
RCA42 [◆]	-40	15-150	-3	-4	65	-7	3	0.3*	0.7**	TO-220AB	RCA41
BD244	-45	15 min.	-3	-4	65	-7	3	-	-	TO-220AB	BD243
BD277	-45	30-150	-1.75	-2	70	-7	10	-	-	TO-220AB	-
2N6108	-50	2.3 min.	-7	-4	40	-7	10	-	-	TO-220AA	2N6291
2N6109	-50	2.3 min.	-7	-4	40	-7	10	-	-	TO-220AB	2N6290
2N5955	-60	5 min.	-6	-4	40	-6	5	-	-	TO-66	2N6373
2N5875	-60	4	10	4	150	10	20	-	-	TO-204MA	-
BD244A	-60	15 min.	-3	-4	65	-7	3	-	-	TO-220AB	BD243A
RCA42A [◆]	-60	15-150	-3	-4	65	-7	3	0.3*	0.7**	TO-220AB	RCA41A
2N6106	-70	2.3 min.	-7	-4	40	-7	10	-	-	TO-220AA	2N6293
2N6107	-70	2.3 min.	-7	-4	40	-7	10	-	-	TO-220AB	2N6292
2N5954	-80	5 min.	-6	-4	40	-6	5	-	-	TO-66	2N6372
2N5876	-80	4	10	4	150	10	20	-	-	TO-204MA	-
BD244B	-80	15 min.	-3	-4	65	-7	3	-	-	TO-220AB	BD243B
RCA42B [◆]	-80	15-150	-3	-4	65	-7	3	0.3*	0.7**	TO-220AB	RCA41B
2N6248	-100	5 min.	-10	-4	125	-10	10	-	-	TO-3	-
BD244C	-100	15 min.	-3	-4	65	-7	3	-	-	TO-220AB	BD243C
RCA42C [◆]	-100	15-150	-3	-4	65	-7	3	0.3*	0.7**	TO-220AB	RCA41C
I_C = -12 to -20 A, f_T = 2 to 25 MHz											
2N6469	-40	5 min.	-15	-4	125	-15	5	-	-	TO-3	2N6470
2N6489	-40	5 min.	-15	-4	75	-15	5	-	-	TO-220AB	2N6486
2N6594	-40	5-100	-5	-4	100	-12	2.5	1.9 [■]	1.5 [■]	TO-3	2N6594
2N5879	-60	4	15	4	160	15	4	-	-	TO-204MA	2N5881
2N6246	-60	5 min.	-15	-4	125	-15	5	-	-	TO-3	2N6471
2N6490	-60	5 min.	-15	-4	75	-15	5	-	-	TO-220AB	2N6487
BDX18	-60	20	-4	-4	115	-15	4	-	-	TO-204MA	2N3055
MJ2955	-60	20-70	-4	-4	115	-15	2.5	1.9 [■]	1.5 [■]	TO-3	2N3055
2N6247	-80	5 min.	-15	-4	125	-15	5	-	-	TO-3	2N6472
2N6491	-80	5 min.	-15	-4	75	-15	5	-	-	TO-220AB	2N6488
RCS618	-80	20-70	-5	-4	115	-15	25	1.9 [■]	1.5 [■]	TO-3	RCS617
2N5880	-80	4	15	4	160	15	4	-	-	TO-204MA	2N5882
RCA9116E	-100	10	-7.5	-2	200	-20	2	-	-	TO-204MA	RCA8638E
RCA9116D	-120	10	-10	-2	200	-20	2	-	-	TO-204MA	RCA8638D
2N6609	-140	15	-8	-4	150	-16	2	-	-	TO-204MA	RCA3773
MJ15004	-140	10	-10	-2	250	-20	2	-	-	TO-204MA	MJ15003
MJ15002	-140	25	4	2	200	-15	2	-	-	TO-204MA	MJ15001
RCA9116C	-140	10	-10	-2	200	-20	2	-	-	TO-204MA	RCA8638C
RCS618	-80	20	-5	-4	115	-15	2.5	-	-	TO-204MA	RCS617

[▲]Measured at same current level as h_{FE} unless otherwise indicated

[■]At I_C = 6A @ t_r *t_{OFF} [■]At I_C = 2A

[◆]Check availability in Europe, the Middle East, and Africa.

Power Transistor Selection Charts

N-P-N MONOLITHIC DARLINGTON TRANSISTORS

Type No.	V _{CEO(sus)} V	Current Gain			P _T (Max.) W	I _C (Max.) A	Package	p-n-p Complement
		hFE	I _C A	V _{CE} V				
I_C (Max.) = 4 A, f_{UNITY GAIN} = 20 MHz for all types								
RCS683	40	1000 min.	2	3	10	4	TO-39	—
RCS683A	60	1000 min.	2	3	10	4	TO-39	—
RCS683B	80	1000 min.	2	3	10	4	TO-39	—
I_C (Max.) = 8 A, f_{UNITY GAIN} = 20 MHz for all types								
2N6055	60	750-18,000	4	3	100	8	TO-3	—
2N6300	60	100	8	3	75	8	TO-213MA	—
RCA120♦	60	1000 min.	3	3	65	8	TO-220AB	RCA125
TIP120	60	1000 min.	3	3	65	8	TO-220AB	TIP125
RCA1000	60	1000 min.	3	3	90	8	TO-3	—
2N6056	80	750-18,000	4	3	100	8	TO-3	—
2N6301	80	100	8	3	75	8	TO-213MA	—
2N6530	80	1000-10,000	5	3	65	8	TO-220AB	—
2N6534	80	1000-10,000	5	3	36	8	TO-66	—
RCA121♦	80	1000 min.	3	3	65	8	TO-220AB	RCA126
RCA1001	80	1000 min.	3	3	90	8	TO-3	—
TIP121♦	80	1000 min.	3	3	65	8	TO-220AB	TIP126
2N6531	100	500-10,000	3	3	65	8	TO-220AB	—
2N6532	100	1000-10,000	5	3	65	8	TO-220AB	—
2N6536	100	500-10,000	3	3	36	8	TO-66	—
2N6536	100	1000-10,000	5	3	36	8	TO-66	—
RCA122♦	100	1000 min.	3	3	65	8	TO-220AB	—
TIP122	100	1000 min.	3	3	65	8	TO-220AB	TIP127
2N6533	120	1000-10,000	3	3	65	8	TO-220AB	—
2N6537	120	1000-10,000	3	3	36	8	TO-66	—
I_C (Max.) = 10 A, f_{UNITY GAIN} = 20 MHz for all types								
2N6383	40	1000-20,000	5	3	100	10	TO-3	RCA8350
2N6386	40	1000-10,000	3	3	65	10	TO-220AB	RCA8203
BDX33	45	750 min.	4	3	70	10	TO-220AB	BDX34
BDX83	45	1000 min.	5	3	125	10	TO-3	—
2N6384	60	1000-20,000	5	3	100	10	TO-3	RCA8350A
2N6387	60	1000-20,000	5	3	65	10	TO-220AB	RCA8203A
BDX33A	60	750 min.	4	3	70	10	TO-220AB	BDX34A
BDX83A	60	1000 min.	5	3	125	10	TO-3	—
2N6385	80	1000-20,000	5	3	100	10	TO-3	RCA8350B
2N6388	80	1000-20,000	5	3	65	10	TO-220AB	RCA8203B
BDX33B	80	750 min.	3	3	70	10	TO-220AB	RDX34B
BDX83B	80	1000 min.	5	3	125	10	TO-3	—
BDX33C	100	750 min.	3	3	70	10	TO-220AB	BDX34C
BDX83C	100	1000 min.	5	3	125	10	TO-3	—
BDX33D	120	750 min.	3	3	70	10	TO-220AB	—

N-P-N MONOLITHIC DARLINGTON TRANSISTORS

Type No.	V _{CEO(sus)} V	Current Gain			P _T (Max.) W	I _C (Max.) A	Package	n-p-n Complement
		hFE	I _C A	V _{CE} V				
I_C = -8 A, f_{UNITY GAIN} = 20 MHz for all types								
RCA8203	-40	1000-20,000	-3	-3	65	-8	TO-220AB	2N6386
TIP125	-60	1000 min.	-3	-3	65	-8	TO-220AB	TIP120
RCA125♦	-60	1000 min.	-3	-3	65	-8	TO-220AB	RCA120
TIP126	-80	1000 min.	-3	-3	65	-8	TO-220AB	TIP121
RCA126♦	-80	1000 min.	-3	-3	65	-8	TO-220AB	RCA121
TIP127	-100	1000 min.	-3	-3	65	-8	TO-220AB	TIP122

♦Check availability in Europe, the Middle East, and Africa .

Power Transistor Selection Charts

P-N-P MONOLITHIC DARLINGTON TRANSISTORS (cont'd)

Type No.	V _{CEO} (sus) V	Current Gain			P _T (Max.) W	I _C (Max.) A	Package	n-p-n Complement
		h _{FE}	I _C A	V _{CE} V				
I_C (Max.) = 10 A, f_{UNITY GAIN} = 20 MHz for all types								
2N6648	-40	1000,20,000	-3	-3	70	-10	TO-204MA	2N6383
2N6666	-40	1000	-3	-3	65	-8	TO-220AB	2N6386
RCA8350	-40	1000-20,000	-5	-5	70	-10	TO-3	2N6383
BDX34C	-45	750 min.	-4	-3	70	-10	TO-220AB	BDX33
2N6649	-60	1000-20,000	-3	-3	70	-10	TO-204MA	2N6384
2N6667	-60	1000	-5	-3	65	-10	TO-220AB	2N6387
BDX34A	-60	750 min.	-4	-3	70	-10	TO-220AB	BDX33A
RCA8203A	-60	1000-20,000	-5	-3	65	-10	TO-220AB	2N6387
RCA8350A	-60	1000-20,000	-5	-3	70	-10	TO-3	2N6384
2N6650	-80	1000-20,000	-3	-3	70	-10	TO-204MA	2N6385
2N6668	-80	1000	-5	-3	65	-10	TO-220AB	2N6388
BDX34B	-80	750 min.	-3	-3	70	-10	TO-220AB	BDX33B
RCA8203B	-80	1000-10,000	-5	-3	65	-10	TO-220AB	2N6388
RCA8350B	-80	1000-20,000	-5	-3	70	-10	TO-3	2N6385
BDX34C	-100	750 min.	-3	-3	70	-10	TO-220AB	BDX33C

Transistors for Audio-Amplifier Applications

RCA Types	NPN or PNP	Package	H _{FE}	I _C /V _{CE}	V _{CER}	P _T
Full Complementary Output Darlington Pairs						
2N6385	NPN	TO-3	1000	5A/3V	80V	100W
2N6650	PNP	TO-3	1000	-5A/3V	80V	70W
BDX33	NPN	TO-220	750	4A/3V	100V	70W
BDX34	PNP	TO-220	750	-4A/-3V	-100V	70W
RCA1C15	PNP	TO-220	1000	5A/3V	80V	65W
RCA1C16	NPN	TO-220	1000	-5A/-3V	-80V	65W
RCA900	PNP	TO-3	1000	-5A/-3V	-60V	90W
RCA1000	NPN	TO-3	1000	5A/3V	60V	90W
TA9117	PNP	TO-3	750	-10A/-3V	-100V	160W
TA9118	NPN	TO-3	750	10A/3V	100V	160W

RCA Types	NPN or PNP	Package	H _{FE}	I _C /V _{CE}	V _{CER}	P _T
Full Complementary Output Transistor Pairs						
2N3055	NPN	TO-3	20	4A/4V	70V	115W
BDX18	PNP	TO-3	20	-4A/-4V	-70V	115W
2N6292	NPN	TO-220	30	3A/4V	80V	40W
2N6107	PNP	TO-220	30	-3A/-4V	-80V	40W
2N6488	NPN	TO-220	20	5A/4V	85	75W
2N6491	PNP	TO-220	20	-5A/-4V	-85V	75W
BD239-243	NPN	TO-220	15	3A/4V	100V	70W
BD240-244	PNP	TO-220	15	-3A/-4V	-100V	70W
RCA1A05	PNP	TO-39	50	-0.15A/-4V	-75V	7W
RCA1A06	NPN	TO-39	50	0.15A/4V	75V	5W
RCA1C05	NPN	TO-220AB	20	3A/4V	50V	40W
RCA1C06	PNP	TO-220AB	20	-3A/-4V	-50V	40W
RCA1C07	NPN	TO-220	20	4A/4V	65	75W
RCA1C08	PNP	TO-220	20	-4A/4V	-65	75W
RCA1C10	NPN	TO-220	50	1.5A/4V	40	40W
RCA1C11	PNP	TO-220	50	-1.5A/-4V	-40	40W
RCP700	NPN	TO-202	50	0.5A/4V	100V	10W
RCP701	PNP	TO-202	50	-0.5A/4V	-100V	10W
RCS617	NPN	TO-3	20	5A/4V	85V	115W
RCS618	PNP	TO-3	20	-5A/4V	-85V	115W
TA8638	NPN	TO-3	15	8A/4V	140V	200W
TA9116	PNP	TO-3	15	-8A/4V	-140V	200W

RCA Types	NPN or PNP	Package	H _{FE}	I _C /V _{CE}	V _{CER}	P _T
Quasi Complementary Output Transistors						
2N3055	NPN	TO-3	20	4A/4V	70V	115W
2N3055 (Hometaxial)	NPN	TO-3	20	5A/4V	80V	150W
2N3442	NPN	TO-3	20	3A/2V	150V	150W
2N3772	NPN	TO-3	15	10A/4V	70V	250W
2N3773	NPN	TO-3	15	8A/4V	160V	250W
2N5298	NPN	TO-220	20	5A/4V	75V	75W
2N5496	NPN	TO-220	20	3.5A/4V	70V	36W
2N6103	NPN	TO-3	20	5A/4V	75V	75W
2N6292	NPN	TO-220	30	2.5A/4V	80V	40W
2N6488	NPN	TO-220	20	5A/4V	90V	75W
2N6510	NPN	TO-3	10	4A/3V	300V	120W
BUX18	NPN	TO-3	10	4A/3V	375V	120W

RCA Types	NPN or PNP	Package	H _{FE}	I _C /V _{CE}	V _{CER}	P _T
Quasi Complementary Output Transistors (Cont'd)						
RCA1A03	NPN	TO-39	70	0.3A/4V	95V	10W
RCA1A04	PNP	TO-39	70	-0.3A/-4V	-95V	10W
RCA1A05	PNP	TO-39	50	-0.15A/-4V	-75V	7W
RCA1A06	NPN	TO-39	50	0.15A/4V	75V	5W
RCA1B01	NPN	TO-3	20	4A/4V	95V	115W
RCA1B04	NPN	TO-3	15	2A/5V	200V	150W
RCA1B05	NPN	TO-3	15	2A/5V	250V	150W
RCA1B06	NPN	TO-3	10	4A/4V	100V	150W
RCA1B09	NPN	TO-3	40	2A/5V	250V	150W
RCA1C03	NPN	TO-220	50	1A/4V	100V	40W
RCA1C04	PNP	TO-220	50	-1A/-4V	-100V	40W
RCA1C09	NPN	TO-220	20	4A/4V	65V	75W
RCA1C12	NPN	TO-220	40	1A/2V	120V	40W
RCA1C13	PNP	TO-220	40	-1A/2V	-120V	40W
RCA1C14	NPN	TO-220	20	3A/4V	40V	50W

Complementary Driver Pairs/Predrivers

2N2102	NPN	TO-39	25	0.1A/5V	100V	5W
2N3440	NPN	TO-39	40	20 mA/10V	400V	10W
2N4036	PNP	TO-39	50	0.15A/10V	65V	7W
2N5320	NPN	TO-39	40	0.5A/4V	90V	10W
2N5322	PNP	TO-39	40	-0.5A/-4V	-90V	10W
2N5415	PNP	TO-39	20	-50mA/-10V	-300V	10W
BD239-243	NPN	TO-220	15	3A/4V	100V	70W
BD240-244	PNP	TO-220	15	-3A/-4V	-100V	70W
RCA1A01	NPN	TO-39	40	0.01A/4V	70V	5W
RCA1A08	PNP	TO-39	30	-0.1A/-10V	-50V	7W
RCA1A09	NPN	TO-39	20	0.01A/10V	175V	10W
RCA1A10	PNP	TO-39	40	-0.01A/-10V	-175V	10W
RCA1A15	NPN	TO-39	20	0.01A/10V	100V	10W
RCA1A16	PNP	TO-39	40	-0.01A/-10V	-100V	10W
RCA1E02	NPN	TO-66	30	0.3A/2V	175V	35W
RCA1E03	PNP	TO-66	30	-0.3A/-2V	-175V	35W
RCP131	NPN	TO-202	50	50mA/10V	350V	10W
RCP700	NPN	TO-202	50	0.5A/4V	100V	10W
RCP701	PNP	TO-202	50	-0.5A/4V	-100V	10W

Protection Circuit Types

RCA1A18	NPN	TO-39	40	0.01A/4V	10V	5W
RCA1A19	PNP	TO-39	40	-0.01A/-4V	-10V	7W

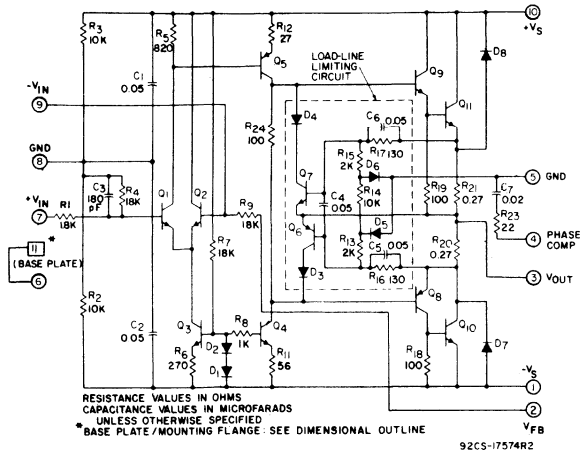
Input Device Types

RCA1A02	PNP	TO-39	30	-0.1A/-10V	-50V	7W
RCA1A07	NPN	TO-39	50	0.01A/10V	40V	5W
RCA1A11	NPN	TO-39	40	0.01A/10V	175V	10W
RCA1A17	NPN	TO-39	40	0.01A/4V	90V	5W

Power Hybrid Comparison Chart

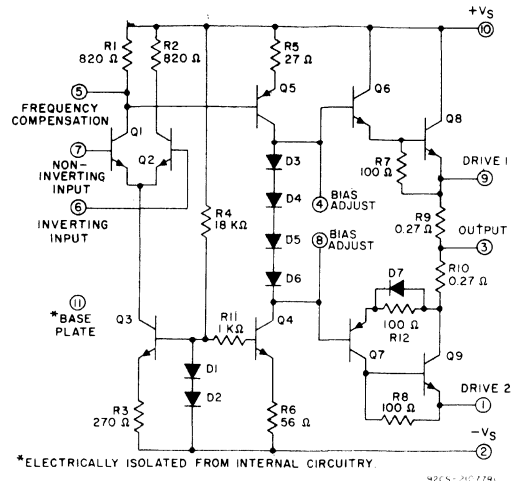
Multi-Purpose High-Power Operational Amplifiers

HC2000H*



Schematic diagram of type HC2000H operational amplifier.

HC2500



Schematic diagram of type HC2500 operational amplifier.

HC2000H* – Applications

Motor control, magnetic-deflection amplifiers, solenoid driver, low-frequency oscillator amplifier, voltage regulators, constant current source, inverting and non-inverting unity-gain amplifier.

HC2500 – Applications

Low-distortion, high-power amplifiers for audio and other end uses where internal overload protection is not required.

Ratings and Features for HC2000H* and HC2500

Ratings:

SUPPLY VOLTAGE:

Between leads 1 and 10 75 V

OUTPUT CURRENT (peak) 7 A

OPERATING TEMPERATURE RANGE ... -55 to +150°C

Features:

Bandwidth: 30 kHz at 60 W

High power output: up to 100 W (rms)

Single or split power supply:

30 to 75 V single, ±15 to ±37.5 V split

COMPARISON CHART

TYPE	IM DIST. @ 200 mW	OUTPUT PROTECTION NETWORK	OPERATING MODE	FREQUENCY COMPENSATION	COMMUTATING DIODES
HC2000H*	0.6%	YES	CLASS B	LC FILTER ON OUTPUT	YES
HC2500	0.06%	NO	CLASS AB	CAPACITOR ON SIGNAL TERMINALS	NO

Socket for both types: RCA part DG-293A, or

Electronic Essentials, 210 Elizabeth St., New York, N.Y. 10012, Part No. MS5-1000

* HC2000H also available to MIL-spec as HC2000H/1, 2, 3, 4.

(see data bulletin file no. 789, or pg. 404 in the "High-Reliability Devices" DATABOOK SSD-230.)

RF Power Transistor Selection Charts

Type	Package Type	Collector-Supply Voltage (V)	Frequency (MHz)	Min. Output Power (W) or Noise Figure (dB)	Data Sheet File No.
2N2857	TO-72	6-15(V _{CE})	450	NF = 4.5	61
2N2876	TO-60	28	50	10	32
2N3229	TO-60	50	50	15	50
2N3375	TO-60	28	400	3	386
2N3478	TO-72	6-15(V _{CE})	200	NF = 4.5	77
2N3553	TO-39	28	175	2.5	386
2N3600	TO-72	6-15(V _{CE})	200	NF = 4.5	83
2N3632	TO-60	28	175	13.5	386
2N3733	TO-60	28	400	10	72
2N3839	TO-72	6-15(V _{CE})	450	NF = 3.9	229
2N3866	TO-39	28	400	1	80
2N3866A	TO-39	28	800	1	-
2N4012	TO-60	28	1000 (trippler)	2.5	90
2N4427	TO-39	12	175	1	228
2N4440	TO-60	28	400	5	217
2N4932	TO-60	13.5	88	12	249
2N4933	TO-60	24	88	20	249
2N5070	TO-60	28	30	25 (PEP)	268
2N5071	TO-60	24	76	24	269
2N5090	TO-60	28	400	1.2	270
2N5102	TO-60	24	136	15	279
2N5109	TO-39	15	200	NF = 3	281
2N5179	TO-72	6(V _{CE})	200	NF = 4.5	288
2N5180	TO-72	10(V _{CE})	200	NF = 4.5	289
2N5913	TO-39	12	470	2	423
2N6670	TO-202AB	12.5	27	4	1091
40280	TO-39	13.5	175	1	68
40290	TO-39	12.5	135	2	70
40291	TO-60	12.5	135	2	70
40292	TO-60	12.5	135	6	70
40340	TO-60	13.5	50	25	74
40341	TO-60	24	50	30	74
40606	Premium high-reliability version of 2N3632				600
40608	TO-39	15	200	NF = 3	356
40894	TO-72	12	200	rf amp.	548
40895	TO-72	12	200	mixer	548
40896	TO-72	12	200	Osc.	548
40897	TO-72	12	10.7	if amp.	548
40936	TO-60	28	30	20 (PEP)	551
40964	TO-39	12	470	0.4	581
40965	TO-39	12	470	0.5	581
41024	TO-39	28	1000	1	658

Type	Operating Frequency (MHz)	Min. Output Power (W)	Collector-Supply Voltage (V)	Min. Power Gain
For VHF and UHF Mobile-Radio Applications				
2N4427	175	1	12	10
2N5913	175	1.75	12.5	12.4
40280	175	1	13.5	9
40964	470	0.4	12	6
40965	470	0.5	12	7
For Aircraft-Radio Applications				
40290	118-136	2	12.5	6
40291	118-136	2	12.5	6
40292	118-136	6	12.5	4.8
2N5102	118-136	15	24	4
For Single-Sideband Applications and For Military Communications				
40936	30	20 (PEP)	28	13
2N5070	30	25 (PEP)	28	13
2N5071	76	24	24	9
2N3866	400	1	28	10
For CB-Radio Applications				
2N6670	27	4	12.5	10
For CATV/MATV and Small-Signal Low-Noise Applications				
2N3478	200	4.5	6.15	11.5
2N5179	200	4.5	6	15
2N5109	200	3	15	11
40608	200	3	15	11
40894	200	3	12	15
40895	200	-	12	15
40896	200	-	12	15
2N3600	200	4.5	15	17
40897	200	-	12	18
2N2857	450	4.5	6	12.5
2N3839	450	3.9	6	12.5
For Microwave Applications				
41024	1000	5	28	5
Minimum Output Power = 1 W Collector Efficiency = 35%				

Triac Product Matrix

RCA Triacs		TO-205MA/TO-5 Modified				Mod. TO-205MA/TO-5 With Heat Radiator				TO-202AB VERSATAB		
Standard	I _T (RMS)	2.5A	2.5A	2.5A	2.5A	2.5A	2.5A	2.5A	2.5A	2.5A	2.5A	
	I _{TSM} (60 Hz)	25A	25A	25A	25A	25A	25A	25A	25A	25A	25A	
	V _{DROM} (V)	50	T2300F	T2301F	T2302F	T2303F	T2310F	T2311F	T2312F	T2313F	T2320F	T2327F
		100	T2300A	T2301A	T2302A	2N5754	T2310A	T2311A	T2312A	T2313A	T2320A	T2327A
		200	T2300B	T2301B	T2302B	2N5755	T2310B	T2311B	T2312B	T2313B	T2320B	T2327B
		300									T2320C	T2327C
		400	T2300D	T2310D	T2302D	2N5756	T2310D	T2311D	T2312D	T2313D	T2320D	T2327D
		500									T2320E	T2327E
	600				2N5757				T2313M			
	I _{GT} (mA)	I ⁺ , III ⁻	3	4	10	25	3	4	10	25	3	5
I ⁻ , III ⁺		3	4	10	40	3	4	10	40	3	5	
V _{GT} (V)	All Modes	2.2	2.2	2.2	2.2	2.2	2.2	2.2	2.2	2.2	2.2	
Zero Voltage Switch	V _{DROM} (V)	100			T2306A				T2316A			
		200			T2306B				T2316B			
		400			T2306D				T2316D			
	I _{GT} (mA)	I ⁺ , III ⁺			45				45			
V _{GT} (V)	I ⁺ , III ⁺			1.5				1.5				
400-Hz Operation	I _T (RMS)			0.5A	0.5A							
	V _{DROM} (V)	200		T2304B	T2305B							
		400		T2304D	T2305D							
	I _{GT} (mA)	I ⁺ , III ⁻			10	25						
		I ⁻ , III ⁺			10	40						
V _{GT} (V)	All Modes			2.2	2.2							

RCA Triacs		TO-202AB VERSATAB		TO-213MA/ TO-66		TO-213MA/ TO-66 With Heat Radiator	TO-220AB VERSAWATT					
Standard	I _T (RMS)	2.5A	2.5A	6A	15A	6A	6A	6A	8A	8A	8A	ISOWATT* 8A
	I _{TSM} (60 Hz)	25A	25A	100A	100A	100A	60A	80A	100A	100A	100A	100A
	V _{DROM} (V)	50	T2322F	T2323F					T2801F	T2800F	T2802F	T2850F
		100	T2322A	T2323A					T2801A	T2800A	T2802A	T2850A
		200	T2322B	T2323B	T2700B	T4700B	T2710B	T2500B	T2801B	T2800B	T2802B	T2850B
		300	T2322C	T2323C					T2801C	T2800C	T2802C	
		400	T2322D	T2323D	T2700D	T4700D	T2710D	T2500D	T2801D	T2800D	T2802D	T2850D
		500	T2322E	T2323E					T2801E	T2800E	T2802E	T2850E
	600								T2800M	T2802M		
	I _{GT} (mA)	I ⁺ , III ⁻	10	25	25	30	25	25	80	25	50	25
I ⁻ , III ⁺		10	40	40	80	40	60	-	60	-	60	
V _{GT} (V)	All Modes	2.2	2.2	2.2	2.5	2.2	2.5	4.0 [▲]	2.5	2.5 [▲]	2.5	
Zero Voltage Switch	V _{DROM} (V)	100										
		200			T2706B	T4706B	T2716B	T2506B			T2806B	T2856B
		400			T2706D	T4706D	T2716D	T2506D			T2806D	T2856D
	I _{GT} (mA)	I ⁺ , III ⁺			45	45	45	45			45	45
	V _{GT} (V)	I ⁺ , III ⁺			1.5	1.5	1.5	1.5			1.5	1.5

*ISOWATT – Mounting tab electrically isolated from electrodes

▲I⁺, III⁻ only

Triac Product Matrix

RCA Triacs		TO-220AB VERSAWATT					Press-Fit (TO-203AA)			Stud			
Standard	I _T (RMS)	8A	12A	12A	12A	12A		10A	15A		10	15	
	I _{TSM} (60 Hz)	100A	120A	120A	120A	100A		100A	100A		100A	100A	
	V _{DROM} (V)	50							T4101F	T4100F		T4111F	T4110F
		100											
		200	T2851B	2N6342A	2N6346A	SC149B	TIC236B		2N5567	2N5571		2N5569	2N5573
		300	T2851C										
		400	T2851D	2N6343A	2N6347A	SC149D	TIC236D		2N5568	2N5572		2N5570	2N5574
		500	T2851E			SC149E			T4101E	T4100E		T4111E	T4110E
	I _{GT} (mA)	I ⁺ , III ⁻	80	50	50	50	50		25	50		25	50
		I ⁻ , III ⁺	-	-	75	50*	50*		40	80		40	80
V _{GT} (V)	All Modes	3	2	2.5	2.5	2.5		2.5	2.5		2.5	2.5	
Zero Voltage Switch	V _{DROM} (V)	200						T4107B	T4106B		T4117B	T4116B	
		400						T4107D	T4106D		T4117D	T4116D	
		600						T4107M	T4106M				
	I _{GT} (mA)	I ⁺ , III ⁺						45	45		45	45	
V _{GT} (V)	All Modes							1.5	1.5		1.5	1.5	
400-Hz Operation	I _T (RMS)						6A	10A	15A	6A	10A	15A	
	V _{DROM} (V)	200					T4105B	T4104B	T4103B	T4115B	T4114B	T4113B	
		400					T4105D	T4104D	T4103D	T4115D	T4114D	T4113D	
	I _{GT} (mA)	I ⁺ , III ⁻						50	50	50	50	50	50
		I ⁻ , III ⁺						80	80	80	80	80	80
V _{GT} (V)	All Modes						2.5	2.5	2.5	2.5	2.5	2.5	

* I⁻ only

RCA Triacs		Isolated Stud		With flex. leads, encap. on iso-lated-stud		Press-Fit				TO-220AB VERSAWATT		
						Isolated on TO-3 flange		With flex. leads, encap., isolated on TO-3 flange				
Standard	I _T (RMS)	10A	15A	10A	15A	10A	15A	10A	15A	15A	15A	
	I _{TSM} (60 Hz)	100A	100A	100A	100A	100A	100A	100A	100A	150A	150A	
	V _{DROM} (V)	50	T4121F	T4120F	T4131F	T4130F	T4141F	T4140F	T4151F	T4150F		
		100										
		200	T4121B	T4120B	T4131B	T4130B	T4141B	T4140B	T4151B	T4150B	MAC15-4	MAC15A-4
		400	T4121D	T4120D	T4131D	T4130D	T4141D	T4140D	T4151D	T4150D	MAC15-6	MAC15A-6
		500	T4121E	T4120E	T4131E	T4130E	T4141E	T4140E	T4151E	T4150E		
		600	T4121M	T4120M	T4131M	T4130M	T4141M	T4140M	T4151M	T4150M	MAC15-8	MAC15A-8
	I _{GT} (mA)	I ⁺ , III ⁻	25	50	25	50	25	50	25	50	50	50
		I ⁻ , III ⁺	40	80	40	80	40	80	40	80	-	75
V _{GT} (V)	All Modes	2.5	2.5	2.5	2.5	2.5	2.5	2.5	2.5	2	2.5	
Zero Voltage Switch	V _{DROM} (V)	200	T4127B	T4126B								
		400	T4127D	T4126D								
		600	T4127M	T4126M								
	I _{GT} (mA)	I ⁺ , III ⁺	45	45								
V _{GT} (V)	All Modes	1.5	1.5									

Triac Product Matrix

RCA Triacs		TO-220AB VERSAWATT				Press-Fit		Stud			Isolated Stud		
Standard	I _T (RMS)	15A	16A	16A	16A	30A	40A	30A		40A	30A	40A	
	I _{TSM} (60 Hz)	150A	100A	150A	150A	300A	300A	300A		300A	300A	300A	
	V _{DROM} (V)	50			T6000F	T6001F	T6401F	T6402F	T6411F		T6412F	T6421F	T6420F
		100											
		200	SC151B	TIC246B	T6000B	T6001B	T6401B	2N5441	T6411B		2N5444	T6421B	T6420B
		300			T6000C	T6001C							
		400	SC151D	TIC246D	T6000D	T6001D	T6401D	2N5442	T6411D		2N5445	T6421D	T6420D
		500	SC151E		T6000E	T6001E	T6401E	T6402E	T6411E		T6412E	T6421E	T6420E
	600	SC151M		T6000M	T6001M	T6401M	2N5443	T6411M		2N5446	T6421M	T6420M	
	I _{GT} (mA)	I ⁺ , III ⁻	50	50	50	80	50	50	50		50	50	50
I ⁻ , III ⁺		50 [•]	50 [•]	80	—	80	80	80		80	80	80	
V _{GT} (V)	All Modes	2.5	2.5	2.5	3	2.5	2.5	2.5		2.5	2.5	2.5	
Zero Voltage Switch	V _{DROM} (V)	200			T6006B		T6407B	T6406B	T6417B		T6416B	T6427B	T6426B
		300			T6006C								
		400			T6006D		T6407D	T6406D	T6417D		T6416D	T6427D	T6426D
		500			T6006E								
		600			T6006M		T6407M	T6406M	T6417M		T6416M		T6426M
	I _{GT} (mA)	I ⁺ , III ⁺			45		45	45	45		45	45	45
V _{GT} (V)	All Modes			1.5		1.5	1.5	1.5		1.5	1.5	1.5	
400-Hz Operation	I _T (RMS)					25A	40A	25A	25A	40A			
	V _{DROM} (V)	200					T6405B	T6404B	T6415B	2N5806	T6414B		
		400					T6405D	T6404D	T6415D	2N5807	T6414D		
		500								2N5808			
		600								2N5809			
	I _{GT} (mA)	I ⁺ , III ⁻					80	80	80	80	80		
I ⁻ , III ⁺						120	120	120	150 [■]	120			
V _{GT} (V)	All Modes					3	3	3	2.5 [▲]	3			

• I⁻ mode only

▲ 4 V for 111⁺ mode

■ 80 mA for I⁻ mode

RCA Triacs		Press-Fit								
		With flex. leads, encap. on isolated-stud		Isolated on TO-3 flange		With flex. leads, encap., isolated on TO-3 flange		Overmold Stud		
Standard	I _T (RMS)	30A	40A	30A	40A	30A	40A	60A	80A	
	I _{TSM} (60 Hz)	300A	300A	300A	300A	300A	300A	600A	850A	
	V _{DROM} (V)	50	T6431F		T6441F	T6440F	T6451F	T6450F	T8411F	T8410F
		100								
		200	T6431B	T6430B	T6441B	T6440B	T6451B	T6450B	T8411B	T8410B
		300								
		400	T6431D	T6430D	T6441D	T6440D	T6451D	T6450D	T8411D	T8410D
		500	T6431E		T6441E	T6440E	T6451E	T6450E	T8411E	T8410E
	600	T6431M	T6430M	T6441M	T6440M	T6451M	T6450M	T8411M	T8410M	
	I _{GT} (mA)	I ⁺ , III ⁻	50	50	50	50	50	50	75	75
I ⁻ , III ⁺		80	80	80	80	80	80	150	150	
V _{GT} (V)	All Modes	2.5	2.5	2.5	2.5	2.5	2.5	2.8	2.5	

SCR Product Matrix

RCA SCR's	TO-8	TO-202AB VERSATAB						TO-220AB VERSAWATT			TO-213MA/ TO-66	
		4A	4A	4A	4A	4A	4A	4A	4A	4A	5A	
I _T (RMS)	2A	4A	4A	4A	4A	4A	4A	4A	4A	4A	5A	
I _{TSM} (60 Hz)	60A	20A	15A	30A	20A	20A	20A	35A	35A	35A	60A	
V _{DROM}	15	C106Q	C107Q	C108Q	S106Q	S107Q	S108Q	S2060Q	S2061Q	S2062Q		
V _{RROM} (V)	25											
	30	C106Y	C107Y	C108Y	S106Y	S107Y	S108Y	S2060Y	S2061Y	S2062Y		
	50	C106F	C107F	C108F	S106F	S107F	S108F	S2060F	S2061F	S2062F		
	100	C106A	C107A	C108A	S106A	S107A	S108A	S2060A	S2061A	S2062A		
	150											
	200	2N3528	C106B	C107B	C108B	S106B	S107B	S108B	S2060B	S2061B	S2062B	2N3228
	250											
	300							S2060C	S2061C	S2062C		
	400	2N3529	C106D	C107D	C108D	S106D	S107D	S108D	S2060D	S2061D	S2062D	2N3525
	500		C106E	C107E	C108E	S106E	S107E	S108E	S2060E	S2061E	S2062E	
	600	2N4102	C106M	C107M	C108M	S106M	S107M	S108M	S2060M	S2061M	S2062M	2N4101
I _{GT} (mA)	15	0.2	0.5	0.2	0.2	0.5	2	0.2	0.5	2	15	
V _{GT} (V)	2	0.8	0.8	0.8	0.8	0.8	0.8	0.8	0.8	0.8	2	

RCA SCR's	TO-213MA/TO-66						TO-213MA/ TO-66 With Heat Rad.	TO-220AB VERSAWATT			
	FTO*	FTO*	FTO*	FTO*	FTO*	FTO*	FTO*	FTO*	FTO*	FTO*	
I _T (RMS)	5A	5A	5A	5A	5A	5A	5A	5A	5A	5A	
I _{TSM} (60 Hz)	80A	80A	80A	75A(I _{PM})	80A	80A	80A	80A	80A	80A	
V _{DROM}	100		S3704A					S3714A			
V _{RROM} (V)	200	S3700B	S3704B				S2710B	S3714B	S5800B	S5801B	S5802B
	250								S5800C	S5801C	S5802C
	300										
	400	S3700D	S3704D				S2710D	S3714D	S5800D	S5801D	S5802D
	500	S3706E							S5800E	S5801E	S5802E
	600	S3705M	S3700M	S3704M	S3701M		S2710M	S3714M	S5800M	S5801M	S5802M
	700			S3704S		S3702S		S3714S			
	750						S3703SF				
I _{GT} (mA)	30	40	40	35	45	40	15	40	50	50	50
V _{GT} (V)	4	3.5	3.5	4	4	4	2	3.5	2.5	2.5	2.5

RCA SCR's	Low-Pro- file Mod. TO-205MA/ TO-5	TO-205MA/ TO-5 with Heat Rad.	TO-205MA/ TO-5 with Heat Spreader	TO-220AB VERSAWATT				TO-204MA/ TO-3	Press-Fit TO-203AA		
I _R (RMS)	7A	3.3A	7A	8A	10A	12	16	12.5	20A	35A	
I _{TSM} (60 Hz)	100A	100A	100A	100A	100A	125	160	200A	200A	350A	
V _{DROM}	50			S122F	S2800F	2N6394	2N6400				
V _{RROM} (V)	100			S122A	S2800A	2N6395	2N6401	2N3668	S6200A	2N3870	
	150										
	200	S2600B	S2610B	S2620B	S122B	S2800B	2N6396	2N6402	2N3669	S6200B	2N3871
	250										
	300				S122C	S2800C	S6000C	S6100C			
	400	S2600D	S2610D	S2620D	S122D	S2800D	2N6397	2N6403	2N3670	S6200D	2N3872
	500				S122E	S2800E	S6000E	S6100E			
	600	S2600M	S2610M	S2620M	S122M	S2800M	2N6398	2N6406	2N4103	S6200M	2N3873
	700				S122S	S2800S	S6000S	S6100S			
I _{GT} (mA)	15	15	15	25	15	30	30	40	15	40	
V _{GT} (V)	1.5	1.5	1.5	1.5	1.5	1.5	1.5	2	2	2	

*FTO – Fast Turn-Off.

◆Check availability in Europe, the Middle East, and Africa.

SCR Product Matrix

RCA SCR's	Stud		Isolated Stud		With flex. leads, encap. on isolated stud		Press-Fit Isolated on TO-3 flange		With flex. leads, encap., isolated on TO-3 flange		
	20A	35A	20A	35A	20A	35A	20A	35A	20A	35A	
I _T (RMS)	20A	35A	20A	35A	20A	35A	20A	35A	20A	35A	
I _{TSM} (60 Hz)	200A	350A	200A	350A	200A	350A	200A	350A	200A	350A	
V _{DROM}	100	S6210A	2N3896	S6220A	S6420A	S6230A	S6430A	S6240A	S6440A	S6250A	S6450A
V _{RROM} (V)	200	S6210B	2N3897	S6220B	S6420B	S6230B	S6430B	S6240B	S6440B	S6250B	S6450B
	400	S6210D	2N3898	S6220D	S6420D	S6230D	S6430D	S6240D	S6440D	S6250D	S6450D
	600	S6210M	2N3899	S6220M	S6420M	S6230M	S6430M	S6240M	S6440M	S6250M	S6450M
I _{GT} (mA)	15	40	15	40	15	40	15	40	15	40	
V _{GT} (V)	2	2	2	2	2	2	2	2	2	2	

RCA SCR's	TO-208MA/TO-48						Overmold Stud		Overmold Isolated Stud		
	16A	25A	Pulse Modulator 35A	FTO* 35A	FTO* 35A	FTO* 40A*	75A	75A	75A	75A	
I _T (RMS)	16A	25A	35A	35A	35A	40A*	75A	75A	75A	75A	
I _{TSM} (60 Hz)	125A	150A	150A	180A	180A	400A	750A	750A	750A	750A	
V _{DROM}	15										
V _{RROM} (V)	25	2N1842A	2N681								
	30										
	50	2N1843A	2N682			2N3654					
	100	2N1844A	2N683		2N3650	2N3655	S8612A	S8613A	S8622A	S8623A	
	150	2N1845A	2N684								
	200	2N1846A	2N685		2N3651	2N3656	S7310B	S8612B	S8613B	S8622B	S8623B
	250	2N1847A	2N686								
	300	2N1848A	2N687		2N3652	2N3657	S7310C				
	400	2N1849A	2N688		2N3653	2N3658	S7310D	S8612D	S8613D	S8622D	S8623D
	500	2N1850A	2N689				S7310E				
	600		2N690	S6493M	S7410M	S7412M	S7310M	S8612M	S8613M	S8622M	S8623M
I _{GT} (mA)	45	25	80	180	180	80	200	200	200	200	
V _{GT} (V)	3.5	3	2	3	2	3	3	3	3	3	

*FTO - Fast Turn-Off

*ASCR (Asymmetrical Silicon Controlled Rectifiers)

RCA SCR's	Overmold Stud		Overmold Isolated Stud		
I _T (RMS)	100A		100A		
I _{TSM} (60 Hz)	1000A		1000A		
V _{DROM}	15				
V _{RROM} (V)	25				
	30				
	50				
	100	S8610A	S8611A	S8620A	S8621A
	150				
	200	S8610B	S8611B	S8620B	S8621B
	250				
	300				
	400	S8610D	S8611D	S8620D	S8621D
	500				
	600	S8610M	S8611M	S8620M	S8621M
I _{GT} (mA)	200	200	200	200	
V _{GT} (V)	3	3	3	3	

ITR Product Matrix

For Horizontal-Deflection Circuits

RCA ITR's*	TO-220AB VERSAWATT			
	Trace	Commutating (Retrace)	Trace	Commutating (Retrace)
I _T (RMS)	8A	8A	8A	8A
I _{TSM} (60 Hz)	90A	90A	90A	90A
V _{DROM} (V)	300			
	400			
	450		S3902DF	
	500			
	550			
	600		S3901M	
	650	S3900MF	S3901MF	S3903MF
	700	S3900S	S3901S	
	750	S3900SF		
I _{GT} (mA)	30	45		
V _{GT} (V)	4	4		

*Integrated Thyristor/Rectifiers

GTO, Diac, and Rectifier Product Matrices

GTO Product Matrix

RCA GTO's*		TO-220AB VERSAWATT	
I_T (DC)		15A	15A
I_{TSM} (60 Hz)		85A	85A
V_{DRXM} (V)	100	G4000A	G4001A
	200	G4000B	G4001B
	400	G4000D	G4001D
t_{gq}		25 μ s	25 μ s

GTO – Gate-Turn-Off SCR

Diac Product Matrix

For Triggering Devices

RCA Diacs	DO-204AC/DO-15	
		D3202Y
I_{pk}	2A	2A
$\pm V_{(BO)}$	29 min. 35 max. V	25 min. 40 max. V
$ ^+V_{(BO)} - ^-V_{(BO)} $	± 3 max. V	± 3 max. V
$ \Delta V_{\pm} $	9 min. V	9 min. V

Rectifier Product Matrix

Standard Types

RCA Rectifiers	DO-203AA/ DO-4		DO-203AB/ DO-5		
	I_O	6A	12A	20A	40A
I_{FSM}	160A	240A	350A	800A	
V_{RRM} (V)	50	1N1341B	1N1199A	1N248C	1N1183A
	100	1N1342B	1N1200A	1N249C	1N1184A
	200	1N1344B	1N1202A	1N250C	1N1186A
	300	1N1345B	1N1203A	1N1195A	1N1187A
	400	1N1346B	1N1204A	1N1196A	1N1188A
	500	1N1347B	1N1205A	1N1197A	1N1189A
	600	1N1348B	1N1206A	1N1198A	1N1190A

Fast-Recovery Types

RCA Rectifier	DO-203AA/ DO-4				DO-203AB/ DO-5				
	I_O	6A	6A \diamond	12A	12A \diamond	20A	20A \diamond	30A	40A
I_{FSM}	75A	125A	150A	250A	225A	300A	300A	700A	
V_{RRM} (V)	50	1N3879	D2406F	1N3889	D2412F	1N3899	D2520F	1N3909	D2540F
	100	1N3880	D2406A	1N3890	D2412A	1N3900	D2520A	1N3910	D2540A
	200	1N3881	D2406B	1N3891	D2412B	1N3901	D2520B	1N3911	D2540B
	300	1N3882	D2406C	1N3892	D2412C	1N3902	D2520C	1N3912	
	400	1N3883	D2406D	1N3893	D2412D	1N3903	D2520D	1N3913	D2540D
	500								
	600		D2406M		D2412M		D2520M		D2540M
Reverse Recovery Time t_{rr}	Typ.	—	200 ns	—	200 ns	—	200 ns	—	200 ns
	Max.	200 ns	350 ns	200 ns	350 ns	200 ns	350 ns	200 ns	350 ns

\diamond Check availability in Europe, the Middle East, and Africa.

Power Devices Cross-Reference Guide

(Industry Type to Equivalent RCA Type)

This guide provides a quick reference to more than 2300 industry power devices (power transistors, silicon controlled rectifiers, and triacs) and their nearest RCA replacements. The nearest RCA device is determined on the basis of electrical similarity as well as package similarity.

POWER TRANSISTORS

Industry Type	Package	RCA Type	Package	Industry Type	Package	RCA Type	Package	Industry Type	Package	RCA Type	Package
2N656	TO-5	2N2102	TO-39	2N3022	TO-3	2N4902	TO-3	2N3464	TO-39	2N3053	TO-39
2N1132	TO-5	2N4037	TO-39	2N3023	TO-3	2N4902	TO-3	2N3597	TO-63	2N3266	TO-63
2N1132A	TO-5	2N4037	TO-39	2N3024	TO-3	2N4904	TO-3	2N3598	TO-63	2N3266	TO-63
2N1420	TO-5	2N1711	TO-39	2N3025	TO-3	2N4905	TO-3	2N3599	TO-63	2N3265	TO-63
2N1507	TO-5	2N1711	TO-39	2N3026	TO-3	2N4905	TO-3	2N3665	TO-39	2N1893	TO-39
2N1565	TO-5	40360	TO-39	2N3036	TO-5	2N5320	TO-39	2N3672	TO-5	2N699	TO-39
2N1565A	TO-5	40360	TO-39	2N3076	TO-36	2N6249	TO-3	2N3712	TO-39	2N3440	TO-39
2N1573	TO-5	40409	TO-39HR	2N3079	TO-36	2N6511	TO-3			BF257	TO-39
2N1574	TO-5	40409	TO-39HR	2N3080	TO-36	2N6670	TO-3	2N3713	TO-3	2N3715	TO-3
2N1613S	TO-5	2N1613	TO-39	2N3108	TO-39	2N2102	TO-39			2N3715	TO-3
2N1711S	TO-5	2N1711	TO-39	2N3109	TO-39	2N1711	TO-39	2N3714	TO-3	2N3716	TO-3
2N1714	TO-5	2N1480	TO-39	2N3110	TO-39	2N3053	TO-39			2N3716	TO-3
2N1889	TO-5	2N699	TO-39	2N3114	TO-39	BF257	TO-39			2N3716	TO-3
2N1893S	TO-5	2N1893	TO-39	2N3122	TO-5	2N5321	TO-39	2N3719	TO-39	2N5323	TO-39
2N1974	TO-5	40360	TO-39	2N3133	TO-39	40634	TO-39	2N3720	TO-39	2N5322	TO-39
2N1975	TO-5	40360	TO-39	2N3134	TO-39	2N4037	TO-39	2N3738	TO-66	2N3584	TO-66
2N1984	TO-5	40360	TO-39	2N3171	TO-3	2N6254	TO-3	2N3739	TO-66	2N3585	TO-66
2N1985	TO-5	40360	TO-39	2N3172	TO-3	2N6246	TO-3	2N3740	TO-66	2N5955	TO-66
2N1986	TO-5	2N3053	TO-39	2N3173	TO-3	2N6247	TO-3	2N3741	TO-66	2N5954	TO-66
2N1987	TO-5	2N697	TO-39	2N3174	TO-3	2N6248	TO-3	2N3742	TO-39	2N3439	TO-39
2N1990	TO-5	BF257	TO-39	2N3183	TO-3	2N6246	TO-3			BF259	TO-39
2N1990S	TO-5	BF257	TO-39	2N3184	TO-3	2N6246	TO-3	2N3743	TO-39	2N5416	TO-39
2N2034	TO-5	2N5784	TO-39	2N3185	TO-3	2N6247	TO-3			BFT19B	TO-39
2N2049	TO-5	2N1711	TO-39	2N3186	TO-3	2N6248	TO-3	2N3766	TO-66	2N3879	TO-66
2N2102S	TO-5	2N2102	TO-39	2N3195	TO-3	2N6246	TO-3			2N3673	TO-66
2N2192	TO-5	2N1711	TO-39	2N3196	TO-3	2N6246	TO-3	2N3767	TO-66	2N6372	TO-66
2N2193	TO-39	2N1613	TO-39	2N3197	TO-3	2N6247	TO-3	2N3774	TO-5	2N5783	TO-39
2N2194	TO-39	2N699	TO-39	2N3198	TO-3	2N6248	TO-3	2N3775	TO-5	2N5781	TO-39
2N2195	TO-39	2N697	TO-39	2N3202	TO-5	2N5783	TO-39	2N3778	TO-5	2N5783	TO-39
2N2195A	TO-39	2N697	TO-39	2N3203	TO-5	2N5781	TO-39	2N3779	TO-5	2N5781	TO-39
				2N3208	TO-5	2N5783	TO-39	2N3782	TO-5	2N5783	TO-39
2N2217	TO-39	2N697	TO-39	2N3224	TO-5	2N5415	TO-39	2N3788	TO-3	2N5840	TO-3
2N2218	TO-39	2N697	TO-39	2N3225	TO-5	2N5415	TO-39	2N3789	TO-3	2N3791	TO-3
2N2243	TO-39	2N1893	TO-39	2N3226	TO-3	2N6253	TO-3	2N3790	TO-3	2N3792	TO-3
2N2243A	TO-39	2N1893	TO-39	2N3233	TO-3	2N3442	TO-3				
2N2270S	TO-39	2N2270	TO-39	2N3234	TO-3	2N3055	TO-3	2N3795	TO-5	2N5415	TO-39
2N2297	TO-39	2N1613	TO-39			2N6262	TO-3	2N3863	TO-3	2N3055	TO-3
2N2297S	TO-39	2N1613	TO-39	2N3235	TO-3	2N3055	TO-3	2N3864	TO-3	2N3442	TO-3
2N2303	TO-39	40315	TO-39	2N3236	TO-3	2N6254	TO-3	2N3865	TO-3	2N6262	TO-3
2N2330	TO-39	40814	TO-39	2N3237	TO-3	2N5302	TO-3	2N3902	TO-3	2N6308	TO-3
2N2410	TO-39	2N3053	TO-39	2N3238	TO-3	2N5882	TO-3			BUX18C	TO-3
2N2537	TO-39	40635	TO-39	2N3239	TO-3	2N5882	TO-3	2N3945	TO-5	2N2102	TO-39
2N2538	TO-39	2N1711	TO-39	2N3240	TO-3	2N5882	TO-3			2N2270	TO-39
2N2800	TO-39	40406	TO-39	2N3244	TO-39	2N5323	TO-39	2N4000	TO-39	2N5320	TO-39
2N2801	TO-39	40815	TO-39	2N3245	TO-39	2N5323	TO-39	2N4002	TO-63	2N3265	TO-63
2N2846	TO-39	2N697	TO-39					2N4004	Radial	2N3263	Radial
2N2848	TO-39	2N697	TO-39	2N3292	TO-5	2N697	TO-39				
2N2863	TO-39	2N5321	TO-39	2N3300	TO-5	2N1711	TO-39	2N4030	TO-39	2N4036	TO-39
2N2864	TO-39	2N3053	TO-39	2N3418	TO-39	2N5320	TO-39	2N4054	TO-202	RCP113C	TO-202
2N2868	TO-39	2N3053	TO-39	2N3444	TO-39	2N5321	TO-39	2N4055	TO-202	RCP113B	TO-202
2N2951	TO-39	41502	TO-39	2N3445	TO-3	2N6471	TO-3	2N4056	TO-202	RCP113B	TO-202
2N2958	TO-39	2N697	TO-39					2N4057	TO-202	RCP113B	TO-202
2N2959	TO-39	2N1711	TO-39	2N3446	TO-3	2N6472	TO-3	2N4070	TO-3	2N6306	TO-3
2N3020	TO-39	2N1893	TO-39	2N3447	TO-3	2N6471	TO-3	2N4071	TO-3	2N6306	TO-3
				2N3448	TO-3	2N6472	TO-3				

Power Devices Cross-Reference Guide

(Industry Type to Equivalent RCA Type)

POWER TRANSISTORS (CONT'D)

Industry Type	RCA Package Type	Package	Industry Type	RCA Package Type	Package	Industry Type	RCA Package Type	Package			
2N4111	TO-3	2N4914	TO-3	2N5192	Case 77	BD241B	TO-220	2N5687	TO-39	40412	TO-39
2N4113	TO-3	2N4915	TO-3	2N5193	Case 77	BD242	TO-220	2N5732	TO-3	2N5671	TO-3
2N4130	TO-3	2N3055	TO-3	2N5194	Case 77	BD242A	TO-220	2N5733	TO-63	2N3265	TO-63
2N4210	TO-63	2N3266	TO-63	2N5195	Case 77	BD242B	TO-220	2N5734	TO-3	2N5671	TO-3
2N4211	TO-63	2N3265	TO-63	2N5241	TO-3	2N6513	TO-3	2N5737	TO-3	2N6246	TO-3
2N4231	TO-66	2N6374	TO-66			BUX18C	TO-3	2N5738	TO-3	2N6248	TO-3
2N4232	TO-66	2N6373	TO-66	2N5264	TO-3	2N6510	TO-3	2N5739	TO-3	2N5878	TO-3
2N4233	TO-66	2N6372	TO-66	2N5279	TO-5	2N3439	TO-39	2N5758	TO-3	2N3442	TO-3
2N4234	TO-39	2N5783	TO-39	2N5280	Flange	2N4036	TO-39FL			2N6262	TO-3
2N4235	TO-39	2N5782	TO-39	2N5281	TO-5	2N5415	TO-39	2N5759	TO-3	2N3442	TO-3
2N4236	TO-39	2N5781	TO-39	2N5282	TO-5	2N5416	TO-39			2N6262	TO-3
2N4237	TO-39	2N5786	TO-39	2N5294	TO-220	2N5294	TO-220	2N5760	TO-3	2N3442	TO-3
2N4238	TO-39	2N5785	TO-39	2N5296	TO-220	2N5298	TO-220			2N6262	TO-3
2N4239	TO-39	2N5784	TO-39	2N5298	TO-220	2N5298	TO-220	2N5861	TO-39	2N5321	TO-39
2N4387	TO-66	2N5956	TO-66	2N5305	TO-3	BDY29	TO-3	2N5864	TO-39	40634	TO-39
				2N5331	TO-63	2N3265	TO-63	2N5865	TO-39	40634	TO-39
2N4388	TO-66	2N5955	TO-66	2N5344	TO-66	2N6211	TO-66	2N5867	TO-3	2N6246	TO-3
2N4404	TO-39	2N1893	TO-39	2N5345	TO-66	2N6212	TO-66	2N5868	TO-3	2N6247	TO-3
2N4405	TO-39	2N2405	TO-39	2N5427	TO-66	2N6372	TO-66				
2N4438	TO-39	2N3439	TO-39	2N5429	TO-66	2N6465	TO-66	2N5929	TO-3	2N5671	TO-3
2N4890	TO-39	2N4037	TO-39	2N5466	TO-3	2N6671	TO-3	2N5930	TO-3	2N5672	TO-3
2N4898	TO-66	2N5956	TO-66	2N5467	TO-3	2N6671	TO-3	2N5932	TO-3	2N5671	TO-3
2N4899	TO-66	2N5955	TO-66	2N5539	TO-63	2N3265	TO-63	2N5933	TO-3	2N5672	TO-3
2N4900	TO-66	2N5954	TO-66	2N5560	TO-63	2N3265	TO-63	2N5935	TO-3	2N6032	Mod.
2N4907	TO-3	2N6246	TO-3								
2N4908	TO-3	2N6246	TO-3	2N5598	TO-66	2N5202	TO-66	2N5936	TO-3	2N6033	Mod.
2N4909	TO-3	2N6247	TO-3	2N5600	TO-66	2N6500	TO-66				
2N4910	TO-66	2N6260	TO-66	2N5602	TO-66	2N3879	TO-66	2N5966	TO-63	2N3265	TO-63
		2N6374	TO-66	2N5604	TO-66	2N6500	TO-66	2N5968	TO-63	2N3265	TO-63
2N4911	TO-66	2N3054	TO-66	2N5606	TO-66	2N3879	TO-66	2N5970	TO-3	2N6472	TO-3
		2N6373	TO-66	2N5608	TO-66	2N3879	TO-66	2N5971	TO-3	2N6472	TO-3
2N4912	TO-66	2N6261	TO-66	2N5610	TO-66	2N6500	TO-66	2N5972	TO-3	2N6472	TO-3
		2N6372	TO-66	2N5612	TO-66	2N6500	TO-66	2N5974	Case 90	2N6489	TO-220
				2N5614	TO-3	2N5039	TO-3	2N5975	Case 90	2N6490	TO-220
2N4918	Case 77	BD240	TO-220	2N5616	TO-3	2N5038	TO-3	2N5976	Case 90	2N6491	TO-220
2N4919	Case 77	BD240A	TO-220	2N5618	TO-3	2N5038	TO-3	2N5977	Case 90	2N6486	TO-220
2N4920	Case 77	BD240B	TO-220	2N5620	TO-3	2N6496	TO-3	2N5978	Case 90	2N6487	TO-220
				2N5622	TO-3	2N5039	TO-3	2N5979	Case 90	2N6488	TO-220
2N4921	Case 77	BD239	TO-220	2N5624	TO-3	2N5038	TO-3	2N5980	Case 90	2N6489	TO-220
2N4922	Case 77	BD239A	TO-220					2N5981	Case 90	2N6490	TO-220
2N4923	Case 77	BD239B	TO-220	2N5626	TO-3	2N5038	TO-3	2N5982	Case 90	2N6491	TO-220
2N4926	TO-39	2N3440	TO-39	2N5628	TO-3	2N6496	TO-3	2N5983	Case 90	2N6486	TO-220
		BF258	TO-39	2N5629	TO-3	2N4348	TO-3	2N5984	Case 90	2N6487	TO-220
2N4927	TO-39	2N3440	TO-39			RCA8638E	TO-3	2N5985	Case 90	2N6488	TO-220
		BF258	TO-39	2N5630	TO-3	2N4348	TO-3	2N5986	Case 90	2N6489	TO-220
2N4928	TO-39	BFT28	TO-39			RCA8638D	TO-3	2N5987	Case 90	2N6490	TO-220
2N4929	TO-39	BFT28A	TO-39	2N5631	TO-3	RCA3773	TO-3	2N5988	Case 90	2N6491	TO-220
2N4930	TO-39	2N5415	TO-39	2N5632	TO-3	RCA8638E	TO-3	2N5989	Case 90	2N6486	TO-220
		BFT28B	TO-39	2N5633	TO-3	RCA8638D	TO-3	2N5990	Case 90	2N6487	TO-220
2N4931	TO-39	2N5416	TO-39	2N5634	TO-3	MJ15003	TO-3	2N5991	Case 90	2N6488	TO-220
		BFT28C	TO-39			BDY37	TO-3	2N6029	TO-3	RCA9116E	TO-3
2N5050	TO-66	2N3584	TO-66	2N5655	Case 77	2N6175	TO-5P	2N6030	TO-3	RCA9116D	TO-3
2N5051	TO-66	2N3584	TO-66	2N5656	Case 77	2N6176	TO-5P	2N6031	TO-3	2N6609	TO-3
2N5052	TO-66	2N3584	TO-66	2N5657	Case 77	2N6177	TO-5P	2N6034	Case 77	2N6666	TO-220
2N5058	TO-39	2N3439	TO-39	2N5660	TO-66	2N6077	TO-66	2N6034	Case 77	2N6666	TO-220
		BF259	TO-39	2N5661	TO-66	2N6079	TO-66			BDX34	TO-220
2N5059	TO-39	2N3440	TO-39	2N5664	TO-66	2N6077	TO-66	2N6035	Case 77	RCA125	TO-220
		BF258	TO-39	2N5665	TO-66	2N6079	TO-66			BDX34A	TO-220
2N5091	TO-5	2N5416	TO-39	2N5672	TO-63	2N3265	TO-63	2N6036	Case 77	RCA126	TO-220
2N5092	TO-5	2N3439	TO-39	2N5678	TO-63	2N3265	TO-63			BDX34B	TO-220
2N5110	TO-5	2N5783	TO-39	2N5685	TO-3	2N5578	Mod.	2N6037	Case 77	2N6386	TO-220
2N5157	TO-3	2N5840	TO-3							BDX33	TO-220
2N5190	Case 77	BD241	TO-220					2N6038	Case 77	RCA120	TO-220
2N5191	Case 77	BD241A	TO-220	2N5686	TO-3	2N5578	Mod.			BDX33A	TO-220

Power Devices Cross-Reference Guide

(Industry Type to Equivalent RCA Type)

POWER TRANSISTORS (CONT'D)

Industry Type	Package	RCA Type	Package	Industry Type	Package	RCA Type	Package	Industry Type	Package	RCA Type	Package
2N6039	Case 77	RCA121	TO-220	2N6300	TO-66	2N6534	TO-66	2SB531	TO-3	2N6247	TO-3
		BDX33B	TO-220	2N6301	TO-66	2N6534	TO-66	2SB558	TO-3	2N6248	TO-3
2N6040	Case 199	RCA125	TO-220	2N6302	TO-3	RCA3773	TO-3	2SB595	TO-220	2N6475	TO-220
		BDX34A	TO-220	2N6312	TO-66	2N6308	TO-3	2SB596	TO-220	2N6107	TO-220
2N6041	Case 199	RCA126	TO-220			2N5956	TO-66	2SC481	TO-39	2N699	TO-39
		BDX34B	TO-220	2N6313	TO-66	2N5955	TO-66	2SC482	TO-39	2N1613	TO-39
2N6042	Case 199	RCA126	TO-220	2N6314	TO-66	2N5954	TO-66	2SC485	TO-39	2N1893	TO-39
		BDX34C	TO-220	2N6338	TO-3	2N5672	TO-3	2SC504	TO-39	2N1711	TO-39
2N6043	Case 199	RCA120	TO-220	2N6339	TO-3	2N5672	TO-3	2SC512	TO-39	2N699	TO-39
		BDX33A	TO-220	2N6359	TO-3	2N4348	TO-3	2SC558	TO-3	BUX17A	TO-3
2N6044	Case 199	RCA121	TO-220	2N6360	TO-3	2N4348	TO-3	2SC560	TO-39	2N2405	TO-39
		BDX33B	TO-220	2N6406	Case 77	RCP700B	TO-202	2SC779	TO-66	2N3584	TO-66
2N6045	Case 199	2N6531	TO-220	2N6407	Case 77	RCP700C	TO-202	2SC782	TO-66	2N3585	TO-66
		BDX33C	TO-220	2N6408	Case 77	RCP701B	TO-202	2SC782A	TO-66	2N3585	TO-66
2N6046	TO-63	2N3266	TO-63	2N6409	Case 77	RCP701C	TO-202	2SC783	TO-66	2N3583	TO-66
2N6047	TO-63	2N3265	TO-63	2N6412	Case 77	RCP701A	TO-202	2SC789	TO-220	2N6292	TO-220
2N6248	TO-63	2N3265	TO-63	2N6413	Case 77	RCP701B	TO-202	2SC790	TO-220	2N6290	TO-220
2N6049	TO-66	2N5955	TO-66	2N6414	Case 77	RCP700A	TO-202	2SC792	TO-3	BUX16B	TO-3
2N6050	TO-3	2N6649	TO-3	2N6415	Case 77	RCP700B	TO-202	2SC1173	TO-220	2N6288	TO-220
2N6051	TO-3	2N6650	TO-3	2N6415	Case 77	RCP701C	TO-202	2SC1195	TO-3	BUX16	TO-3
2N6053	TO-3	2N6649	TO-3	2N6417	Case 77	RCP701D	TO-202	2SC1448A	TO-220	TA8863	TO-220
2N6054	TO-3	2N6650	TO-3	2N6418	Case 77	RCP700C	TO-202	2SC1576	TO-3	BUX16	TO-3
2N6057	TO-3	2N6384	TO-3	2N6419	Case 77	RCP700D	TO-202	2SD102	TO-66	2N6261	TO-66
2N6058	TO-3	2N6385	TO-3	2N6420	TO-66	2N6211	TO-66	2SD129	TO-66	2N6372	TO-66
2N6062	TO-63	2N3265	TO-63	2N6421	TO-66	2N6212	TO-66	2SD130	TO-66	2N3054	TO-66
2N6063	TO-63	2N3265	TO-63	2N6422	TO-66	2N6212	TO-66	2SD234	TO-220	RCA3054	TO-220
2N6121	TO-220	2N6290	TO-220	2N6423	TO-66	2N6212	TO-66	2SD235	TO-220	RCA3054	TO-220
2N6122	TO-220	2N6292	TO-220	2N6424	TO-66	2N6211	TO-66	2SD369	TO-3	2N3055	TO-3
2N6123	TO-220	RCA31B	TO-220	2N6425	TO-66	2N6212	TO-66	2SD371	TO-3	2N6254	TO-3
		BD241B	TO-220	2N6436	TO-3	2N5671	TO-3	2SD404C	TO-220	2N6288	TO-220
2N6124	TO-220	2N6109	TO-220	2N6437	TO-3	2N5672	TO-3	2SD424	TO-3	2N6262	TO-3
2N6125	TO-220	2N6107	TO-220	2N6438	TO-3	2N5672	TO-3	2SD425	TO-3	2N3442	TO-3
2N6126	TO-220	RCA32B	TO-220	2N6461	TO-39	2N3439	TO-39	2SD427	TO-3	2N4347	TO-3
		BD242B	TO-220	2N6542	TO-3	2N6670	TO-3	2SD428	TO-3	2N4348	TO-3
2N6129	TO-220	2N6290	TO-220	2N6543	TO-3	2N6671	TO-3	2SD523	TO-3	2N6384	TO-3
2N6130	TO-220	2N6292	TO-220	2N6544	TO-3	2N6670	TO-3	2SD524	TO-3	2N6385	TO-3
2N6131	TO-220	2N6292	TO-220	2N6545	TO-3	2N6671	TO-3	2SD526	TO-220	2N6292	TO-220
2N6132	TO-220	2N6109	TO-220	2N6551	TO-202	RCP701B	TO-202	2SD552	TO-3	BUX17A	TO-3
2N6133	TO-220	2N6107	TO-220	2N6552	TO-202	RCP701C	TO-202	73T2	TO-39FL	40392	TO-39FL
2N6134	TO-220	RCA32B	TO-220	2N6553	TO-202	RCP701D	TO-202	74T2	TO-39FL	40628	TO-39FL
		BD242B	TO-220	2N6554	TO-202	RCP700B	TO-202	100T2	TO-3	2N4347	TO-3
2N6226	TO-3	2N6248	TO-3	2N6555	TO-202	RCP700C	TO-202	104T2	TO-3	2N6253	TO-3
2N6229	TO-3	2N6248	TO-3	2N6556	TO-202	RCP700D	TO-202	108T2	TO-3	2N5039	TO-3
2N6230	TO-3	RCA9116D	TO-3	2N6557	TO-202	RCP111B	TO-202	109T2	TO-3	2N6354	TO-3
2N6231	TO-3	MJ15004	TO-3			RCP113B	TO-202	182T2A	TO-3	BUX16	TO-3
2N6233	TO-66	2N3583	TO-66	2N6558	TO-202	RCP111C	TO-202	182T2B	TO-3	BUX16	TO-3
		2N6077	TO-66			RCP113C	TO-202	182T2C	TO-3	BUX16	TO-3
2N6234	TO-66	2N3584	TO-66	2N6559	TO-202	RCP111D	TO-202	184T2A	TO-3	BUX16	TO-3
		2N6077	TO-66			RCP113D	TO-202	183T2B	TO-3	BUX16	TO-3
2N6235	TO-66	2N3585	TO-66	2N6569	TO-3	2N3055	TO-3	183T2C	TO-3	BUX16	TO-3
		2N6079	TO-66	2SA489	TO-220	2N6107	TO-220	183T2A	TO-3	BUX16	TO-3
2N6248	TO-63	2N3265	TO-63	2SA490	TO-220	2N6109	TO-220	184T2B	TO-3	BUX16	TO-3
2N6270	TO-3	2N5671	TO-3	2SA503	TO-39	2N4314	TO-39	184T2C	TO-3	BUX16	TO-3
2N6271	TO-3	2N5672	TO-3	2SA504	TO-39	2N4037	TO-39	185T2A	TO-3	BUX16A	TO-3
2N6272	TO-63	2N3265	TO-63	2SA512	TO-39	2N4314	TO-39	185T2B	TO-3	BUX16A	TO-3
2N6273	TO-63	2N3265	TO-63	2SA560	TO-39	2N4314	TO-39	185T2C	TO-3	BUX16A	TO-3
2N6294	TO-66	2N6534	TO-66	2SA597	TO-39	2N4037	TO-39	40250	TO-66	2N3054	TO-66
2N6295	TO-66	2N6534	TO-66	2SA814	TO-220	2N6476	TO-220	40251	TO-3	2N3055	TO-3
2N6296	TO-66	RCA8350A	TO-3	2SA815	TO-220	2N6475	TO-220	40636	TO-3	2N3055	TO-3
2N6297	TO-66	RCA8350B	TO-3	2SB502A	TO-66	2N5954	TO-66	BC119	TO-39	2N697	TO-39
2N6298	TO-66	RCA8350A	TO-3	2SB503A	TO-66	2N5955	TO-66	BC120	TO-39	2N697	TO-39
2N6299	TO-66	RCA8350B	TO-3	2SB530	TO-3	2N6248	TO-3	BC139	TO-39	40406	TO-39

Power Devices Cross-Reference Guide (Industry Type to Equivalent RCA Type)

POWER TRANSISTORS (CONT'D)

Industry				Industry				Industry			
Type	Package	Type	Package	Type	Package	Type	Package	Type	Package	Type	Package
BC140	TO-39	2N5321	TO-39	BD205	Case 90	2N6486	TO-220	BD316	TO-3	2N6247	TO-3
BC141	TO-39	2N5320	TO-39	BD206	Case 90	2N6489	TO-220	BD317	TO-3	2N6472	TO-3
BC142	TO-39	40360	TO-39	BD207	Case 90	2N6487	TO-220	BD318	TO-3	2N6248	TO-3
BC143	TO-39	40595	TO-39	BD208	Case 90	2N6490	TO-220	BD375	TO-126	BD239	TO-220
BC144	TO-39	40594	TO-39	BD213-45	TO-3P	2N6486	TO-220	BD376	TO-126	BD240	TO-220
BC160	TO-39	2N5323	TO-39	BD213-60	TO-3P	2N6487	TO-220	BD377	TO-126	BD239A	TO-220
BC161	TO-39	2N5322	TO-39	BD213-80	TO-3P	2N6489	TO-220	BD378	TO-126	BD240A	TO-220
BC300	TO-39	2N1893	TO-39	BD214-45	TO-3P	2N6489	TO-220	BD379	TO-126	BD239B	TO-220
BC301	TO-39	2N699	TO-39	BD214-60	TO-3P	2N6490	TO-220	BD380	TO-126	BD240B	TO-220
BC302	TO-39	2N2270	TO-39	BD214-80	TO-3P	2N6491	TO-220	BD410	TO-126	RCP111D	TO-202
BC303	TO-39	2N4314	TO-39	BD215	TO-66	2N3584	TO-66	BD515	TO-202	RCP701A	TO-202
BC304	TO-39	2N4037	TO-39	BD216	TO-66	2N3585	TO-66	BD516	TO-202	RCP700A	TO-202
BC310	TO-39	2N1893	TO-39	BD244A	TO-220	BD244A	TO-220	BD517	TO-202	RCP701B	TO-202
BC311	TO-39	2N4314	TO-39	BD244B	TO-220	BD244B	TO-220	BD518	TO-202	RCP701C	TO-202
BC323	TO-39	2N5320	TO-39	BD244C	TO-220	BD244C	TO-220	BD519	TO-202	RCP701C	TO-202
BC324	TO-39	2N5320	TO-39	BD245	TO-3P	2N6486	TO-220	BD520	TO-202	RCP700C	TO-202
BC429	TO-39	2N2270	TO-39	BD245A	TO-3P	2N6487	TO-220	BD525	TO-202	RCP701B	TO-202
BC430	TO-39	2N2270	TO-39	BD245B	TO-3P	2N6488	TO-220	BD526	TO-202	RCP700B	TO-202
BC440	TO-39	2N5321	TO-39	BD246	TO-3P	2N6489	TO-220	BD527	TO-202	RCP701C	TO-202
BC441	TO-39	2N5320	TO-39	BD246A	TO-3P	2N6490	TO-220	BD528	TO-202	RCP700C	TO-202
BC460	TO-39	2N5323	TO-39	BD246B	TO-3P	2N6491	TO-220	BD529	TO-202	RCP701D	TO-202
BC461	TO-39	2N5322	TO-39	BD253	TO-3	BUX18B	TO-3	BD530	TO-202	RCP700D	TO-202
BCW44	TO-39	40360	TO-39	BD253A	TO-3	BUX18C	TO-3	BD530	TO-202	RCP700D	TO-202
BCW45	TO-39	40362	TO-39	BD253B	TO-3	BU126	TO-3	BD575	Case	BD241	TO-220
BCW77-16	TO-39	2N1711	TO-39	BD253C	TO-3	TA8764	TO-3	199			
BCW78-16	TO-39	2N1711	TO-39	BD260	TO-66	2N3584	TO-66	BD576	Case	BD242	TO-220
BCW79-16	TO-39	2N4037	TO-39	BD261	TO-66	2N3584	TO-66	199			
BCW80-16	TO-39	2N4037	TO-39	BD264	TO-220	RC A8203A	TO-220	BD577	Case	BD241A	TO-220
BCY40	TO-39	2N4037	TO-39	BD264A	TO-220	RC A8203B	TO-220	199			
BCY54	TO-39	2N4036	TO-39	BD264B	TO-220	BDX34C	TO-220	BD578	Case	BD242A	TO-220
BD115	TO-39	BF258	TO-39	BD265	TO-220	2N6387	TO-220	199			
BD116	TO-3	2N3055	TO-3	BD265A	TO-220	2N6388	TO-220	BD579	Case	BD241B	TO-220
BD141	TO-3	2N4347	TO-3	BD265B	TO-220	BDX33C	TO-220	199			
BD144	TO-3	BUX18C	TO-3	BD266	TO-220	BDX34A	TO-220	BD580	Case	BD242B	TO-220
BD148	TO-66	BDY71	TO-66	BD266A	TO-220	BDX34B	TO-220	199			
BD149	TO-66	BDY71	TO-66	BD266B	TO-220	BDX34C	TO-220	BD581	Case	BD242C	TO-220
BD160	TO-3	2N6510	TO-3	BD267	TO-220	BDX33A	TO-220	199			
BD162	TO-66	40250	TO-66	BD267A	TO-220	BDX33B	TO-220	BD582	Case	BD242C	TO-220
BD163	TO-66	2N6260	TO-66	BD267B	TO-220	BDX33C	TO-220	199			
BD185	TO-126	BD239	TO-220	BD268	TO-220	BDX34A	TO-220	BD585	Case	BD241	TO-220
BD186	TO-126	BD240	TO-220	BD268A	TO-220	BDX34B	TO-220	199			
BD187	TO-126	BD239	TO-220	BD269	TO-220	BDX33A	TO-220	BD586	Case	BD242	TO-220
BD188	TO-126	BD240	TO-220	BD269A	TO-220	BDX33B	TO-220	199			
BD189	TO-126	BD239A	TO-220	BD271	TO-220	BD241	TO-220	BD587	Case	BD241A	TO-220
BD190	TO-126	BD240A	TO-220	BD272	TO-220	BD242	TO-220	199			
BD191	TO-66	2N3054	TO-66	BD273	TO-220	BD241A	TO-220	BD588	Case	BD242A	TO-220
BD192	TO-66	2N6260	TO-66	BD274	TO-220	BD242A	TO-220	199			
BD195	Case 90	BD243	TO-220	BD275	TO-220	BD241B	TO-220	BD589	Case	BD241B	TO-220
BD196	Case 90	BD244	TO-220	BD276	TO-220	BD242B	TO-220	199			
BD197	Case 90	BD243A	TO-220	BD291	SOT-82	BD243	TO-220	BD590	Case	BD242B	TO-220
BD198	Case 90	BD244A	TO-220	BD292	SOT-82	BD244	TO-220	199			
BD199	Case 90	CD243B	TO-220	BD293	SOT-82	BD243A	TO-220	BD591	Case	BD241C	TO-220
BD200	Case 90	BD244B	TO-220	BD294	SOT-82	BD244A	TO-220	199			
BD201	Case	BD243	TO-220	BD301	TO-220	BD243	TO-220	BD592	Case	BD242C	TO-220
	199			BD302	TO-220	BD244	TO-220	199			
BD202	Case	BD244	TO-220	BD303	TO-220	BD243A	TO-220	BD595	Case	BD243	TO-220
	199			BD304	TO-220	BD244A	TO-220	199			
BD203	Case	BD243A	TO-220	BD311	TO-3	2N6471	TO-3	BD596	Case	BD244	TO-220
	199			BD312	TO-3	2N6246	TO-3	199			
BD204	Case	BD244A	TO-220	BD313	TO-3	2N6472	TO-3	BD597	Case	BD243A	TO-220
	199			BD314	TO-3	2N6247	TO-3	199			
				BD315	TO-3	2N6472	TO-3	BD598	Case	BD244A	TO-220
								199			

Power Devices Cross-Reference Guide

(Industry Type to Equivalent RCA Type)

POWER TRANSISTORS (CONT'D)

Industry Type	Package	RCA Type	Package	Industry Type	Package	RCA Type	Package	Industry Type	Package	RCA Type	Package
BD599	Case 199	BD243B	TO-220	BD701	Case 199	BDX33C	TO-220	BDY73	TO-3	2N3055	TO-3
BD600	Case 199	BD244B	TO-220	BD702	Case 199	BDX34C	TO-220	BDY74	TO-3	2N4347	TO-3
BD601	Case 199	BD243C	TO-220	BD705	TO-220	2N6486	TO-220	BDY76	TO-3	2N3772	TO-3
BD602	Case 199	BD244C	TO-220	BD706	TO-220	2N6489	TO-220	BDY77	TO-3	2N3773	TO-3
BD605	Case 199	2N6486	TO-220	BD707	TO-220	2N6487	TO-220	BDY78	TO-66	2N6373	TO-66
BD606	Case 199	2N6489	TO-220	BD708	TO-220	2N6490	TO-220	BDY79	TO-66	2N3583	TO-66
BD607	Case 199	2N6487	TO-220	BD709	TO-220	2N6488	TO-220	BDY80A	TO-220	2N5296	TO-220
BD608	Case 199	2N6490	TO-220	BD710	TO-220	2N6491	TO-220	BDY81A	TO-220	2N5298	TO-220
BD609	Case 199	2N6488	TO-220	BDX14	TO-66	2N3054	TO-66	BDY82A	TO-220	2N6111	TO-220
BD610	Case 199	2N6491	TO-220	BDX16	TO-66	BUX66	TO-66	BDY83A	TO-220	2N6109	TO-220
BD633	TO-220	40979	TO-220	BDX27	TO-66	2N3879	TO-66	BDY91	TO-3	2N5038	TO-3
BD634	TO-220	40980	TO-220	BDX28	TO-66	2N3879	TO-66	BDY92	TO-3	2N5039	TO-3
BD635	TO-220	40871	TO-220	BDX30	TO-66	2N6500	TO-66	BDY93	TO-3	BU126	TO-3
BD636	TO-220	40872	TO-220	BDX33	TO-220	BDX33	TO-220	BDY94	TO-3	BU126	TO-3
BD637	TO-220	40871	TO-220	BDX33A	TO-220	BDX33A	TO-220	BDY96	TO-3	2N6513	TO-3
BD638	TO-220	40872	TO-220	BDX33B	TO-220	BDX33B	TO-220	BDY97	TO-3	2N6512	TO-3
BD643	TO-220	BDX33	TO-220	BDX33C	TO-220	BDX33C	TO-220	BDY98	TO-3	2N6511	TO-3
BD644	TO-220	BDX34	TO-220	BDX54	TO-220	BDX34	TO-220	BDY99	TO-3	2N6511	TO-3
BD645	TO-220	BDX33A	TO-220	BDX54A	TO-220	BDX34A	TO-220	BF111	TO-39	2N3440	TO-39
BD646	TO-220	BDX34A	TO-220	BDX54B	TO-220	BDX34B	TO-220	NF137	TO-5	BF257	TO-39
BD647	TO-220	BDX33B	TO-220	BDX54C	TO-220	BDX34C	TO-220	BF157	TO-39	BF257	TO-39
BD648	TO-220	BDX34B	TO-220	BDX60	TO-3	2N6254	TO-3	BF174	TO-39	BF257	TO-39
BD661	TO-220	2N6486	TO-220	BDX61	TO-3	2N3055	TO-3	BF177	TO-39	40360	TO-39
BD662	TO-220	2N6489	TO-220	BDX62	TO-3	RCA8350A	TO-3	BF178	TO-39	40412	TO-39
BD663	TO-220	2N6486	TO-220	BDX62A	TO-3	RCA8350B	TO-3	BF179	TO-39	BF257	TO-39
BD663B	TO-220	2N6486	TO-220	BDX63	TO-3	2N6384	TO-3	BF179B	TO-39	BF258	TO-39
BD664	TO-220	2N6489	TO-220	BDX63A	TO-3	2N6385	TO-3	BF179C	TO-39	BF258	TO-39
BD665	Case 199	BDX33	TO-220	BDX64	TO-3	BDX84A	TO-3	BF305	TO-39	BF257	TO-39
BD695A	Case 199	BDX33	TO-220	BDX64A	TO-3	BDX84B	TO-3	BF322	TO-39	40317	TO-39
BD696	Case 199	BDX34	TO-220	BDX64B	TO-3	BDX84C	TO-3	BF323	TO-39	40319	TO-39
BD696A	Case 199	BDX34	TO-220	BDX65	TO-3	BDX83A	TO-3	BF336	TO-39	BF258	TO-39
BD697	Case 199	BDX33A	TO-220	BDX65A	TO-3	BDX83B	TO-3	BF337	TO-39	BF258	TO-39
BD697A	Case 199	BDX33A	TO-220	BDX65B	TO-3	BDX83C	TO-3	BF338	TO-39	BF258	TO-39
BD698	Case 199	BDX34A	TO-220	BDX77	TO-220	BD243B	TO-220	BF355	TO-39	2N3440	TO-39
BD698A	Case 199	BDX34A	TO-220	BDX78	TO-220	BD244B	TO-220	BF380	TO-202	RCP113A	TO-202
BD699	Case 199	BDX33B	TO-220	BDY10	TO-3	2N6253	TO-3	BF381	TO-202	RCP113B	TO-202
BD699A	Case 199	BDX33B	TO-220	BDY12	TO-3	BUX16	TO-3	BF382	TO-202	RCP113C	TO-202
BD700	Case 199	BDX34B	TO-220	BDY13	TO-3	BUX16	TO-3	BF390	TO-39	BF259	TO-39
BD700A	Case 199	BDX34B	TO-220	BDY15	TO-3	BUX16	TO-3	BFR19	TO-39	2N1613	TO-39
				BDY17	TO-3	BUX16	TO-3	BFR20	TO-39	2N1711	TO-39
				BDY20	TO-3	BUX16	TO-3	BFR21	TO-39	2N1893	TO-39
				BDY25A	TO-3	BUX16	TO-3	BFR22	TO-39	2N2102	TO-39
				BDY25B	TO-3	BUX16	TO-3	BFR23	TO-39	2N4036	TO-39
				BDY25C	TO-3	BUX16	TO-3	BFR24	TO-39	2N4037	TO-39
				BDY26A	TO-3	BUX16	TO-3	BFR56	TO-39	2N5321	TO-39
				BDY26B	TO-3	BUX16	TO-3	BFR57	TO-39	BF257	TO-39
				BDY26C	TO-3	BUX16	TO-3	BFR58	TO-39	BF258	TO-39
				BDY27A	TO-3	BUX16	TO-3	BFR59	TO-39	BF259	TO-39
				BDY27B	TO-3	BUX16	TO-3	BFR77	TO-39	2N1893	TO-39
				BDY27C	TO-3	BUX16	TO-3	BFR78	TO-39	2N2405	TO-39
				BDY28A	TO-3	BUX16A	TO-3	BFS90	TO-39	40987	TO-39
				BDY28B	TO-3	BUX16A	TO-3	BFS90A	TO-39	40987	TO-39
				BDY28C	TO-3	BUX16A	TO-3	BFS91	TO-39	40999	TO-39
				BDY38	TO-3	2N6253	TO-3	BFS91A	TO-39	40999	TO-39
				BDY39	TO-3	2N3055	TO-3	BFS92	TO-39	2N4036	TO-39
				BDY55	TO-3	2N5039	TO-3	BFS93	TO-39	2N4314	TO-39
				BDY56	TO-3	2N5038	TO-3	BFS94	TO-39	2N4037	TO-39
				BDY57	TO-3	41012	TO-3	BFS95	TO-39	2N4037	TO-39
				BDY58	TO-3	41013	TO-3	BFT32	TO-39	40635	TO-39

Power Devices Cross-Reference Guide

(Industry Type to Equivalent RCA Type)

POWER TRANSISTORS (CONT'D)

Industry Type	Package	RCA Type	Package	Industry Type	Package	RCA Type	Package	Industry Type	Package	RCA Type	Package
BFT33	TO-39	40409	TO-39HR	BSS45	TO-39	2N5320	TO-39	BUY39	TO-3	2N5038	TO-3
BFT34	TO-39	2N2405	TO-39	BSS46	TO-39	2N5322	TO-39	BUY40	TO-3	2N6354	TO-3
BFT35	TO-39	2N4314	TO-39	BSS48	TO-39	2N3440	TO-39	BUY41	TO-3	BUX17A	TO-3
BFT36	TO-39	40410	TO-39HR	BSS49	TO-39	2N3439	TO-39	BUY42	TO-3	BUX17B	TO-3
BFT39	TO-39	40409	TO-39HR	BSV15	TO-39	2N4037	TO-39	BUY43	TO-3	BUX17C	TO-3
BFT40	TO-39	40628	TO-39HR	BSV15-6	TO-39	2N4037	TO-39	BUY44	TO-3	BUX18C	TO-3
BFT41	TO-39	40628	TO-39HR	BSV15-10	TO-39	2N4037	TO-39	BUY84	TO-220	TA8863A	TO-220
BFT44	TO-39	BF259	TO-39	BSV16	TO-39	2N4314	TO-39	BUY35	TO-3	2N6511	TO-3
BFT45	TO-39	BF258	TO-39	BSV16-6	TO-39	2N4314	TO-39	BUY43	TO-66	BDY71	TO-66
BFT60	TO-39	2N4037	TO-39	BSV16-10	TO-39	2N4314	TO-39	BUY46	TO-66	2N3054	TO-66
BFT61	TO-39	2N4037	TO-39	BSV17	TO-39	2N5322	TO-39	BUY55	TO-3	2N5239	TO-3
BFT62	TO-39	40815	TO-39	BSV69	TO-39	2N5321	TO-39	BUY56	TO-3	2N5239	TO-3
BFT80	TO-39	40815	TO-39	BSV77	TO-39	2N5321	TO-39	BUY66	TO-3	BU126	TO-3
BFW24	TO-39	2N2102	TO-39	BSV84	TO-39	2N1893	TO-39	BUY67	TO-3	BU126	TO-3
BFW25	TO-39	2N1711	TO-39	BSW23	TO-39	2N4037	TO-39	BUY69B	TO-3	BU126	TO-3
BFW26	TO-39	2N697	TO-39	BSW39	TO-39	2N1893	TO-39	BUY69C	TO-3	BU126	TO-3
BFW33	TO-39	2N1893	TO-39	BSX22	TO-39	2N5321	TO-39	BUY70B	TO-3	BU126	TO-3
BFW44	TO-39	BFT19	TO-39	BSX23	TO-39	2N5320	TO-39	BUY70C	TO-3	BU126	TO-3
BFW45	TO-39	BF257	TO-39	BSX40	TO-39	2N4037	TO-39	BUY72	TO-3	2N5239	TO-3
BFX17	TO-39	2N3053	TO-39	BSX45	TO-39	2N3053	TO-39	BUY74	TO-3	BUX18A	TO-3
BFX29	TO-39	2N4036	TO-39	BSX46	TO-39	2N2102	TO-39	BUY75	TO-3	BUX18C	TO-3
BFX30	TO-39	2N4036	TO-39	BSX47	TO-39	2N1893	TO-39	BUY76	TO-3	BU126	TO-3
BFX39	TO-39	2N4036	TO-39	BSX59	TO-39	2N5321	TO-39	BUY77	TO-3	BUX18A	TO-3
BFX68	TO-39	2N1711	TO-39	BSX60	TO-39	2N5321	TO-39	BUY78	TO-3	BUX18C	TO-3
BFX68A	TO-39	2N1711	TO-39	BSX61	TO-39	2N5321	TO-39	BUY79	TO-3	BUX126	TO-3
BFX69	TO-39	2N697	TO-39	BSX72	TO-39	2N3053	TO-39	D40D1	TO-202	RCP707	TO-202
BFX69A	TO-39	2N1613	TO-39	BSX95	TO-39	2N1613	TO-39	D40D2	TO-202	RCP707	TO-202
BFX74	TO-39	2N4037	TO-39	BSX96	TO-39	2N1711	TO-39	D40D3	TO-202	RCP707	TO-202
BFX74A	TO-39	2N4314	TO-39	BSY25	TO-39	2N697	TO-39	D40D4	TO-202	RCP707	TO-202
BFX85	TO-39	2N2405	TO-39	BSY44	TO-39	2N699	TO-39	D40D5	TO-202	RCP707	TO-202
BFX86	TO-39	2N1711	TO-39	BSY45	TO-39	2N1893	TO-39	D40D6	TO-202	RCP701B	TO-202
BFX87	TO-39	2N4036	TO-39	BSY46	TO-39	2N699	TO-39	D40D7	TO-202	RCP701B	TO-202
BFX88	TO-39	2N4037	TO-39	BSY51	TO-39	2N697	TO-39	D40D8	TO-202	RCP701B	TO-202
BFX91	TO-39	BFT28B	TO-39	BSY52	TO-39	2N1711	TO-39	D40D10	TO-202	RCP701C	TO-202
BFX98	TO-39	BF257	TO-39	BSY53	TO-39	2N697	TO-39	D40D11	TO-202	RCP701C	TO-202
BFY10	TO-39	40814	TO-39	BSY54	TO-39	2N1711	TO-39	D40D13	TO-202	RCP701C	TO-202
BFY11	TO-39	40814	TO-39	BSY55	TO-39	2N1893	TO-39	D40E1	TO-202	RCP705	TO-202
BFY17	TO-39	40317	TO-39	BSY68	TO-39	2N2405	TO-39	D40E5	TO-202	RCP701B	TO-202
BFY33	TO-39	2N697	TO-39	BSY71	TO-39	2N1711	TO-39	D40E7	TO-202	RCP701C	TO-202
BFY34	TO-39	2N697	TO-39	BSY81	TO-39	2N697	TO-39	D40N1	TO-202	RCP113B	TO-202
BFY40	TO-39	40320	TO-39	BSY82	TO-39	2N1711	TO-39	D40N2	TO-202	RCP111B	TO-202
BFY43	TO-39	BF257	TO-39	BSY83	TO-39	2N697	TO-39	D40N3	TO-202	RCP113C	TO-202
BFY44	TO-39	2N2102	TO-39	BSY84	TO-39	2N1711	TO-39	D40N4	TO-202	RCP111C	TO-202
BFY45	TO-39	40408	TO-39	BSY85	TO-39	2N1893	TO-39	D40N5	TO-202	RCP111C	TO-202
BFY46	TO-39	2N1711	TO-39	BSY87	TO-39	2N2102	TO-39	D40P1	TO-202	2N6175	TO-5P
BFY50	TO-39	2N697	TO-39	BSY91	TO-39	2N697	TO-39	D40P3	TO-202	2N6175	TO-5P
BFY51	TO-39	2N697	TO-39	BSY92	TO-39	2N1711	TO-39	D40P5	TO-202	2N6175	TO-5P
BFY52	TO-39	2N3053	TO-39	BU102	TO-3	BUX18B	TO-3	D41D1	TO-202	RCP706	TO-202
BFY55	TO-39	2N697	TO-39	BU111	TO-3	2N6512	TO-3	D41D2	TO-202	RCP706B	TO-202
BFY56	TO-39	2N699	TO-39	BU114	TO-3	2N6510	TO-3	D41D4	TO-202	RCP706B	TO-202
BFY57	TO-39	BF257	TO-39	BU121	TO-3	BUX18	TO-3	D41D5	TO-202	RCP700B	TO-202
BFY67	TO-39	2N3053	TO-39	BU129	TO-3	BUX18C	TO-3	D41D6	TO-202	RCP700B	TO-202
BFY67A	TO-39	2N1613	TO-39	BU134	TO-3	BU126	TO-3	D41D7	TO-202	RCP700B	TO-202
BFY68	TO-39	2N1711	TO-39	BU135	TO-3	2N6510	TO-3	D41D8	TO-202	RCP700B	TO-202
BFY70	TO-39	2N3053	TO-39	BU136	TO-3	2N6510	TO-3	D41D10	TO-202	RCP700C	TO-202
BFY94	TO-39	40594	TO-39	BU310	TO-3	BUX17	TO-3	D41D11	TO-202	RCP700C	TO-202
BSS15	TO-39	2N5320	TO-39	BU311	TO-3	BUX17	TO-3	D41D13	TO-202	RCP700C	TO-202
BSS16	TO-39	2N5321	TO-39	BU312	TO-3	BUX17	TO-3	D41E1	TO-202	RCP704	TO-202
BSS17	TO-39	2N5322	TO-39	BU409	TO-220	TA8863J	TO-220	D41E5	TO-202	RCP700B	TO-202
BSS18	TO-39	2N5323	TO-39	BUX26	TO-3	2N6510	TO-3				
BSS30	TO-39	2N2102	TO-39	BUX27	TO-3	BUX18C	TO-3				
BSS32	TO-39	2N2405	TO-39								

Power Devices Cross-Reference Guide

(Industry Type to Equivalent RCA Type)

POWER TRANSISTORS (CONT'D)

Industry Type	Package	RCA Type	Package	Industry Type	Package	RCA Type	Package	Industry Type	Package	RCA Type	Package
D41E7	TO-202	RCP700C	TO-202	D44C9	TO-220	2N6292	TO-220	DTS423	TO-3	RCA423	TO-3
D42C1	TO-202	2N6288	TO-220			BD239A	TO-220	DTS431	TO-3	RCA431	TO-3
		RCP707	TO-202	D44C10	TO-220	2N6292	TO-220	ESM113	TO-3	2N6384	TO-3
D42C2	TO-202	2N6288	TO-220			BD239B	TO-220	ESM114	TO-3	2N6385	TO-3
		RCP705	TO-202	D44C11	TO-220	2N6292	TO-220	ESM159	TO-3	RCA8350A	TO-3
D42C3	TO-202	2N6288	TO-220			BD239B	TO-220	ESM160	TO-3	RCA8350B	TO-3
		RCP705	TO-202	D44C12	TO-220	BD239B	TO-220	ESM213	TO-220	2N6387	TO-220
D42C4	TO-202	2N6290	TO-220	D44E1	TO-220	2N6386	TO-220	ESM214	TO-220	2N6388	TO-220
		RCP703A	TO-202	D44E2	TO-220	2N6387	TO-220	ESM217	TO-220	2N6387	TO-220
D42C5	TO-202	2N6290	TO-220	D44E3	TO-220	2N6388	TO-220	ESM218	TO-220	2N6388	TO-220
		RCP701A	TO-202	D44H1	TO-220	2N6288	TO-220	ESM259	TO-220	RCA8203A	TO-220
D42C6	TO-202	2N6290	TO-220	D44H2	TO-220	2N6288	TO-220	ESM260	TO-220	RCA8203B	TO-220
		RCP701A	TO-202	D44H4	TO-220	2N6290	TO-220	ESM261	TO-220	RCA8203A	TO-220
D42C7	TO-202	2N6292	TO-220	D44H5	TO-220	2N6290	TO-220	ESM262	TO-220	RCA8203B	TO-220
		RCP703B	TO-202	D44H7	TO-220	2N6292	TO-220	FT410	TO-3	RCA410	TO-3
D42C8	TO-202	2N6292	TO-220	D44H8	TO-220	2N6292	TO-220	FT411	TO-3	RCA411	TO-3
		RCP701B	TO-202	D44H10	TO-220	2N6292	TO-220	FT413	TO-3	RCA413	TO-3
D42C9	TO-202	2N6292	TO-220	D44H11	TO-220	2N6292	TO-220	FT423	TO-3	RCA423	TO-3
		RCP701B	TO-202	D44R1	TO-220	TA8863B	TO-220	FT431	TO-3	RCA431	TO-3
D42C10	TO-202	2N6292	TO-220	D44R2	TO-220	TA8863B	TO-220	MJ400	TO-66	2N3585	TO-66
		RCP703C	TO-202	D44R3	TO-220	TA8863B	TO-220	MJ410	TO-3	RCA410	TO-3
D42C11	TO-202	2N6292	TO-220	D44R4	TO-220	TA8863B	TO-220	MJ411	TO-3	RCA411	TO-3
		RCP701C	TO-202	D44R5	TO-220	TA8863F	TO-220	MJ413	TO-3	RCA413	TO-3
D42C12	TO-202	RCP701C	TO-202	D44R6	TO-220	TA8863F	TO-220	MJ420	TO-39	BF258	TO-39
D43C1	TO-202	2N6111	TO-220	D45C1	TO-220	2N6111	TO-220	MJ423	TO-3	RCA423	TO-3
		RCP706	TO-202			BD240	TO-220	MJ424	TO-3	BUX16C	TO-3
D43C2	TO-202	2N6111	TO-220	D45C2	TO-220	2N6111	TO-220	MJ425	TO-3	BUX18C	TO-3
		RCP704	TO-202			BD240	TO-220	MJ431	TO-3	RCA431	TO-3
D43C3	TO-202	2N6111	TO-220	D45C3	TO-220	2N6111	TO-220	MJ450	TO-3	2N6246	TO-3
		RCP704	TO-202			BD240	TO-220			2N6469	TO-3
D43C4	TO-202	2N6109	TO-220	D45C4	TO-220	2N6109	TO-220	MJ480	TO-3	2N6470	TO-3
		RCP702A	TO-202			BD240	TO-220	MJ481	TO-3	2N6471	TO-3
D43C5	TO-202	2N6109	TO-220	D45C5	TO-220	2N6109	TO-220	MJ490	TO-3	2N6246	TO-3
		RCP700A	TO-202			BD240	TO-220			2N6469	TO-3
D43C6	TO-202	2N6109	TO-220	D45C6	TO-220	2N6109	TO-220	MJ491	TO-3	2N6246	TO-3
		RCP700A	TO-202			BD240	TO-220	MJ802	TO-3	RCS258	TO-3
D43C7	TO-202	2N6107	TO-220	D45C7	TO-220	2N6107	TO-220	MJ900	TO-3	RCA8350A	TO-3
		RCP702B	TO-202			BD240A	TO-220	MJ901	TO-3	RCA8350B	TO-3
D43C8	TO-202	2N6107	TO-220	D45C8	TO-220	2N6107	TO-220	MJ920	TO-3	RCA8350A	TO-3
		RCP700B	TO-202			BD240A	TO-220	MJ921	TO-3	RCA8350B	TO-3
D43C9	TO-202	2N6107	TO-220	D45C9	TO-220	2N6107	TO-220	MJ1000	TO-3	RCA1000	TO-3
		RCP700B	TO-202			BD240A	TO-220	MJ1001	TO-3	RCA1001	TO-3
D43C10	TO-202	2N6107	TO-220	D45C10	TO-220	2N6107	TO-220	MJ1200	TO-3	2N6384	TO-3
		RCP700B	TO-202			BD240B	TO-220	MJ1201	TO-3	2N6385	TO-3
D43C11	TO-202	2N6107	TO-220	D45C11	TO-220	2N6107	TO-220	MJ1800	TO-3	2N5838	TO-3
		RCP700C	TO-202			BD240B	TO-220			BUX16C	TO-3
D43C12	TO-202	RCP700C	TO-202	D45C12	TO-220	BD240B	TO-220	MJ2249	TO-66	2N3879	TO-66
D44C1	TO-220	2N6288	TO-220	D45E1	TO-220	2N6666	TO-220	MJ2250	TO-66	2N3879	TO-66
		BD239	TO-220	D45E2	TO-220	2N6667	TO-220	MJ2251	TO-66	2N3584	TO-66
D44C2	TO-220	2N6288	TO-220	D45E3	TO-220	2N6668	TO-220			BUX67B	TO-66
		BD239	TO-220	D45H1	TO-220	2N6111	TO-220	MJ2252	TO-66	2N3585	TO-66
D44C3	TO-220	2N6288	TO-220	D45H2	TO-220	2N6111	TO-220			BUX67C	TO-66
		BD239	TO-220	D45H4	TO-220	2N6109	TO-220	MJ2253	TO-66	2N5955	TO-66
D44C4	TO-220	2N6290	TO-220	D45H5	TO-220	2N6109	TO-220	MJ2254	TO-66	2N5954	TO-66
		BD239	TO-220	D45H7	TO-220	2N6107	TO-220	MJ2267	TO-3	2N6246	TO-3
D44C5	TO-220	2N6290	TO-220	D45H8	TO-220	2N6107	TO-220			2N6469	TO-3
		BD239	TO-220					MJ2268	TO-3	2N6246	TO-3
D44C6	TO-220	2N6290	TO-220	D45H10	TO-220	2N6107	TO-220	MJ2500	TO-3	2N6649	TO-204MA*
		BD239	TO-220	D45H11	TO-220	2N6107	TO-220			RCA8350A	TO-3
D44C7	TO-220	2N6292	TO-220	DTS410	TO-3	RCA410	TO-3	MJ2501	TO-3	2N6650	TO-204MA*
		BD239A	TO-220	DTS411	TO-3	RCA411	TO-3			RCA8350B	TO-3
D44C8	TO-220	2N6292	TO-220	DTS413	TO-3	RCA413	TO-3	MJ2801	TO-3	2N6371	TO-3
		BD239A	TO-220								

* JEDEC TO-204MA was formerly designated JEDEC TO-3.

Power Devices Cross-Reference Guide (Industry Type to Equivalent RCA Type)

POWER TRANSISTORS (CONT'D)

Industry Type	Package	RCA Type	Package	Industry Type	Package	RCA Type	Package	Industry Type	Package	RCA Type	Package
MJ2840	TO-3	2N3055	TO-3	MJE29B	Case 199	BD239B	TO-220	MJE105	Case 90	BD278A	TO-220
		2N6471	TO-3					MJE105K	Case 199	BD278A	TO-220
MJ2841	TO-3	2N6254	TO-3	MJE29C	Case 199	BD239C	TO-220	MJE205	Case 90	2N6290	TO-220
		2N6472	TO-3							BD277	TO-220
MJ2901	TO-3	2N6246	TO-3	MJE30	Case 199	BD240	TO-220	MJE205K	Case 199	BD277	TO-220
		2N6249	TO-3								
MJ2940	TO-3	2N6246	TO-3	MJE30A	Case 199	BD240A	TO-220	MJE340K	Case 199	TA8863B	TO-220
		BDX18N	TO-3								
MJ2941	TO-3	2N6247	TO-3	MJE30B	Case 199	BD240B	TO-220	MJE341K	Case 199	TA8863J	TO-220
MJ3000	TO-3	2N6384	TO-3								
MJ3001	TO-3	2N6385	TO-3	MJE30C	Case 199	BD240C	TO-220	MJE344K	Case 199	TA8865J	TO-220
MJ3010	TO-3	BUX16B	TO-3								
MJ3011	TO-3	BUX16B	TO-3	MJE31	Case 199	BD241	TO-220	MJE370	Case 77	RCA30	TO-220
MJ3026	TO-3	2N5839	TO-3					MJE370K	Case 199	BD242	TO-220
MJ3027	TO-3	2N5840	TO-3	MJE31A	Case 199	BD241A	TO-220				
		BUX126	TO-3								
MJ3028	TO-3	2N5840	TO-3	MJE31B	Case 199	BD241B	TO-220	MJE371	Case 77	RCA30	TO-220
		BUX126	TO-3					MJE520	Case 77	RCA29	TO-220
MJ3029	TO-3	BUX16A	TO-3	MJE31C	Case 199	BD241C	TO-220	MJE520K	Case 199	BD241	TO-220
MJ3030	TO-3	BUX16C	TO-3								
MJ3101	TO-66	2N3878	TO-66	MJE32	Case 199	BD242	TO-220	MJE521	Case 77	RCA29	TO-220
MJ3201	TO-66	BUX67A	TO-66					MJE700	TO-126	RCA125	TO-220
MJ3202	TO-66	2N3585	TO-3	MJE32A	Case 199	BD242A	TO-220			2N6667	TO-220
		BUX67B	TO-66					MJE701	TO-126	RCA125	TO-220
MJ3430	TO-3	2N5840	TO-3	MJE32B	Case 199	BD242B	TO-220	MJE702	TO-126	RCA126	TO-220
		BUX18B	TO-3							2N6668	TO-220
MJ3583	TO-66	2N6211	TO-3	MJE32C	Case 199	BD242C	TO-220	MJE703	TO-126	RCA126	TO-220
MJ3584	TO-66	2N6212	TO-66							2N6668	TO-220
MJ3585	TO-66	2N6212	TO-66	MJE33	Case 199	2N6486	TO-220	MJE800	TO-126	2N6387	TO-220
MJ3701	TO-66	2N5956	TO-66							RCA120	TO-220
MJ3760	TO-3	BU126	TO-3	MJE33A	Case 199	2N6487	TO-220	MJE801	TO-126	2N6387	TO-220
MJ3761	TO-3	BU126	TO-3							RCA120	TO-220
MJ3771	TO-3	2N3771	TO-3	MJE33B	Case 199	2N6488	TO-220	MJE802	TO-126	2N6388	TO-220
MJ3772	TO-3	2N3772	TO-3							RCA121	TO-220
MJ3773	TO-3	2N3773	TO-3	MJE34	Case 199	2N6489	TO-220	MJE803	TO-126	2N6388	TO-220
MJ4000	TO-3	2N6384	TO-3							RCA121	TO-220
		RCA1000	TO-3	MJE34A	Case 199	2N6490	TO-220	MJE1090	Case 90	2N6667	TO-220
MJ4001	TO-3	2N6385	TO-3							BDX34A	TO-220
		RCA1001	TO-3	MJE34B	Case 199	2N6491	TO-220	MJE1091	Case 90	2N6667	TO-220
MJ4010	TO-3	2N6649	TO-204MA*							BDX34A	TO-220
		2N6667	TO-3	MJE41	Case 199	BD243	TO-220	MJE1092	Case 90	2N6667	TO-220
MJ4011	TO-3	2N6650	TO-204MA*							BDX34B	TO-220
		2N6668	TO-3	MJE41A	Case 199	BD243A	TO-220	MJE1093	Case 90	2N6667	TO-220
MJ4240	TO-66	2N6212	TO-66							BDX34B	TO-220
MJ4502	TO-3	2N6248	TO-3	MJE41B	Case 199	BD243B	TO-220	MJE1100	Case 90	2N6387	TO-220
MJ5415	TO-39	2N5415	TO-39							BDX33A	TO-220
MJ5416	TO-39	2N5416	TO-39	MJE41C	Case 199	BD243C	TO-220	MJE1101	Case 90	2N6387	TO-220
MJ5600	TO-3	2N3772	TO-3							BDX33A	TO-220
MJ5601	TO-3	2N6258	TO-3	MJE42	Case 199	BD244	TO-220	MJE1102	Case 90	2N6388	TO-220
MJ5602	TO-3	2N3773	TO-3							BDX33B	TO-220
MJ5603	TO-3	2N3773	TO-3	MJE42A	Case 199	BD244A	TO-220	MJE1103	Case 90	2N6388	TO-220
MJ6000	TO-3	2N3772	TO-3							BDX33B	TO-220
MJ6001	TO-3	2N6258	TO-3	MJE42B	Case 199	BD244C	TO-220	MJE1290	Case 90	2N6489	TO-220
MJ6002	TO-3	2N3773	TO-3							2N6490	TO-220
MJ6003	TO-3	2N6258	TO-3	MJE42C	Case 199	BD244C	TO-220	MJE1660	Case 90	2N6486	TO-220
MJ6004	TO-3	2N6258	TO-3								
MJ6302	TO-3	2N3773	TO-3	MJE47	Case 199	TA8863C	TO-220	MJE1661	Case 90	2N6487	TO-220
MJ7000	TO-63	2N3265	TO-63					MJE2010	Case 199	BD244	TO-220
MJE29	Case 199	BD239	TO-220	MJE48	Case 199	TA8863B	TO-220	MJE2011	Case 199	BD244A	TO-220
MJE29A	Case 199	BD239A	TO-220	MJE49	Case 199	TA8863A	TO-220	MJE2020	Case 199	BD243	TO-220

Power Devices Cross-Reference Guide

(Industry Type to Equivalent RCA Type)

POWER TRANSISTORS (CONT'D)

Industry Type	Package	RCA Type	Package	Industry Type	Package	RCA Type	Package	Industry Type	Package	RCA Type	Package
MJE2021	Case 199	BD243A	TO-220	MJE3055	Case 90	RCA3055	TO-220	MJE6044	Case 90	2N6530	TO-220
MJE2050	Case 199	40979	TO-220	MJE3055K	Case 199	RCA3055	TO-220			BDX33B	TO-220
MJE2090	Case 199	RCA8203A	TO-220	MJE3370	Case 199	BD242	TO-220	MJE6045	Case 90	RCA122	TO-220
MJE2091	Case 199	RCA8203A	TO-220	MJE3371	Case 90	40980	TO-220	MM3005	TO-39	BDX33C	TO-220
MJE2092	Case 199	BDX34A	TO-220	MJE3439	TO-126	RCA1C11	TO-220	MM4000	TO-39	RCA1A06	TO-39
MJE2093	Case 199	RCA8203B	TO-220	MJE3740	Case 199	RCP111D	TO-220	MM4001	TO-39	BFT28	TO-39
MJE2100	Case 199	BDX34B	TO-220	MJE3741	Case 199	2N6107	TO-220	MM4002	TO-39	BFT28A	TO-39
MJE2101	Case 199	2N6387	TO-220	MJE4918	Case 199	BD240	TO-220	MM4003	TO-39	BFT28B	TO-39
MJE2102	Case 199	BDX33A	TO-220	MJE4919	Case 199	BD240A	TO-220	MM5005	TO-39	BFT28C	TO-39
MJE2103	Case 199	2N6388	TO-220	MJE4920	Case 199	BD240B	TO-220			40634	TO-39
MJE2160	Case 90	BDX33B	TO-220	MJE4921	Case 199	BD239	TO-220			RCA1A05	TO-39
MJE2360	Case 199	TA8863B	TO-220	MJE4922	Case 199	BD239A	TO-220	MPSU01	Case 152	RCP705	TO-202
MJE2361	Case 199	TA8863E	TO-220	MJE4923	Case 199	BD239B	TO-220	MPSU02	Case 152	RCP701B	TO-202
MJE2370	Case 199	TA8863A	TO-220	MJE5655	Case 199	TA8863J	TO-220	MPSU05	Case 152	RCP701B	TO-202
MJE2371	Case 199	2N6109	TO-220	MJE5656	Case 199	TA8863F	TO-220	MPSU06	Case 152	RCP701C	TO-202
MJE2480	Case 199	BD240	TO-220	MJE5657	Case 199	TA8863E	TO-220	MPSU07	Case 152	RCP701D	TO-202
MJE2481	Case 199	2N6107	TO-220	MJE5974	Case 199	2N6489	TO-220	MPSU10	Case 152	RCP111D	TO-202
MJE2482	Case 199	BD240A	TO-220	MJE5975	Case 199	2N6490	TO-220	MPSU51	Case 152	RCP704	TO-202
MJE2483	Case 199	BD243	TO-220	MJE5976	Case 199	2N6491	TO-220	MPSU52	Case 152	RCP700A	TO-202
MJE2490	Case 199	2N6290	TO-220	MJE5977	Case 199	2N6486	TO-220	MPSU55	Case 152	RCP700B	TO-202
MJE2481	Case 199	BD243	TO-220	MJE5978	Case 199	2N6487	TO-220	MPSU56	Case 152	RCP700C	TO-202
MJE2482	Case 199	2N6292	TO-220	MJE5979	Case 199	2N6488	TO-220	MPSU57	Case 152	RCP700D	TO-202
MJE2482	Case 199	BD243A	TO-220	MJE5980	Case 199	2N6489	TO-220	NSD102	TO-202	RCP701B	TO-202
MJE2482	Case 199	2N6290	TO-220	MJE5981	Case 199	2N6490	TO-220	NSD103	TO-202	RCP701B	TO-202
MJE2483	Case 199	BD243	TO-220	MJE5982	Case 199	2N6491	TO-220	NSD104	TO-202	RCP701C	TO-202
MJE2483	Case 199	2N6292	TO-220	MJE5983	Case 199	2N6486	TO-220	NSD105	TO-202	RCP701C	TO-202
MJE2483	Case 199	BD243A	TO-220	MJE5984	Case 199	2N6487	TO-220	NSD106	TO-202	RCP701D	TO-202
MJE2490	Case 199	2N6109	TO-220	MJE5984	Case 199	2N6487	TO-220	NSD131	TO-202	RCP113B	TO-202
MJE2490	Case 199	BD244	TO-220	MJE5985	Case 199	2N6488	TO-220	NSD132	TO-202	RCP111B	TO-202
MJE2491	Case 199	2N6107	TO-220	MJE6040	Case 90	RCA125	TO-220	NSD133	TO-202	RCP113C	TO-202
MJE2491	Case 199	BD244A	TO-220	MJE6041	Case 90	BDX34A	TO-220	NSD134	TO-202	RCP111C	TO-202
MJE2520	Case 199	2N6290	TO-220	MJE6041	Case 90	RCA125	TO-220	NSD135	TO-202	RCP111D	TO-202
MJE2521	Case 199	BD239	TO-220	MJE6042	Case 90	BDX34B	TO-220	NSD202	TO-202	RCP700B	TO-202
MJE2521	Case 199	2N6292	TO-220	MJE6042	Case 90	RCA126	TO-220	NSD203	TO-202	RCP700B	TO-202
MJE2521	Case 199	BD239A	TO-220	MJE6042	Case 90	BDX34C	TO-220	NSD204	TO-202	RCP700C	TO-202
MJE2522	Case 199	2N6290	TO-220	MJE6043	Case 90	2N6387	TO-220	NSD205	TO-202	RCP700C	TO-202
MJE2522	Case 199	BD241	TO-220			BDX33A	TO-220	NSD206	TO-202	RCP700D	TO-202
MJE2523	Case 199	2N6292	TO-220					SDT410	TO-3	RCA410	TO-3
MJE2523	Case 199	BD241A	TO-220					SDT411	TO-3	RCA411	TO-3
MJE2801	Case 90	2N6290	TO-220					SDT413	TO-3	RCA413	TO-3
MJE2801	Case 90	2N6487	TO-220					SDT423	TO-3	RCA423	TO-3
MJE2801K	Case 199	2N6487	TO-220					SDT431	TO-3	RCA431	TO-3
MJE2901	Case 90	2N6107	TO-220					SDT6901	TO-66	2N6078	TO-66
MJE2901	Case 90	2N6490	TO-220					SDT6902	TO-66	2N6078	TO-66
MJE2901K	Case 199	2N6490	TO-220					SDT6903	TO-66	2N6078	TO-66
MJE2955	Case 90	2N6490	TO-220					SDT6904	TO-66	2N6078	TO-66
MJE2955	Case 90	40878	TO-220					SDT6905	TO-66	2N6078	TO-66
MJE2955K	Case 199	2N6490	TO-220					SDT6906	TO-66	2N6078	TO-66
MJE2955K	Case 199	40878	TO-220					SDT6907	TO-66	2N6078	TO-66
MJE3054	Case 199	RCA3054	TO-220					SDT6908	TO-66	2N6078	TO-66

Power Devices Cross-Reference Guide (Industry Type to Equivalent RCA Type)

POWER TRANSISTORS (CONT'D)

Industry Type	Package	RCA Type	Package	Industry Type	Package	RCA Type	Package	Industry Type	Package	RCA Type	Package
SDT7601	TO-3	2N5039	TO-3	T1484	TO-39	2N697	TO-39	TIP41B	TO-220	BD243B	TO-220
SDT7602	TO-3	2N5039	TO-3	T1492	TO-39	40407	TO-39			RCA41B	TO-220
SDT7603	TO-3	2N5038	TO-3	T1493	TO-39	2N1613	TO-39			TIP41B	TO-220
SDT7604	TO-3	2N6496	TO-3	TIP29	TO-220	BD239	TO-220	TIP41C	TO-220	BD243C	TO-220
SDT7605	TO-3	2N6249	TO-3			RCA29	TO-220			RCA41C	TO-220
SDT7607	TO-3	2N5039	TO-3			TIP29	TO-220			TIP41C	TO-220
SDT7608	TO-3	2N5039	TO-3	TIP29A	TO-220	BD239A	TO-220	TIP42	TO-220	BD244	TO-220
SDT7609	TO-3	2N5038	TO-3			RCA29A	TO-220			RCA42	TO-220
SDT7610	TO-3	2N6354	TO-3			TIP29A	TO-220			TIP42	TO-220
SDT7731	TO-3	2N6470	TO-3	TIP29B	TO-220	BD239B	TO-220	TIP42A	TO-220	BD244A	TO-220
SDT7732	TO-3	2N6471	TO-3			RCA29B	TO-220			RCA42A	TO-220
SDT7733	TO-3	2N6472	TO-3			TIP29B	TO-220			TIP42A	TO-220
SDT8002	TO-63	2N3266	TO-63	TIP29C	TO-220	BD239C	TO-220	TIP42B	TO-220	BD244B	TO-220
SDT8003	TO-63	2N3265	TO-63			RCA29C	TO-220			RCA42B	TO-220
SDT8012	TO-63	2N3266	TO-63			TIP29C	TO-220			TIP42B	TO-220
SDT8013	TO-63	2N3265	TO-63	TIP30	TO-220	BD240	TO-220	TIP42C	TO-220	BD244C	TO-220
SDT8015	TO-63	2N3266	TO-63			RCA30	TO-220			RCA42C	TO-220
SDT8016	TO-63	2N3265	TO-63			TIP30	TO-220			TIP42C	TO-220
SDT8105	Radial	2N3264	Radial	TIP30A	TO-220	BD240A	TO-220	TIP110	TO-220	BDX33A	TO-220
SDT8106	Radial	2N3263	Radial			RCA30A	TO-220	TIP111	TO-220	BDX33B	TO-220
SDT8112	Radial	2N3264	Radial			TIP30A	TO-220	TIP112	TO-220	BDX33C	TO-220
SDT8113	Radial	2N3263	Radial	TIP30B	TO-220	BD240B	TO-220	TIP115	TO-220	BDX34A	TO-220
SDT8301	TO-63	2N3266	TO-63			RCA30B	TO-220	TIP116	TO-220	BDX34B	TO-220
SDT8302	TO-63	2N3265	TO-63			TIP30B	TO-220	TIP117	TO-220	BDX34C	TO-220
SDT8303	TO-63	2N3266	TO-63	TIP30C	TO-220	BD240C	TO-220	TIP120	TO-220	BDX33A	TO-220
SDT8304	TO-63	2N3265	TO-63			RCA30C	TO-220			RCA120	TO-220
SDT9201	TO-3	2N3055	TO-3			TIP30C	TO-220			TIP120	TO-220
SDT9202	TO-3	2N6254	TO-3	TIP31	TO-220	BD241	TO-220	TIP121	TO-220	BDX33B	TO-220
SDT9203	TO-3	2N4348	TO-3			RCA31	TO-220			RCA121	TO-220
SDT9204	TO-3	2N4348	TO-3			TIP31	TO-220			TIP121	TO-220
SDT9205	TO-3	2N3055	TO-3	TIP31A	TO-220	BD241A	TO-220	TIP122	TO-220	BDX33C	TO-220
SDT9206	TO-3	2N3055	TO-3			RCA31A	TO-220			RCA122	TO-220
SDT9207	TO-3	2N6254	TO-3			TIP31A	TO-220			TIP122	TO-220
SDT9208	TO-3	2N4348	TO-3	TIP31B	TO-220	BD241B	TO-220	TIP125	TO-220	BDX34A	TO-220
SDT9209	TO-3	2N4348	TO-3			RCA31B	TO-220			RCA125	TO-220
SDT9210	TO-3	2N6253	TO-3			TIP31B	TO-220			TIP125	TO-220
SDT9701	TO-3	2N6258	TO-3	TIP31C	TO-220	BD241C	TO-220	TIP126	TO-220	BDX34B	TO-220
SDT9702	TO-3	2N4348	TO-3			RCA31C	TO-220			RCA126	TO-220
SDT9703	TO-3	2N4348	TO-3			TIP31C	TO-220			TIP126	TO-220
SDT9704	TO-3	2N6254	TO-3	TIP32	TO-220	BD242	TO-220	TIP127	TO-220	BDX34C	TO-220
SDT9705	TO-3	2N4348	TO-3			RCA32	TO-220			TIP127	TO-220
SDT9706	TO-3	2N4348	TO-3			TIP32	TO-220	TIP140	TO-218	2N6387	TO-220
SDT9707	TO-3	2N3055	TO-3	TIP32A	TO-220	BD242A	TO-220	TIP141	TO-218	2N6530	TO-220
SDT9801	TO-3	2N6254	TO-3			RCA32A	TO-220	TIP142	TO-218	2N6531	TO-220
SDT9802	TO-3	2N6254	TO-3			TIP32A	TO-220	TIP145	TO-218	2N6666	TO-220
SDT9803	TO-3	2N6254	TO-3	TIP32B	TO-220	BD242B	TO-220	TIP146	TO-218	2N6667	TO-220
SDT9804	TO-3	2N3773	TO-3			RCA32B	TO-220	TIP147	TO-218	2N6668	TO-220
SE9300	TO-220	RCA120	TO-220			TIP32B	TO-220	TIP525	TO-3	BUX27A	TO-3
SE9301	TO-220	RCA121	TO-220	TIP32C	TO-220	BD242C	TO-220	TIP531	TO-3	2N6250	TO-3
SE9302	TO-220	RCA122	TO-220			RCA32C	TO-220	TIP535	TO-3	BUX17A	TO-3
SE9303	TO-3	2N6384	TO-3			TIP32C	TO-220	TIP538	TO-3	2N6250	TO-3
SE9304	TO-3	2N6385	TO-3	TIP33	TO-3P	2N6486	TO-220	TIP539	TO-3	2N6250	TO-3
SPC410	TO-3	RCA410	TO-3	TIP33A	TO-3P	2N6487	TO-220	TIP544	TO-3	2N6248	TO-3
SPC411	TO-3	RCA411	TO-3			2N6488	TO-220	TIP546	TO-3	2N6469	TO-3
SPC413	TO-3	RCA413	TO-3	TIP33B	TO-3P	2N6488	TO-220	TIP640	TO-3	2N6384	TO-3
SPC423	TO-3	RCA423	TO-3	TIP34	TO-3P	2N6489	TO-220	TIP641	TO-3	2N6385	TO-3
SPC431	TO-3	RCA431	TO-3	TIP34A	TO-3P	2N6490	TO-220	TIP642	TO-3	2N6385	TO-3
STS410	TO-3	RCA410	TO-3	TIP34B	TO-3P	2N6491	TO-220	TIP645	TO-3	2N6666	TO-3
STS411	TO-3	RCA411	TO-3			BD243	TO-220	TIP646	TO-3	2N6667	TO-3
STS413	TO-3	RCA413	TO-3	TIP41	TO-220	RCA41	TO-220	TIP647	TO-3	2N6668	TO-3
STS423	TO-3	RCA423	TO-3			TIP41	TO-220	TIP2955	TO-3P	2N6490	TO-220
STS431	TO-3	RCA431	TO-3	TIP41A	TO-220	BD243A	TO-220			40878	TO-220
T1482	TO-39	40311	TO-39			RCA41A	TO-220			RCA3054	TO-220
						TIP41A	TO-220				

Power Devices Cross-Reference Guide

(Industry Type to Equivalent RCA Type)

POWER TRANSISTORS (CONT'D)

Industry Type	Package	RCA Type	Package	Industry Type	Package	RCA Type	Package	Industry Type	Package	RCA Type	Package
TIP3055	TO-3P	RCA3055	TO-220	BstB0106C	MU22	S2062A	TO-220	BstC0326	SC88	2N1849	TO-48
TIP5530	TO-3P	2N6099	TO-220	BstB0113C	MU22	S2062B	TO-220	BstC0313S6	SC88	2N1846	TO-48
TS2218	TO-39	2N1613	TO-39	BstB0126C	MU22	S2062D	TO-220	BstC0326S6	SC88	2N1849	TO-48
TS2219	TO-39	2N1711	TO-39	BstB0133C	MU22	S2062E	TO-220	BstC0506E	TO-66	2N3228	TO-66
TS2904	TO-39	40406	TO-39	BstB0140C	MU22	S2062M	TO-220	BstC0513E	TO-66	2N3228	TO-66
SILICON CONTROLLED RECTIFIERS				BstB0106CS4	MU22	S2062A	TO-220	BstC0526E	TO-66	2N3525	TO-66
2N1842	TO-48	2N1842A	TO-48	BstB0113CS4	MU22	S2062B	TO-220	BstC0533E	TO-66	2N4101	TO-66
2N1843	TO-48	2N1843A	TO-48	BstB0126CS4	MU22	S2062D	TO-220	BstC0540E	TO-66	2N4101	TO-66
2N1844	TO-48	2N1844A	TO-48	BstB0133CS4	MU22	S2062E	TO-220	BstC0546E	TO-66	2N4101	TO-66
2N1845	TO-48	2N1845A	TO-48	BstB0140CS4	MU22	S2062M	TO-220	BstC0506F	TO-66	2N3228	TO-66
2N1846	TO-48	2N1846A	TO-48	BstB0106D	MU22	S2062A	TO-220	BstC0513F	TO-66	2N3228	TO-66
2N1847	TO-48	2N1847A	TO-48	BstB0113D	MU22	S2062B	TO-220	BstC0526F	TO-66	2N3525	TO-66
2N1848	TO-48	2N1848A	TO-48	BstB0126D	MU22	S2062D	TO-220	BstC0533F	TO-66	2N4101	TO-66
2N1849	TO-48	2N1849A	TO-48	BstB0133D	MU22	S2062E	TO-220	BstC0540F	TO-66	2N4101	TO-66
2N1850	TO-48	2N1850A	TO-48	BstB0140D	MU22	S2062M	TO-220	BstC0506G	TO-66	2N3228	TO-66
2N4441	Case 90	S122F	TO-220	BstB0106E	MU22	S2062A	TO-220	BstC0513G	TO-66	2N3228	TO-66
2N4442	Case 90	S122B	TO-220	BstB0113E	MU22	S2062B	TO-220	BstC0526G	TO-66	2N3525	TO-66
2N4443	Case 90	S122D	TO-220	BstB0126E	MU22	S2062D	TO-220	BstC0533G	TO-66	2N4101	TO-66
2N4444	Case 90	S122M	TO-220	BstB0133E	MU22	S2062E	TO-220	BstC0540G	TO-66	2N4101	TO-66
2N6236	TO-126	S2060Y	TO-220	BstB0140E	MU22	S2062M	TO-220	BstC0546G	TO-66	2N4101	TO-66
2N6237	TO-126	S2060F	TO-220	BstB0106F	MU22	S2062A	TO-220	BstC0506H	TO-66	2N3228	TO-66
2N6238	TO-126	S2060A	TO-220	BstB0113F	MU22	S2062B	TO-220	BstC0513H	TO-66	2N3228	TO-66
2N6239	TO-126	S2060B	TO-220	BstB0126F	MU22	S2062D	TO-220	BstC0526H	TO-66	2N3525	TO-66
2N6240	TO-126	S2060D	TO-220	BstB0133F	MU22	S2062E	TO-220	BstC0533H	TO-66	2N4101	TO-66
2N6241	TO-126	S2060M	TO-220	BstB0140F	MU22	S2062M	TO-220	BstC0546H	TO-66	2N4101	TO-66
10RC10A	TO-48	2N1844A	TO-48	BstB0206B	MU23	S2061A	TO-220	BstC0546H	TO-66	2N4101	TO-66
10RC10AS24	TO-48	2N3650	TO-48	BstB0213B	MU23	S2061B	TO-220	BT102-300R	TO-220	S2800C	TO-220
10RC20A	TO-48	2N1846A	TO-48	BstB0226B	MU23	S2061D	TO-220	BT102-500R	TO-220	S2800E	TO-220
10RC20AS24	TO-48	2N3650	TO-48	BstB0233B	MU23	S2061E	TO-220	BTW30-300	TO-48	2N3657	TO-48
10RC30A	TO-48	2N1848A	TO-48	BstB0206BS4	MU23	S2061A	TO-220	BTW30-400	TO-48	2N3658	TO-48
10RC30AS24	TO-48	2N3651	TO-48	BstB0213BS4	MU23	S2061B	TO-220	BTW30-500	TO-48	S7432M	TO-48
10RC40A	TO-48	2N1849A	TO-48	BstB0226BS5	MU23	S2061B	TO-220	BTW30-600	TO-48	S7432M	TO-48
10RC40AS24	TO-48	2N3652	TO-48	BstB0213BS5	MU23	S2061B	TO-220	BTW31-300	TO-48	2N3657	TO-48
10RC50A	TO-48	2N1850A	TO-48	BstB0226BS5	MU23	S2061D	TO-220	BTW31-400	TO-48	2N3658	TO-48
10RC50AS24	TO-48	S7410M	TO-48	BstB0233BS5	MU23	S2061E	TO-220	BTW31-500	TO-48	S7412M	TO-48
10RC60AS24	TO-48	S7410M	TO-48	BstB0206C	MU23	S2062A	TO-220	BTW31-600	TO-48	S7412M	TO-48
16RC10A	TO-48	2N683	TO-48	BstB0213C	MU23	S2062B	TO-220	BTW47-600	TO-48	S6410M	stud
16RC10AS24	TO-48	2N3650	TO-48	BstB0233C	MU23	S2062E	TO-220	BTW92-600	TO-48	2N3899	stud
16RC20A	TO-48	2N685	TO-48	BstB0240C	MU23	S2062M	TO-220	BTW92-800	TO-48	S6410N	stud
16RC20AS24	TO-48	2N3651	TO-48	BstB0206CS4	MU23	S2062A	TO-220	BTX31-100	TO-48	S7310A	TO-48
16RC30A	TO-48	2N687	TO-48	BstB0213CS4	MU23	S2062B	TO-220	BTX31-200	TO-48	S7310B	TO-48
16RC30AS24	TO-48	2N3652	TO-48	BstB0226CS4	MU23	S2062D	TO-220	BTX31-400	TO-48	S7310D	TO-48
16RC40A	TO-48	2N688	TO-48	BstB0233CS4	MU23	S2062E	TO-220	BTX31-500	TO-48	S7310M	TO-48
16RC40AS24	TO-48	2N3653	TO-48	BstB0240CS4	MU23	S2062M	TO-220	BTX31-600	TO-48	S7310M	TO-48
16RC50A	TO-48	2N689	TO-48	BstB0206D	MU23	S2062A	TO-220	BTX32-100	TO-48	S7310B	TO-48
16RC50AS24	TO-48	S7410M	TO-48	BstB0213D	MU23	S2062B	TO-220	BTX32-400	TO-48	S7310D	TO-48
16RC60A	TO-48	2N690	TO-48	BstB0226D	MU23	S2062D	TO-220	BTX32-500	TO-48	S7310M	TO-48
16RC60AS24	TO-48	S7410M	TO-48	BstB0233D	MU23	S2062E	TO-220	BTX32-600	TO-48	S7310M	TO-48
BstB0106B	MU22	S2061A	TO-220	BstB0240D	MU23	S2062M	TO-220	BTX33-100	TO-48	S6210A	TO-48
BstB0113B	MU22	S2061B	TO-220	BstB0206E	MU23	S2062A	TO-220	BTX33-200	TO-48	S6210B	TO-48
BstB0126B	MU22	S2061D	TO-220	BstB0213E	MU23	S2062B	TO-220	BTX33-400	TO-48	S6210D	TO-48
BstB0133B	MU22	S2061E	TO-220	BstB0226E	MU23	S2062D	TO-220	BTX33-500	TO-48	S6210M	TO-48
BstB0140B	MU22	S2061M	TO-220	BstB0233E	MU23	S2062E	TO-220	BTX33-600	TO-48	S6210M	TO-48
BstB0106BS4	MU22	S2061A	TO-220	BstB0240E	MU23	S2062M	TO-220	BTX70-100	TO-48	S6210A	TO-48
BstB0113BS4	MU22	S2061B	TO-220	BstB0206F	MU23	S2062A	TO-220	BTX70-200	TO-48	S6210B	TO-48
BstB0126BS4	MU22	S2061D	TO-220	BstB0213F	MU23	S2062B	TO-220	BTX70-400	TO-48	S6210D	TO-48
BstB0133BS4	MU22	S2061E	TO-220	BstB0226F	MU23	S2062D	TO-220	BTX70-500	TO-48	S6210M	TO-48
BstB0106BS5	MU22	S2061A	TO-220	BstB0233F	MU23	S2062E	TO-220	BTX70-600	TO-48	S6210M	TO-48
BstB0113BS5	MU22	S2061B	TO-220	BstB0240F	MU23	S2062M	TO-220	BTX71-100	TO-48	S7310B	TO-48
BstB0126BS5	MU22	S2061D	TO-220	BstC0313	SC88	2N1846	TO-48	BTX71-200	TO-48	S7310B	TO-48
BstB0133BS5	MU22	S2061E	TO-220					BTX71-400	TO-48	S7310D	TO-48

Power Devices Cross-Reference Guide (Industry Type to Equivalent RCA Type)

SILICON CONTROLLED RECTIFIERS (CONT'D)

Industry Type	RCA Package	RCA Type	Package	Industry Type	RCA Package	RCA Type	Package	Industry Type	RCA Package	RCA Type	Package
BTX71-500	TO-48	S7310M	TO-48	C33C	press-fit	2N3872	press-fit	C45F	TO-49	TAS8612A	stud
BTX71-600	TO-48	S7310M	TO-48	C33D	press-fit	2N3872	press-fit	C45G	TO-49	TAS8612B	stud
BTX72-100	TO-48	S7310M	TO-48	C33F	press-fit	2N3870	press-fit	C45H	TO-49	TAS8612D	stud
BTX72-200	TO-48	S7310M	TO-48	C33U	press-fit	2N3870	press-fit	C45M	TO-49	TAS8612M	stud
BTX72-400	TO-48	S7310M	TO-48	C34A2	stud	2N3650	TO-48	C45N	TO-49	TAS8612N	stud
BTX72-500	TO-48	S7310M	TO-48	C34B2	stud	2N3651	TO-48	C45U	TO-49	TAS8612A	stud
BTX72-600	TO-48	S7310M	TO-48	C34C2	stud	2N3652	TO-48	C106A	TO-202	C106A	TO-202
BTX73-100	TO-48	2N683	TO-48	C34D2	stud	2N3653	TO-48			S106A	TO-202
BTX73-200	TO-48	2N685	TO-48	C34E2	stud	S7410M	TO-48	C106B	TO-202	C106B	TO-202
BTX73-400	TO-48	2N688	TO-48	C34F2	stud	2N3650	TO-48			S106B	TO-202
BTX73-500	TO-48	2N689	TO-48	C35A	TO-48	2N683	TO-48	C106C	TO-202	C106C	TO-202
BTX73-600	TO-48	2N690	TO-48			2N3896	stud			S106C	TO-202
BTX74-100	TO-48	S6210A	TO-48	C35B	TO-48	2N685	TO-48	C106D	TO-202	C106D	TO-202
BTX74-200	TO-48	S6210B	TO-48			2N3897	stud			S106D	TO-202
BTX74-400	TO-48	S6210D	TO-48	C35C	TO-48	2N687	TO-48	C106F	TO-202	C106F	TO-202
BTX74-500	TO-48	S6210M	TO-48			2N3898	stud			S106F	TO-202
BTX74-600	TO-48	S6210M	TO-48	C35D	TO-48	2N688	TO-48	C106Q	TO-202	C106Q	TO-202
BTY87-400	TO-48	S6210D	stud			2N3898	stud			S106Q	TO-202
BTY87-400R	TO-48	2N3898	stud	C35E	TO-48	2N689	TO-48	C106Y	TO-202	C106Y	TO-202
BTY87-500	TO-48	S6210M	stud			2N3899	stud			S106Y	TO-202
BTY87-500R	TO-48	2N3899	stud	C35F	TO-48	2N682	TO-48	C107A	TO-202	C107A	TO-202
BTY87-600	TO-48	S6210M	stud			2N3896	stud			S107A	TO-202
BTY87-600R	TO-48	2N3899	stud	C35G	TO-48	2N684	TO-48	C107B	TO-202	C107B	TO-202
BTY87-800R	TO-48	S6410N	stud			2N3897	stud			S107B	TO-202
BTY91-400	TO-48	S6210D	stud	C35H	TO-48	2N686	TO-48	C107C	TO-202	C107C	TO-202
BTY91-400R	TO-48	2N3898	stud			2N3898	stud			S107C	TO-202
BTY91-500	TO-48	S6210M	stud	C35M	TO-48	2N690	TO-48	C107D	TO-202	C107D	TO-202
BTY91-500R	TO-48	2N3899	stud			2N3899	stud			S107D	TO-202
BTY91-600	TO-48	S6210M	stud	C35U	TO-48	2N681	TO-48	C107F	TO-202	C107F	TO-202
BTY91-600R	TO-48	2N3899	stud			2N3896	stud			S107F	TO-202
BTY91-800R	TO-48	S6410N	stud	C36A	TO-48	2N1844A	TO-48	C107Q	TO-202	C107Q	TO-202
C20A	stud	S6210A	stud	C36B	TO-48	2N1846A	TO-48			S107Q	TO-202
C20B	stud	S6210B	stud	C36C	TO-48	2N1848A	TO-48	C107Y	TO-202	C107Y	TO-202
C20C	stud	S6210C	stud	C36D	TO-48	2N1849A	TO-48			S107Y	TO-202
C20D	stud	S6210D	stud	C36E	TO-48	2N1850A	TO-48	C122A	TO-220	S122A	TO-220
C20F	stud	S6210A	stud	C36F	TO-48	2N1843A	TO-48			S2800A	TO-220
C20U	stud	S6210A	stud	C36G	TO-48	2N1845A	TO-48	C122B	TO-220	S122B	TO-220
C22A	press-fit	S6200A	press-fit	C36H	TO-48	2N1847A	TO-48			S2800B	TO-220
C22B	press-fit	S6200B	press-fit	C36U	TO-48	2N1842A	TO-48	C122C	TO-220	S122C	TO-220
C22C	press-fit	S6200C	press-fit	C38A	TO-48	2N683	TO-48			S2800C	TO-220
C22D	press-fit	S6200D	press-fit	C38B	TO-48	2N685	TO-48	C122D	TO-220	S122D	TO-220
C22F	press-fit	S6200A	press-fit	C38C	TO-48	2N687	TO-48			S2800D	TO-220
C22U	press-fit	S6200A	press-fit	C38D	TO-48	2N688	TO-48	C122E	TO-220	S122E	TO-220
C30A	stud	2N3896	stud	C38E	TO-48	2N689	TO-48			S2800E	TO-220
C30B	stud	2N3897	stud	C38F	TO-48	2N682	TO-48	C122F	TO-220	S122F	TO-220
C30C	stud	2N3898	stud	C38G	TO-48	2N684	TO-48			S2800F	TO-220
C30D	stud	2N3898	stud	C38M	TO-48	2N686	TO-48	C122G	TO-220	S122G	TO-220
C30P	stud	2N3896	stud	C38U	TO-48	2N681	TO-48			S2800G	TO-220
C30U	stud	2N3896	stud	C40A	TO-48	2N3650	TO-48	C122M	TO-220	S122M	TO-220
C31A	stud	2N3896	stud	C40B	TO-48	2N3651	TO-48			S2800M	TO-220
C31B	stud	2N3897	stud	C40C	TO-48	2N3652	TO-48	C122Y	TO-220	S122A	TO-220
C31C	stud	2N3898	stud							S2800A	TO-220
C31D	stud	2N3898	stud	C40D	TO-48	2N3653	TO-48	C137E	TO-48	2N3899	stud
C31P	stud	2N3896	stud	C40E	TO-48	S7410M	TO-48	C137M	TO-48	2N3899	stud
C31U	stud	2N3896	stud	C40F	TO-48	2N3650	TO-48	C137N	TO-48	S6410N	stud
				C40G	TO-48	2N3651	TO-48				
C32A	press-fit	2N3870	press-fit					C137S	TO-48	S6410N	stud
C32B	press-fit	2N3871	press-fit	C40H	TO-48	2N3652	TO-48	C140A	TO-48	2N3650	TO-48
C32C	press-fit	2N3872	press-fit	C40U	TO-48	2N3650	TO-48	C140B	TO-48	2N3651	TO-48
C32D	press-fit	2N3872	press-fit					C140C	TO-48	2N3652	TO-48
C32F	press-fit	2N3870	press-fit	C45A	TO-49	TAS8612A	stud	C140D	TO-48	2N3653	TO-48
C32U	press-fit	2N3870	press-fit	C45B	TO-49	TAS8612B	stud				
C33A	press-fit	2N3870	press-fit	C45C	TO-49	TAS8612D	stud	C140F	TO-48	2N3654	TO-48
C33B	press-fit	2N3871	press-fit	C45D	TO-49	TAS8612D	stud	C141A	TO-48	2N3655	TO-48
				C45E	TO-49	TAS8612M	stud	C141B	TO-48	2N3656	TO-48

Power Devices Cross-Reference Guide

(Industry Type to Equivalent RCA Type)

SILICON CONTROLLED RECTIFIERS (CONT'D)

Industry Type	Package	RCA Type	Package	Industry Type	Package	RCA Type	Package	Industry Type	Package	RCA Type	Package
C141C	TO-48	2N3657	TO-48	CS0602604	MU22	S107B	TO-202	MCR3000-8	Case 90	S122M	TO-220
C141D	TO-48	2N3658	TO-48	CS0604602	MU22	S108D	TO-202	MCR3818-1	press-fit	S6200A	press-fit
C141F	TO-48	2N3654	TO-48	CS0604604	MU22	S107D	TO-202	MCR3818-3	press-fit	S6200A	press-fit
C220A	stud	S6210A	stud	CS0606602	MU22	S108M	TO-202	MCR3818-5	press-fit	S6200D	press-fit
C220A2	ISOstud	S6220A	ISOstud	CS102603	MU23	S108B	TO-202	MCR3818-7	press-fit	S6200M	press-fit
C220B	stud	S6210B	stud	CS104603	MU23	S108D	TO-202	MCR3835-1	press-fit	2N3870	press-fit
C220B2	ISOstud	S6220B	ISOstud	CS106603	MU23	S108E	TO-202	MCR3835-2	press-fit	2N3870	press-fit
C220C	stud	S6210C	stud	CS108603	MU23	S108M	TO-202	MCR3835-3	press-fit	2N3870	press-fit
C220C2	ISOstud	S6220C	ISOstud	CS302D02	TO-220	S2062B	TO-220	MCR3835-4	press-fit	2N3871	press-fit
C220D	stud	S6210D	stud	CS304D02	TO-220	S2062D	TO-220	MCR3835-5	press-fit	2N3872	press-fit
C220D2	ISOstud	S6220D	ISOstud	CS305D02	TO-220	S2062E	TO-220	MCR3835-6	press-fit	2N3872	press-fit
C220E	stud	S6210M	ISOstud	CS306D02	TO-220	S2062M	TO-220	MCR3835-7	press-fit	2N3873	press-fit
C220E2	ISOstud	S6220M	ISOstud	EC106A1	TO-202	S106A	TO-202	MCR3835-8	press-fit	2N3873	press-fit
C220F	stud	S6210A	stud	EC106B1	TO-202	S106B	TO-202	MCR3918-1	stud	S6210A	stud
C220F2	ISOstud	S6220A	ISOstud	EC106M1	TO-202	S106M	TO-202	MCR3518-3	stud	S6210A	stud
C220U	stud	S6210A	stud	EC107A1	TO-202	S107A	TO-202	MCR3918-5	stud	S6210D	stud
C220U2	ISOstud	S6220A	ISOstud	EC107B1	TO-202	S107B	TO-202	MCR3918-7	stud	S6210M	stud
C222A	press-fit	S6200A	press-fit	EC107M1	TO-202	S107M	TO-202	MCR3935-1	stud	2N3896	stud
C222B	press-fit	S6200D	press-fit	IR140A	TO-48	2N3650	TO-48	MCR3936-2	stud	2N3896	stud
C222C	press-fit	S6200D	press-fit	IR140B	TO-48	2N3651	TO-48	MCR9935-3	stud	2N3896	stud
C222D	press-fit	S6200D	press-fit	IR140C	TO-48	2N3652	TO-48	MCR3935-4	stud	2N3897	stud
C222E	press-fit	S6200M	press-fit	IR140D	TO-48	2N3653	TO-48	MCR3935-5	stud	2N3898	stud
C222F	press-fit	S6200A	press-fit	IR140F	TO-48	2N3654	TO-48	MCR3935-6	stud	2N3898	stud
C222U	press-fit	S6200A	press-fit	IR141A	TO-48	2N3655	TO-48	MCR3935-7	stud	2N3899	stud
CS5-2T	TO-66	2N3228	TO-66	IR141B	TO-48	2N3656	TO-48	MCR3935-8	stud	2N3899	stud
CS5-4T	TO-66	2N3525	TO-66	IR141C	TO-48	2N3657	TO-48	NL-C35A	TO-48	2N683	TO-48
CS5-5.5T	TO-66	2N4101	TO-66	IR141D	TO-48	2N3658	TO-48	NL-C35B	TO-48	2N685	TO-48
CS10-02M	press-fit	S6200A	press-fit	IR141F	TO-48	2N3654	TO-48	NL-C35C	TO-48	2N687	TO-48
CS10-02N	stud	S6210A	stud	MCR106-1	Case 77	S2061Y	TO-220	NL-C35D	TO-48	2N688	TO-48
CS10-05M	press-fit	S6200A	press-fit	MCR106-2	Case 77	S2061F	TO-220	NL-C35E	TO-48	2N689	TO-48
CS10-05N	stud	S6210A	stud	MCR106-3	Case 77	S2061A	TO-220	NL-C35G	TO-48	2N684	TO-48
CS10-1M	press-fit	S6200A	press-fit	MCR106-4	Case 77	S2061B	TO-220	NL-C35H	TO-48	2N686	TO-48
CS10-1N	stud	S6210A	stud	MCR106-5	Case 77	S2061C	TO-220	NL-C35M	TO-48	2N689	TO-48
CS10-2M	press-fit	S6200B	press-fit	MCR106-6	Case 77	S2061D	TO-220	NL-C36A	TO-48	2N1844A	TO-48
CS10-2N	stud	S6210B	stud	MCR106-7	Case 77	S2061E	TO-220	NL-C36B	TO-48	2N1846A	TO-48
CS10-4M	press-fit	S6200D	press-fit	MCR106-8	Case 77	S2061M	TO-220	NL-C36C	TO-48	2N1848A	TO-48
CS10-4N	stud	S6210D	stud	MCR107-1	Case 77	S2062Y	TO-220	NL-C36D	TO-48	2N1849A	TO-48
CS10-6M	press-fit	S6200M	press-fit	MCR107-2	Case 77	S2062F	TO-220	NL-C36E	TO-48	2N1850A	TO-48
CS10-6N	stud	S6210D	stud	MCR107-3	Case 77	S2062A	TO-220	NL-C36G	TO-48	2N1845A	TO-48
CS20-05M	press-fit	S6200A	press-fit	MCR107-4	Case 77	S2062B	TO-220	NL-C36H	TO-48	2N1847A	TO-48
CS20-05N	stud	S6210A	stud	MCR107-5	Case 77	S2062C	TO-220	NL-C40A	TO-48	2N3650	TO-48
CS20-1M	press-fit	S6200A	press-fit	MCR107-6	Case 77	S2062D	TO-220	NL-C40B	TO-48	2N3651	TO-48
CS20-1N	stud	S6210A	stud	MCR107-7	Case 77	S2062E	TO-220	NL-C40C	TO-48	2N3652	TO-48
CS20-2M	press-fit	S6200B	press-fit	MCR406-1	Case 90	S2060Y	TO-220	NL-C40D	TO-48	2N3654	TO-48
CS20-2N	stud	S6210B	stud	MCR406-2	Case 90	S2060F	TO-220	NL-C40E	TO-48	S7410M	TO-48
CS20-4M	press-fit	S6200D	press-fit	MCR406-3	Case 90	S2060A	TO-220	NL-C40G	TO-48	2N3651	TO-48
CS20-4N	stud	S6210D	stud	MCR406-4	Case 90	S2060B	TO-220	NL-C40H	TO-48	2N3652	TO-48
CS20-6M	press-fit	S6200M	press-fit	MCR407-1	Case 90	S2061Y	TO-220	NL570M	TO-48	2N690	TO-48
CS20-6N	stud	S6210M	stud	MCR407-2	Case 90	S2061F	TO-220	PS08	press-fit	S6200A	press-fit
CS35-02M	press-fit	2N3870	press-fit	MCR407-3	Case 90	S2061A	TO-220	PS18	press-fit	S6200A	press-fit
CS35-02N	stud	2N3896	stud	MCR407-4	Case 90	S2061B	TO-220	PS020	press-fit	S6200A	press-fit
CS35-05M	press-fit	2N3870	press-fit	MCR1718-5	TO-48	2N3653	TO-48	PS28	press-fit	S6200B	press-fit
CS35-05N	stud	2N3896	stud	MCR1718-6	TO-48	2N3653	TO-48	PS035	press-fit	2N3870	press-fit
CS35-1M	press-fit	2N3870	press-fit	MCR1718-7	TO-48	S7410M	TO-48	PS38	press-fit	S6200D	press-fit
CS35-1N	stud	2N3896	stud	MCR1718-8	TO-48	S7410M	TO-48	PS48	press-fit	S6200D	press-fit
CS35-2M	press-fit	2N3871	press-fit	MCR3000-1	Case 90	S122F	TO-220	PS58	press-fit	S6200M	press-fit
CS35-2N	stud	2N3897	stud	MCR3000-2	Case 90	S122F	TO-220	PS68	press-fit	S6200M	press-fit
CS35-4M	press-fit	2N3872	press-fit	MCR3000-3	Case 90	S122A	TO-220	PS120	press-fit	S6200M	press-fit
CS35-4N	stud	2N3898	stud	MCR3000-4	Case 90	S122B	TO-220	PS135	press-fit	2N3870	press-fit
CS35-6M	press-fit	2N3873	press-fit	MCR3000-5	Case 90	S122C	TO-220	PS220	press-fit	S6200B	press-fit
CS35-6N	stud	2N3899	stud	MCR3000-6	Case 90	S122D	TO-220	PS235	press-fit	2N3871	press-fit
CS0602602	MU22	S108B	TO-202	MCR3000-7	Case 90	S122E	TO-220	PS320	press-fit	S6200D	press-fit

Power Devices Cross-Reference Guide (Industry Type to Equivalent RCA Type)

SILICON CONTROLLED RECTIFIERS (CONT'D)

Industry Type	Package	RCA Type	Package	Industry Type	Package	RCA Type	Package	Industry Type	Package	RCA Type	Package
PS335	press-fit	2N3872	press-fit	RTU0202	stud	2N3896	stud	S4010B	ISOstud	S6220D	ISOstud
PS420	press-fit	S6200D	press-fit	RTU0205	stud	2N3896	stud	S4010G	press-fit	S6200D	press-fit
PS435	press-fit	2N3872	press-fit	RTU0210	stud	2N3896	stud	S4010H	stud	S6210D	stud
PS520	press-fit	S6200M	press-fit	RTU0220	stud	2N3897	stud	S4016B	ISOstud	S6220D	ISOstud
PS535	press-fit	2N3873	press-fit	RTU0230	stud	2N3898	stud	S4016G	press-fit	S6200D	press-fit
PS620	press-fit	S6200M	press-fit	RTU0240	stud	2N3898	stud	S4016H	stud	S6210D	stud
PS635	press-fit	2N3873	press-fit	RTU0250	stud	S6410N	stud	S4025G	press-fit	2N3872	press-fit
RCA106A	TO-220AB	S2060A	TO-220AB	RTU0260	stud	S6410N	stud	S4025H	stud	2N3898	stud
RCA106B	TO-220AB	S2060B	TO-220AB	RTU0602	stud	2N3896	stud	S4035G	press-fit	2N3872	press-fit
RCA106D	TO-220AB	S2060D	TO-220AB	RTU0605	stud	2N3896	stud	S4035H	stud	2N3898	stud
RCA106E	TO-220AB	S2060E	TO-220AB	RTU0610	stud	2N3896	stud	S6003RS2	TO-220	S2060M	TO-220
RCA106F	TO-220AB	S2060F	TO-220AB	RTU0620	stud	2N3897	stud	S6003RS3	TO-220	S2061M	TO-220
RCA106Q	TO-220AB	S2060Q	TO-220AB	RTU0630	stud	2N3898	stud	S6006B	ISOstud	S6220M	ISOstud
RCA106M	TO-220AB	S2060M	TO-220AB	RTU0640	stud	2N3898	stud	S6006G	press-fit	S6200M	press-fit
RCA106Y	TO-220AB	S2060Y	TO-220AB	RTU0650	stud	2N3899	stud	S6006H	stud	S6210M	stud
RCA107A	TO-220AB	S2061A	TO-220AB	RTU0660	stud	2N3899	stud	S6008G	press-fit	S6200M	press-fit
RCA107B	TO-220AB	S2061B	TO-220AB	RTU0705	stud	2N3896	stud	S6008H	stud	S6210M	stud
RCA107C	TO-220AB	S2061C	TO-220AB	RTU0710	stud	2N3896	stud	S6010B	ISOstud	S6220M	ISOstud
RCA107D	TO-220AB	S2061D	TO-220AB	RTU0720	stud	2N3897	stud	S6010G	press-fit	S6200M	press-fit
RCA107E	TO-220AB	S2061E	TO-220AB	RTU0730	stud	2N3898	stud	S6010H	stud	S6210M	stud
RCA107F	TO-220AB	S2061F	TO-220AB	RTU0740	stud	2N3898	stud	S6016B	ISOstud	S6220M	ISOstud
RCA107Q	TO-220AB	S2061Q	TO-220AB	RTU0750	stud	2N3899	stud	S6016G	press-fit	S6200M	press-fit
RCA107M	TO-220AB	S2061M	TO-220AB	RTU0760	stud	2N3899	stud	S6016H	stud	S6210M	stud
RCA107Y	TO-220AB	S2061Y	TO-220AB	S0525G	press-fit	2N3870	press-fit	S6025G	press-fit	2N3873	press-fit
RCA108A	TO-220AB	S2062A	TO-220AB	S1003RS2	TO-220	S2060A	TO-220	S6025H	stud	2N3899	stud
RCA108B	TO-220AB	S2062B	TO-220AB	S1003RS3	TO-220	S2061A	TO-220	S6035G	press-fit	2N3873	press-fit
RCA108C	TO-220AB	S2062C	TO-220AB	S1006B	ISOstud	S6220A	ISOstud	S6035H	stud	2N3899	stud
RCA108D	TO-220AB	S2062D	TO-220AB	S1006G	press-fit	S6200A	press-fit	S8025C	TO-3	S6410N	stud
RCA108E	TO-220AB	S2062E	TO-220AB	S1006H	stud	S6210A	stud	S8025D	ISOstud	S6420N	ISOstud
RCA108F	TO-220AB	S2062F	TO-220AB	S1008B	ISOstud	S6220A	ISOstud	S8025G	press-fit	S6400N	press-fit
RCA108Q	TO-220AB	S2062Q	TO-220AB	S1008G	press-fit	S6200A	press-fit	S8025H	stud	S6410N	stud
RCA108M	TO-220AB	S2062M	TO-220AB	S1008H	stud	S6210A	stud	S8035G	press-fit	S6400N	press-fit
RCA108Y	TO-220AB	S2062Y	TO-220AB	S1010B	ISOstud	S6220A	ISOstud	S8035H	stud	S6410N	stud
RTS0202	press-fit	S6200A	press-fit	S1010G	press-fit	S6200A	press-fit	SPS08	stud	S6210A	stud
RTS0205	press-fit	S6200A	press-fit	S1010H	stud	S6210A	stud	SPS18	stud	S6210A	stud
RTS0210	press-fit	S6200A	press-fit	S1016B	ISOstud	S6220A	ISOstud	SPS20	stud	S6210A	stud
RTS0220	press-fit	S6200B	press-fit	S1016G	press-fit	S6200A	press-fit	SPS28	stud	S6210B	stud
RTS0230	press-fit	S6200D	press-fit	S1016H	stud	S6210A	stud	SPS38	stud	S6210D	stud
RTS0240	press-fit	S6200D	press-fit	S1025G	press-fit	2N3870	press-fit	SPS48	stud	S6210D	stud
RTS0250	press-fit	S6200M	press-fit	S1025H	stud	2N3896	stud	SPS58	stud	S6210M	stud
RTS0260	press-fit	S6200M	press-fit	S1035G	press-fit	2N3870	press-fit	SPS68	stud	S6210M	stud
RTS0502	press-fit	S6200A	press-fit	S1035H	stud	2N3896	stud	SPS120	stud	S6210A	stud
RTS0505	press-fit	S6200A	press-fit	S2003RS2	TO-220	S2060B	TO-220	SPS220	stud	S6210B	stud
RTS0510	press-fit	S6200A	press-fit	S2003RS3	TO-220	S2061B	TO-220	SPS320	stud	S6210D	stud
RTS0520	press-fit	S6200B	press-fit	S2006B	ISOstud	S6220B	ISOstud	SPS420	stud	S6210D	stud
RTS0530	press-fit	S6200D	press-fit	S2006G	press-fit	S6200B	press-fit	SPS520	stud	S6210M	stud
RTS0540	press-fit	S6200D	press-fit	S2006H	stud	S6210B	stud	SPS620	stud	S6210M	stud
RTS0550	press-fit	S6200M	press-fit	S2008B	ISOstud	S6220B	ISOstud	TA-6-3-100	TO-66	S3704A	TO-66
RTS0602	press-fit	S6200A	press-fit	S2008G	press-fit	S6200B	press-fit	TA-6-3-200	TO-66	S3704B	TO-66
RTS0605	press-fit	S6200A	press-fit	S2008H	stud	S6210B	stud	TA-6-3-400	TO-66	S3704D	TO-66
RTS0610	press-fit	S6200A	press-fit	S2010B	ISOstud	S6220B	ISOstud	TA-6-3-500	TO-66	S3704E	TO-66
RTS0620	press-fit	S6200B	press-fit	S2010G	press-fit	S6200B	press-fit	TA-6-3-600	TO-66	S3704M	TO-66
RTS0630	press-fit	S6200D	press-fit	S2010H	stud	S6210B	stud	TA-6-3-700	TO-66	S3704S	TO-66
RTS0640	press-fit	S6200D	press-fit	S2016B	ISOstud	S6220B	ISOstud	TA-6-6-100	TO-66	2N3668	TO-66
RTS0650	press-fit	S6200M	press-fit	S2016G	press-fit	S6200B	press-fit	TA-6-6-400	TO-66	2N3670	TO-66
RTS0660	press-fit	S6200M	press-fit	S2016H	stud	S6210B	stud	TA-6-6-500	TO-66	2N4103	TO-66
RTU0102	stud	S6210A	stud	S2025G	press-fit	2N3871	press-fit	TA-6-6-600	TO-66	2N4103	TO-66
RTU0105	stud	S6210A	stud	S2025H	stud	2N3897	stud	TA-6-7-100	TO-48	S7310B	TO-48
RTU0110	stud	S6210A	stud	S2035G	press-fit	2N3871	press-fit	TA-6-7-200	TO-48	S7310B	TO-48
RTU0120	stud	S6210D	stud	S2035H	stud	2N3897	stud	TA-6-7-400	TO-48	S7310D	TO-48
RTU0130	stud	S6210D	stud	S4006B	ISOstud	S6220D	ISOstud	TA-6-7-500	TO-48	S7310M	TO-48
RTU0140	stud	S6210D	stud	S4006G	press-fit	S6200D	press-fit	TA-6-7-600	TO-48	S7310M	TO-48
RTU0150	stud	S6210M	stud	S4006H	stud	S6210D	stud	TA-6-10-100	TO-48	S7310B	TO-48
RTU0160	stud	S6210M	stud								

Power Devices Cross-Reference Guide

(Industry Type to Equivalent RCA Type)

SILICON CONTROLLED RECTIFIERS (CONT'D)

Industry Type	RCA Package	RCA Type	Package	Industry Type	RCA Package	RCA Type	Package	Industry Type	RCA Package	RCA Type	Package
TA6-10-200	TO-48	S7310B	TO-48	40216	TO-48	S6493M	TO-48	2N6074	Case 77	2N5757	TO-5
TA6-10-400	TO-48	S7310D	TO-48	40504	TO-66	S2710B	TO-66	2N6075	Case 77	2N5757	TO-5
TA6-10-500	TO-48	S7310M	TO-48	40505	TO-66	S2710D	TO-66	2N6139	stud	2N5569	stud
TA6-10-600	TO-48	S7310M	TO-48	40506	TO-66	S2710M	TO-66	2N6140	stud	2N5570	stud
TA6-15-100	TO-48	S6210A	TO-48	40553	TO-66	S3700B	TO-66	2N6141	stud	T4111M	stud
TA6-15-200	TO-48	S6210B	TO-48	40554	TO-66	S3700D	TO-66	2N6142	stud	2N5569	stud
TA6-15-400	TO-48	S6210D	TO-48	40555	TO-66	S3700M	TO-66	2N6143	stud	2N5570	stud
TA6-15-500	TO-48	S6210M	TO-48	40654	TO-5	S2600B	TO-5	2N6144	stud	T4111M	stud
TA6-15-600	TO-48	S6210M	TO-48	40655	TO-5	S2600D	TO-5	2N6145	ISOstud	T4120B	ISOstud
TA6-20-100	TO-48	S6210A	TO-48	40656	TO-5	S2620B	TO-5	2N6146	ISOstud	T4120D	ISOstud
TA6-20-200	TO-48	S6210B	TO-48	40657	TO-5	S2620D	TO-5	2N6147	ISOstud	T4120M	ISOstud
TA6-20-400	TO-48	S6210D	TO-48	40658	TO-5	S2610B	TO-5	2N6151	Case 90	T2800B	TO-220
TA6-20-500	TO-48	S6210M	TO-48	40659	TO-5	S2610D	TO-5	2N6152	Case 90	T2800D	TO-220
TA6-20-600	TO-48	S6210M	TO-48	40680	stud	S6420A	stud	2N6153	Case 90	T2800M	TO-220
TA6-35-100	TO-48	S6410A	stud	40681	stud	S6420B	stud	2N6154	Case 90	T2802B	TO-220
TA6-35-200	TO-48	S6410B	stud	40682	ISOstud	S6420D	ISOstud	2N6155	Case 90	T2802D	TO-220
TA6-35-400	TO-48	S6410D	stud	40683	ISOstud	S6420M	ISOstud	2N6156	Case 90	T2802M	TO-220
TA6-35-500	TO-48	S6410M	stud	40735	TO-48	S7410M	TO-48	2N6157	press-fit	T6401B	press-fit
TA6-35-600	TO-48	S6410M	stud	40749	TO-48	S6200M	TO-48	2N6158	press-fit	T6401D	press-fit
TIC106A	TO-220	S2060A	TO-220	40750	press-fit	S6200B	press-fit	2N6159	press-fit	T6401M	press-fit
TIC106B	TO-220	S2060B	TO-220	40751	press-fit	S6200D	press-fit	2N6160	stud	T6411B	stud
TIC106C	TO-220	S2060C	TO-220	40752	press-fit	S6200M	press-fit	2N6161	stud	T6411D	stud
TIC106D	TO-220	S2060D	TO-220	40753	stud	S6210A	stud	2N6162	stud	T6411M	stud
TIC106F	TO-220	S2060F	TO-220	40754	stud	S6210B	stud	2N6163	ISOstud	T6421B	ISOstud
TIC106Y	TO-220	S2060Y	TO-220	40755	stud	S6210D	stud	2N6164	ISOstud	T6421D	ISOstud
TIC116A	TO-220	S122A	TO-220	40756	stud	S6210M	stud	2N6165	ISOstud	T6421M	ISOstud
		S2800A	TO-220	40757	ISOstud	S6220A	ISOstud	2N6342	TO-220	T2802B	TO-220
TIC116B	TO-220	S122B	TO-220	40758	ISOstud	S6220B	ISOstud	2N6343	TO-220	T2802D	TO-220
		S2800B	TO-220	40759	ISOstud	S6220D	ISOstud	2N6344	TO-220	T2802M	TO-220
TIC116C	TO-220	S122C	TO-220	40760	ISOstud	S6220M	ISOstud	2N6345	TO-220	T2802N	TO-220
TIC116D	TO-220	S122D	TO-220	40833	TO-5	S2600M	TO-5	2N6346	TO-220	T2800B	TO-220
TIC116E	TO-220	S122E	TO-220	40834	TO-5	S2620M	TO-5	2N6347	TO-220	T2800D	TO-220
TIC116F	TO-220	S122F	TO-220	40835	TO-5	S2610M	TO-5	2N6348	TO-220	T2800M	TO-220
TIC116M	TO-220	S122M	TO-220	40867	TO-220AB	S2800A	TO-220AB	2N6349	TO-220	T2800N	TO-220
TIC126A	TO-220	2N6395	TO-220	40868	TO-220AB	S2800B	TO-220AB	6T06	TO-66	T2700B	TO-66
TIC126B	TO-220	2N6396	TO-220	40869	TO-220AB	S2800D	TO-220AB	6T08	TO-66	T4700B	TO-66
TIC126C	TO-220	S6000G	TO-220	40888	TO-66	S37035F	TO-66	6T16	TO-66	T2700B	TO-66
TIC126D	TO-220	2N6397	TO-220	40889	TO-66	S3702S	TO-66	6T18	TO-66	T4700B	TO-66
TIC126E	TO-220	S6000E	TO-220	TRIACS							
TIC126F	TO-220	2N6349	TO-220	2N6068	Case 77	T2303F	TO-5	6T26	TO-66	T2700B	TO-66
TIC126M	TO-220	2N6398	TO-220			T2500Q	TO-220	6T28	TO-66	T4700B	TO-66
TY504	TO-220	S2062A	TO-220	2N6068A	Case 77	T2301F	TO-5	6T36	TO-66	T2700D	TO-66
TY1004	TO-220	S2062A	TO-220	2N6068B	Case 77	T2300F	TO-5	6T38	TO-66	T4700D	TO-66
TY2004	TO-220	S2062B	TO-220	2N6069	Case 77	T2303F	TO-5	6T46	TO-66	T2700D	TO-66
TY3004	TO-220	S2062C	TO-220			T2500Y	TO-220	6T48	TO-66	T4700D	TO-66
TY4004	TO-220	S2062D	TO-220	2N6069A	Case 77	T2301F	TO-5	BRY41-100	TO-39	2N5754	TO-39
TY5004	TO-220	S2062E	TO-220	2N6069B	Case 77	T2300F	TO-5	BRY41-200	TO-39	2N5755	TO-39
TY6004	TO-220	S2062M	TO-220	2N6070	Case 77	2N5754	TO-5	BRY41-300	TO-39	2N5756	TO-39
TY507	TO-220	S122A	TO-220			T2500A	TO-220	BRY41-400	TO-39	2N5757	TO-39
TY1007	TO-220	S122A	TO-220	2N6070A	Case 77	T2301A	TO-5	BRY41-500	TO-39	2N5757	TO-39
TY2007	TO-220	S122B	TO-220	2N6070B	Case 77	T2300A	TO-5	BRY45-100	TO-39	2N5754	TO-39
TY3007	TO-220	S122C	TO-220	2N6071	Case 77	2N5755	TO-5	BRY45-200	TO-39	2N5755	TO-39
TY4007	TO-220	S122D	TO-220			T2500B	TO-220	BRY45-300	TO-39	2N5756	TO-39
TY5007	TO-220	S122E	TO-220	2N6071A	Case 77	T2301B	TO-5	BRY45-400	TO-39	2N5757	TO-39
TY6007	TO-220	S122M	TO-220	2N6071B	Case 77	T2300B	TO-5	BRY45-500	TO-39	2N5757	TO-39
TY510	TO-220	S2800F	TO-220	2N6072	Case 77	2N5756	TO-5	BTR0205	TO-66	T2700B	TO-66
TY1010	TO-220	S2800A	TO-220			T2500C	TO-220	BTR0210	TO-66	T2700B	TO-66
TY2010	TO-220	S8200B	TO-220	2N6072A	Case 77	2N5756	TO-5	BTR0220	TO-66	T2700B	TO-66
TY3010	TO-220	S2800C	TO-220	2N6072B	Case 77	T2300D	TO-5	BTR0230	TO-66	T2700D	TO-66
TY4010	TO-220	S2800D	TO-220	2N6073	Case 77	2N5756	TO-5	BTR0240	TO-66	T2700D	TO-66
TY5010	TO-220	S2800E	TO-220			T2500D	TO-220	BTR0305	TO-66	T2700B	TO-66
TY6010	TO-220	S2800M	TO-220	2N6073A	Case 77	T2301D	TO-5	BTR0310	TO-66	T2700B	TO-66
				2N6073B	Case 77	T2300D	TO-5	BTR0320	TO-66	T2700B	TO-66

Power Devices Cross-Reference Guide

(Industry Type to Equivalent RCA Type)

TRIACS (CONT'D)

Industry Type	Package	RCA Type	Package	Industry Type	Package	RCA Type	Package	Industry Type	Package	RCA Type	Package
BTR0330	TO-66	T2700D	TO-66	BTW0405	ISOstud	T4121B	ISOstud	BTX0550	ISOstud	T4120M	ISOstud
BTR0340	TO-66	T2700D	TO-66	BTW0410	ISOstud	T4121B	ISOstud	BTX0560	ISOstud	T4120M	ISOstud
BTR0405	TO-66	T4700B	TO-66	BTW0420	ISOstud	T4121B	ISOstud	BTX0605	ISOstud	T6421B	ISOstud
BTR0410	TO-66	T4700B	TO-66	BTW0430	ISOstud	T4121D	ISOstud	BTX0610	ISOstud	T6421B	ISOstud
BTR0420	TO-66	T4700B	TO-66	BTW0440	ISOstud	T4121D	ISOstud	BTX0620	ISOstud	T6421B	ISOstud
BTR0430	TO-66	T4700D	TO-66	BTW0450	ISOstud	T4121M	ISOstud	BTX0630	ISOstud	T6421D	ISOstud
BTR0440	TO-66	T4700D	TO-66	BTW0460	ISOstud	T4121M	ISOstud	BTX0640	ISOstud	T6421D	ISOstud
BTS0305	press-fit	2N5567	press-fit	BTW10-100	TO-66	T2700B	TO-66	BTX0650	ISOstud	T6421M	ISOstud
BTS0310	press-fit	2N5567	press-fit	BTW10-200	TO-66	T2700B	TO-66	BTX0660	ISOstud	T6421M	ISOstud
BTS0320	press-fit	2N5567	press-fit	BTW10-300	TO-66	T2700D	TO-66	HB26	TO-5	2N5755	TO-5
BTS0330	press-fit	2N5568	press-fit	BTW10-400	TO-66	T2700D	TO-66	HB46	TO-5	2N5756	TO-5
BTS0340	press-fit	2N5568	press-fit	BTW11-100	TO-66	T2700B	TO-66	H103SC	TO-5	T2301F	TO-5
BTS0350	press-fit	T4101M	press-fit	BTW11-200	TO-66	T2700B	TO-66	H103SD	TO-5	T2301A	TO-5
BTS0360	press-fit	T4101M	press-fit	BTW11-300	TO-66	T2700D	TO-66	H103SG	TO-5	T2302F	TO-5
BTS0405	press-fit	2N5567	press-fit	BTW11-400	TO-66	T2700D	TO-66	H103SH	TO-5	T2303F	TO-5
BTS0410	press-fit	2N5567	press-fit	BTW12-100	press-fit	2N5567	press-fit	H103SS	TO-5	T2300F	TO-5
BTS0420	press-fit	2N5567	press-fit	BTW12-200	press-fit	2N5567	press-fit	H113SC	TO-5	T2301A	TO-5
BTS0430	press-fit	2N5568	press-fit	BTW12-300	press-fit	2N5568	press-fit	H113SD	TO-5	T2301A	TO-5
BTS0440	press-fit	2N5568	press-fit	BTW12-400	press-fit	2N5568	press-fit	H113SG	TO-5	T2302A	TO-5
BTS0450	press-fit	T4101M	press-fit	BTW12-500	press-fit	T4101M	press-fit	H113SH	TO-5	2N5754	TO-5
BTS0460	press-fit	T4101M	press-fit	BTW13-100	stud	2N5569	stud	H113SS	TO-5	T2300A	TO-5
BTS0505	press-fit	2N5571	press-fit	BTW13-200	stud	2N5569	stud	H123SC	TO-5	T2301B	TO-5
BTS0510	press-fit	2N5571	press-fit	BTW13-300	stud	2N5570	stud	H123SD	TO-5	T2301B	TO-5
BTS0520	press-fit	2N5571	press-fit	BTW13-400	stud	2N5570	stud	H123SG	TO-5	T2302B	TO-5
BTS0530	press-fit	2N5572	press-fit	BTW13-500	stud	T4111M	stud	H123SH	TO-5	2N5755	TO-5
BTS0540	press-fit	2N5572	press-fit	BTW14-100	TO-66	T4700B	TO-66	H123SS	TO-5	T2300B	TO-5
BTS0550	press-fit	T4100M	press-fit	BTW14-200	TO-66	T4700B	TO-66	H133SC	TO-5	T2301D	TO-5
BTS0560	press-fit	T4100M	press-fit	BTW14-300	TO-66	T4700D	TO-66	H133SD	TO-5	T2301D	TO-5
BTS0605	press-fit	2N5441	press-fit	BTW14-400	TO-66	T4700D	TO-66	H133SG	TO-5	T2302D	TO-5
BTS0610	press-fit	2N5441	press-fit	BTW15-100	press-fit	2N5567	press-fit	H133SH	TO-5	2N5756	TO-5
BTS0620	press-fit	2N5441	press-fit	BTW15-200	press-fit	2N5567	press-fit	H133SS	TO-5	T2300D	TO-5
BTS0630	press-fit	2N5442	press-fit	BTW15-300	press-fit	2N5568	press-fit	H143SC	TO-5	T2301D	TO-5
BTS0640	press-fit	2N5442	press-fit	BTW15-400	press-fit	2N5568	press-fit	H143SD	TO-5	T2301D	TO-5
BTS0650	press-fit	2N5443	press-fit	BTW15-500	press-fit	T4101M	press-fit	H143SG	TO-5	T2302D	TO-5
BTS0660	press-fit	2N5443	press-fit	BTW16-100	stud	2N5569	stud	H143SH	TO-5	2N5756	TO-5
BTU0305	stud	2N5569	stud	BTW16-200	stud	2N5569	stud	H143SS	TO-5	T2300D	TO-5
BTU0310	stud	2N5569	stud	BTW16-300	stud	2N5570	stud	H153SH	TO-5	2N5757	TO-5
BTU0320	stud	2N5569	stud	BTW16-400	stud	2N5570	stud	H163SH	TO-5	2N5757	TO-5
BTU0330	stud	2N5570	stud	BTW16-500	stud	T4111M	stud	IT06	TO-220	T2850A	TO-220
BTU0340	stud	2N5570	stud	BTW18-100	press-fit	2N5571	press-fit	IT08	TO-220	T2850A	TO-220
BTU0350	stud	T4111M	stud	BTW18-200	press-fit	2N5571	press-fit	IT16	TO-220	T2850A	TO-220
BTU0360	stud	T4111M	stud	BTW18-300	press-fit	2N5572	press-fit	IT18	TO-220	T2850A	TO-220
BTU0405	stud	2N5569	stud	BTW18-400	press-fit	2N5572	press-fit	IT26	TO-220	T2850B	TO-220
BTU0410	stud	2N5569	stud	BTW18-500	press-fit	T4101M	press-fit	IT28	TO-220	T2850B	TO-220
BTU0420	stud	2N5569	stud	BTW19-100	press-fit	2N5571	press-fit	IT36	TO-220	T2850D	TO-220
BTU0430	stud	2N5570	stud	BTW19-200	press-fit	2N5571	press-fit	IT38	TO-220	T2850D	TO-220
BTU0440	stud	2N5570	stud	BTW19-300	press-fit	2N5572	press-fit	IT46	TO-220	T2850D	TO-220
BTU0450	stud	T4111M	stud	BTW19-400	press-fit	2N5572	press-fit	IT48	TO-220	T2850D	TO-220
BTU0460	stud	T4111M	stud	BTW19-500	press-fit	T4101M	press-fit	L2001M3	TO-39	T2300B	TO-39
BTU0505	stud	2N5573	stud	BTW20-100	stud	T6411B	stud		low profile		
BTU0510	stud	2N5573	stud	BTW20-200	stud	T6411B	stud	L2001M4	TO-39	T2300B	TO-39
BTU0520	stud	2N5573	stud	BTW20-300	stud	T6411D	stud		low profile		
BTU0530	stud	2N5574	stud	BTW20-400	stud	T6411D	stud	L2001M5	TO-39	T2301B	TO-39
BTU0540	stud	2N5574	stud	BTW20-500	stud	T6411M	stud		low profile		
BTU0550	stud	T4110M	stud	BTX94-400	stud	T6411D	stud	L2001M7	TO-39	T2302B	TO-39
BTU0560	stud	T4110M	stud	BTX94-500	stud	T6411M	stud		low profile		
BTU0605	stud	T6411B	stud	BTX94-600	stud	T6411M	stud	L2001M9	TO-39	2N5755	TO-5
BTU0610	stud	T6411B	stud	BTX0505	ISOstud	T4120B	ISOstud		low profile		
BTU0620	stud	T6411B	stud	BTX0510	ISOstud	T4120B	ISOstud	L4001M3	TO-39	T2300D	TO-39
BTU0630	stud	T6411D	stud	BTX0520	ISOstud	T4120B	ISOstud		low profile		
BTU0640	stud	T6411D	stud	BTX0530	ISOstud	T4120D	ISOstud	L4001M4	TO-39	T2300D	TO-39
BTU0650	stud	T6411M	stud	BTX0540	ISOstud	T4120D	ISOstud		low profile		
BTU0660	stud	T6411M	stud								

Power Devices Cross-Reference Guide

(Industry Type to Equivalent RCA Type)

TRIACS (CONT'D)

Industry Type	RCA Package	Package	Industry Type	RCA Package	Package	Industry Type	RCA Package	Package			
L4001M5	TO-39	T2301D	TO-39	MAC-37-7	press-fit	T6401M	press-fit	PT410	press-fit	2N5568	press-fit
		low profile		MAC-38-1	stud	T6411B	stud	PT415	press-fit	2N5572	press-fit
L4001M7	TO-39	T2302D	TO-39	MAC-38-2	stud	T6411B	stud	PT425	press-fit	T6401D	press-fit
		low profile		MAC-38-3	stud	T6411B	stud	PT430	press-fit	T6401D	press-fit
L4001M9	TO-39	2N5576	TO-5	MAC-38-4	stud	T6411B	stud	PT440	press-fit	2N5442	press-fit
		low profile		MAC-38-5	stud	T6411D	stud	PT510	press-fit	T4101M	press-fit
MAC-1-1	Case 85	2N5567	press-fit	MAC-38-6	stud	T6411D	stud	PT515	press-fit	T4100M	press-fit
MAC-1-2	Case 85	2N5567	press-fit	MAC-38-7	stud	T6411M	stud	PT525	press-fit	T6401M	press-fit
MAC-1-3	Case 85	2N5567	press-fit	MAC92A-1	TO-92	T2301F	TO-5	PT530	press-fit	T6401M	press-fit
MAC-1-4	Case 85	2N5567	press-fit	MAC92A-2	TO-92	T2301A	TO-5	PT540	press-fit	2N5443	press-fit
MAC-1-5	Case 85	2N5568	press-fit	MAC92A-3	TO-92	T2301A	TO-5	PT610	press-fit	T4101M	press-fit
MAC-1-6	Case 85	2N5568	press-fit	MAC92A-4	TO-92	T2301B	TO-5	PT615	press-fit	T4100M	press-fit
MAC-1-7	Case 85	T4101M	press-fit	MAC92A-5	TO-92	T2301D	TO-5	PT625	press-fit	T6401M	press-fit
MAC-1-8	Case 85	T4101M	press-fit	MAC92A-6	TO-92	T2301D	TO-5	PT630	press-fit	T6401M	press-fit
MAC-2-1	Case 86	2N5569	stud	MAC93A-1	TO-92	T2301F	TO-5	Q2001MS2	TO-5	T2302B	TO-5
MAC-2-2	Case 86	2N5569	stud	MAC93A-2	TO-92	T2301A	TO-5	Q2001M2	TO-5	2N5755	TO-5
MAC-2-3	Case 86	2N5569	stud	MAC93A-3	TO-92	T2301A	TO-5	Q2003P	TO-5	T2800B	TO-5
MAC-5-1	stud	2N5569	stud	MAC93A-4	TO-92	T2301B	TO-5	Q2004	ISOstud	T4120B	ISOstud
MAC-5-2	stud	2N5569	stud	MAC94A-1	TO-92	T2301F	TO-5	Q2006L4	ISO	T2850B	ISO
MAC-5-3	stud	2N5569	stud	MAC94A-2	TO-92	T2301A	TO-5		TO-220		TO-220
MAC-5-4	stud	2N5569	stud	MAC94A-3	TO-92	T2301A	TO-5	Q2008	ISOstud	T4121B	ISOstud
MAC-5-5	stud	2N5570	stud	MAC94A 4	TO-92	T2301B	TO-5	Q2010	ISOstud	T4121B	ISOstud
MAC-5-6	stud	2N5570	stud	MAC40688	ISOstud	T6420B	ISOstud	Q2015	ISOstud	T4120B	ISOstud
MAC-5-7	stud	T4111M	stud	MAC40689	ISOstud	T6420D	ISOstud	Q2025	ISOstud	T6421B	ISOstud
MAC-5-8	stud	T4111M	stud	MAC40690	ISOstud	T6420M	ISOstud	Q2040	ISOstud	T6420B	ISOstud
MAC-10-1	Case 90	T2800B	TO-220	MAC40797	press-fit	T4100M	press-fit	Q4001MS2	TO-5	T2302D	TO-5
MAC-10-2	Case 90	T2800B	TO-220	MAC40798	stud	T4110M	stud	Q4001M2	TO-5	2N5756	TO-5
MAC-10-3	Case 90	T2800B	TO-220	PT06	press-fit	2N5567	press-fit	Q4003L4	ISO	T2850D	ISO
MAC-10-4	Case 90	T2800B	TO-220	PT08	press-fit	2N5567	press-fit		TO-220		TO-220
MAC-10-5	Case 90	T2800C	TO-220	PT10	press-fit	2N5567	press-fit	Q4004	ISOstud	T4121D	ISOstud
MAC-10-6	Case 90	T2800D	TO-220	PT15	press-fit	2N5567	press-fit	Q4004L4	ISO	T2850D	ISO
MAC-10-7	Case 90	T2800E	TO-220	PT16	press-fit	2N5567	press-fit		TO-220		TO-220
MAC-10-8	Case 90	T2800M	TO-220	PT18	press-fit	2N5567	press-fit	Q4006	ISOstud	T4121D	ISOstud
MAC-11-1	Case 90	T2802B	TO-220	PTO25	press-fit	T6401B	press-fit	Q4006L4	ISO	T2850D	ISO
MAC-11-2	Case 90	T2802B	TO-220	PTO26	press-fit	2N5867	press-fit		TO-220		TO-220
MAC-11-3	Case 90	T2802B	TO-220	PTO28	press-fit	2N6567	press-fit	Q4008	ISOstud	T4121D	ISOstud
MAC-11-4	Case 90	T2802B	TO-220	PTO30	press-fit	T6401B	press-fit	Q4010	ISOstud	T4121D	ISOstud
MAC-11-5	Case 90	T2802C	TO-220	PTO36	press-fit	2N5568	press-fit	Q4015	ISOstud	T4120D	ISOstud
MAC-11-6	Case 90	T2802D	TO-220	PTO38	press-fit	2N5568	press-fit	Q4025	ISOstud	T6421D	ISOstud
MAC-11-7	Case 90	T2802E	TO-220	PTO40	press-fit	2N5441	press-fit	Q4040	ISOstud	T6420D	ISOstud
MAC-11-8	Case 90	T2802M	TO-220	PTO46	press-fit	2N5568	press-fit	Q5006L4	ISO	T2850D	ISO
MAC-35-1	press-fit	T6401B	press-fit	PTO48	press-fit	2N5568	press-fit		TO-220		TO-220
MAC-35-2	press-fit	T6401B	press-fit	PTO56	press-fit	T4101M	press-fit	Q5008	ISOstud	T4121M	ISOstud
MAC-35-3	press-fit	T6401B	press-fit	PTO58	press-fit	T4101M	press-fit	Q5010	ISOstud	T4121M	ISOstud
MAC-35-4	press-fit	T6401B	press-fit	PTO66	press-fit	T4101M	press-fit	Q4015	ISOstud	T4120M	ISOstud
MAC-35-5	press-fit	T6401D	press-fit	PTO68	press-fit	T4101M	press-fit	Q5025	ISOstud	T6421M	ISOstud
MAC-35-6	press-fit	T6401D	press-fit	PT110	press-fit	2N5567	press-fit	Q5040	ISOstud	T6420M	ISOstud
MAC-35-7	press-fit	T6401M	press-fit	PT115	press-fit	2N5571	press-fit	Q6008	ISOstud	T4121M	ISOstud
MAC-36-1	stud	T6411B	stud	PT125	press-fit	T6401B	press-fit	Q6010	ISOstud	T4121M	ISOstud
MAC-36-2	stud	T6411B	stud	PT130	press-fit	T6401B	press-fit	Q6015	ISOstud	T4120M	ISOstud
MAC-36-3	stud	T6411B	stud	PT140	press-fit	2N5441	press-fit	Q6025	ISOstud	T6421M	ISOstud
MAC-36-4	stud	T6411B	stud	PT210	press-fit	2N5567	press-fit	Q6040	ISOstud	T6420M	ISOstud
MAC-36-5	stud	T6411D	stud	PT215	press-fit	2N5571	press-fit	Q8025	ISOstud	T6420N	ISOstud
MAC-36-6	stud	T6411D	stud	PT225	press-fit	T6401B	press-fit	Q8040	ISOstud	T6420N	ISOstud
MAC-36-7	stud	T6411M	stud	PT230	press-fit	T6401B	press-fit	SC35A	stud	2N5569	stud
MAC-37-1	press-fit	T6401B	press-fit	PT240	press-fit	2N5441	press-fit	SC35B	stud	2N5569	stud
MAC-37-2	press-fit	T6401B	press-fit	PT310	press-fit	2N5568	press-fit	SC35D	stud	2N5570	stud
MAC-37-3	press-fit	T6401B	press-fit	PT315	press-fit	2N5572	press-fit	SC35F	stud	2N5569	stud
MAC-37-4	press-fit	T6401B	press-fit	PT325	press-fit	T6401D	press-fit	SC36A	press-fit	2N5567	press-fit
MAC-37-5	press-fit	T6401D	press-fit	PT330	press-fit	T6401D	press-fit	SC36B	press-fit	2N5567	press-fit
MAC-37-6	press-fit	T6401D	press-fit	PT340	press-fit	2N5442	press-fit	SC36D	press-fit	2N5568	press-fit

Power Devices Cross-Reference Guide (Industry Type to Equivalent RCA Type)

TRIACS (CONT'D)

Industry Type	RCA Package Type	Package	Industry Type	RCA Package Type	Package	Industry Type	RCA Package Type	Package
SC36F	press-fit 2N5567	press-fit stud	SC61B12	press-fit T6401B	press-fit stud	SC245E	stud T4111M	stud
SC40A	stud 2N5569	stud	SC61B13	press-fit T6401B	press-fit stud	SC245E2	ISOstud T4121M	ISOstud
SC40B	stud 2N5569	stud	SC61B14	press-fit T6404B	press-fit stud	SC245E12	stud T4111M	stud
SC40B2	ISOstud T4121B	ISOstud	SC61D	press-fit T6401D	press-fit stud	SC245E13	stud T4111M	stud
SC40D	stud 2N5570	stud	SC61D12	press-fit T6401D	press-fit stud	SC245E22	ISOstud T4121M	ISOstud
SC40D2	ISOstud T4121D	ISOstud	SC61D13	press-fit T6401D	press-fit stud	SC245E23	ISOstud T4121M	ISOstud
SC40E	stud T4111M	stud	SC61D14	press-fit T6404D	press-fit stud	SC246B	press-fit 2N5567	press-fit stud
SC40E2	ISOstud T4121M	ISOstud	SC61E	press-fit T6401M	press-fit stud	SC246B12	press-fit 2N5567	press-fit stud
SC40F	stud 2N5569	stud	SC61E12	press-fit T6401M	press-fit stud	SC246B13	press-fit 2N5567	press-fit stud
SC41A	press-fit 2N5567	press-fit stud	SC61E13	press-fit T6401M	press-fit stud	SC246B14	press-fit T4105B	press-fit stud
SC41B	press-fit 2N5567	press-fit stud	SC136A	TO-202 2N5754	TO-5	SC246D	press-fit 2N5568	press-fit stud
SC41D	press-fit 2N5568	press-fit stud	SC136B	TO-202 2N5755	TO-5	SC246D12	press-fit 2N5568	press-fit stud
SC41E	press-fit T4101M	press-fit stud	SC136D	TO-202 2N5756	TO-5	SC246D13	press-fit 2N5568	press-fit stud
SC41F	press-fit 2N5567	press-fit stud	SC141B	TO-220 T2800B	TO-220	SC246D14	press-fit T4105D	press-fit stud
SC45A	stud 2N5569	stud	SC141D	TO-220 T2800D	TO-220	SC246E	press-fit T4101M	press-fit stud
SC45B	stud 2N5569	stud	SC141E	TO-220 T2800E	TO-220	SC246E12	press-fit T4101M	press-fit stud
SC45B2	ISOstud T4121B	ISOstud	SC141M	TO-220 T2800M	TO-220	SC246E13	press-fit T4101M	press-fit stud
SC45D	stud 2N5570	stud	SC146B	TO-220 T2800B	TO-220	SC250B	stud 2N5573	stud
SC45D2	ISOstud T4121D	ISOstud	SC146D	TO-220 T2800D	TO-220	SC250B2	ISOstud T4120B	ISOstud
SC45E	stud T4111M	stud	SC146E	TO-220 T2800E	TO-220	SC250B12	stud 2N5573	stud
SC45E2	ISOstud T4121M	ISOstud	SC146M	TO-220 T2800M	TO-220	SC250B13	stud 2N5573	stud
SC45F	stud 2N5569	stud	SC240B	stud 2N5569	stud	SC250B14	stud T4113B	stud
SC46A	press-fit 2N5567	press-fit stud	SC240B2	ISOstud T4121B	ISOstud	SC250B22	ISOstud T4120B	ISOstud
SC46B	press-fit 2N5567	press-fit stud	SC240B12	stud 2N5569	stud	SC250D	stud 2N5574	stud
SC46D	press-fit 2N5568	press-fit stud	SC240B13	stud 2N5569	stud	SC250D2	ISOstud T4120D	ISOstud
SC46E	press-fit T4101M	press-fit stud	SC240B22	ISOstud T4121B	ISOstud	SC250D12	stud 2N5574	stud
SC46F	press-fit 2N5567	press-fit stud	SC240B23	ISOstud T4121B	ISOstud	SC250D13	stud 2N5574	stud
SC50A	stud 2N5573	stud	SC240D	stud 2N5570	stud	SC250D14	stud T4113D	stud
SC50B	stud 2N5573	stud	SC240D2	ISOstud T4121D	ISOstud	SC250D22	ISOstud T4120D	ISOstud
SC50B2	ISOstud T4120B	ISOstud	SC240D12	stud 2N5570	stud	SC250E	stud T4110M	stud
SC50D	stud 2N5574	stud	SC240D13	stud 2N5570	stud	SC250E2	ISOstud T4120M	ISOstud
SC50D2	ISOstud T4120D	ISOstud	SC240D22	ISOstud T4121D	ISOstud	SC250E12	stud T4110M	stud
SC50E	stud 2N5573	stud	SC240D23	ISOstud T4121D	ISOstud	SC250E13	stud T4110M	stud
SC50E2	ISOstud T4120M	ISOstud	SC240E	stud T4111M	stud	SC250E22	ISOstud T4120M	ISOstud
SC50F	stud 2N5573	stud	SC240E2	ISOstud T4121M	ISOstud	SC251B	press-fit 2N5571	press-fit stud
SC51A	press-fit 2N5571	press-fit stud	SC240E12	stud T4111M	stud	SC251B12	press-fit 2N5571	press-fit stud
SC51B	press-fit 2N5571	press-fit stud	SC240E13	stud T4111M	stud	SC251B13	press-fit 2N5571	press-fit stud
SC51D	press-fit 2N5572	press-fit stud	SC240E22	ISOstud T4121M	ISOstud	SC251B14	press-fit T4103B	press-fit stud
SC51E	press-fit T4100M	press-fit stud	SC240E23	ISOstud T4121M	ISOstud	SC251D	press-fit 2N5572	press-fit stud
SC51F	press-fit 2N5571	press-fit stud	SC241B	press-fit 2N5567	press-fit stud	SC251D12	press-fit 2N5572	press-fit stud
SC60B	stud T6411B	stud	SC241B12	press-fit 2N5567	press-fit stud	SC251D13	press-fit 2N5572	press-fit stud
SC60B2	ISOstud T6421B	ISOstud	SC241B13	press-fit 2N5567	press-fit stud	SC251D14	press-fit T4103D	press-fit stud
SC60B12	stud T6411B	stud	SC241D	press-fit 2N5568	press-fit stud	SC251E	press-fit T4100M	press-fit stud
SC60B13	stud T6411B	stud	SC241D12	press-fit 2N5568	press-fit stud	SC251E12	press-fit T4100M	press-fit stud
SC60B14	stud T6414B	stud	SC241D13	press-fit 2N5568	press-fit stud	SC251E13	press-fit T4100M	press-fit stud
SC60B22	ISOstud T6421B	ISOstud	SC241E	press-fit T4101M	press-fit stud	SPT06	stud 2N5569	stud
SC60B23	ISOstud T6421B	ISOstud	SC241E12	press-fit T4101M	press-fit stud	SPT08	stud 2N5569	stud
SC60D	stud T6411D	stud	SC241E13	press-fit T4101M	press-fit stud	SPT10	stud 2N5569	stud
SC60D2	ISOstud T6421D	ISOstud	SC245B	stud 2N5569	stud	SPT15	stud 2N5573	stud
SC60D12	stud T6411D	stud	SC245B2	ISOstud T4121B	ISOstud	SPT16	stud 2N5569	stud
SC60D13	stud T6411D	stud	SC245B12	stud 2N5569	stud	SPT18	stud 2N5569	stud
SC60D14	stud T6414D	stud	SC245B13	stud 2N5569	stud	SPT025	stud T6411B	stud
SC60D22	ISOstud T6421D	ISOstud	SC245B14	stud T4115B	stud	SPT030	stud T6411B	stud
SC60D23	ISOstud T6421D	ISOstud	SC245B22	ISOstud T4121B	ISOstud	SPT26	stud 2N5569	stud
SC60E	stud T6411M	stud	SC245B23	ISOstud T4121B	ISOstud	SPT28	stud 2N5569	stud
SC60E2	ISOstud T6421M	ISOstud	SC245D	stud 2N5570	stud	SPT36	stud 2N5570	stud
SC60E12	stud T6411M	stud	SC245D2	ISOstud T4121D	ISOstud	SPT38	stud 2N5570	stud
SC60E13	stud T6411M	stud	SC245D12	stud 2N5570	stud	SPT40	stud 2N5444	stud
SC60E22	ISOstud T6421M	ISOstud	SC245D13	stud 2N5570	stud	SPT46	stud 2N5570	stud
SC60E23	ISOstud T6421M	ISOstud	SC245D14	stud T4115D	stud	SPT48	stud 2N5570	stud
SC61B	press-fit T6401B	press-fit stud	SC245D22	ISOstud T4121D	ISOstud	SPT56	stud T4111M	stud
			SC245D23	ISOstud T4121D	ISOstud	SPT58	stud T4111M	stud

Power Devices Cross-Reference Guide

(Industry Type to Equivalent RCA Type)

TRIACS (CONT'D)

Industry Type	Package	RCA Type	Package	Industry Type	Package	RCA Type	Package	Industry Type	Package	RCA Type	Package
SPT68	stud	T4111M	stud	TA6-224-400	TO-220	T2802D	TO-220	TDAL223B	TO-39	T2302D	TO-39
SPT110	stud	2N5569	stud	TA6-224-600	TO-220	T2802M	TO-220	TDAL113S	TO-39	T2300B	TO-39
SPT115	stud	2N5573	stud	TA6-225-200	TO-220	T2800B	TO-220	TDAL2235	TO-39	T2300D	TO-39
SPT125	stud	T6411B	stud	TA6-225-400	TO-220	T2800D	TO-220	TJAL602D	stud	T8411B	stud
SPT130	stud	T6411B	stud	TA6-225-600	TO-220	T2800M	TO-220	TJAL604D	stud	T8411D	stud
SPT140	stud	2N5444	stud	TA6-240-200	TO-220	T2850B	TO-220	TJAL606D	stud	T8411M	stud
SPT210	stud	2N5569	stud	TA6-240-400	TO-220	T2850D	TO-220	TRAL1110D	TO-48	2N5569	stud
SPT215	stud	2N5573	stud	TA6-241-200	TO-220	T2850D	TO-220	TRAL1115D	TO-48	2N5573	stud
SPT225	stud	T6411B	stud	TA6-245-200	TO-220	T2850B	TO-220	TRAL1125D	TO-48	T6411B	stud
SPT230	stud	T6411B	stud	TA6-245-400	TO-220	T2850D	TO-220	TRAL1130D	ISOstud	T6421B	ISOstud
SPT240	stud	2N5444	stud	TA6-246-200	TO-220	T2850B	TO-220	TRAL1140D	ISOstud	T6420B	ISOstud
SPT310	stud	2N5570	stud	TA6-246-400	TO-220	T2850D	TO-220	TRAL2210D	TO-48	2N5570	stud
SPT315	stud	2N5574	stud	TA6-255-200	TO-220	T6000B	TO-220	TRAL2215D	TO-48	2N5574	stud
SPT325	stud	T6411D	stud	TA6-255-400	TO-220	T6000D	TO-220	TRAL2225D	TO-48	T6411D	stud
SPT330	stud	T6411D	stud	TA6-255-600	TO-220	T6000M	TO-220	TRAL2230D	ISOstud	T6421D	ISOstud
SPT340	stud	2N5445	stud	TA6-255A-200	TO-220	T6000B	TO-220	TRAL2230D	ISOstud	T6421D	ISOstud
SPT410	stud	2N5570	stud	TA6-255A-200	TO-220	T6000D	TO-220	TRAL2240D	ISOstud	T6420D	ISOstud
SPT415	stud	2N5574	stud	TA6-260-200	TO-66	T6000M	TO-220	TX01A10	TO-66	T2700A	TO-66
SPT425	stud	T6411D	stud	TA6-260-400	TO-66	T2700B	TO-66	TXC01A20	TO-66	T2700B	TO-66
SPT430	stud	T6411D	stud	TA6-261-200	TO-66	T2700D	TO-66	TXC01A40	TO-66	T2700D	TO-66
SPT440	stud	2N5445	stud	TA6-261-400	TO-66	T2700B	TO-66	TXC01B10	TO-66	T2700A	TO-66
SPT510	stud	T4111M	stud	TA6-265-200	TO-66	T2700D	TO-66	TXC01B20	TO-66	T2700B	TO-66
SPT515	stud	T4110M	stud	TA6-265-400	TO-66	T4700B	TO-66	TXC01B40	TO-66	T2700D	TO-66
SPT525	stud	T6411M	stud	TA6-266-200	TO-66	T4700D	TO-66	TXC01C10	TO-66	T2700A	TO-66
SPT530	stud	T6411M	stud	TA6-266-400	TO-66	T4700D	TO-66	TXC01C20	TO-66	T2700B	TO-66
SPT540	stud	2N5446	stud	TA6-280-200	TO-220	T6000B	TO-220	TXC01C40	TO-66	T2700D	TO-66
SPT610	stud	T4111M	stud	TA6-280-400	TO-220	T6000D	TO-220	TXC01D10	TO-66	T2700A	TO-66
SPT615	stud	T4110M	stud	TA6-280-600	TO-220	T6000M	TO-220	TXC01D20	TO-66	T2700B	TO-66
SPT625	stud	T6411M	stud	TIC20	press-fit	2N5567	press-fit	TXC01D40	TO-66	T2700D	TO-66
SPT630	stud	T6411M	stud	TIC21	press-fit	2N5568	press-fit	TXC01E10	TO-66	T2700A	TO-66
SPT640	stud	2N5446	stud	TIC22	stud	2N5569	stud	TXC01E20	TO-66	T2700B	TO-66
TA6136	TO-202	T2322D	TO-202	TIC23	stud	2N5570	stud	TXC01E40	TO-66	T2700D	TO-66
TA6-200-100	TO-39	T2302A	TO-39	TIC226B	TO-220	T2800B	TO-220	TXC01F10	TO-66	T2700A	TO-66
TA6-201-100	TO-39	T2303A	TO-39	TIC226D	TO-220	T2800D	TO-220	TXC01F20	TO-66	T2700B	TO-66
TA6-200-200	TO-39	T2302B	TO-39	TIC236B	TO-220	T2800B	TO-220	TXC01F40	TO-66	T2700D	TO-66
TA6-201-200	TO-39	T2303B	TO-39	TIC236D	TO-220	T2800D	TO-220	TXC03A10	MU22	T2500A	TO-220
TA6-200-400	TO-39	T2302D	TO-39	TIC250B	press-fit	T6401B	press-fit	TXC03A20	MU22	T2500B	TO-220
TA6-202-100	TO-39	T2302A	TO-39	TIC250D	press-fit	T6401D	press-fit	TXC03A40	MU22	T2500D	TO-220
TA6-202A-100	TO-39	T2302A	TO-39	TIC250E	press-fit	T6401M	press-fit	TXC03A50	MU22	T2500E	TO-220
TA6-202-200	TO-39	T2302B	TO-39	TIC250M	press-fit	T6401M	press-fit	TXC03B10	MU22	T2500A	TO-220
TA6-202A-200	TO-39	T2302B	TO-39	TIC252B	stud	T6411B	stud	TXC03B20	MU22	T2500B	TO-220
TA6-202-400	TO-39	T2302D	TO-39	TIC252D	stud	T6411D	stud	TXC03B40	MU22	T2500D	TO-220
TA6-202A-400	TO-39	T2302D	TO-39	TIC252E	stud	T6411M	stud	TXC03B50	MU22	T2500E	TO-220
TA6-203-100	TO-39	T2301A	TO-39	TIC252M	stud	T6411M	stud	TXC03C10	MU22	T2500A	TO-220
TA6-203A-100	TO-39	T2301A	TO-39	TIC260B	press-fit	T6401B	press-fit	TXC03C20	MU22	T2500B	TO-220
TA6-203-200	TO-39	T2301B	TO-39	TIC260D	press-fit	T6401D	press-fit	TXC03C40	MU22	T2500D	TO-220
TA6-203A-200	TO-39	T2301B	TO-39	TIC260E	press-fit	T6401M	press-fit	TXC03C50	MU22	T2500E	TO-220
TA6-203-400	TO-39	T2301D	TO-39	TIC260M	press-fit	T6401M	press-fit	TXC03D10	MU22	T2500A	TO-220
TA6-203A-400	TO-39	T2301D	TO-39	TIC262B	stud	T6411B	stud	TXC03D20	MU22	T2500B	TO-220
TA6-204-100	TO-39	T2300A	TO-39	TIC262D	stud	T6411D	stud	TXC03D40	MU22	T2500D	TO-220
TA6-204A-100	TO-39	T2300A	TO-39	TIC262E	stud	T6411M	stud	TXC03D50	MU22	T2500E	TO-220
TA6-204-200	TO-39	T2300B	TO-39	TIC262M	stud	T6411M	stud	TXC03E10	MU22	T2500A	TO-220
TA6-204A-200	TO-39	T2300B	TO-39	TIC270B	press-fit	2N5441	press-fit	TXC03E20	MU22	T2500B	TO-220
TA6-204-400	TO-39	T2300D	TO-39	TIC270D	press-fit	2N5442	press-fit	TXC03E40	MU22	T2500D	TO-220
TA6-204A-400	TO-39	T2300D	TO-39	TIC270E	press-fit	2N5443	press-fit	TXC03E50	MU22	T2500E	TO-220
TA6-205-100	TO-39	T2303A	TO-39	TIC270M	press-fit	2N5443	press-fit	TXC03F10	MU22	T2500A	TO-220
TA205-200	TO-39	T2303B	TO-39	TIC272B	stud	2N5444	stud	TXC03F20	MU22	T2500B	TO-220
TA6-205-400	TO-39	T2303D	TO-39	TIC272D	stud	2N5445	stud	TXC03F40	MU22	T2500D	TO-220
TA6-206-100	TO-39	T2302A	TO-39	TIC272E	stud	2N5446	stud	TXD98A20	stud	2N5573	stud
TA6-206-200	TO-39	T2302B	TO-39	TIC272M	stud	2N5446	stud	TXD98A40	stud	2N5574	stud
TA6-206-400	TO-39	T2302D	TO-39	TDAL113A	TO-39	2N5754	TO-39	TXD98A50	stud	T4110M	stud
TA6-220-200	TO-220	T2500B	TO-220	TDAL223A	TO-39	2N5756	TO-39	TXD99A20	stud	2N5569	stud
TA6-220-400	TO-220	T2500D	TO-220	TDAL113B	TO-39	T2302B	TO-39				
TA6-224-200	TO-220	T2800B	TO-220								

Power Devices Cross-Reference Guide

(Industry Type to Equivalent RCA Type)

TRIACS (CONT'D)

Industry Type	RCA Package Type	Package	Industry Type	RCA Package Type	Package	Industry Type	RCA Package Type	Package			
TXD99A40	stud	2N5570	stud	40663	stud	T6411D	stud	40771	TO-5	T2305B	TO-5
TXD99A50	stud	T4111M	stud	40668	TO-220AB	T2800B	TO-220AB	40772	TO-5	T2305D	TO-5
TXE99A20	stud	T6411B	stud	40669	TO-220AB	T2800D	TO-220AB	40775	press-fit	T4105B	press-fit
TXE99A40	stud	T6411D	stud	40670	TO-220AB	T2800M	TO-220AB	40776	press-fit	T4105D	press-fit
TXE99A50	stud	T6411M	stud	40671	press-fit	T6401M	press-fit	40777	stud	T4115B	stud
TYAL113B	TO-220	T2500B	TO-220	40672	stud	T6411M	stud	40778	stud	T4115D	stud
TYAL113C	TO-220	T2500B	TO-220	40684	TO-5	T2313A	TO-5	40779	press-fit	T4104B	press-fit
TYAL113M	TO-220	T2801B	TO-220	40685	TO-5	T2313B	TO-5	40780	press-fit	T4104D	press-fit
TYAL116B	TO-220	T2500B	TO-220	40686	TO-5	T2313D	TO-5	40781	stud	T4114B	stud
TYAL116C	TO-220	T2500B	TO-220	40687	TO-5	T2313M	TO-5	40782	stud	T4114D	stud
TYAL116M	TO-220	T2801B	TO-220	40688	ISOstud	T6420B	ISOstud	40783	press-fit	T4103B	press-fit
TYAL118B	TO-220	T2800B	TO-220	40689	ISOstud	T6420D	ISOstud	40784	press-fit	T4103D	press-fit
TYAL118C	TO-220	T2800B	TO-220	40690	ISOstud	T6420M	ISOstud	40785	stud	T4113B	stud
TYAL118M	TO-220	T2802B	TO-220	40691	TO-5	T2301B	TO-5	40786	stud	T4113D	stud
TYAL223B	TO-220	T2500D	TO-220	40692	TO-5	T2301D	TO-5	40787	press-fit	T6405B	press-fit
TYAL223C	TO-220	T2500D	TO-220	40693	TO-5	T2316A	TO-5	40788	press-fit	T6405D	press-fit
TYAL223M	TO-220	T2801D	TO-220	40694	TO-5	T2316B	TO-5	40789	stud	T6415B	stud
TYAL226B	TO-220	T2500D	TO-220	40695	TO-5	T2316D	TO-5	40790	stud	T6415D	stud
TYAL226C	TO-220	T2500D	TO-220	40696	TO-5	T2306A	TO-5	40791	press-fit	T6404D	press-fit
TYAL226M	TO-220	T2801D	TO-220	40697	TO-5	T2306B	TO-5	40793	stud	T6414B	stud
TYAL228B	TO-220	T2800D	TO-220	40698	TO-5	T2306D	TO-5	40794	stud	T6414D	stud
TYAL228C	TO-220	T2800D	TO-220	40699	press-fit	T6406B	press-fit	40795	press-fit	T4101M	press-fit
TYAL228M	TO-220	T2802D	TO-220	40700	press-fit	T6406D	press-fit	40796	stud	T4111M	stud
TYAL1110C	TO-220	T2800B	TO-220	40701	press-fit	T6406M	press-fit	40797	press-fit	T4100M	press-fit
TYAL1110C	TO-220	T2800B	TO-220	40702	stud	T6416B	stud	40798	stud	T4110M	stud
TYAL1110M	TO-220	T2802B	TO-220	40703	stud	T6416D	stud	40799	ISOstud	T4121B	ISOstud
TYAL1110M	TO-220	T2802B	TO-220	40704	stud	T6416M	stud	40800	ISOstud	T4121D	ISOstud
TYAL2210B	TO-220	T2800D	TO-220	40705	press-fit	T6407M	press-fit	40801	ISOstud	T4121M	ISOstud
TYAL2210C	TO-220	T2800D	TO-220	40706	press-fit	T6407D	press-fit	40802	ISOstud	T4120B	ISOstud
TYAL2210M	TO-220	T2802D	TO-220	40709	press-fit	T6407M	press-fit	40803	ISOstud	T4120D	ISOstud
40429	TO-66	T2700B	TO-66	40711	press fit	T4106B	press-fit	40804	ISOstud	T4120M	ISOstud
40430	TO-66	T2700D	TO-66	40712	press-fit	T4106D	press-fit	40805	ISOstud	T6421B	ISOstud
40502	TO-66	T2710B	TO-66	40713	stud	T4116B	stud	40806	ISOstud	T6421D	ISOstud
40503	TO-66	T2710D	TO-66	40714	stud	T4116D	stud	40807	ISOstud	T6421M	ISOstud
40525	TO-5	T2300A	TO-5	40715	TO-66	T4706B	TO-66	40900	TO-220AB	T2850A	TO-220AB
40526	TO-5	T2300B	TO-5	40716	TO-66	T4706D	TO-66	40901	TO-220AB	T2850B	TO-220AB
40527	TO-5	T2300D	TO-5	40717	press-fit	T4107B	press-fit	40902	TO-220AB	T2850D	TO-220AB
40528	TO-5	T2302A	TO-5	40718	press-fit	T4107D	press-fit	40927	ISOstud	T6420N	ISOstud
40529	TO-5	T2302B	TO-5	40719	stud	T4117B	stud	41014	TO-220AB	T2500B	TO-220AB
40530	TO-5	T2302D	TO-5	40720	stud	T4117D	stud	41015	TO-220AB	T2500D	TO-220AB
40531	TO-5	T2310A	TO-5	40721	TO-220AB	T2806B	TO-220AB				
40532	TO-5	T2310B	TO-5	40722	TO-220AB	T2806D	TO-220AB				
40533	TO-5	T2310D	TO-5	40727	TO-66	T2706B	TO-66				
40534	TO-5	T2312A	TO-5	40728	TO-66	T2706D	TO-66				
40535	TO-5	T2312B	TO-5	40729	TO-66	T2716B	TO-66				
40536	TO-5	T2312D	TO-5	40730	TO-66	T2716D	TO-66				
40575	TO-66	T4700B	TO-66	40761	TO-5	T2311B	TO-5				
40576	TO-66	T4700D	TO-66	40762	TO-5	T2311D	TO-5				
40660	press-fit	T6401B	press-fit	40766	TO-5	T2301A	TO-5				
40661	press-fit	T6401D	press-fit	40767	TO-5	T2311A	TO-5				
40662	stud	T6411B	stud	40769	TO-5	T2304B	TO-5				
				40770	TO-5	T2304D	TO-5				

Operating Considerations

Solid state devices are being designed into an increasing variety of electronic equipment because of their high standards of reliability and performance. However, it is essential that equipment designers be mindful of good engineering practices in the use of these devices to achieve the desired performance.

This Note summarizes important operating recommendations and precautions which should be followed in the interest of maintaining the high standards of performance of solid state devices.

The ratings included in RCA Solid State Devices data bulletins are based on the Absolute Maximum Rating System, which is defined by the following Industry Standard (JEDEC) statement:

Absolute-Maximum Ratings are limiting values of operating and environmental conditions applicable to any electron device of a specified type as defined by its published data, and should not be exceeded under the worst probable conditions.

The device manufacturer chooses these values to provide acceptable serviceability of the device, taking no responsibility for equipment variations, environmental variations, and the effects of changes in operating conditions due to variations in device characteristics.

The equipment manufacturer should design so that initially and throughout life no absolute-maximum value for the intended service is exceeded with any device under the worst probable operating conditions with respect to supply-voltage variation, equipment component variation, equipment control adjustment, load variation, signal variation, environmental conditions, and variations in device characteristics.

It is recommended that equipment manufacturers consult RCA whenever device applications involve unusual electrical, mechanical or environmental operating conditions.

GENERAL CONSIDERATIONS

The design flexibility provided by these devices makes possible their use in a broad range of applications and under many different operating conditions. When incorporating these devices in equipment, therefore, designers should anticipate the rare possibility of device failure and make certain that no safety hazard would result from such an occurrence.

The small size of most solid state products provides obvious advantages to the designers of electronic equipment. However, it should be recognized that these compact devices usually provide only relatively small insulation area between adjacent leads and the metal envelope. When these devices are used in moist or contaminated atmospheres, therefore, supplemental protection must be provided to prevent the development of electrical conductive paths across the relatively small insulating surfaces. For specific information on voltage creepage, the user should consult references such as the JEDEC Standard No. 7 "Suggested Standard on

Thyristors." and JEDEC Standard RS282 "Standards for Silicon Rectifier Diodes and Stacks".

The metal shells of some solid state devices operate at the collector voltage and for some rectifiers and thyristors at the anode voltage. Therefore, consideration should be given to the possibility of shock hazard if the shells are to operate at voltages appreciably above or below ground potential. In general, in any application in which devices are operated at voltages which may be dangerous to personnel, suitable precautionary measures should be taken to prevent direct contact with these devices.

Devices should not be connected into or disconnected from circuits with the power on because high transient voltages may cause permanent damage to the devices.

TESTING PRECAUTIONS

In common with many electronic components, solid-state devices should be operated and tested in circuits which have reasonable values of current limiting resistance, or other forms of effective current overload protection. Failure to observe these precautions can cause excessive internal heating of the device resulting in destruction and/or possible shattering of the enclosure.

TRANSISTORS AND THYRISTORS WITH FLEXIBLE LEADS

Flexible leads are usually soldered to the circuit elements. It is desirable in all soldering operations to provide some slack or an expansion elbow in each lead to prevent excessive tension on the leads. It is important during the soldering operation to avoid excessive heat in order to prevent possible damage to the devices. Some of the heat can be absorbed if the flexible lead of the device is grasped between the case and the soldering point with a pair of pliers.

TRANSISTORS AND THYRISTORS WITH MOUNTING FLANGES

The mounting flanges of JEDEC-type packages such as the TO-3 or TO-66 often serve as the collector or anode terminal. In such cases, it is essential that the mounting flange be securely fastened to the heat sink, which may be the equipment chassis. Under no circumstances, however, should the mounting flange of a transistor be soldered directly to the heat sink or chassis because the heat of the soldering operation could permanently damage the device. Soldering is the preferred method for mounting thyristors; see "Rectifiers and Thyristors." below. Devices which cannot be soldered can be installed in commercially available sockets. Electrical connections may also be made by soldering directly to the terminal pins. Such connections may be soldered to the pins close to the pin seals provided care is taken to conduct excessive heat away from the seals; otherwise the heat of the soldering operation could crack the pin seals and damage the device.

Operating Considerations

During operation, the mounting-flange temperature is higher than the ambient temperature by an amount which depends on the heat sink used. The heat sink must have sufficient thermal capacity to assure that the heat dissipated in the heat sink itself does not raise the device mounting-flange temperature above the rated value. The heat sink or chassis may be connected to either the positive or negative supply.

In many applications the chassis is connected to the voltage-supply terminal. If the recommended mounting hardware shown in the data bulletin for the specific solid-state device is not available, it is necessary to use either an anodized aluminum insulator having high thermal conductivity or a mica insulator between the mounting-flange and the chassis. If an insulating aluminum washer is required, it should be drilled or punched to provide the two mounting holes for the terminal pins. The burrs should then be removed from the washer and the washer anodized. To insure that the anodized insulating layer is not destroyed during mounting, it is necessary to remove the burrs from the holes in the chassis.

It is also important that an insulating bushing, such as glass-filled nylon, be used between each mounting bolt and the chassis to prevent a short circuit. However, the insulating bushing should not exhibit shrinkage or softening under the operating temperatures encountered. Otherwise the thermal resistance at the interface between device and heat sink may increase as a result of decreasing pressure.

PLASTIC POWER TRANSISTORS AND THYRISTORS

RCA power transistors and thyristors (SCR's and triacs) in molded-silicone-plastic packages are available in a wide range of power-dissipation ratings and a variety of package configurations. The following paragraphs provide guidelines for handling and mounting of these plastic-package devices, recommend forming of leads to meet specific mounting requirements, and describe various mounting arrangements, thermal considerations, and cleaning methods. This information is intended to augment the data on electrical characteristics, safe operating area, and performance capabilities in the technical bulletin for each type of plastic-package transistor or thyristor.

Lead-Forming Techniques

The leads of the RCA VERSAWATT in-line plastic packages can be formed to a custom shape, provided they are not indiscriminately twisted or bent. Although these leads can be formed, they are not flexible in the general sense, nor are they sufficiently rigid for unrestrained wire wrapping.

Before an attempt is made to form the leads of an in-line package to meet the requirements of a specific application, the desired lead configuration should be determined, and a lead-bending fixture should be designed and constructed. The use of a properly designed fixture for this operation eliminates the need for repeated lead bending. When the use of a special bending fixture is not practical, a pair of

long-nosed pliers may be used. The pliers should hold the lead firmly between the bending point and the case, but should not touch the case.

When the leads of an in-line plastic package are to be formed, whether by use of long-nosed pliers or a special bending fixture, the following precautions must be observed to avoid internal damage to the device:

1. Restrain the lead between the bending point and the plastic case to prevent relative movement between the lead and the case.
2. When the bend is made in the plane of the lead (spreading), bend only the narrow part of the lead.
3. When the bend is made in the plane perpendicular to that of the leads, make the bend at least 1/8 inch from the plastic case.
4. Do not use a lead-bend radius of less than 1/16 inch.
5. Avoid repeated bending of leads.

The leads of the TO-220AB VERSAWATT in-line package are not designed to withstand excessive axial pull. Force in this direction greater than 4 pounds may result in permanent damage to the device. If the mounting arrangement tends to impose axial stress on the leads, some method of strain relief should be devised.

Wire wrapping of the leads is permissible, provided that the lead is restrained between the plastic case and the point of the wrapping. Soldering to the leads is also allowed. The maximum soldering temperature, however, must not exceed 275°C and must be applied for not more than 5 seconds at a distance not less than 1/8 inch from the plastic case. When wires are used for connections, care should be exercised to assure that movement of the wire does not cause movement of the lead at the lead-to-plastic junctions.

The leads of RCA molded-plastic high-power packages are not designed to be reshaped. However, simple bending of the leads is permitted to change them from a standard vertical to a standard horizontal configuration, or conversely. Bending of the leads in this manner is restricted to three 90-degree bends; repeated bendings should be avoided.

Mounting

Recommended mounting arrangements and suggested hardware for the VERSAWATT package are given in the data bulletins for specific devices and in RCA Application Note AN-4142.* When the package is fastened to a heat sink, a rectangular washer (RCA Part No. NR231A) is recommended to minimize distortion of the mounting flange. Excessive distortion of the flange could cause damage to the package. The washer is particularly important when the size of the mounting hole exceeds 0.140 inch (6-32 clearance). Larger holes are needed to accommodate insulating bushings; however, the holes should not be larger than necessary to provide hardware clearance and, in any case, should not exceed a diameter of 0.250 inch.

*This Note is included in the Appendix to this DATABOOK.

Operating Considerations

Flange distortion is also possible if excessive torque is used during mounting. A maximum torque of 8 inch-pounds is specified. Care should be exercised to assure that the tool used to drive the mounting screw never comes in contact with the plastic body during the driving operation. Such contact can result in damage to the plastic body and internal device connections. An excellent method of avoiding this problem is to use a spacer or combination spacer-isolating bushing which raises the screw head or nut above the top surface of the plastic body. The material used for such a spacer or spacer-isolating bushing should, of course, be carefully selected to avoid "cold flow" and consequent reduction in mounting force. Suggested materials for these bushings are diallphthalate, fiberglass-filled nylon, or fiberglass-filled polycarbonate. Unfilled nylon should be avoided.

Modification of the flange can also result in flange distortion and should not be attempted. The package should not be soldered to the heat sink by use of lead-tin solder because the heat required with this type of solder will cause the junction temperature of the device to become excessively high.

The TO-220AA plastic package can be mounted in commercially available TO-66 sockets, such as UID Electronics Corp. Socket No. PTS-4 or equivalent. For testing purposes, the TO-220AB in-line package can be mounted in a Jetron Socket No. DC74-104 or equivalent. Regardless of the mounting method, the following precautions should be taken:

1. Use appropriate hardware.
2. Always fasten the package to the heat sink before the leads are soldered to fixed terminals.
3. Never allow the mounting tool to come in contact with the plastic case.
4. Never exceed a torque of 8 inch-pounds.
5. Avoid oversize mounting holes.
6. Provide strain relief if there is any probability that axial stress will be applied to the leads.
7. Use insulating bushings to prevent hot-creep problems. Such bushings should be made of diallphthalate, fiberglass-filled nylon, or fiberglass-filled polycarbonate.

The maximum allowable power dissipation in a solid state device is limited by the junction temperature. An important factor in assuring that the junction temperature remains below the specified maximum value is the ability of the associated thermal circuit to conduct heat away from the device.

When a solid state device is operated in free air, without a heat sink, the steady-state thermal circuit is defined by the junction-to-free-air thermal resistance given in the published data for the device. Thermal considerations require that a free flow of air around the device is always present and that

the power dissipation be maintained below the level which would cause the junction temperature to rise above the maximum rating. However, when the device is mounted on a heat sink, care must be taken to assure that all portions of the thermal circuit are considered.

To assure efficient heat transfer from case to heat sink when mounting RCA molded-plastic solid state power devices, the following special precautions should be observed:

1. Mounting torque should be between 4 and 8 inch-pounds.
2. The mounting holes should be kept as small as possible.
3. Holes should be drilled or punched clean with no burrs or ridges, and chamfered to a maximum radius of 0.010 inch.
4. The mounting surface should be flat within 0.002 inch/inch.
5. Thermal grease (Dow Corning 340 or equivalent) should always be used on both sides of the insulating washer if one is employed. The bleed rate of the thermal-grease compound should be such that it does not exceed 0.5 per cent after 24 hours at 200°C.
6. Thin insulating washers should be used. (Thickness of factory-supplied mica washers range from 2 to 4 mils).
7. A lock washer or torque washer, made of material having sufficient creep strength, should be used to prevent degradation of heat sink efficiency during life.

A wide variety of solvents is available for degreasing and flux removal. The usual practice is to submerge components in a solvent bath for a specified time. However, from a reliability stand point it is extremely important that the solvent, together with other chemicals in the solder-cleaning system (such as flux and solder covers), do not adversely affect the life of the component. This consideration applies to all non-hermetic and molded-plastic components.

It is, of course, impractical to evaluate the effect on long-term device life of all cleaning solvents, which are marketed with numerous additives under a variety of brand names. These solvents can, however, be classified with respect to their component parts as either acceptable or unacceptable. Chlorinated solvents tend to dissolve the outer package and, therefore, make operation in a humid atmosphere unreliable. Gasoline and other hydrocarbons cause the inner encapsulant to swell and damage the transistor. Alcohol is an acceptable solvent. Examples of specific, acceptable alcohols are isopropanol, methanol, and special denatured alcohols, such as SDA1, SDA30, SDA34, and SDA44.

Under certain conditions, dimethyl silicone fluids may react chemically with the encapsulant of plastic devices and cause damage to the package. These fluids do not cause damage when they are contained in materials such as thermal compounds. These fluids, however, are unacceptable for use

Operating Considerations

as baths or encapsulants for plastic-package devices. In addition, plastic-package devices should not be used or stored in environments that contain significant amounts of dimethyl silicone fluid.

Care must also be used in the selection of fluxes for lead soldering. Rosin or activated rosin fluxes are recommended, while organic or acid fluxes are not. Examples of acceptable fluxes are:

1. Alpha Reliaros No. 320-33
2. Alpha Reliaros No. 346
3. Alpha Reliaros No. 711
4. Alpha Reliafoam No. 807
5. Alpha Reliafoam No. 809
6. Alpha Reliafoam No. 811-13
7. Alpha Reliafoam No. 815-35
8. Kester No. 44

If the completed assembly is to be encapsulated, the effect on the molded-plastic transistor must be studied from both a chemical and a physical standpoint.

RECTIFIERS AND THYRISTORS

A surge-limiting impedance should always be used in series with silicon rectifiers and thyristors. The impedance value must be sufficient to limit the surge current to the value specified under the maximum ratings. This impedance may be provided by the power transformer winding, or by an external resistor or choke.

A very efficient method for mounting thyristors utilizing the "modified TO-5" package is to provide intimate contact between the heat sink and at least one half of the base of the device opposite the leads. This package can be mounted to the heat sink mechanically with glue or an epoxy adhesive, or by soldering, the most efficient method.

The use of a "self-jigging" arrangement and a solder preform is recommended. If each unit is soldered individually, the heat source should be held on the heat sink and the solder on the unit. Heat should be applied only long enough to permit solder to flow freely. For more detailed thyristor mounting considerations, refer to Application Note AN3822, "Thermal Considerations in Mounting of RCA Thyristors".

RF POWER TRANSISTORS

Mounting and Handling

Stripline rf devices should be mounted so that the leads are not bent or pulled away from the stud (heat sink) side of the device. When leads are formed, they should be supported to avoid transmitting the bending or cutting stress to the ceramic portion of the device. Excessive stresses may destroy the hermeticity of the package without displaying visible damage.

Devices employing silver leads are susceptible to tarnishing; these parts should not be removed from the

original tarnish-preventive containers and wrappings until ready for use. Lead solderability is retarded by the presence of silver tarnish; the tarnish can be removed with a silver cleaning solution, such as thiourea.

The ceramic bodies of many rf devices contain beryllium oxide as a major ingredient. These portions of the transistors should not be crushed, ground, or abraded in any way because the dust created could be hazardous if inhaled.

Operating

Forward-Biased Operation. For Class A or AB operation, the allowable quiescent bias point is determined by reference to the infrared safe-area curve in the appropriate data bulletin. This curve depicts the safe current/voltage combinations for extended continuous operation.

Load VSWR. Excessive collector load or tuning mismatch can cause device destruction by over-dissipation or secondary breakdown. Mismatch capability is generally included on the data bulletins for the more recent rf transistors.

See RCA RF Power Transistor Manual, Technical Series RMF-430, pp 39-41, for additional information concerning the handling and mounting of rf power transistors.

SOLID STATE CHIPS

Solid state chips, unlike packaged devices, are non-hermetic devices, normally fragile and small in physical size, and therefore, require special handling considerations as follows:

1. Chips must be stored under proper conditions to insure that they are not subjected to a moist and/or contaminated atmosphere that could alter their electrical, physical, or mechanical characteristics. After the shipping container is opened, the chip must be stored under the following conditions:
 - A. Storage temperature, 40°C max.
 - B. Relative humidity, 50% max.
 - C. Clean, dust-free environment.
2. The user must exercise proper care when handling chips to prevent even the slightest physical damage to the chip.
3. During mounting and lead bonding of chips the user must use proper assembly techniques to obtain proper electrical, thermal, and mechanical performance.
4. After the chip has been mounted and bonded, any necessary procedure must be followed by the user to insure that these non-hermetic chips are not subjected to moist or contaminated atmosphere which might cause the development of electrical conductive paths across the relatively small insulating surfaces. In addition, proper consideration must be given to the protection of these devices from other harmful environments which could conceivably adversely affect their proper performance.

Terms and Symbols

General

AQL	acceptance quality level	C_{ib}	common-base input capacitance	I_C	continuous collector current
CM	cross modulation	C_{ob}	common-base output capacitance	I_{CBO}	collector-cutoff current, emitter open
IMD	intermodulation distortion	C_{obo}	open-circuit common-base output capacitance	I_{CEO}	collector-cutoff current, base open
K	post-radiation neutron-damage constant	$E_{S/b}$	reverse-bias second-break-down energy	I_{CER}	collector-cutoff current with specified resistance between base and emitter
LTPD	lot tolerance per cent defective	f_{ab}	base (alpha) cutoff frequency	I_{CES}	collector-cutoff current with base-emitter junction short-circuited
MTBF	mean time between failures	f_{ae}	emitter (beta) cutoff frequency	I_{CEV}	collector-cutoff current with specified voltage between base and emitter
MTTF	mean time to failure	h_{FE}	dc forward-current transfer ratio	I_{CEX}	collector-cutoff current with specified circuit between base and emitter
NF	noise factor (or noise figure)	h_{fe}	common-emitter, small-signal, short-circuit, forward-current transfer ratio	I_{CM}	peak collector current
P_D	device dissipation	$ h_{fe} $	magnitude of common-emitter, small-signal, short-circuit, forward-current transfer ratio	$I_{C(sat)}$	collector current at which h_{FE} , $V_{BE(sat)}$, $V_{CE(sat)}$, and switching speeds are measured
pps	pulses per second	f_{hfe}	common-emitter, small-signal, short-circuit forward-current transfer ratio cutoff frequency	I_E	continuous emitter current
P_{rr}	pulse repetition rate	f_T	gain-bandwidth product (unity-gain frequency for devices in which gain roll off has a -1 slope)	I_{EBO}	emitter-cutoff current, collector open
prt	pulse recurrence time	G_c	conversion gain	I_{EM}	peak emitter current
PW	pulse width	G_{pb}	small-signal, common-base power gain	$I_{S/b}$	forward-bias, second-break-down collector current
RMS	root mean square	G_{PB}	large-signal, common-base power gain	P_G	power gain
$R_{\theta JA}$	thermal resistance, junction-to-ambient	G_{pe}	small-signal, common-emitter power gain	PRT	power rating test
$R_{\theta JC}$	thermal resistance, junction-to-case	G_{PE}	large-signal, common-emitter power gain	P_T	transistor dissipation at specified temperature
$R_{\theta JF}$	thermal resistance, junction-to-flange	G_{VE}	wide-band voltage gain	$r_{bb'}$	base spreading resistance
$R_{\theta JFA}$	thermal resistance, junction-to-free air	h_{ib}	common-base, small-signal, short-circuit input impedance	R_{BB}	base bias resistor
$R_{\theta JHS}$	thermal resistance, junction-to-heat sink	h_{ie}	common-emitter, small-signal, short-circuit input impedance	$r_b' C_C$	collector-to-base time constant
T_A	ambient temperature	h_{ob}	common-base, small-signal, open circuit output admittance	R_{BE}	external base-to-emitter resistance
T_C	case temperature	h_{rb}	common-base, small-signal, open-circuit reverse-voltage transfer ratio	R_C	collector resistor
THD	total harmonic distortion	I_B	continuous base current	$r_{CE(sat)}$	dc collector-to-emitter saturation resistance
T_J	operating (junction) temperature	I_{BEV}	base-cutoff current with specified voltage between collector and emitter	$Re(h_{ie})$	real part of common-emitter, small-signal, short-circuit input impedance
T_L	lead temperature during soldering	I_{BM}	peak base current	R_s	collector-to-emitter saturation resistance
t_p	pulse duration			t_c	clamped turn-off switching time of an inductive load
T_{stg}	storage temperature			t_d	delay time
η	efficiency			t_f	fall time
θ	conduction angle			t_{OFF}	turn-off time (storage time + fall time)
ϕ	phase angle			t_{ON}	turn-on time (delay time + rise time)
ϕ_L	lead radius (for bending)			t_r	rise time
τ	torque			t_s	storage time
τ_s	device stud torque				

Power Transistors

(C)	collector-to-base charge-generation constant (during gamma exposure)
$C_b'c$	feedback capacitance
C_c	collector-to-case capacitance
C_{cb}	collector-to-base feedback capacitance

Terms and Symbols

Power Transistors (Cont'd)

T_{VI}	clamped inductive turn-off time
V_{BB}	base supply voltage
V_{BE}	base-to-emitter voltage
$V_{BE(sat)}$	base-to-emitter saturation voltage
$V_{(BR)CBO}$	collector-to-base breakdown voltage, emitter open
$V_{(BR)CEO}$	collector-to-emitter breakdown voltage, base open
$V_{(BR)CEV}$	collector-to-emitter breakdown voltage with specified voltage between base and emitter
$V_{(BR)CEX}$	collector-to-emitter breakdown voltage with specified circuit between base and emitter
$V_{(BR)EBO}$	emitter-to-base breakdown voltage, collector open
V_{CB}	collector-to-base voltage
V_{CBO}	collector-to-base voltage, emitter open
V_{CC}	collector supply voltage
V_{CE}	collector-to-emitter voltage
V_{CEO}	collector-to-emitter voltage, base open
$V_{CE(sat)}$	collector-to-emitter saturation voltage
$V_{CEO(sus)}$	collector-to-emitter sustaining voltage, base open
V_{CER}	collector-to-emitter voltage with specified resistance between base and emitter
$V_{CER(sus)}$	collector-to-emitter sustaining voltage with specified resistance between base and emitter
V_{CES}	collector-to-emitter voltage with base-emitter junction short-circuited
V_{CEV}	collector-to-emitter voltage with specified voltage between base and emitter
$V_{CEV(sus)}$	collector-to-emitter sustaining voltage with specified voltage between base and emitter
V_{CEX}	collector-to-emitter voltage with specified circuit between base and emitter
$V_{CEX(sus)}$	collector-to-emitter sustaining voltage with specified circuit between base and emitter
V_{EB}	emitter-to-base voltage

V_{EBO}	emitter-to-base voltage, collector open
V_F	diode forward-voltage drop
V_{RT}	collector-to-emitter reach-through (or punch through) voltage
α	common-base current gain (alpha)
β	collector-emitter current gain (beta)
η_C	collector efficiency
τ_I	thermal time constant

Power Hybrid Operational Amplifiers

A	voltage gain
A_{CL}	closed-loop voltage gain
A_{OL}	open-loop voltage gain
$CMRR$	common-mode rejection ratio
f_H	closed-loop bandwidth
I_i	idling current
I_{IB}	input bias current
I_{IO}	input offset current
I_o	quiescent current
I_{om}	maximum peak quiescent current
I_S	short-circuit current
P_T	total power dissipation for each output transistor
R_{em}	common-mode input impedance
S/N	signal-to-noise ratio
SR	slew rate
V_{ICR}	common-mode input voltage range
V_{IN}	input signal voltage swing
V_{IO}	input offset voltage
V_{offset}	offset voltage
V_{OUT}	output voltage swing
V_{OUT}/V_{IN}	voltage gain
V_{RR}	supply-voltage ripple rejection ratio
V_S	supply voltage
Z_{IN}	input impedance
ΔI_i	idling-current drift

Silicon Rectifiers

I_F	forward current
$I_{F(AV)}$	average forward current
$I_{F(RMS)}$	rms forward current
I_{FM}	maximum (peak) forward current
I_{FRM}	repetitive peak forward current

I_{FSM}	peak surge (nonrepetitive) forward current
I_o	average forward current, 180-degree conduction angle, half-sine wave
I_R	reverse current
$I_{R(AV)}$	average dynamic reverse current, single-phase, full-cycle
I_{RM}	maximum (peak) reverse current
I_{rr}	reverse recovery current
I^2t	amperes squared-seconds (fusing current for rectifier protection)
P_F	forward power dissipation
$P_{F(AV)}$	average forward power dissipation
P_{FM}	maximum (peak) forward power dissipation
P_R	reverse power dissipation
R_s	surge-limiting resistance
t_{rr}	reverse recovery time
V_F	forward voltage drop
v_F	instantaneous forward voltage drop
V_R	reverse (dc blocking) voltage
$V_{R(RMS)}$	RMS reverse voltage
V_{RRM}	repetitive peak reverse voltage
V_{RSM}	nonrepetitive peak reverse voltage
V_{RWM}	working peak reverse voltage

Thyristors

(Triacs, SCR's, GTO's, and ITR's) and Diacs

di/dt	rate of change of on-state current
di_F/dt	rate of change of forward current (rectifier unit of ITR)
dv/dt	critical rate of rise of off-state voltage
$I_{(BO)}$	peak breakover current
i_D	instantaneous off-state current
i_{DO}	instantaneous off-state current, gate open
I_{DOM}	maximum (peak) off-state current, gate open
I_{DROM}	maximum peak (repetitive) off-state current, gate open
I_{DRX}	dc off-state current, specified circuit between gate and cathode

Terms and Symbols

Thyristors

(Triacs, SCR's, GTO's, and ITR's and Diacs) (Cont'd)

I_{DRXM}	maximum (peak) repetitive dc off-state current with specified circuit between gate and cathode	I_{TM}	maximum (peak) on-state current	V_{DX}	instantaneous off-state voltage, specified circuit between gate and cathode
I_{DXM}	maximum (peak) off-state current, specified circuit between gate and cathode	$I_{TM(pulse)}$	maximum (peak) pulse on-state current	V_{DX}	dc off-state voltage, specified circuit between gate and cathode
I_F	instantaneous forward current	$I_{T(RMS)}$	rms on-state current	V_F	instantaneous forward voltage drop
I_{FM}	peak forward current	I_{TRXM}	maximum (peak) (repetitive) on-state current, specified operating circuit	V_{FM}	maximum (peak) forward voltage
I_{FRM}	peak repetitive forward current	I_{TSM}	maximum (peak) surge (non-repetitive) on-state current	V_G	dc gate voltage
I_{FSM}	peak surge forward current (nonrepetitive)	I_{TXM}	maximum (peak) on-state current, specified operating circuit	V_{GK}	dc gate-to-cathode voltage
I_G	dc gate current	P_D	device dissipation	V_{gq}	gate turn-off voltage
I_g	pulsed gate trigger current (gate drive current)	$P_{D(AV)}$	average device dissipation	V_{GR}	dc reverse gate voltage
I_{ggM}	maximum gate turn-off current	$P_{G(AV)}$	average gate power dissipation	$V_{GR(BR)}$	reverse gate breakdown voltage
I_{GM}	maximum (peak) gate current	P_{GM}	maximum (peak) gate power dissipation	V_{GRM}	maximum (peak) gate reverse voltage
$I_{GR(BR)}$	reverse gate breakdown current	P_{GRM}	maximum (peak) reverse gate power	V_{GRRM}	Maximum (peak) repetitive reverse gate voltage
I_{GRRM}	maximum (peak) reverse gate current	P_T	on-state power dissipation	V_{GT}	dc gate trigger voltage
I_{GT}	dc gate trigger current	$P_{T(AV)}$	average on-state power dissipation	V_R	dc reverse voltage
I_{HO}	instantaneous holding current, gate open	t_d	delay time	V_{RROM}	maximum (peak) (repetitive) reverse voltage, gate open
I_{HO}	dc holding current, gate open	t_f	fall time	V_{RRXM}	maximum (peak) (repetitive) voltage, specified circuit between gate and cathode
i_L	instantaneous latching current	t_{gq}	gate controlled turn-off time ($t_s + t_f$)	V_{RSOM}	maximum (peak) (nonrepetitive) reverse voltage, gate open
I_L	dc latching current	$t_{g(rec)}$	gate recovery time	V_{RSXM}	maximum (peak) (nonrepetitive) reverse voltage, specified circuit between gate and cathode
I_o	average dc forward current	t_{gt}	gate controlled turn-on time ($t_d + t_r$)	V_{RX}	dc reverse voltage, specified circuit between gate and cathode
I_R	dc reverse current	t_q	circuit commutated turn-off time ($t_{rr} + t_{g(rec)}$)	V_{RXM}	maximum (peak) reverse voltage, specified circuit between gate and cathode
i_R	instantaneous reverse current	t_r	rise time	V_T	instantaneous on-state voltage
i_{RO}	instantaneous reverse current, gate open	t_{rr}	reverse recovery time	$V_{T(I)}$	initial on-state voltage
I_{RM}	maximum (peak) reverse current	t_s	storage time	V_{TM}	maximum (peak) dc on-state voltage
I_{RROM}	maximum (peak) reverse current, gate open	$V_{(BO)}$	breakover voltage	Z_{GS}	gate source impedance
I_{RRX}	dc reverse current, specified circuit between gate and cathode	$ +V_{(BO)} - -V_{(BO)} $	breakover voltage symmetry (for diacs)	ΔV_{\pm}	dynamic breakback voltage
I_{RRXM}	maximum (peak) reverse current, specified circuit between gate and cathode	$V_{(BO)O}$	instantaneous breakover voltage, gate open		
I^2_t	amperes squared-seconds (fusing current for device protection)	V_D	dc off-state voltage		
i_T	instantaneous on-state current	V_{DM}	instantaneous off-state voltage		
I_T	dc on-state current	V_{DSOM}	maximum (peak) (repetitive) off-state voltage, gate open		
I_{TGQM}	maximum (peak) on-state current gate-turn-off capability	V_{DRXM}	maximum (peak) (repetitive) off-state voltage, specified circuit between gate and cathode		
$I_{T(AV)}$	average on-state current	V_{DSOM}	maximum (peak) (nonrepetitive) off-state voltage, gate open		
		V_{DSXM}	maximum (peak) (nonrepetitive) off-state voltage, specified circuit between gate and cathode		

Power Transistors

Technical Data

2N697, 2N699, 2N1613, 2N1711, 2N1893, 2N2102, 2N2270, 2N2405, 2N3053, 2N3053A, 40366, 40389, 40392, 41502

Low-Power Silicon N-P-N Planar Transistors

For Small-Signal Applications In Industrial and Commercial Equipment

These RCA types are silicon n-p-n planar transistors intended for a variety of small-signal and medium-power applications. They feature exceptionally high collector-to-emitter sustaining voltage, low leakage characteristics, high switching speeds, and high pulse beta (h_{FE}).

RCA-2N2102 is a direct replacement for the 2N1613. RCA-2N2405 is a direct replacement for the 2N1893. All of these devices are supplied in the JEDEC TO-39 hermetic package.

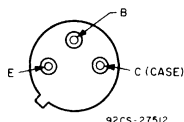
Features:

- Planar construction for low noise and low leakage
- Low output capacitance
- Low saturation voltages

Additional Features for 40366:

- High reliability assured by five pre-conditioning steps
- Group A test data included in data sheet.

TERMINAL DESIGNATIONS



JEDEC TO-39

Maximum Ratings, Absolute-Maximum Values:

- * COLLECTOR-TO-BASE VOLTAGE V_{CB0}
- COLLECTOR-TO-EMITTER SUSTAINING VOLTAGE:
 - With external base-to-emitter resistance (R_{BE}) $\leq 10 \Omega$
 - With base-emitter junction reverse-biased
 - * With base open
- * EMITTER-TO-BASE VOLTAGE V_{EBO}
- * COLLECTOR CURRENT I_C
- * TRANSISTOR DISSIPATION:
 - P_T
 - At case temperatures up to 25°C
 - At free-air temperatures up to 25°C
 - At temperatures above 25°C
- * TEMPERATURE RANGE:
 - Storage T_{stg}
 - Operating (Junction) T_C
- * LEAD TEMPERATURE (During soldering):
 - At distance from seating plane for 10 s max.
 - $\geq 1/16$ in. (1.58 mm) T_L

	2N697	2N699	40366	2N1711	2N1893	2N2270	2N2405	2N3053 40389	40392	2N3053A	41502	
V_{CB0}	60	120	120	75	120	60	120	60	80	—	V	
$V_{CEV(sus)}$	—	80	80	50	100	60	140	50	70	—	V	
$V_{CEV(sus)}$	—	—	—	—	120	—	120	60	80	—	V	
$V_{CEO(sus)}$	—	—	65	—	80	45	90	40	60	30	V	
V_{EBO}	5	5	7	7	7	7	7	5	5	4	V	
I_C	0.5	1	1	1	0.5	1	1	0.7	0.7	1	A	
P_T	2	2	5	3	3	5	5	5 [●]	5	3	W	
	0.6	0.6	1	0.8	0.8	1	1	1 [■]	1	0.8	W	
Derate linearly to maximum temperature												
T_{stg}	-65 to +175		—			-65 to 200		—				°C
T_C	-65 to +175		—			65 to 200		—				°C
T_L	255	230	300	300	255	230	255	235	235	300	°C	

* 2N-Series types in accordance with JEDEC registration data

● 7 for 40392 ■ 3.5 for 40389

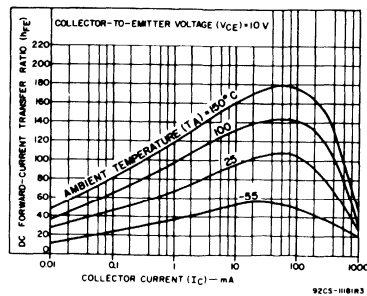


Fig. 1 - Typical dc beta characteristics for 2N699, 2N1613, 2N2102, 2N2270, 41502.

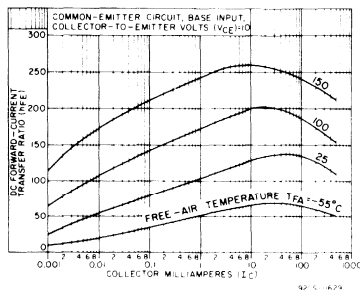


Fig. 2 - Typical dc beta characteristics for 2N1711.

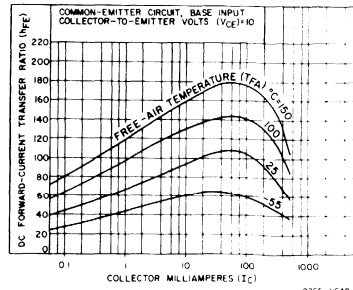


Fig. 3 - Typical dc beta characteristics for 2N1893, 2N2405.

2N697, 2N699, 2N1613, 2N1711, 2N1893, 2N2102, 2N2270, 2N2405, 2N3053, 2N3053A, 40366, 40389, 40392, 41502

ELECTRICAL CHARACTERISTICS, At Case Temperature (T_C) = 25°C unless otherwise specified

CHARACTERISTIC	SYMBOL	TEST CONDITIONS				LIMITS										UNITS	
		VOLTAGE		CURRENT		2N697			2N699		2N1613		2N2102 40366		2N1711		
		V dc		mA dc		MIN.	TYP.	MAX.	MIN.	MAX.	MIN.	MAX.	MIN.	MAX.	MIN.		MAX.
Collector Cutoff Current: With emitter open At $T_C = 150^\circ\text{C}$	I_{CBO}	V_{CB}	V_{CE}	I_C	I_B	—	0.01	1	—	—	—	—	—	—	—	—	
		30	—	—	—	—	—	—	—	—	—	—	—	—	—	—	μA
		60	—	—	—	—	—	—	0.05	—	0.01	—	0.002	—	0.01	—	
60	—	—	—	—	—	—	—	—	10	—	2	—	10	—			
Emitter Cutoff Current: $V_{EB} = 5\text{ V}$	I_{EBO}	—	—	0	—	—	—	—	0.05	—	0.01	—	0.002	—	0.005	μA	
DC Forward-Current Transfer Ratio	h_{FE}	10	0.01	—	—	—	—	—	—	—	—	10	—	20	—	μA	
		10	0.1	—	—	—	—	—	—	—	—	20	—	35	—		
		10	10^a	—	—	—	—	—	—	—	—	35	—	75	—		
		10	150^a	40	—	120	40	120	40	120	40	120	40	120	100		300
		10	500^a	—	—	—	—	—	—	—	—	20	—	25	—		40
At $T_C = -55^\circ\text{C}$	—	10	10^a	—	—	—	—	—	—	20	—	20	—	35	—		
Collector-to-Emitter Reachthrough Voltage: $V_{EB} = 1.5\text{ V}, I_E = 0$	V_{RT}	—	—	—	—	—	—	—	—	—	—	120	—	75	—	V	
Collector-to-Base Breakdown Voltage: With emitter open	$V_{(BR)CBO}$	—	—	0.1	60	75	—	120	—	75	—	120	—	75	—	V	
Emitter-to-Base Breakdown Voltage: $I_E = 0.1\text{ mA}$	$V_{(BR)EBO}$	—	—	0	5	7.5	—	—	—	7	—	7	—	7	—	V	
Collector-to-Emitter Sustaining Voltage: With base open	$V_{CEO(sus)}$	—	—	100^a	0	—	—	—	—	—	—	65	—	—	—	V	
With external base-to-emitter resistance (R_{BE}) = 10 Ω	$V_{CER(sus)}$	—	—	100^a	40	60	—	80	—	50	—	80	—	50	—	V	
Base-to-Emitter Saturation Voltage	$V_{BE(sat)}$	—	—	150^a	15	—	1	1.3	—	1.3	—	1.3	—	1.1	—	1.3	V
Collector-to-Emitter Saturation Voltage	$V_{CE(sat)}$	—	—	150^a	15	—	0.7	1.5	—	5	—	1.5	—	0.5	—	1.5	V
Common-Emitter, Small-Signal, Forward Current Transfer Ratio ($f = 1\text{ kHz}$)	h_{fe}	5	1	—	—	—	—	—	—	35	100	30	100	30	100	50	200
		10	5	—	—	—	—	—	—	—	45	—	35	150	35	150	70
Magnitude of Common-Emitter, Small-Signal, Forward Current Transfer Ratio ($f = 20\text{ MHz}$)	$ h_{fe} $	10	50	2.5	5	—	2.5	—	3	—	3	—	3	—	3.5	—	
Input Resistance: $f = 1\text{ kHz}$	h_{ib}	5	1	—	—	—	—	—	—	20	30	24	34	24	34	24	34
		10	5	—	—	—	—	—	—	—	10	4	8	4	8	4	8
Small-Signal Reverse Voltage Transfer (Feedback) Ratio: $f = 1\text{ kHz}$	h_{rb}	5	1	—	—	—	—	—	—	3×10^{-4}	—	3×10^{-4}	—	3×10^{-4}	—	5×10^{-4}	
		10	1	—	—	—	—	—	—	—	—	3×10^{-4}	—	—	—	—	
		10	5	—	—	—	—	—	—	—	3×10^{-4}	—	—	3×10^{-4}	—	5×10^{-4}	
Output Conductance: $f = 1\text{ kHz}$	h_{ob}	5	1	—	—	—	—	—	0.05	0.5	0.05	0.5	0.01	0.5	0.05	0.5	
		10	5	—	—	—	—	—	—	1	0.05	0.5	0.01	1	0.05	0.5	
Output Capacitance: $I_E = 0$	C_{ob}	10	—	—	—	—	—	—	—	—	—	—	15	—	25	pF	
Input Capacitance: $V_{EB} = 0.5\text{ V}$	C_{ib}	—	—	0	—	—	—	—	—	—	—	80	—	80	—	80	
Gain-Bandwidth Product	f_T	—	—	—	50	100	—	50	—	60	—	60	—	70	—	MHz	
Noise Figure: Circuit Bandwidth (BW) = 1 Hz Reference signal freq. = 1 kHz Generator resistance (R_G) = 510 Ω (2N1613, 2N1711) 1 K Ω (2N2102)	NF	10	0.3	—	—	—	—	—	—	—	—	—	12	—	8	dB	
Saturated Switching Time	$t_{g^*} + t_f$	—	—	—	—	—	—	—	—	—	—	30	—	30	—	ns	
Thermal Resistance: Junction-to-case	$R_{\theta JC}$	—	—	—	—	—	—	75	—	75*	—	58.3*	—	35*	—	58.3*	
Junction-to-ambient	$R_{\theta JA}$	—	—	—	—	—	—	250	—	250*	—	219*	—	175*	—	219*	

*2N-Series types in accordance with JEDEC registration data

^a Pulsed, pulse duration = 300 μs , duty factor = 2% (1.8% for 2N2102 only).

POWER TRANSISTORS

2N697, 2N699, 2N1613, 2N1711, 2N1893, 2N2102, 2N2270, 2N2405, 2N3053, 2N3053A, 40366, 40389, 40392, 41502

ELECTRICAL CHARACTERISTICS, At Case Temperature (T_C) = 25°C unless otherwise specified.

CHARACTERISTIC	SYMBOL	TEST CONDITIONS				LIMITS										UNITS		
		VOLTAGE V dc		CURRENT mA dc		2N1893		2N2405		2N2270		2N3053 40389 40392		2N3053A			41502	
		V _{CB}	V _{CE}	I _C	I _B	MIN.	MAX.	MIN.	MAX.	MIN.	MAX.	MIN.	MAX.	MIN.	MAX.		MIN.	MAX.
Collector Cutoff Current: With emitter open	I _{CBO}	15				-	-	-	-	-	-	-	-	-	-	-	2	
		30				-	-	-	-	-	-	0.25	-	-	-	-	μA	
		60				-	-	-	-	0.05	-	-	-	-	-	-		
		90				-	0.01	-	0.01	-	-	-	-	-	-	-		
At T _C = 150°C		60				-	-	-	-	-	50	-	-	-	-	-		
		90				-	15	-	10	-	-	-	-	-	-	-		
Emitter Cutoff Current: V _{EB} = 5 V, (4 V for 2N3053, 2N3053A)	I _{EBO}			0		-	0.01	-	0.01	-	0.1	-	0.25	-	0.25	-	μA	
DC Forward Current Transfer Ratio	h _{FE}		10	0.1		-	-	20	-	-	-	-	-	-	-	-		
			10	1		-	-	-	-	-	30	-	-	-	-	-		
			10	10 ^a		35	-	35	-	-	-	-	-	-	-	-		
			10	150 ^a		40	120	60	200	50	200	50	250	50	250	20		
At T _C = 55°C		10	10 ^a		20	-	20	-	-	-	-	-	-	-	-			
Collector-to-Base Breakdown Voltage: With emitter open	V _{(BR)CBO}			0.1		120	-	120	-	60	-	60	-	80	-	-	V	
Emitter-to-Base Breakdown Voltage: I _E = 0.1 mA	V _{(BR)EBO}			0		7	-	7	-	7	-	5	-	5	-	4	V	
Collector-to-Emitter Sustaining Voltage: With base open	V _{CE0(sus)}		100 ^a	0		-	-	90	-	45	-	40	-	-	-	-		
			30 ^a	0		80	-	90	-	-	-	-	-	-	30	-	V	
With external base-to-emitter resistance (R _{BE}) = 10Ω = 500Ω	V _{CE0(sus)}		100 ^a	0		100	-	140	-	60	-	50	-	70	-	-	V	
			100 ^a	0		100	-	120	-	60	-	50	-	70	-	-	V	
Base-to-Emitter Saturation Voltage	V _{BE(sat)}		150 ^a	15		1.3	-	1.1	-	0.9	-	1.4	0.6	1	-	-	V	
			50 ^a	5		0.9	-	0.9	-	-	-	-	-	-	-	-	V	
Collector-to-Emitter Saturation Voltage	V _{CE(sat)}		150 ^a	15		5	-	0.5	-	1.2	-	1.7	-	0.3	-	1.5	V	
			50 ^a	5		1.3	-	0.2	-	-	-	-	-	-	-	-	V	
Base-to-Emitter Voltage	V _{BE}	2.5	150	150 ^a		-	-	-	-	-	-	1.7	-	1	-	2.5	V	
		10				-	-	-	-	-	-	-	-	-	-	-	V	
Common Emitter, Small-Signal, Forward Current Transfer Ratio	h _{fe}		5	1		30	100	-	-	-	-	-	-	-	-	-		
			5	5		-	-	50	275	5	-	-	-	-	-	-		
			10	5		45	-	-	-	5	275	-	-	-	-	-		
			10	50		2.5 ^a	-	6	-	5 ^a	-	5 ^a	-	5	-	-		
Input Resistance: f = 1 kHz	h _{ib}	5	1		20	30	24	34	-	-	-	-	-	-	-	-	Ω	
		10	5		4	8	4	8	-	-	-	-	-	-	-	-	Ω	
Small Signal Reverse Voltage Transfer (Feedback) Ratio: f = 1 kHz	h _{rb}	5	1		-	1.25 x 10 ⁻⁴	-	3 x 10 ⁻⁴	-	-	-	-	-	-	-	-		
		10	5		-	1.25 x 10 ⁻⁴	-	3 x 10 ⁻⁴	-	-	-	-	-	-	-	-		
Output Conductance: f = 1 kHz	h _{ob}	5	1		-	0.5	-	0.5	-	-	-	-	-	-	-	-	μmho	
		10	5		-	0.5	-	0.5	-	-	-	-	-	-	-	-	μmho	
Output Capacitance: I _E = 0	C _{ob}	10			-	15	-	15	-	15	-	15	-	15	-	25	pF	
Input Capacitance: V _{EB} = 0.5 V	C _{ib}			0		85	-	85	-	80	-	80	-	80	-	80	pF	
Gain-Bandwidth Product	f _T				50	-	120	-	100	-	100	-	100	-	100	-	MHz	
Noise Figure: Circuit Bandwidth (BW) = 1 Hz Reference signal freq. = 1 kHz Generator resistance (R _G) = 500 Ω (2N2405) 1 kΩ (2N2270)	NF		10	0.3		-	-	6	-	10 ^a	-	-	-	-	-	-	dB	
																		dB
Saturated Switching Time	t _d +t _r +t _f					-	-	-	-	30	-	-	-	-	-	-	ns	
Thermal Resistance: Junction-to case	R _{θJC}					-	58.3	-	35	-	35	-	35 ^a	-	35	-	58.3	°C/W
							-	219	-	175	-	175	-	175 ^a	-	175	-	219

* 2N Series types in accordance with JEDEC registration data.

^a Pulsed; pulse duration = 300 μs, duty factor ≤ 2%.

2N697, 2N699, 2N1613, 2N1711, 2N1893, 2N2102, 2N2270, 2N2405, 2N3053, 2N3053A, 40366, 40389, 40392, 41502

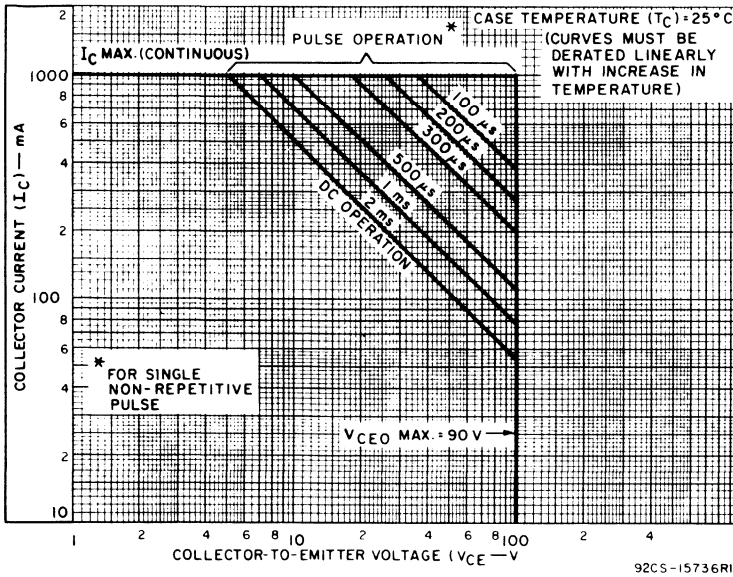


Fig. 4 - Maximum operating areas for 2N2405.

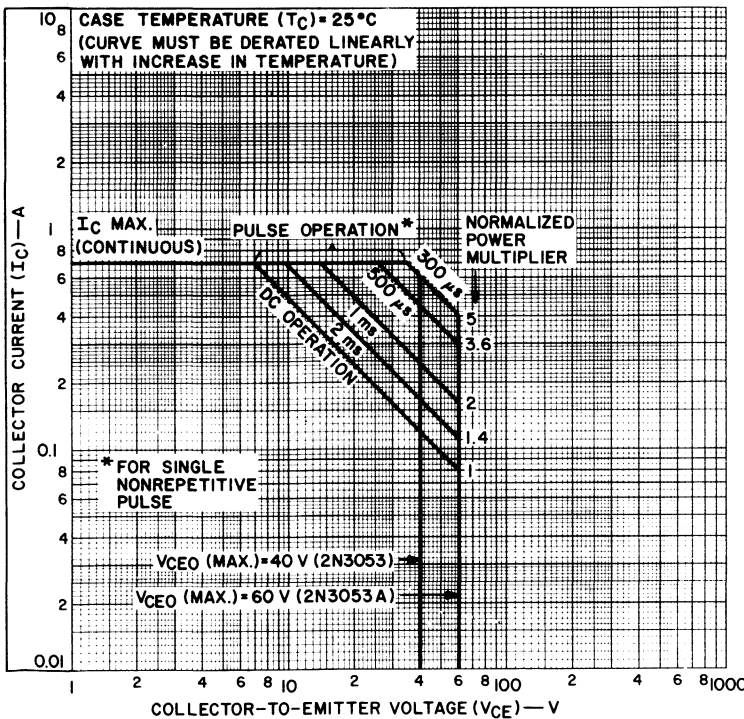


Fig. 5 - Maximum operating areas for 2N3053 and 2N3053A.

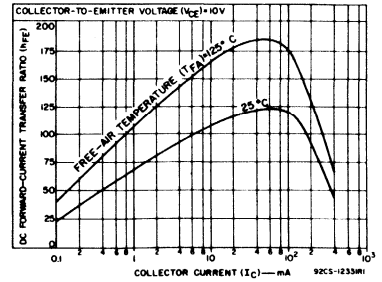


Fig. 6 - Typical dc beta characteristics for 2N3053, 2N3053A, 40389, 40392.

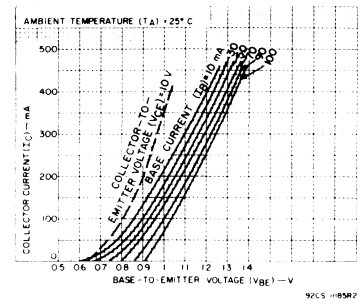


Fig. 7 - Typical transfer characteristics for 2N1613, 2N1711, 2N1893, 2N2102, 2N2405.

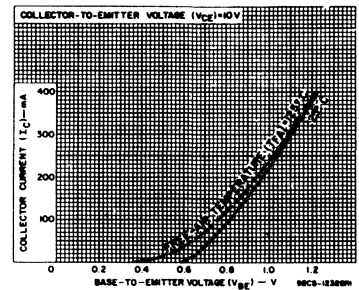


Fig. 8 - Typical transfer characteristics for 2N3053, 2N3053A, 40389, 40392.

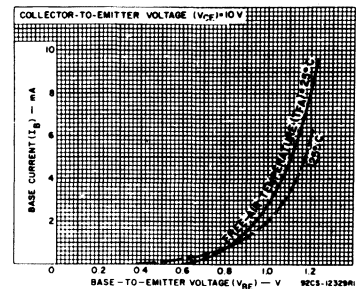


Fig. 9 - Typical input characteristics for 2N3053, 2N3053A, 40389, 40392.

POWER TRANSISTORS

2N697, 2N699, 2N1613, 2N1711, 2N1893, 2N2102, 2N2270, 2N2405, 2N3053, 2N3053A, 40366, 40389, 40392, 41502

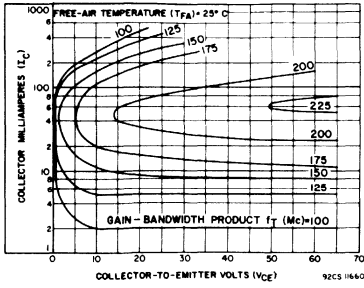


Fig. 10 - Typical gain bandwidth product (f_T) for 2N1711, 2N1893, 2N2405.

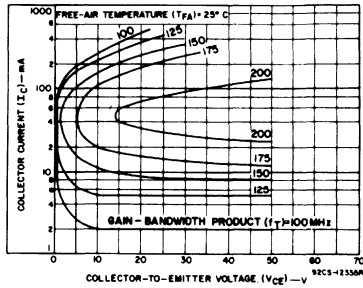


Fig. 11 - Typical gain bandwidth product (f_T) for 2N699, 2N1613, 2N2102, 2N2270, 2N3053, 2N3053A, 40389, 40392.

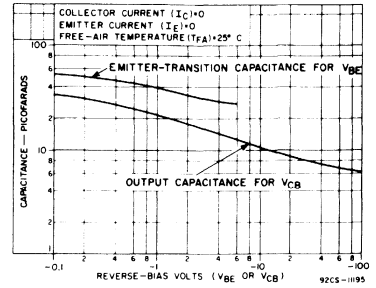


Fig. 12 - Typical capacitance characteristics for all types.

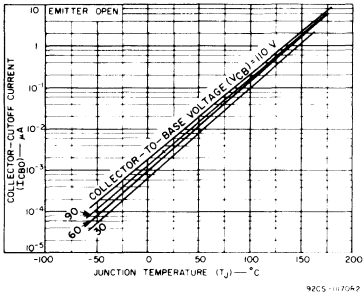


Fig. 13 - Typical collector-cutoff current characteristics for 2N699, 2N1893, 2N2405.

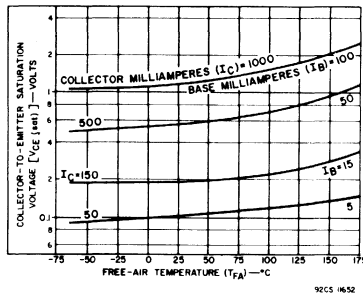


Fig. 14 - Typical collector-to-emitter saturation characteristics for 2N1893, 2N2405.

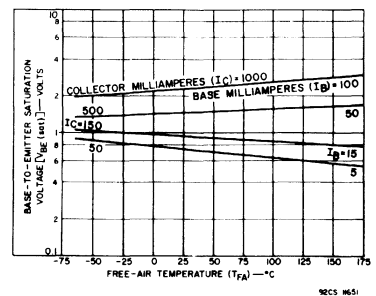


Fig. 15 - Typical base-to-emitter saturation characteristics for 2N1893, 2N2405.

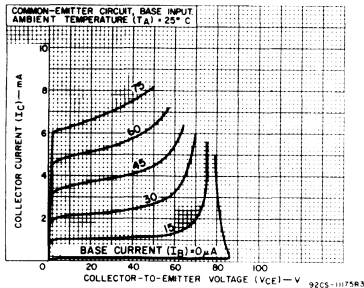


Fig. 16 - Typical low-current output characteristics for 2N699, 2N1613, 2N2102, 2N2270, 41502.

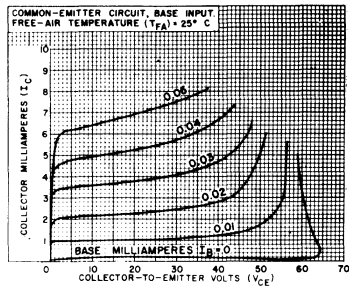


Fig. 17 - Typical low-current output characteristics for 2N1711.

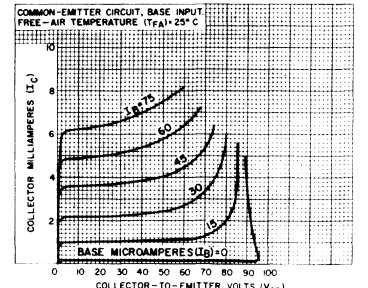


Fig. 18 - Typical low-current output characteristics for 2N1893.

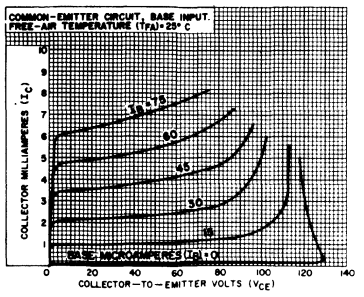


Fig. 19 - Typical low-current output characteristics for 2N2405.

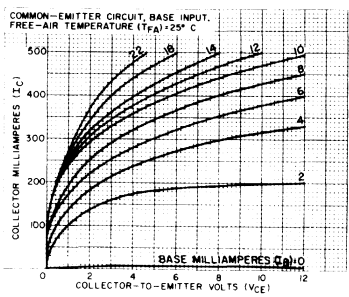


Fig. 20 - Typical high-current output characteristics for 2N699, 2N2270.

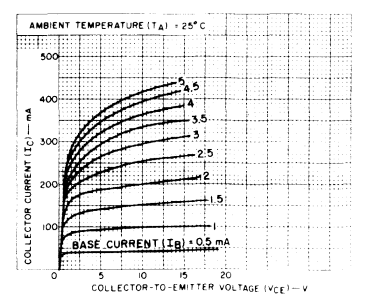


Fig. 21 - Typical high-current output characteristics for 2N1613, 2N2102, 41502.

2N697, 2N699, 2N1613, 2N1711, 2N1893, 2N2102, 2N2270, 2N2405, 2N3053, 2N3053A, 40366, 40389, 40392, 41502

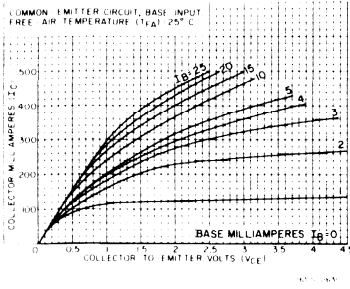


Fig. 22 - Typical high-current output characteristics for 2N1711.

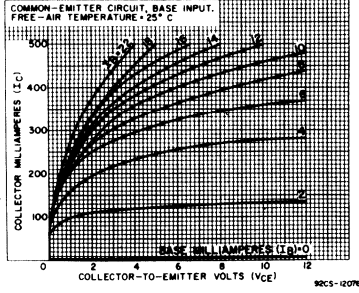


Fig. 23 - Typical high-current output characteristics for 2N1893.

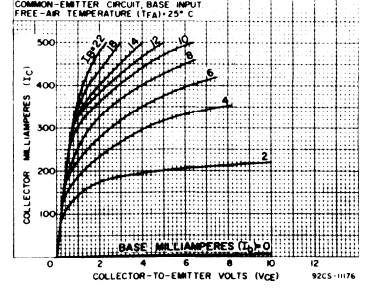


Fig. 24 - Typical high-current output characteristics for 2N2405.

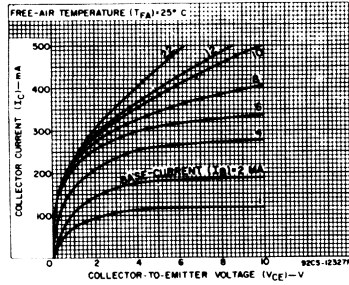


Fig. 25 - Typical high-current output characteristics for 2N3053, 2N3053A, 40389, 40392.

2N1479-2N1482, 2N1700, 40347-40349, 40367

Hometaxial-Base Silicon N-P-N Power Transistors

General-Purpose Types for Low-Power Applications

These RCA types are hometaxial-base, silicon n-p-n power transistors intended for a wide variety of applications in industrial and military equipment. They are particularly useful in power-switching circuits such as in dc-to-dc converters, inverters, choppers, solenoid and relay controls; in oscillator, regulator, and pulse-amplifier circuits; and as class A

and class B push-pull audio and servo amplifiers.

The 2N1700 and 40367 are supplied in the hermetic JEDEC TO-39 package or TO-39 with factory-attached mounting flange or heat radiator.

Features:

- High-temperature characterization
- High dc beta at 200 mA
- Full switching-time characterization at 200 mA

Additional features for 40367:

- High reliability assured by five preconditioning steps
- Group A test data in data bulletin

Maximum Ratings, Absolute-Maximum Values:

	2N1479	2N1480		40347	40348	40349	
	2N1481	2N1482	2N1700	40347V1	40348V1	40349V1	40367
	2N1481	2N1482	2N1700	40347V2	40348V2	40349V2	40367
* COLLECTOR-TO-BASE VOLTAGE V _{CBO}	60	100	60	60	90	160	100 V
* COLLECTOR-TO-EMITTER VOLTAGE:							
With base open, sustaining V _{CEO(sus)}	40	55	40	40	65	140	55 V
With emitter-to-base reverse biased (V _{EB} = 1.5 volts) V _{CEV}	60	100	60	60	90	160	100 V
* EMITTER-TO-BASE VOLTAGE V _{EBO}	12	12	6	7	7	7	12 V
* COLLECTOR CURRENT I _C	1.5	1.5	1	1.5	1.5	1.5	1.5 A
PEAK COLLECTOR CURRENT I _{CM}	—	—	—	3.0	3.0	3.0	— A
* EMITTER CURRENT I _E	-1.75	-1.75	—	—	—	—	— A
* BASE CURRENT I _B	1	1	0.75	0.5	0.5	0.5	1 A
* TRANSISTOR DISSIPATION: P _T							
At case temperature of 25°C	5	5	5	11.7	11.7	11.7	5 W
				(40347V2)	(40348V2)	(40349V2)	
				8.75	8.75	8.75	
				(40347)	(40348)	(40349)	
At ambient temperature up to 25°C	—	—	—	1.0	1.0	1.0	1 W
				(40347)	(40348)	(40349)	
				4.4	4.4	4.4	
				(40347V1)	(40348V1)	(40349V1)	
* TEMPERATURE RANGE:							
Operating and Storage T _C , T _{stg}				← -65 to 200 →			°C
* LEAD TEMPERATURE (During soldering):							
At distances ≥ 1/32 in (0.8 mm) from seating plane for 10 s max. T _L	—	—	255	230	230	230	255°C
* 2N-Series types in accordance with JEDEC registration data							

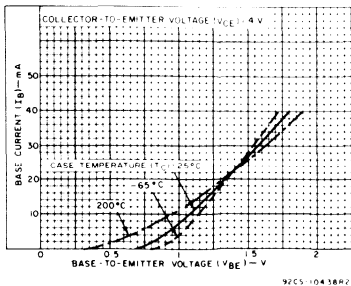


Fig. 1 — Typical input characteristics for 2N1479-2N1482.

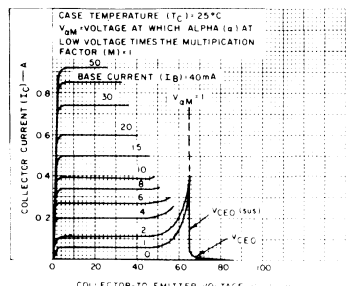
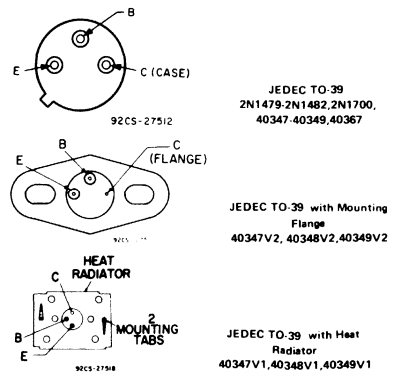


Fig. 2 — Typical output characteristics for 2N1479-2N1482.

TERMINAL DESIGNATIONS



2N1479-2N1482, 2N1700, 40347-40349, 40367

ELECTRICAL CHARACTERISTICS, At Case Temperature (T_C) = 25°C unless otherwise specified

CHARACTERISTIC	SYMBOL	TEST CONDITIONS						LIMITS								UNITS						
		VOLTAGE		CURRENT				2N1479		2N1480		2N1481		2N1482			2N1700		40367			
		V _{CB}	V _{CE}	V _{EB}	I _C	I _B	I _E	MIN.	MAX.	MIN.	MAX.	MIN.	MAX.	MIN.	MAX.		MIN.	MAX.	MIN.	MAX.		
Collector Cutoff Current: $T_C = 150^\circ\text{C}$	I _{CBO}	30					0	—	10	—	10	—	10	—	10	—	75	—	4	μA		
Emitter Cutoff Current	I _{EBO}	30				0	—	500	—	500	—	500	—	500	—	1000	—	—	—	2	μA	
Collector-To-Emitter Voltage: With base-emitter junction reverse-biased	V _{CEV}			12	0		60	—	100	—	60	—	100	—	—	—	100	—	—	—	V	
With base open, sustaining	V _{CEO(sus)}			6	0		—	—	—	—	—	—	—	—	—	60	—	—	—	—	V	
Base-To-Emitter Voltage	V _{BE}	4		200			—	3	—	3	—	3	—	3	—	—	—	—	—	3	V	
Collector-Emitter Saturation Voltage	V _{CE(sat)}	4		100			—	—	—	—	—	—	—	—	—	—	2	—	—	—	V	
DC Current Transfer Ratio	h _{FE}	4		200			20	60	20	60	35	100	35	100	—	—	—	—	35	100		
Small-Signal Current Transfer Ratio	h _{fe}	4		100			—	—	—	—	—	—	—	—	20	80	—	—	—	—		
DC Collector-To-Emitter Saturation Resistance	r _{CE(sat)}			5			50 Typ.*		50 Typ.*		50 Typ.*		50 Typ.*		40 Typ.							Ω
Collector-To-Base Capacitance	C _{ob}	40		200	20		—	7	—	7	—	—	—	—	—	—	—	—	—	—	—	pF
Thermal Time Constant	τ ₁			100	10		—	—	—	—	—	—	—	—	—	—	—	—	—	—	—	ms
Alpha-Cutoff Frequency	f _{αb}	28		100	10		—	—	—	—	—	—	—	—	—	—	—	—	—	—	—	MHz
Switching Time:				5			1.5 Typ.*		1.5 Typ.*		1.5 Typ.*		1.5 Typ.*		1.5 Typ.							
Delay Time	t _d						0.2 Typ.*		0.2 Typ.*		0.2 Typ.*		0.2 Typ.*		0.2 Typ.							
Rise Time	t _r						1 Typ.*		1 Typ.*		1 Typ.*		1 Typ.*		1 Typ.							
Storage Time	t _s						0.6 Typ.*		0.6 Typ.*		0.6 Typ.*		0.6 Typ.*		0.6 Typ.							
Fall Time	t _f						1 Typ.*		1 Typ.*		1 Typ.*		1 Typ.*		1 Typ.							
Thermal Resistance:																						
Junction-to-case	R _{θJC}						35		35		35		35		35							35
Junction-to-free air	R _{θJFA}						200		200		200		200		200							—

*2N-Series types in accordance with JEDEC registration data.

• I_C = 200 mA, I_{B1} = 20 mA, I_{B2} = -85 mA

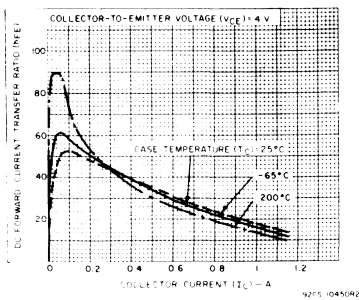


Fig. 3— Typical dc beta characteristics for 2N1479-2N1482.

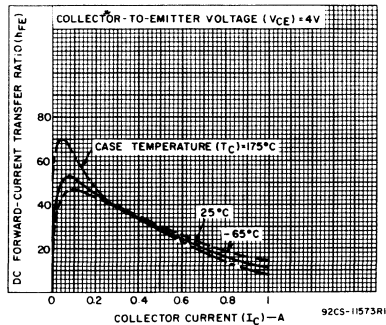


Fig. 4— Typical dc beta characteristics for 2N1700.

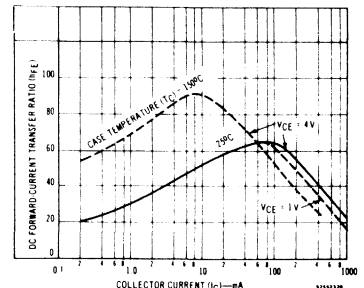


Fig. 5— Typical dc beta characteristics for 40347.

2N1479-2N1482, 2N1700, 40347-40349, 40367

ELECTRICAL CHARACTERISTICS, At Case Temperature (T_C) = 25°C unless otherwise specified

CHARACTERISTIC	SYMBOL	TEST CONDITIONS				LIMITS						UNITS
		VOLTAGE		CURRENT		40347		40348		40349		
		V dc		A dc		MIN.	MAX.	MIN.	MAX.	MIN.	MAX.	
		V _{CE}	V _{BE}	I _C	I _B							
Collector-Cutoff Current With external base-to-emitter resistance (R_{BE}) = 1 k Ω	I _{CER}	30				—	1	—	—	—	—	μ A
		60				—	—	—	1	—	—	
		90				—	—	—	—	—	2	
With R_{BE} = 1 k Ω and T_C = 150°C	I _{CER}	30				—	1	—	—	—	—	mA
		60				—	—	—	1	—	—	
		90				—	—	—	—	—	1	
Emitter-Cutoff Current	I _{EBO}		-7			—	10	—	10	—	10	μ A
DC Forward-Current Transfer Ratio	h _{FE}	4		0.15		—	—	—	—	30	125	
		4		0.30		—	—	30	125	—	—	
		4		0.45		25	100	—	—	10	—	
		4		1.00		—	—	10	—	—	—	
Collector-to-Emitter Sustaining Voltage: With base-emitter junction reverse biased	V _{CEV(sus)}		-1.5	0.050		60	—	90	—	160 ^a	—	V
	V _{CEO(sus)}			0.050		40	—	65	—	140 ^a	—	V
Base-to-Emitter Voltage	V _{BE}	4		0.15		—	—	—	—	—	1.1	V
		4		0.30		—	—	—	1.3	—	—	
		4		0.45		—	1.5	—	—	—	—	
Collector-to-Emitter Saturation Voltage	V _{CE(sat)}			0.15	15 mA	—	—	—	—	—	0.15	V
				0.30	30 mA	—	—	—	0.75	—	—	
				0.45	45 mA	—	1	—	—	—	—	
Forward-Bias Second Break-down Collector Current (1-s non-repetitive pulse)	I _{S/b}	38				345	—	—	—	—	—	mA
		63				—	—	208	—	—	—	
		138				—	—	—	—	95	—	
Thermal Resistance: Junction-to-Case	R θ_{JC}					20(max.)	—	20(max.)	—	20(max.)	—	$^{\circ}$ C/W
						40347	—	40348	—	40349	—	
						15(max.)	—	15(max.)	—	15(max.)	—	
						40347V2	—	40348V2	—	40349V2	—	
Thermal Resistance: Junction-to-Ambient	R θ_{JA}					40(max.)	—	40(max.)	—	40(max.)	—	$^{\circ}$ C/W
						40347V1	—	40348V1	—	40349V1	—	

^a Pulsed; pulse duration = 300 μ s, duty factor \leq 2%.

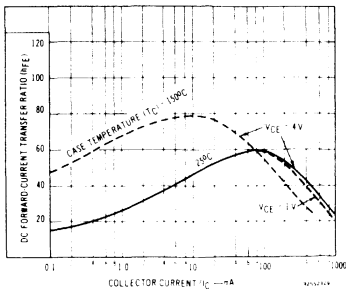


Fig.6—Typical dc beta characteristics for 40348.

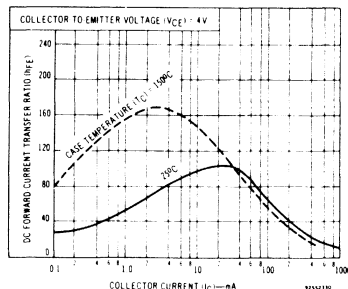


Fig.7—Typical dc beta characteristics for 40349.

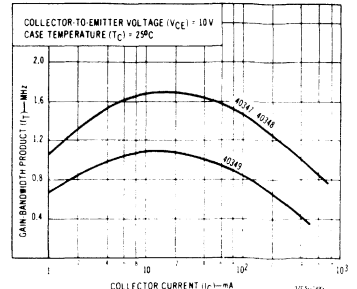


Fig.8—Typical gain-bandwidth product vs. collector current for 40347, 40348 and 40349.

2N1479-2N1482, 2N1700, 40347-40349, 40367

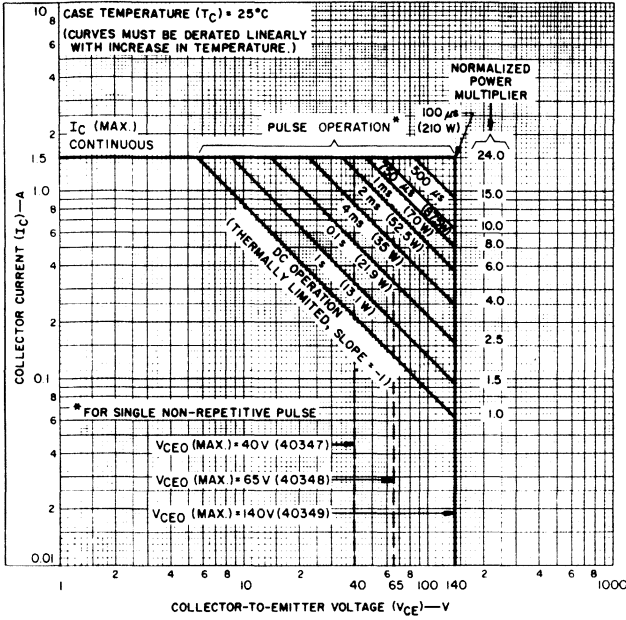


Fig. 9—Maximum operating areas for 40347, 40348, and 40349.

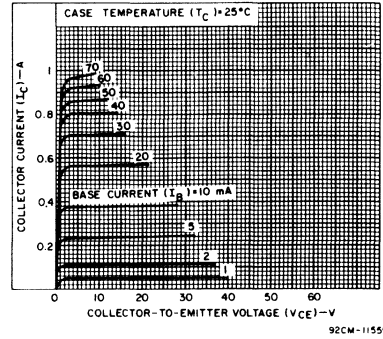


Fig. 10—Typical output characteristics for 2N1700.

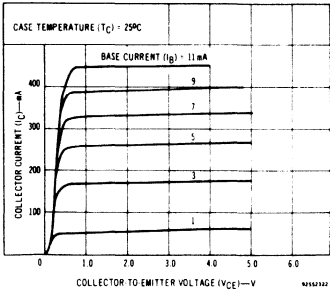


Fig. 11—Typical output characteristics for 40347.

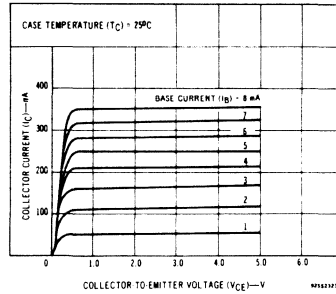


Fig. 12—Typical output characteristics for 40348.

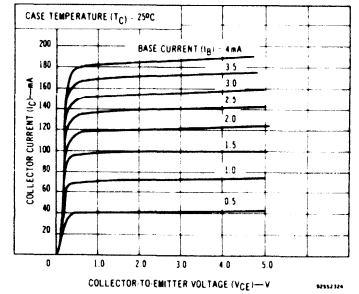


Fig. 13—Typical output characteristics for 40349.

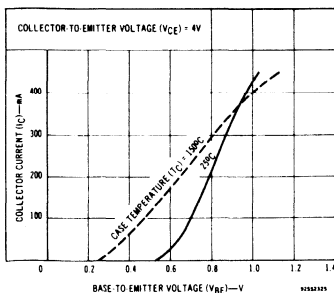


Fig. 14—Typical transfer characteristics for 40347.

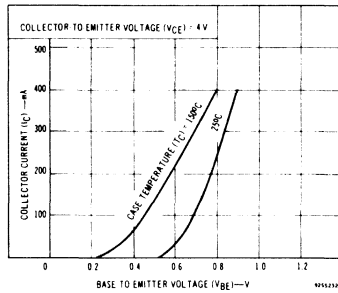


Fig. 15—Typical transfer characteristics for 40348.

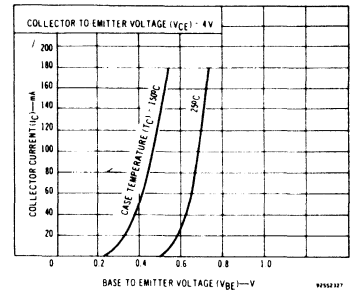


Fig. 16—Typical transfer characteristics for 40349.

2N1479-2N1482, 2N1700, 40347-40349, 40367

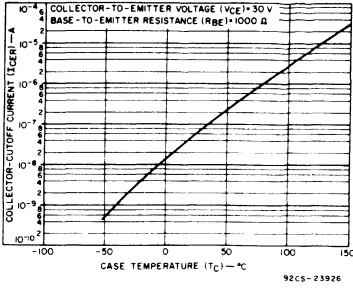


Fig. 17—Collector-cutoff-current characteristic for 40347.

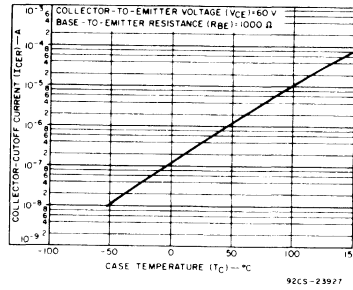


Fig. 18—Collector-cutoff-current characteristic for 40348.

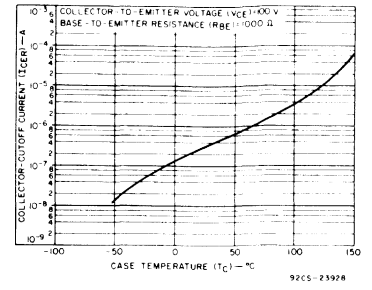


Fig. 19—Collector-cutoff-current characteristic for 40349.

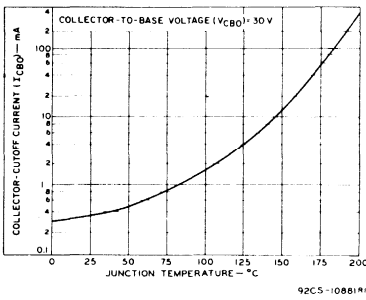


Fig. 20—Typical leakage characteristics for 2N1479-2N1482.

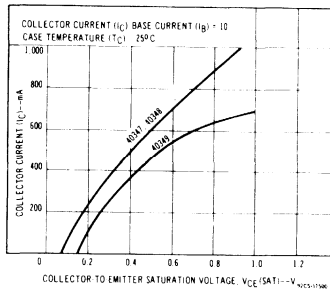


Fig. 21—Typical saturation characteristics for 40347, 40348 and 40349.

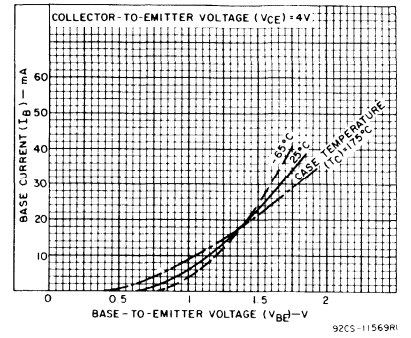


Fig. 22—Typical input characteristics for 2N1700.

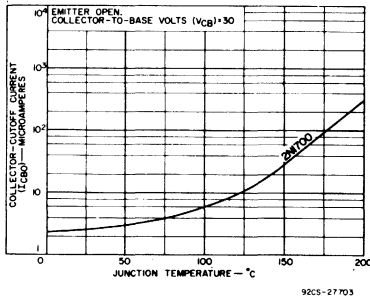


Fig. 23—Typical leakage characteristics for 2N1700.

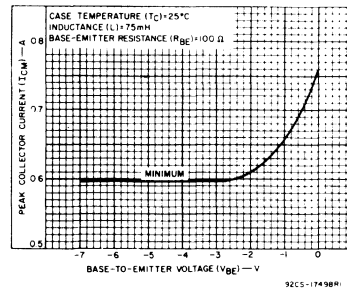


Fig. 24—Reverse-bias second-breakdown characteristics for 40347, 40348 and 40349.

2N1483-2N1486, 2N1701, 40368

Hometaxial-Base Silicon N-P-N Power Transistors

General-Purpose Types for Medium-Power Applications

These RCA types are hometaxial-base power transistors of the silicon n-p-n type intended for a wide variety of applications in industrial and military equipment. They are particularly useful in power-switching circuits such as dc-to-dc converters, inverters, choppers, solenoid and relay control; in oscillator,

regulator, and pulse amplifier circuits; and as class-A and class-B push-pull audio and servo amplifiers.

These transistors feature high beta at high current, and excellent high-temperature performance. They are supplied in the JEDEC TO-8 hermetic package.

Maximum Ratings, Absolute-Maximum Values:

	2N1483 2N1485	2N1484 2N1486 40368	2N1701	
* COLLECTOR-TO-BASE VOLTAGE	60	100	60	V
* COLLECTOR-TO-EMITTER VOLTAGE				
With base open (sustaining voltage)	$V_{CE0(sus)}$	40	55	40 V
With emitter-to-base reverse biased (V_{EB}) = 1.5 volts)	V_{CEV}	60	100	60 V
* EMITTER-TO-BASE VOLTAGE	V_{EBO}	12	12	6 V
* COLLECTOR CURRENT	I_C	3	3	2.5 A
* EMITTER CURRENT	I_E	-3.5	-3.5	- A
* BASE CURRENT	I_B	1.5	1.5	1 A
* TRANSISTOR DISSIPATION	P_T			
At case temperature of 25°C		25	25	25 W
At case temperature of 100°C		14.1	14.1	
* TEMPERATURE RANGE				
Operating and Storage	T_J, T_{stg}	-65 to +200		°C
PIN TEMPERATURE (During soldering)				
At distance $\geq 1/32$ in. (0.79 mm) from seating plane for 10 s max	T_1		235	°C

*2N-Series types in accordance with JEDEC registration data

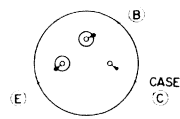
Features:

- High-temperature characterization
- High dc beta at 750 mA
- Full switching-time characterization at 750 mA

Additional Features for 40368:

- High reliability assured by five pre-conditioning steps
- Group A test data in data bulletin.

TERMINAL DESIGNATIONS



JEDEC-TO-8

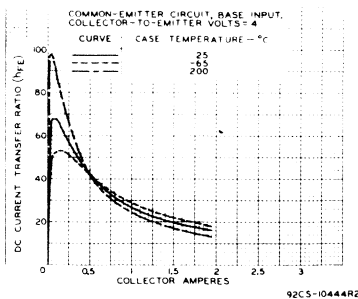


Fig. 1 - Typical dc beta characteristics for 2N1483-2N1486, and 40368.

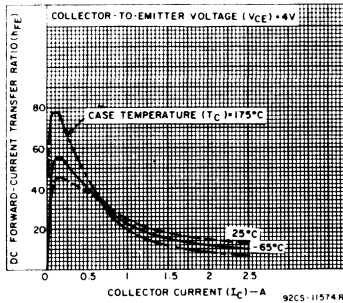


Fig. 2 - Typical dc beta characteristics for 2N1701.

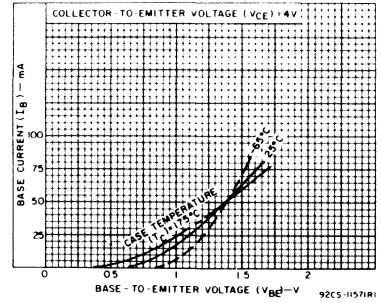


Fig. 3 - Typical input characteristics for 2N1701.

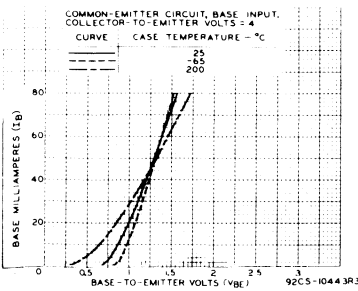


Fig. 4 - Typical input characteristics for 2N1483-2N1486, and 40368.

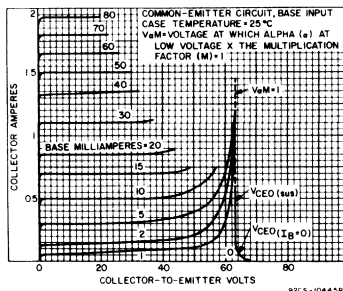


Fig. 5 - Typical output characteristics for 2N1483-2N1486, and 40368.

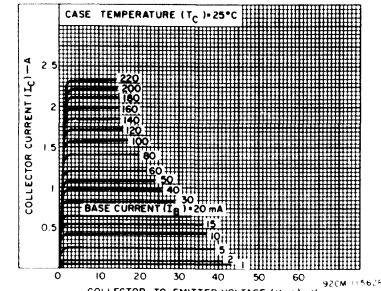


Fig. 6 - Typical output characteristics for 2N1701.

2N1483-2N1486, 2N1701, 40368

ELECTRICAL CHARACTERISTICS, at Case Temperature (T_C) = 25°C unless otherwise specified

CHARACTERISTIC	TEST CONDITIONS				LIMITS								UNITS				
	VOLTAGE V dc		CURRENT mA dc		2N1483		2N1484		2N1485		2N1486			2N1701		40368	
	V_{CB}	V_{CE}	I_C	I_B	MIN.	MAX.	MIN.	MAX.	MIN.	MAX.	MIN.	MAX.		MIN.	MAX.	MIN.	MAX.
* I_{CBO}	60 30				-	15	-	15	-	15	-	15	-	750 100	-	-	μA
At $T_C = 150^\circ C$	30				-	750	-	750	-	750	-	750	-	1500	-	-	
* I_{EBO} $V_{EB} = 12 V$ $= 6$			0 0		-	15	-	15	-	15	-	15	-	- 50	-	-	μA
* h_{FE}		4 4 20	750 ^a 300 ^a 2500 ^a		20	60	20	60	35	100	35	100	- 20 5	- 80	35	100	
* $V_{CE0(sus)}$			100 ^a	0	40	-	55	-	40	-	55	-	40 ^b	-	55	-	V
* V_{CEV} $V_{BE} = -1.5 V$			0.25		60	-	100	-	60	-	100	-	-	-	100	-	V
* V_{CEX} $V_{BE} = -1.5 V$			0.75		-	-	-	-	-	-	-	-	60 ^b	-	-	-	V
* V_{BE}		4 4 20	750 ^a 300 ^a 2500 ^a		-	3.5	-	3.5	-	2.5	-	2.5	-	- 3 13	-	2.5	V
* $V_{CE(sat)}$			750 2500 ^a	40 1000	-	-	-	-	-	-	-	-	-	-	12.5	-	V
* $r_{CE(sat)}$			750 300	75 30	-	2.67	-	2.67	-	1	-	1	-	-	5	-	Ω
* C_{ob}	40				175 (typ.)		175 (typ.)		175 (typ.)		175 (typ.)		175 (typ.)		-	-	pF
* τ_1					10 (typ.)		10 (typ.)		10 (typ.)		10 (typ.)		10 (typ.)		-	-	ms
* $f_{\alpha b}$	28		5		1.25 (typ.)		1.25 (typ.)		1.25 (typ.)		1.25 (typ.)		-		-	-	MHz
* f_{hfb}	6 28		5 100		-	-	-	-	-	-	-	-	350	-	-	-	kHz
			0.5	100	-	-	-	-	-	-	-	-	1 (typ.)	-	-	-	MHz
* t_d^\bullet					0.2 (typ.)		0.2 (typ.)		0.2 (typ.)		0.2 (typ.)		0.2 (typ.)		-	-	μs
* t_r^\bullet					1 (typ.)		1 (typ.)		1 (typ.)		1 (typ.)		1 (typ.)		-	-	
* t_s^\bullet					0.8 (typ.)		0.8 (typ.)		0.8 (typ.)		0.8 (typ.)		0.8 (typ.)		-	-	
* t_f^\bullet					1.1 (typ.)		1.1 (typ.)		1.1 (typ.)		1.1 (typ.)		1.1 (typ.)		-	-	
* $R_{\theta JC}$					-	7	-	7	-	7	-	7	-	7	-	7	$^\circ C/W$
* $R_{\theta JA}$					-	100	-	100	-	100	-	100	-	100	-	100	$^\circ C/W$

^a Pulsed, pulse duration = 300 μs , duty factor = 1.8%.

^b $I_C = 750 \text{ mA}$, $I_{B1} = 20 \text{ mA}$, $I_{B2} = -8.5 \text{ mA}$.

* 2N-Series types in accordance with JEDEC registration data.

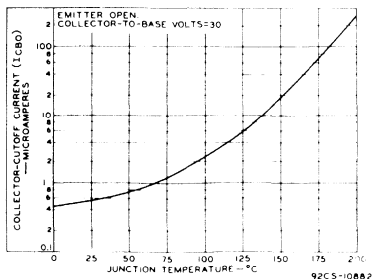


Fig. 7 - Typical collector-cutoff current for 2N1483-2N1486 and 40368.

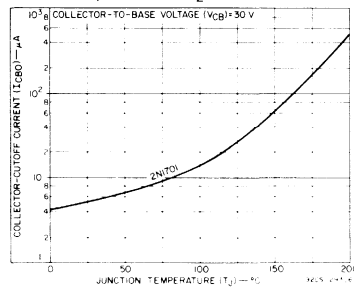


Fig. 8 - Typical collector-cutoff current characteristics for 2N1701.

2N1487-2N1490, 2N1702, 40369

Hometaxial-Base Silicon N-P-N Power Transistors

General-Purpose Types for High-Power Applications

These RCA types are hometaxial-base power transistors of the silicon n-p-n type intended for a wide variety of applications in industrial and military equipment. They are particularly useful in power-switching circuits such as in dc-to-dc converters, inverters, choppers, solenoid and relay controls; in oscillator,

regulator, and pulse-amplifier circuits; and as class-A and class-B push-pull audio and servo amplifiers.

These transistors feature high power-dissipation ratings, high beta at high current, and excellent high-temperature performance. They are supplied in the JEDEC TO-3 hermetic package.

Features:

- High-temperature characterization
- High dc beta at 1.5A
- Full switching-time characterization at 1.5A

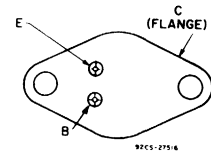
Additional Features for 40369:

- High reliability assured by five pre-conditioned steps
- Group A test data included.

Maximum Ratings, Absolute-Maximum Values:

	2N1487 2N1489	2N1488 2N1490 40369	2N1702		
* COLLECTOR-TO-BASE VOLTAGE	V _{CB0}	60	100	60	V
* COLLECTOR-TO-EMITTER VOLTAGE: With base open (sustaining voltage)	V _{CE0(sus)}	40	55	40	V
With emitter-to-base reverse biased (V _{EB}) = 1.5 volts	V _{CEV}	60	100	60	V
* EMITTER-TO-BASE VOLTAGE	V _{EB0}	10	10	6	V
* COLLECTOR CURRENT	I _C	6	6	5	A
* EMITTER CURRENT	I _E	-8	-8	-	A
* BASE CURRENT	I _B	3	3	2.5	A
* TRANSISTOR DISSIPATION: At mounting-flange temperature of 25°C	P _T	75	75	75	W
At mounting-flange temperature of 100°C		43	43		W
* TEMPERATURE RANGE: Operating and Storage	T _C , T _{stg}	-65 to 200			°C
PIN TEMPERATURE (During soldering): At distance ≥ 1/32 in. (0.79 mm) from seating plane for 10 s max.	T _L	235			°C

TERMINAL DESIGNATIONS



JEDEC TO-3

*2N-Series types in accordance with JEDEC registration data

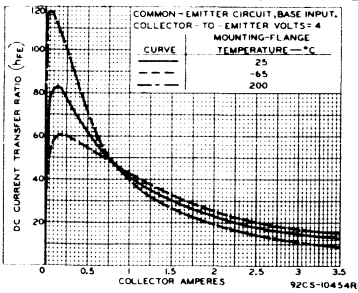


Fig. 1 - Typical dc beta characteristics for 2N1487-2N1490, and 40369.

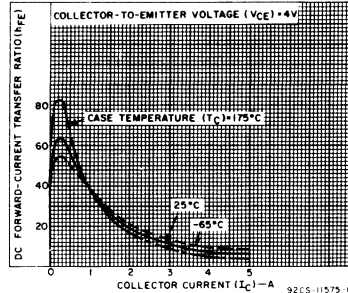


Fig. 2 - Typical dc beta characteristics for 2N1702.

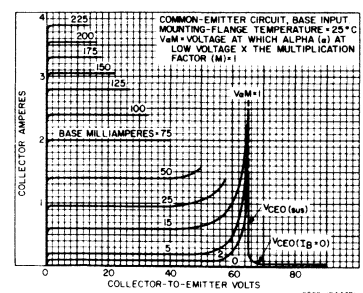


Fig. 3 - Typical output characteristics for 2N1487-2N1490, and 40369.

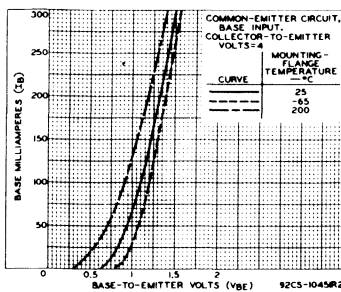


Fig. 4 - Typical input characteristics for 2N1487-2N1490, and 40369.

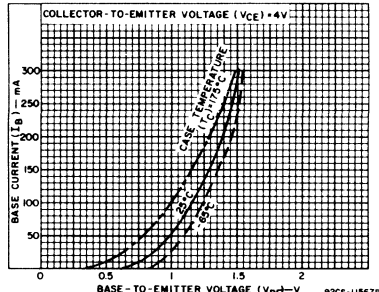


Fig. 5 - Typical input characteristics for 2N1702.

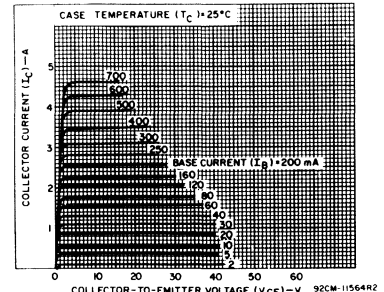


Fig. 6 - Typical output characteristics for 2N1702.

2N1487-2N1490, 2N1702, 40369

ELECTRICAL CHARACTERISTICS Mounting-flange temperature = 25°C unless otherwise specified

CHARACTERISTIC	TEST CONDITIONS					LIMITS										UNITS		
	DC COLLECTOR VOLTAGE (VOLTS)		DC EMITTER VOLTAGE (VOLTS)	DC COLLECTOR CURRENT (mA)	DC BASE CURRENT (mA)	TYPE 2N1487		TYPE 2N1488		TYPE 2N1489		TYPE 2N1490		TYPE 2N1702			TYPE 40369	
	V _{CB}	V _{CE}	V _{EB}	I _C	I _B	MIN.	MAX.	MIN.	MAX.	MIN.	MAX.	MIN.	MAX.	MIN.	MAX.		MIN.	MAX.
* I _{CBO}	30					-	25	-	25	-	25	-	25	-	200	-	10	μA
	60					-	-	-	-	-	-	-	-	-	1000	-	-	μA
	At T _C = 150°C						-	1000	-	1000	-	1000	-	1000	-	2000	-	-
* I _{EBO}			6	0		-	-	-	-	-	-	-	-	-	100	-	-	μA
I _{EBO}			10	0		-	25	-	25	-	25	-	25	-	-	-	6	μA
* V _{CEX}			1.5	0.25		60	-	100	-	60	-	100	-	-	-	-	100	V
			1.5	0.5		-	-	-	-	-	-	-	-	-	-	-	-	V
			1.5	1		-	-	-	-	-	-	-	-	60 ^b	-	-	-	V
* V _{CEO(sus)}					100	40	-	55	-	40	-	55	-	40 ^b	-	55	-	V
* h _{FE}		4			1500	15	45	15	45	25	75	25	75	-	-	25	75	
		4			800	-	-	-	-	-	-	-	-	15	60	-	-	
		20			5000	-	-	-	-	-	-	-	-	3.5	-	-	-	
* r _{CE(sat)}					1500	-	2	-	2	-	-	-	-	-	-	-	-	Ω
					1500	-	-	-	-	0.67	-	0.67	-	-	-	-	-	Ω
					800	-	-	-	-	-	-	-	-	-	4	-	-	Ω
* V _{BE}		4			1500	-	3.5	-	3.5	-	2.5	-	2.5	-	-	-	2.5	V
		4			250	-	-	-	-	-	-	-	-	-	4	-	-	V
		20			300	-	-	-	-	-	-	-	-	-	20.5	-	-	V
* V _{CE(sat)}					5000	-	-	-	-	-	-	-	-	-	20	-	-	V
* C _{ob}	40					200 (typ.)		200 (typ.)		200 (typ.)		200 (typ.)		200 (typ.)				pF
* τ _I						12 (typ.)		12 (typ.)		12 (typ.)		12 (typ.)		12 (typ.)				ms
* f _{ab}	12				100	1 (typ.)		1 (typ.)		1 (typ.)		1 (typ.)						MHz
* f _{hfb}	6				100	-	-	-	-	-	-	-	-	300				kHz
	28				0.5	-	-	-	-	-	-	-	-	1 (typ.)				MHz
t _d [•]						0.2 (typ.)		0.2 (typ.)		0.2 (typ.)		0.2 (typ.)		0.2 (typ.)				μs
t _r [•]						1 (typ.)		1 (typ.)		1 (typ.)		1 (typ.)		1 (typ.)				
t _s [•]						1 (typ.)		1 (typ.)		1 (typ.)		1 (typ.)		1 (typ.)				
t _f [•]						1.2 (typ.)		1.2 (typ.)		1.2 (typ.)		1.2 (typ.)		1.2 (typ.)				
* R _{θJC}						-	2.33	-	2.33	-	2.33	-	2.33	-	2.33	-	-	

* 2N-Series types in accordance with JEDEC registration data.

[•] I_C = 1.5 A, I_B = 300 mA, I_{B2} = -150 mA

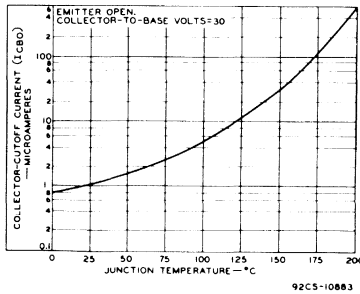


Fig. 7 - Typical collector-cutoff current characteristic for 2N1487-2N1490, and 40369.

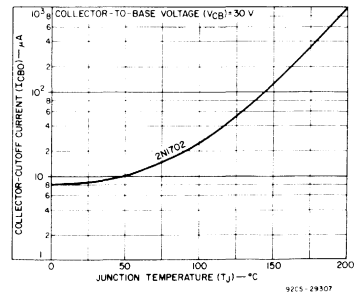


Fig. 8 - Typical collector-cutoff current characteristics for 2N1702.

2N3054, 2N6260, 2N6261, 40250, 40372, 40910, 40911

Hometaxial-Base, Medium-Power Silicon N-P-N Transistors

Rugged Devices for Intermediate-Power Applications in Industrial and Commercial Equipment

These RCA types are hometaxial-base silicon n-p-n transistors intended for a wide variety of medium- to high-power applications. Types 2N3054, 2N6260, 2N6261, and 40250 are supplied in the JEDEC TO-66 hermetic package.

Types 40250V1, 40372, 40910, and 40911 are the 40250, 2N3054, 2N6260, and 2N6061 with factory-attached heat radiators intended for printed-circuit-board applications.

Maximum Ratings, Absolute-Maximum Values:

	40250 40250V1	2N6260 40910	2N3054 40372	2N6261 40911	
* COLLECTOR-TO-BASE VOLTAGE	V _{CBO}	50	50	90	90 V
COLLECTOR-TO-EMITTER VOLTAGE:					
* With base open	V _{CEO}	40	40	55	80 V
* With external base-to-emitter resistance (R _{BE}) = 100Ω	V _{CER(sus)}	—	45	60	85 V
With base reverse-biased (V _{BE} = -1.5 V)	V _{CEV(sus)}	50	50	90	90 V
* EMITTER-TO-BASE VOLTAGE	V _{EBO}	5	5	7	7 V
* CONTINUOUS COLLECTOR CURRENT:					
At case temperature up to 25°C	I _C	4	3	4	4 A
At ambient temperatures up to 25°C	I _B	2	2	2	2 A
* TRANSISTOR DISSIPATION:	P _T	29	29	25	50 W
At case temperature up to 25°C		(40250)	(2N6260)	(2N3054)	(2N6261)
At ambient temperatures up to 25°C		5.8	5.8	5.8	5.8 W
		(40250V1)	(40910)	(40372)	(40911)
		—Derate linearly to 200°C—			
* TEMPERATURE RANGE:					
Storage & Operating (Junction)		—65 to 200 °C			
PIN TEMPERATURE (During soldering):					
At distance ≥ 1/32 in. (0.8 mm) from seating plane for 10 s max.		—235 °C			

*In accordance with JEDEC registration data format JS-9 RDF-10 (2N3054), JS-6 RDF-2 (2N6260, 2N6261)

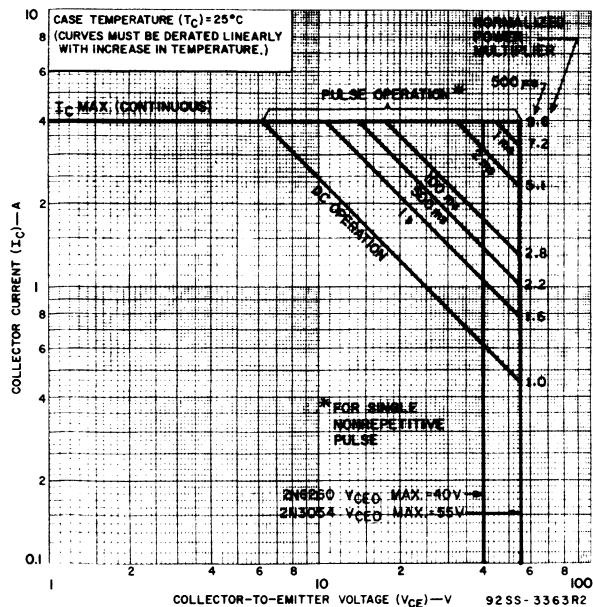


Fig. 1—Maximum operating areas for 2N3054 and 2N6260.

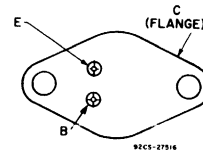
Features:

- $f_T = 800$ kHz at 0.2A (2N3064, 40372)
- Maximum safe-area-of-operation curves for dc and pulse operation
- $V_{CEV(sus)} = 90$ V min (2N3054, 2N6261)
- Low saturation voltage: $V_{CE(sat)} = 1.0$ V at $I_C = 0.5$ A (2N3054)

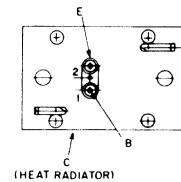
Applications:

- Power switching circuits
- Series- and shunt-regulator driver and output stages
- High-fidelity amplifiers
- Solenoid drivers.

TERMINAL DESIGNATIONS



JEDEC TO-66
2N3054, 2N6260, 2N6261, 40250



JEDEC TO-66 with Heat Radiator
40250V1, 40372, 40910, 40911

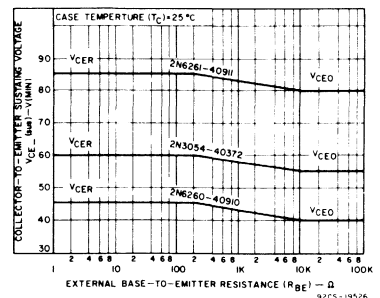


Fig. 2—Sustaining voltage vs. base-to-emitter resistance for 2N3054, 2N6260, 2N6261, 40372, 40910 and 40911.

2N3054, 2N6260, 2N6261, 40250, 40372, 40910, 40911

ELECTRICAL CHARACTERISTICS, At Case Temperature (T_C) = 25°C unless otherwise specified

CHARACTERISTIC	SYMBOL	TEST CONDITIONS				LIMITS								UNITS	
		VOLTAGE V dc		CURRENT A dc		2N6260 40910		2N3054 40372		2N6261 40911		40250 40250V1			
		VCE	VBE	IC	IB	MIN.	MAX.	MIN.	MAX.	MIN.	MAX.	MIN.	MAX.		
Collector-Cutoff Current: With base open	ICBO	VCB = 30		IE = 0		-	-	-	-	-	-	-	1	mA	
		30		0		-	1	-	0.5	-	-	-	-		
	ICEO	60		0		-	-	-	-	-	0.5	-	-		-
		40	-1.5			-	5	-	-	-	-	-	-		-
		80	-1.5			-	-	-	-	-	0.5	-	-		-
	With base-emitter junction reverse-biased	ICEV	90	-1.5			-	-	-	1.0	-	-	-		-
ICBO			VCB = 30		IE = 0		-	-	-	-	-	-	5		
			40	-1.5			-	25	-	-	-	-	-	-	
At TC = 150°C	ICEV	80	-1.5			-	-	-	-	-	1.0	-	-		
		90	-1.5			-	-	-	6.0	-	-	-	-		
Emitter-Cutoff Current	IEBO		-5 -7	0 0	- -	5 -	- -	- 1.0	- -	- 0.2	- -	- -	5	mA	
Collector-to-Base Breakdown Voltage	V(BR)ICBO			0.05	-	-	-	-	-	-	-	50	-	V	
Collector-to-Emitter Breakdown Voltage	V(BR)ICEV		-1.5	0.05	-	-	-	-	-	-	-	50	-	V	
Collector-to-Emitter Sustaining Voltage: With base open	VCE(sus)			0.1 ^a	0	40	-	55	-	80	-	40	-	V	
		With external base-to-emitter resistance (RBE) = 100Ω	VCE(sus)		0.1 ^a		45	-	60	-	85	-	-	-	
Emitter-to-Base Breakdown Voltage IE = 0.005 mA	V(BR)IEBO											5	-	V	
DC Forward Current Transfer Ratio	hFE	2		4 ^a		3	-	-	-	5	-	-	-		
		2		1.5 ^a		-	-	-	-	25	100	-	-		
		4		3 ^a		-	-	-	5	-	-	-	-		
		4		0.5 ^a		-	-	25	150	-	-	-	-		
		4		1.5 ^a		20	100	-	-	-	-	-	25	100	
Collector-to-Emitter Saturation Voltage	VCE(sat)			0.5 ^a	0.05 ^a	-	-	-	1.0	-	-	-	-	V	
				1.5 ^a	0.15 ^a	-	1.5	-	-	-	0.5	-	1.5		
				3 ^a	1 ^a	-	-	-	6.0	-	-	-	-		
Base-to-Emitter Voltage	VBE	2		1.5		-	-	-	-	-	1.5	-	-	V	
		4		1.5		-	2.2	-	-	-	-	-	2.2		
		4		0.5		-	-	-	1.7	-	-	-	-		
Common-Emitter Small-Signal Short-Circuit, Forward Current Transfer Ratio Cutoff Frequency	f _{hfe}	4		0.1		0.03	-	0.03	-	0.03	-	-	-	MHz	
Magnitude of Common-Emitter, Small-Signal, Short-Circuit Forward Current Transfer Ratio (f = 0.4 MHz)	h _{fe}	4		0.1		2	-	-	-	2	-	-	-		
Common-Emitter, Small-Signal, Short-Circuit Forward Current Transfer Ratio (f = 1 kHz)	h _{fe}	4		0.1		25		25	-	25	-	-	-		
Forward-Bias Second Breakdown Collector Current (t = 1 s)	IS/b	40				0.725	-	-	-	-	-	-	-	A	
		80				-	-	-	-	0.625	-	-	-		
		55				-	-	0.455	-	-	-	-	-		
Thermal Resistance: Junction-to-Case	RθJC					6 (max.) 2N6260		7 (max.) 2N3054		3.5 (max.) 2N6261		6 (max.) 40250		°C/W	
Junction-to-Ambient	RθJA					30 (max.) 40901		30 (max.) 40372		30 (max.) 40911		30 (max.) 40250V1			

*Pulsed: Pulse duration = 300 μs duty factor = 1.8%. *In accordance with JEDEC registration data format JS-9 RDF-10 (2N3054) JS-6 RDF-2 (2N6260-61)

2N3054, 2N6260, 2N6261, 40250, 40372, 40910, 40911

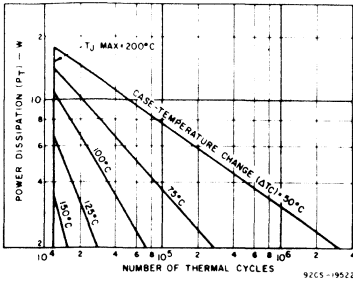


Fig. 3 - Thermal-cycling rating chart for 2N3054.

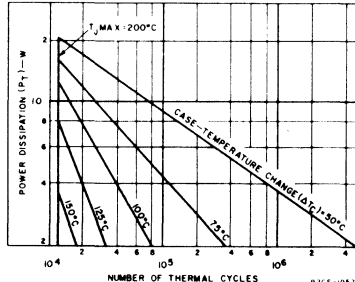


Fig. 4 - Thermal-cycling rating chart for 2N6260.

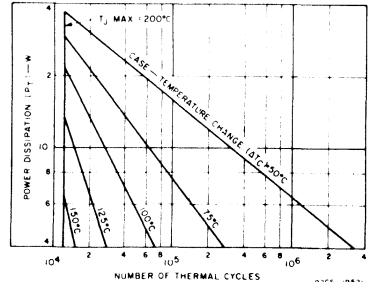


Fig. 5 - Thermal-cycling rating chart for 2N6261.

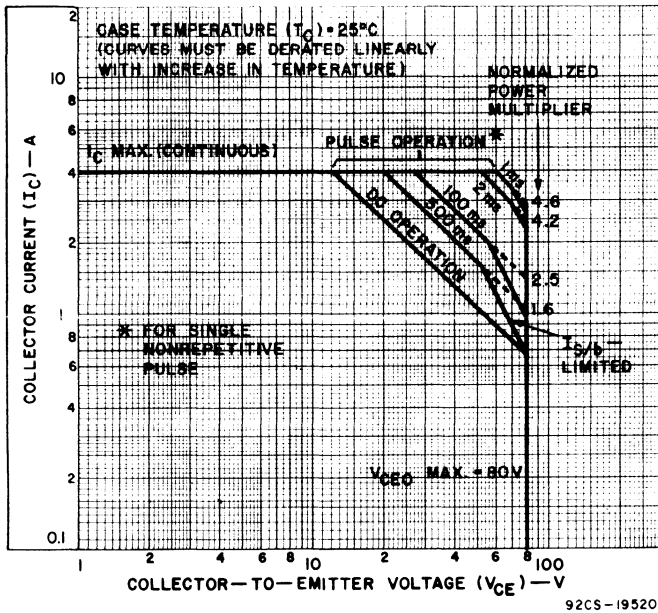


Fig. 6 - Maximum operating areas for 2N6261.

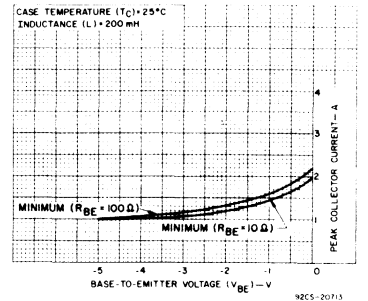


Fig. 7 - Reverse-bias second-breakdown characteristics for all types.

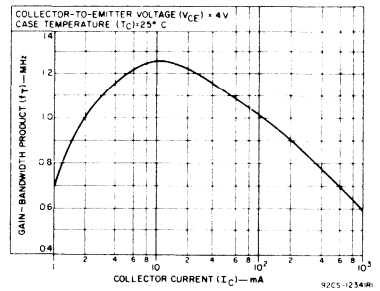


Fig. 8 - Typical gain-bandwidth product for all types.

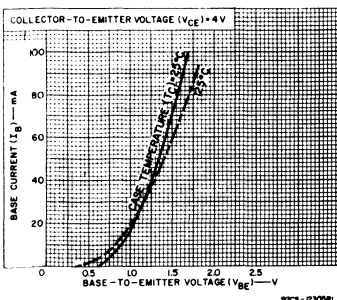


Fig. 9 - Typical input characteristics for 2N3054, 2N6260, 40250, 40250V1, 40372, and 40910.

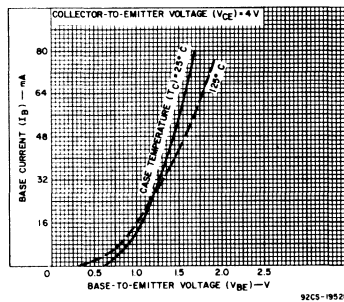


Fig. 10 - Typical input characteristics for 2N6261 and 40911.

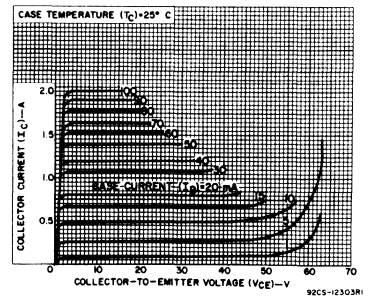


Fig. 11 - Typical output characteristics for 2N3054 and 40372.

2N3054, 2N6260, 2N6261, 40250, 40372, 40910, 40911

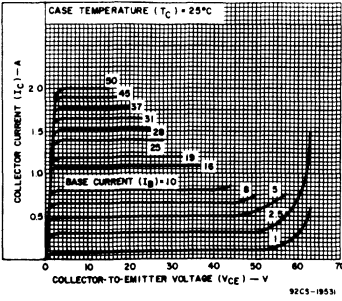


Fig. 12 - Typical output characteristics for 2N6260 and 40910.

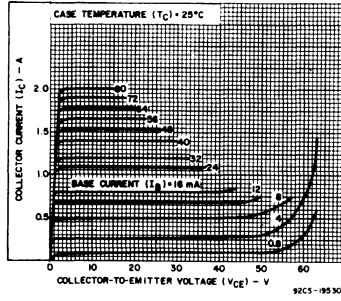


Fig. 13 - Typical output characteristics for 2N6261 and 40911.

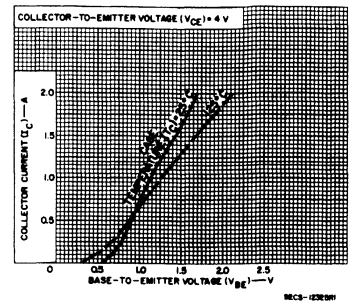


Fig. 14 - Typical transfer characteristics for 2N3054, 2N6260, 40250, 40250V1, 40372 and 40910.

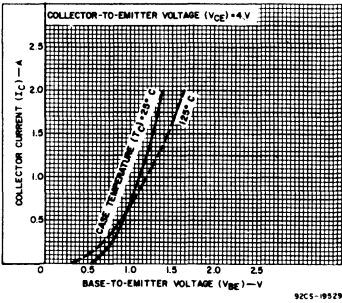


Fig. 15 - Typical transfer characteristics for 2N6261 and 40911.

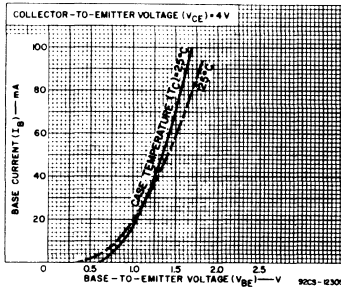


Fig. 16 - Typical input characteristics for 2N6260, 40250, 40250V1, 40372 and 40910.

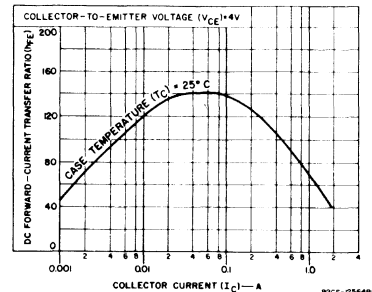


Fig. 17 - Typical dc beta characteristics for 2N6260, 40250, 40250V1 and 40910.

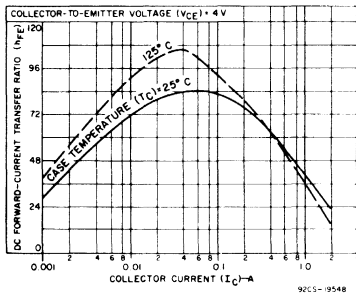


Fig. 18 - Typical dc beta characteristics for 2N6261 and 40911.

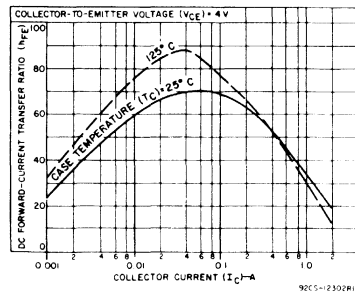


Fig. 19 - Typical dc beta characteristics for 2N3054 and 40372.

2N3055, 2N6569, RCS617, BDX18, 2N6594, RCS618, MJ2955

Silicon N-P-N and P-N-P Epitaxial-Base High-Power Transistors

Rugged, Broadly Applicable Devices For Industrial and Commercial Use

The RCA-2N6594, BDX18, MJ2955, and RCS618 are epitaxial-base silicon p-n-p transistors featuring gain at high current. The RCA-2N6569, 2N3055, and RCS617 are epitaxial-base silicon n-p-n transistors. They may be used as complements to the 2N6594, BDX18 or MJ2955, and RCS618, respectively. These devices have a dissipation capability of 100 watts (2N6569 and 2N6594), 115 watts (2N3055, BDX18, RCS617, and RCS618),

and 150 watts (MJ2955) at case temperatures up to 25°C.

They differ in voltage ratings and in the currents at which the parameters are controlled. All are supplied in the steel JEDEC TO-204MA hermetic package.

The 2N3055 is also available in a homotaxial-base version. To obtain the homotaxial-base type order the 2N3055 (Hometaxial).

Features:

- High dissipation capability
- Low saturation voltages
- Maximum safe-area-of-operation curves
- Hermetically sealed JEDEC TO-204MA package
- High gain at high current

Applications:

- Series and shunt regulators
- High-fidelity amplifiers
- Power-switching circuits
- Solenoid drivers

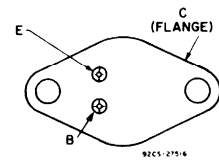
MAXIMUM RATINGS, Absolute-Maximum Values:

	N-P-N P-N-P	2N6569 2N6594*	2N3055 BDX18* MJ2955*	RCS617 RCS618*	
* V _{CBO}		45	100	100	V
V _{CER(sus)}					
R _{BE} = 100 Ω		45	70*	85	V
* V _{CEO(sus)}		40	60	80	V
* V _{EBO}		5	7	7	V
* I _C		12	15	15	A
I _{CM}		24	—	—	A
* I _B		5	7	7	A
* I _E		17	—	—	A
* P _T					W
At T _C ≤ 25°C		100	{ 150 (MJ2955) 115 (Others)	115	W
At T _C > 25°C	Derate linearly	0.572	{ 0.86 (MJ2955) 0.66 (Others)	0.66	W/°C
* T _{stg} , T _J		—65 to 200			°C
* T _L		—			°C
At distance ≥ 1/32 in. (0.8 mm) from seating plane for 10 s max.					

* 2N-types in accordance with JEDEC registration data.

♦ For p-n-p devices, voltage and current values are negative.

TERMINAL DESIGNATIONS



JEDEC TO-204MA

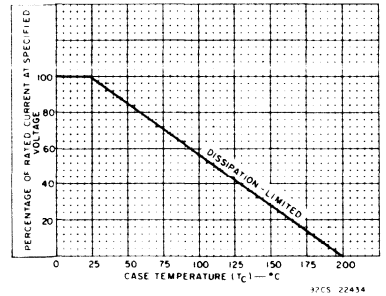


Fig. 1 — Derating curve.

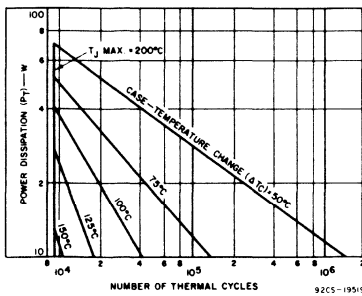


Fig. 2 — Thermal cycling rating chart for 2N6569 and 2N6594.

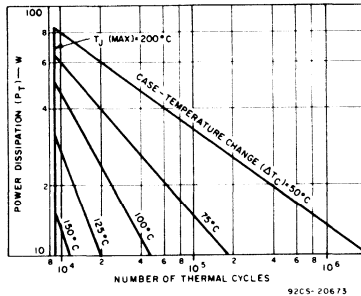


Fig. 3 — Thermal-cycling rating chart for 2N3055, BDX18, RCS617 and RCS618.

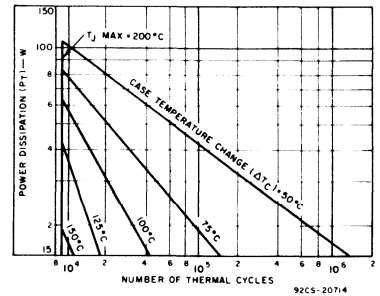


Fig. 4 — Thermal cycling rating chart for MJ2955.

♦ For p-n-p devices, voltage and current values are negative.

2N3055, 2N6569, RCS617, BDX18, 2N6594, RCS618, MJ2955

ELECTRICAL CHARACTERISTICS, at Case Temperature (T_C) = 25°C Unless Otherwise Specified

CHARACTERISTIC	TEST CONDITIONS				LIMITS						UNITS		
	VOLTAGE		CURRENT		2N6569 2N6594		2N3055 BDX18 MJ2955		RCS617 RCS618				
	V _{CE}	V _{BE}	I _C	I _B	MIN.	MAX.	MIN.	MAX.	MIN.	MAX.			
* I _{CEX}	45	-1.5			-	1	-	-	-	-		mA	
	100	-1.5			-	-	-	5	-	-			
	100	-1.5			-	-	-	1	-	-			
* I _{CEX} , T _C = 100°C	45	-1.5			-	10	-	-	-	-		mA	
	100	-1.5			-	-	-	5	-	-			
	100	-1.5			-	-	-	30	-	-			
* I _{CEX} , T _C = 150°C	100	-1.5			-	-	-	5	-	-		mA	
	100	-1.5			-	-	-	30	-	-			
	60	-1.5			-	-	-	10	-	-			
I _{CEO}	30			0	0.7		0.7*		0.7			mA	
* I _{EBO}			5	0	-	5	-	-	-	-			mA
			7	0	-	-	-	5	-	-			
			7	0	-	-	-	-	-	1			
* V _{CEO(sus)}			0.2	0	40 ^b		60 ^b		80 ^b			V	
V _{CER(sus)}			0.2	0	45 ^b		70 ^{b*}		85 ^b				
R _{BE} = 100Ω													
* h _{FE}	3		4 ^a		15	200							
	4		4 ^a				20	70					
	4		5 ^a						20	70			
	4		10 ^a				5						
Except BDX18	4		12 ^a		5	100							
V _{BE}	4		4 ^a			18*		18*				V	
	4		5 ^a							18			
* V _{BE(sat)}			4	0.55		2						V	
			4	0.4		2							
* V _{CE(sat)}			4 ^a	0.4		1.5		1.1				V	
			4 ^a	0.55		1.5							
			5 ^a	0.5						1.1			
			10 ^a	3.3				8					
2N3055 only MJ2955 only			10 ^a	3.3				3					
* f _T	2N6569 f = 0.5 MHz		4	1		1.5 2.5						MHz	
	2N3055 MJ2955		4	1				20 10					
* f _{hfe}	2N3055 f = 10 kHz		4	1				20 10				kHz	
	MJ2955 (only)		4	0.5				2.5 4		2.5			
h _{fe}	f = 1 kHz		4	1		15		15*	20*	15			
I _{S/b}	t _p = 1 s nonrep.		40			2.5		2.87		2.87			
* C _{obo}	V _{CB} = 10 V, f = 1 MHz					75	750					pF	
t _d	V _{CC} = 30 V			2	0.2		0.4						
t _i	I _{B1} = I _{B2}			2	0.2		1.5					μs	
t _s				2	0.2		5						
t _f				2	0.2		1.5						
R _{θJC}	2N3055, BDX18 MJ2955						1.75*		1.5			°C/W	
									1.17				

♦ For p-n-p devices, voltage and current values are negative.
 • 2N types in accordance with JEDEC registration data.
 • Pulsed; pulse duration = 300 μs, duty factor = 1.8%.

CAUTION: Sustaining voltages V_{CEO(sus)} and V_{CER(sus)} MUST NOT be measured on a curve tracer.

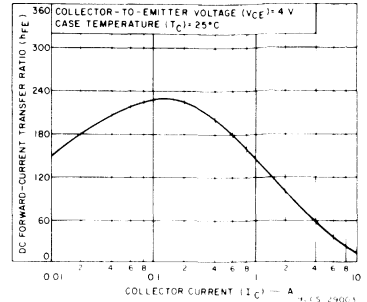


Fig. 5 — Typical dc beta characteristics. ♦

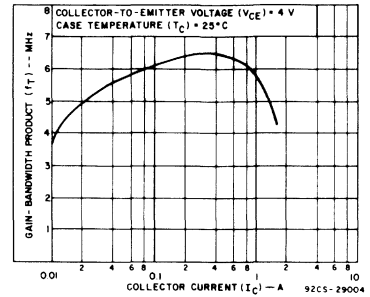


Fig. 6 — Typical gain-bandwidth product. ♦

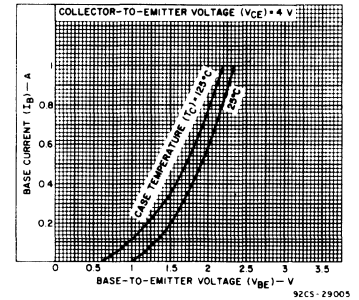


Fig. 7 — Typical input characteristics. ♦

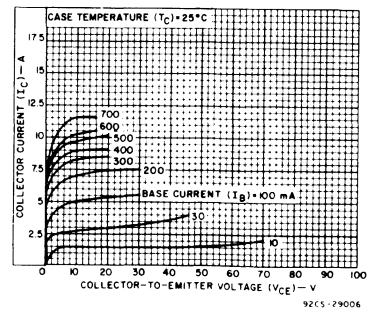


Fig. 8 — Typical output characteristics. ♦

♦ For p-n-p devices, voltage and current values are negative.

2N3055, 2N6569, RCS617, BDX18, 2N6594, RCS618, MJ2955

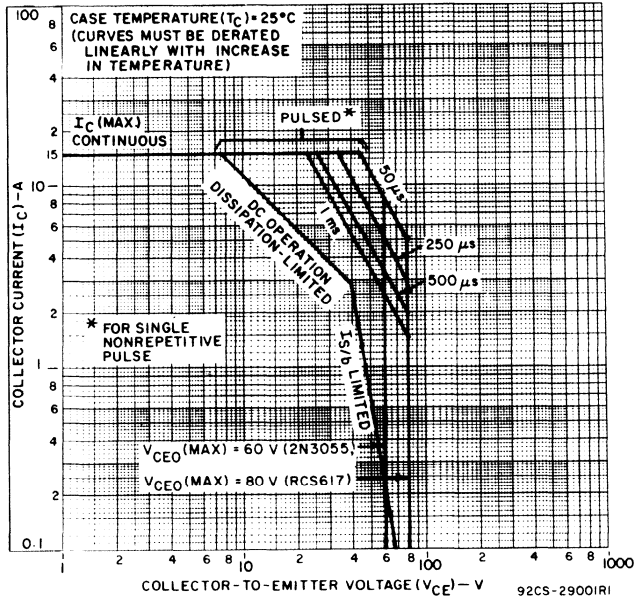


Fig. 9 — Maximum operating areas for 2N3055 and RCS617.

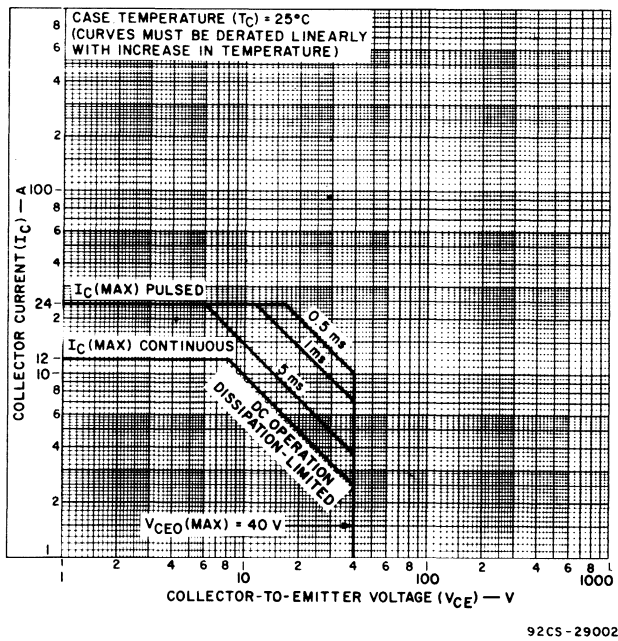


Fig. 10 — Maximum operating areas for 2N6569 and 2N6594.*

* For p-n-p devices, voltage and current values are negative.

2N3055, 2N6569, RCS617, BDX18, 2N6594, RCS618, MJ2955

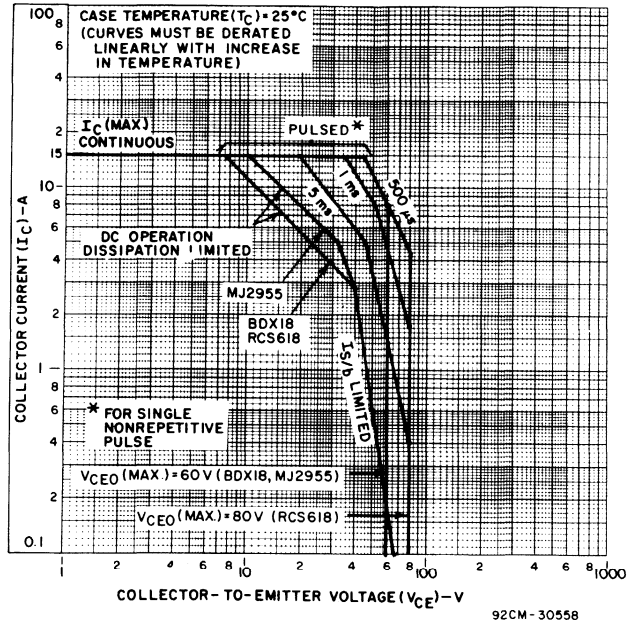


Fig. 11 — Maximum operating areas for BDX18, MJ2955 and RCS618. ♦

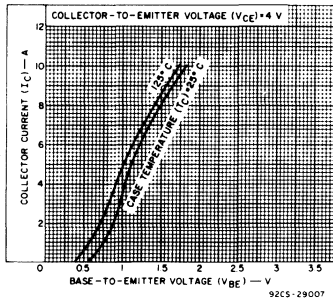


Fig. 12 — Typical transfer characteristics. ♦

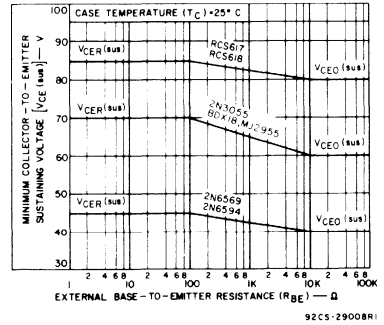


Fig. 13 — Sustaining voltage vs. base-to-emitter resistance. ♦

♦For p-n-p devices, voltage and current values are negative.

2N3055 (Hometaxial), 2N6253, 2N6254, 2N6371, 40251

Hometaxial-Base High-Power Silicon N-P-N Transistors

Rugged, Broadly Applicable Devices
For Industrial and Commercial Use

The RCA-2N3055 (Hometaxial)*, 2N6253, 2N6254 and 2N6371 are silicon n-p-n transistors intended for a wide variety of high-power applications. The hometaxial-base construction of these devices renders them highly resistant to second breakdown over a wide range of operating conditions.

These devices differ in maximum ratings for voltage and power dissipation. All are sup-

plied in JEDEC TO-204MA hermetic steel packages.

The 2N3055 is also available in an epitaxial-base version. To obtain the hometaxial-base type described in this data sheet, order the 2N3055 (Hometaxial).

*Formerly 2N3055H.

Features:

- 2N6254: premium type from 2N3055 (Hometaxial) family
- Maximum safe-area-of-operation curves
- Low saturation voltages
- High dissipation capability
- Thermal-cycling rating curves

Applications:

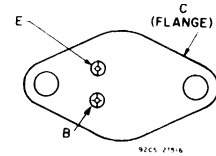
- Series and shunt regulators
- High-fidelity amplifiers
- Power-switching circuits
- Solenoid drivers
- Low-frequency inverters

MAXIMUM RATINGS, Absolute-Maximum Values:

	2N3055 (Hometaxial)	2N6253	2N6254	2N6371	40251	
* V_{CBO}	100	55	100	50	50	V
* $V_{CER(sus)}$						
$R_{BE} = 100 \Omega$	70	55	85	45	—	V
* $V_{CEO(sus)}$	60	45	80	40	40	V
$V_{CEV(sus)}$						
$V_{BE} = -1.5 V$	90	55	90	50	50	V
* V_{EBO}	7	5	7	5	5	V
* I_C	15	15	15	15	15	A
* I_B	7	7	7	7	7	A
* P_T						
$\leq 25^\circ C$		115	115	150	117	W
$> 25^\circ C$		Derate linearly to $200^\circ C$				
* $T_{J, T_{stg}}$			-65 to +200			$^\circ C$
* T_L : During soldering, at distances 1/32 in. (0.8 mm) from seating plane for 10 s max.			235			$^\circ C$

*In accordance with JEDEC registration data formats JS-9 RDF-10; 2N3055 (Hometaxial)
JS-6 RDF-2; 2N6253, 2N6254, 2N6371.

TERMINAL DESIGNATIONS



JEDEC TO-204MA

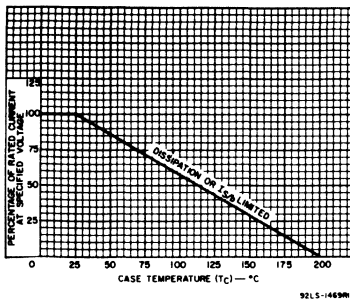


Fig. 1 — Current derating curve for all types.

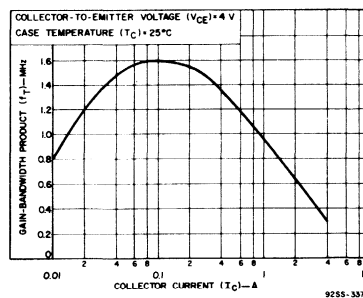


Fig. 2 — Typical gain-bandwidth product for all types.

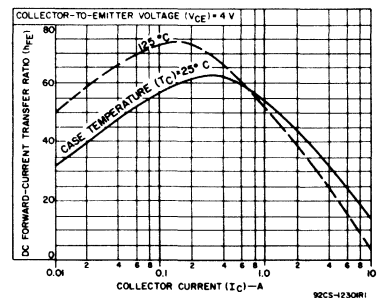


Fig. 3 — Typical dc-beta characteristics for 2N3055 (Hometaxial) and 2N6371.

2N3055 (Hometaxial), 2N6253, 2N6254, 2N6371, 40251

ELECTRICAL CHARACTERISTICS, $T_C = 25^\circ\text{C}$ Unless Otherwise Specified.

CHARACTERISTIC	TEST CONDITIONS				LIMITS								UNITS		
	VOLTAGE		CURRENT		2N3055 (Hometaxial)		2N6253		2N6254		2N6371			40251	
	V _{dc}	V _{dc}	A _{dc}	A _{dc}	MIN.	MAX.	MIN.	MAX.	MIN.	MAX.	MIN.	MAX.		MIN.	MAX.
I _{CEO}	25			0	-	-	-	1.5	-	-	-	1.5	-	-	mA
	30			0	-	0.7	-	-	-	-	-	-	-	-	
	60			0	-	-	-	-	1	-	-	-	-		
I _{CEX}	40	-1.5			-	-	-	-	-	-	-	-	-	2	mA
	45	-1.5			-	-	-	-	-	-	2	-	-	-	
	55	-1.5			-	-	-	2	-	-	-	-	-	-	
	100	-1.5			-	5	-	-	0.5	-	-	-	-	-	
T _C = 150°C	40	-1.5			-	-	-	-	-	-	10	-	10	-	
	50	-1.5			-	-	-	10	-	-	-	-	-		
	100	-1.5			-	30	-	-	5	-	-	-	-		
I _{EBO}		-5			-	-	-	10	-	-	-	-	-	mA	
		-7			-	5	-	-	0.5	-	-	-	-		
V(BR)ICBO			0.1		-	-	-	-	-	-	-	-	50	V	
V(BR)ICEV		-1.5	0.1		-	-	-	-	-	-	-	-	50	V	
V(BR)EBO I _E = 0.01 mA			0		-	-	-	-	-	-	-	-	5	V	
V _{CEO} (sus)			0.2 ^a	0	60	-	45	-	80	-	40	-	40	V	
V _{CER} (sus) R _{BE} = 100 Ω			0.2 ^a		70	-	55	-	85	-	45	-	-		
V _{CEV} (sus)		-1.5	0.1 ^a		90	-	55	-	90	-	50	-	-		
h _{FE}	4		3 ^a		-	-	20	70	-	-	-	-	-	-	
	4		4 ^a	20	70	-	-	-	-	-	-	-	-		
	2		5 ^a		-	-	-	-	20	70	-	-	-		
	4		8 ^a		-	-	-	-	-	-	15	60	15		60
	4		10 ^a	5	-	-	-	-	-	-	-	-	-		-
	4		15 ^a		-	-	3	-	5	-	-	-	-		-
	4		16 ^a		-	-	-	-	-	-	4	-	-		-
V _{BE}	4		3 ^a		-	-	-	1.7	-	-	-	-	-	V	
	4		4 ^a		1.8	-	-	-	-	-	-	-	-		
	2		5 ^a		-	-	-	-	1.5	-	-	-	-		
	4		8 ^a		-	-	-	-	-	-	-	-	2.2		
	4		16 ^a		-	-	-	-	-	-	4	-	-		
V _{CE} (sat)			3 ^a	0.3 ^a	-	-	-	1	-	-	-	-	-	V	
			4 ^a	0.4 ^a	-	1.1	-	-	-	-	-	-	-		
			5 ^a	0.5 ^a	-	-	-	-	0.5	-	-	-	-		
			8 ^a	0.8 ^a	-	-	-	-	-	-	1.5	-	1.5		
			10 ^a	3.3 ^a	-	8	-	-	-	-	-	-	-		
			15 ^a	3 ^a	-	-	-	-	4	-	-	-	-		
			15 ^a	5 ^a	-	-	-	4	-	-	-	-	-		
		16 ^a	4 ^a	-	-	-	-	-	-	4	-	-			
h _{fe} f = 1 kHz	4		1		15	120	10	-	10	-	10	-	-		
f _T			1		800	-	-	-	-	-	800	-	-	kHz	
h _{fe} l f = 0.4 MHz	4		1		-	-	2	-	2	-	2	-	-		
f _{hfe}	4		1		10	-	10	-	10	-	-	-	-	kHz	
I _S /b t _p = 1 s nonrep.	39				-	-	-	-	-	-	-	-	3	A	
	40				2.9	-	-	-	-	-	2.9	-	-		
	45				-	-	2.55	-	-	-	-	-	-		
	60				1.95	-	-	-	-	-	-	-	-		
	80				-	-	-	-	1.87	-	-	-	-		
R _θ JC					-	1.5	-	1.5	-	1.17	-	1.5	-	1.5	°C/W

* In accordance with JEDEC registration data formats JS-9 RDF-10: 2N3055H; JS-6 RDF-2: 2N6253, 2N6254, 2N6371.

^a Pulsed: Pulse duration = 300 μs, duty factor = 1.8%.

2N3055 (Hometaxial), 2N6253, 2N6254, 2N6371, 40251

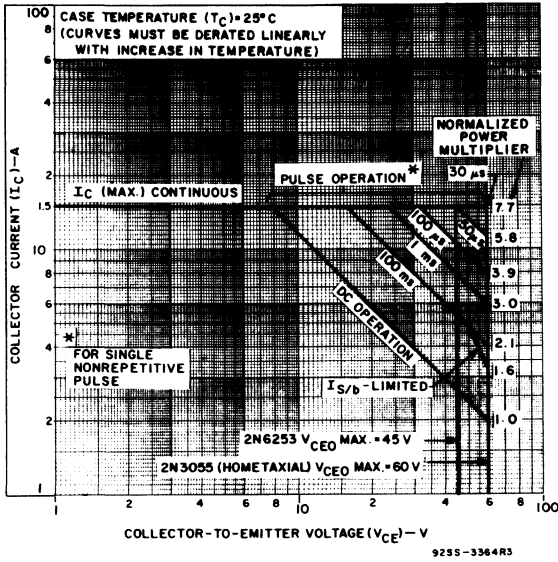


Fig. 4 - Maximum operating areas for 2N6253 and 2N3055 (Hometaxial).

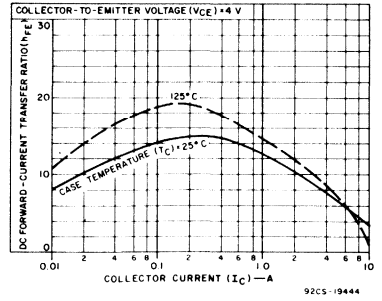


Fig. 5 - Typical dc-beta characteristics for 2N6253.

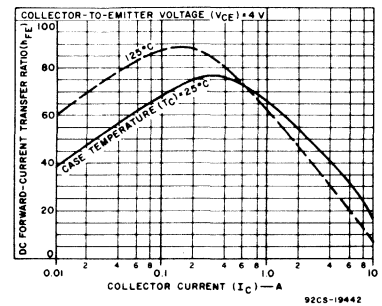


Fig. 6 - Typical dc-beta characteristics for 2N6254.

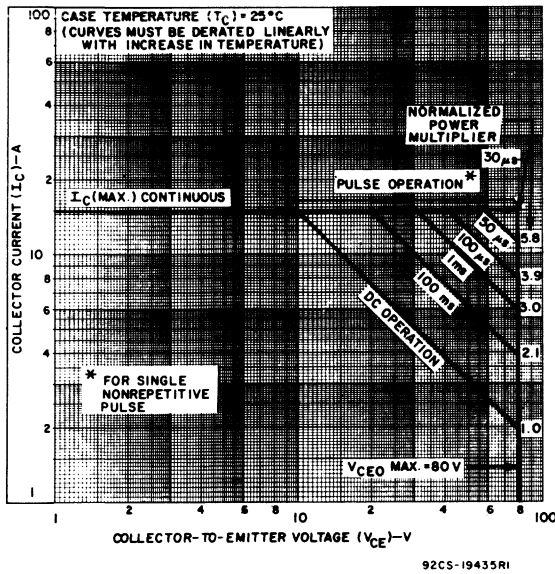


Fig. 7 - Maximum operating areas for 2N6254.

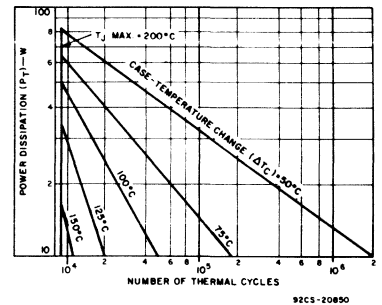


Fig. 8 - Thermal-cycling rating chart for 2N3055 (Hometaxial), 2N6253 and 2N6371.

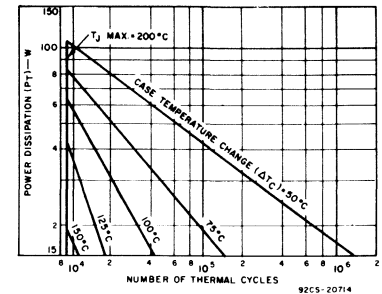


Fig. 9 - Thermal-cycling rating chart for 2N6254.

2N3055 (Hometaxial), 2N6253, 2N6254, 2N6371, 40251

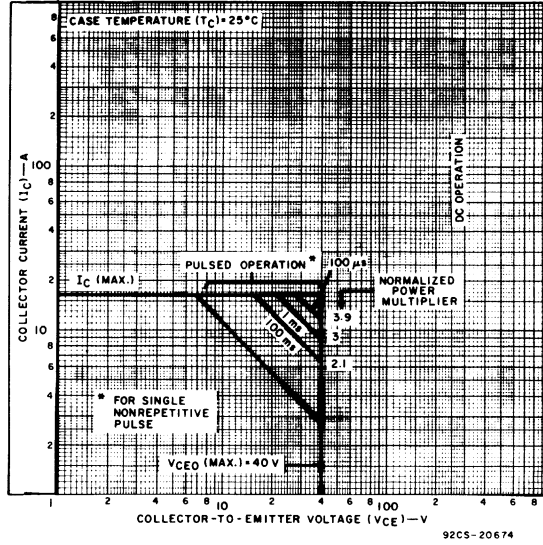


Fig. 10 -- Maximum safe-area-of-operation at case temperature of 25°C for 2N6371.

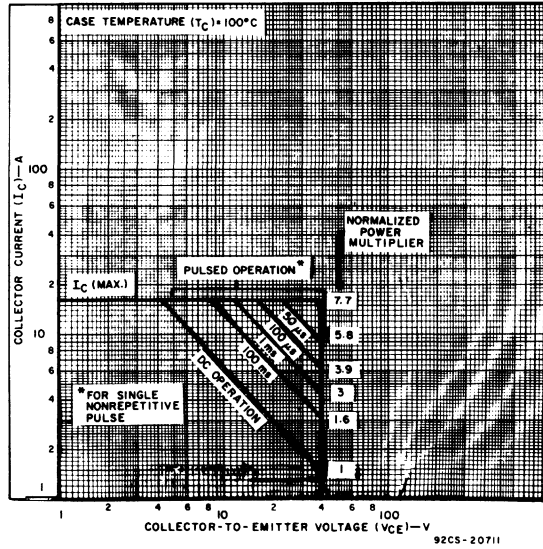


Fig. 11 -- Maximum safe-area-of-operation at case temperature of 100°C for 2N6371.

2N3055 (Hometaxial), 2N6253, 2N6254, 2N6371, 40251

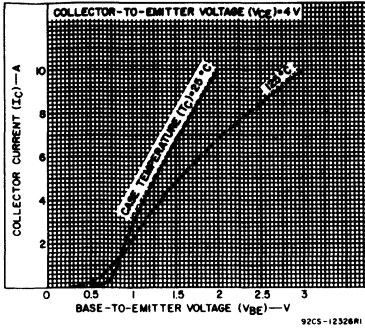


Fig. 12 - Typical transfer characteristics for 2N6253, 2N3055 (Hometaxial), 2N6371 and 40251.

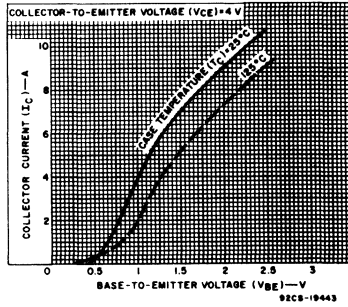


Fig. 13 - Typical transfer characteristics for 2N6254.

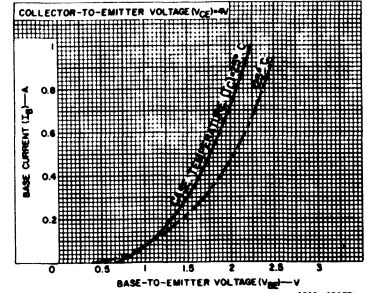


Fig. 14 - Typical input characteristics for 2N3055 (Hometaxial), 2N6371 and 40251.

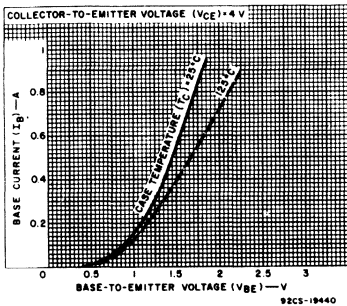


Fig. 15 - Typical input characteristics for 2N6253.

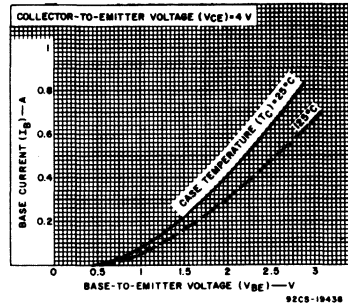


Fig. 16 - Typical input characteristics for 2N6254.

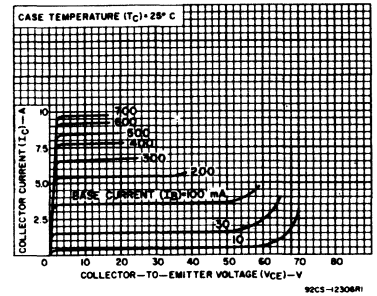


Fig. 17 - Typical output characteristics for 2N3055 (Hometaxial) and 2N6371.

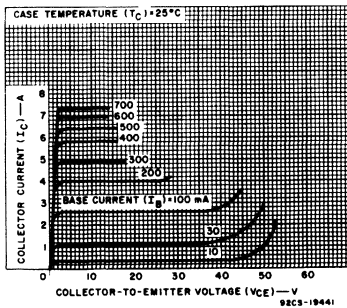


Fig. 18 - Typical output characteristics for 2N6253.

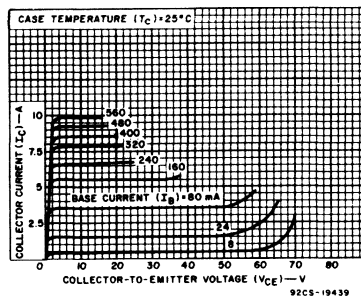


Fig. 19 - Typical output characteristics for 2N6254.

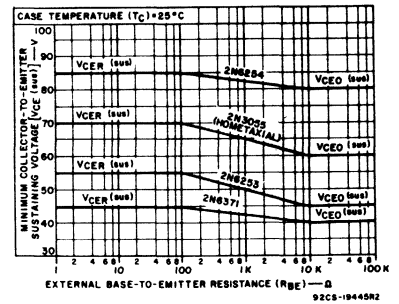


Fig. 20 - Sustaining voltage vs. base-to-emitter resistance for all types.

2N3263-2N3266

High-Power, High-Speed, High-Current Silicon N-P-N Power Transistors

Epitaxial Types for Aerospace, Military, and Industrial Applications

RCA-2N3263, 2N3264, 2N3265, and 2N3266* are n-p-n epitaxial silicon power transistors designed for high-reliability aerospace, military, and industrial equipment. Their high current-handling capability and fast switching speed make them desirable in applications where high circuit efficiency is required.

The 2N3263 and 2N3264 are sealed in flat 3/4-inch-diameter packages with radial leads. Types 2N3265 and 2N3266 utilize the JEDEC TO-63 package.

Typical high-speed switching applications for these transistors include switching-control amplifiers, power gates, switching regulators, dc-dc converters, and dc-ac inverters. Other recommended applications include dc-rf amplifiers and power oscillators.

* Formerly RCA Dev. Nos. TA2492, TA2493, TA2494, and TA2495, respectively.

MAXIMUM RATINGS, Absolute-Maximum Values:

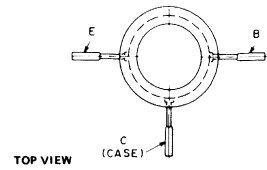
	2N3264 2N3266	2N3263 2N3265	
* COLLECTOR-TO-BASE VOLTAGE	VCBO	120	150
COLLECTOR-TO-EMITTER SUSTAINING VOLTAGE:			
With 1.5 volts (V_{BE}) of reverse bias	VCEX(sus)	120	150
With external base-to-emitter resistance (R_{BE}) $\leq 50 \Omega$	VCEX(sus)	80	110
* With base open	VCEO (sus)	60	90
* EMITTER-TO-BASE VOLTAGE	VEBO	7	7
* COLLECTOR CURRENT	IC	25	25
* BASE CURRENT	IB	10	10
* TRANSISTOR DISSIPATION	PT	See Figs. 1 & 2	
* TEMPERATURE RANGE:			
Storage and operating (Junction)		-65 to +200	°C
LEAD TEMPERATURE (During soldering):			
At distance $\geq 1/32$ in. (0.8 mm) from seating plane for 10 s max.		230	°C

* In accordance with JEDEC registration data format.

Features:

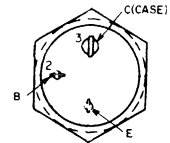
- Low saturation voltages —
2N3263 and 2N3265
 $V_{CE}(sat) = 0.75 \text{ V (max.) at } I_C = 15 \text{ A}$
 $V_{BE}(sat) = 1.60 \text{ V (max.) at } I_C = 15 \text{ A}$
2N3264 and 2N3266
 $V_{CE}(sat) = 1.20 \text{ V (max.) at } I_C = 15 \text{ A}$
 $V_{BE}(sat) = 1.80 \text{ V (max.) at } I_C = 15 \text{ A}$
- High reliability and uniformity of characteristics
- High power dissipation
- Fast rise time at high collector current —
0.2 μs at 10 A (typical)

TERMINAL DESIGNATIONS



92CS-27523

2N3263, 2N3264 (RADIAL)



TOP VIEW

92CS-25530

2N3265, 2N3266 (JEDEC TO-63)

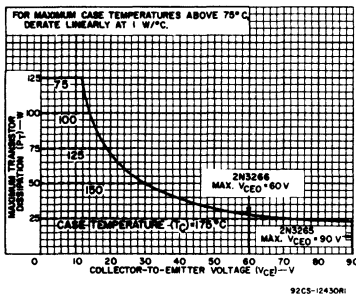


Fig. 1—Rating chart for 2N3265 and 2N3266.

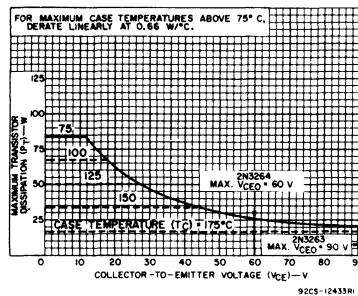


Fig. 2—Rating chart for 2N3263 and 2N3264.

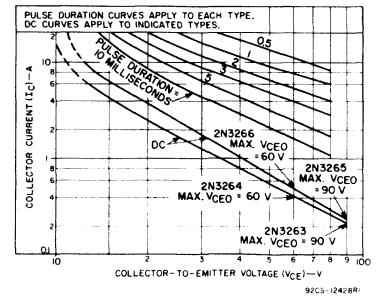


Fig. 3—Safe operating region as a function of pulse width.

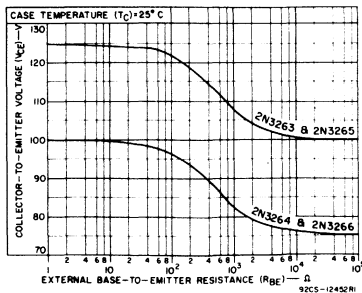


Fig. 4—Typical sustaining voltage vs. base-to-emitter resistance.

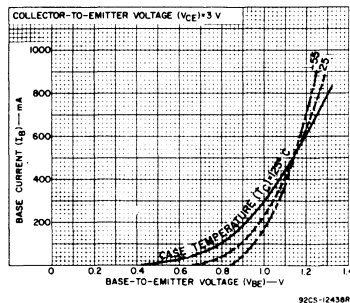


Fig. 5—Typical input characteristics.

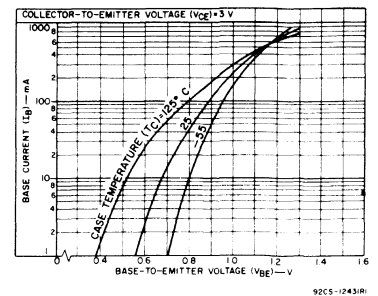


Fig. 6—Typical input characteristics.

2N3263-2N3266

ELECTRICAL CHARACTERISTICS, At Case Temperature (T_C) = 25°C unless otherwise specified

CHARACTERISTIC	SYMBOL	TEST CONDITIONS						LIMITS				UNITS		
		VOLTAGE V dc			CURRENT A dc			2N3264 2N3266		2N3263 2N3265				
		V _{CB}	V _{CE}	V _{EB}	I _E	I _B	I _C	MIN.	MAX.	MIN.	MAX.			
Collector Cutoff Current: With emitter open At $T_C = 125^\circ\text{C}$	I _{CBO}	80			0			-	10	-	-		mA	
With base reverse-biased	I _{CEX}	80			0			-	10	-	4			
Emitter Cutoff Current: At $T_C = 125^\circ\text{C}$	I _{EBO}			7			0	-	15	-	5		mA	
Emitter-to-Base Voltage	V _{EBO}			7			0	-	15	-	5			
Collector-to-Emitter Sustaining Voltage: With base open	V _{CEO(sus)} *					0.02	0	7	-	7	-		V	
With external base-to-emitter resistance ($R_{BE} \leq 50 \Omega$)	V _{CER(sus)} *						0	0.2	80	-	80			
Collector-to-Emitter Saturation Voltage	V _{CE(sat)} *						2	20	-	1.6	-	1	V	
Base-to-Emitter Saturation Voltage	V _{BE(sat)} *						1.2	15	-	1.2	-	0.75		
DC Forward Current Transfer Ratio	h _{FE} *						5	35	-	40	-		mA	
Second-Breakdown Collector Current: (See Fig. 3) DC forward-biased	I _{S/b} ^A	50	75				15	20	-	80	-	25		75
							15	15	-	20	-	55		
Pulsed, forward-biased, $t_p = 250 \mu\text{s}$		75					13.3	-	13.3	-			A	
Second-Breakdown Energy With base reverse-biased, and $R_{BE} = 20 \Omega, L = 40 \mu\text{H}$	E _{S/b} **			6			10	2	-	2	-		mJ	
Saturated Switching Time:	t _{ON}						1.2 ^B	15	-	0.5	-	0.5		μs
Turn-on ($t_d + t_r$)	t _s						1.2 ^B	15	-	1.5	-	1.5		
Storage	t _f						1.2 ^B	15	-	0.5	-	0.5		
Gain-Bandwidth Product (f = 1 MHz)	f _T		10				3	20	-	20	-		MHz	
Collector-to-Base Feedback Capacitance (f = 1 MHz)	C _{ob}		10		0			-	500	-	500			
Thermal Resistance (Junction-to-Case)	R _{θJC}												°C/W	
							10							

* In accordance with JEDEC registration data format.
 * Pulsed; pulse duration $\leq 380 \mu\text{s}$, duty factor $\leq 2\%$. CAUTION: The sustaining voltages V_{CEO(sus)} and V_{CER(sus)} MUST NOT be measured on a curve tracer. These sustaining voltages should be measured by means of test circuit.
^A I_{S/b} is defined as the current at which second breakdown occurs at a specified collector voltage.
^B E_{S/b} is defined as the energy at which second breakdown occurs under specified reverse bias conditions. $E_{S/b} = 1/2 I_L^2$, where L is a series load or leakage inductance and I is the collector current.
^C I_{B1} = I_{B2}

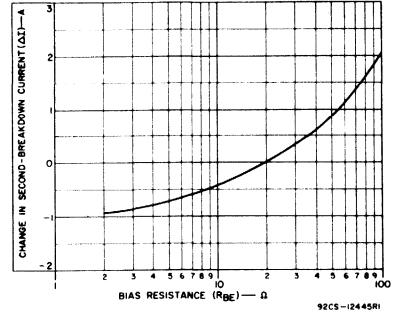


Fig. 7—Typical change in $E_{S/b}$ as a function of base-to-emitter resistance.

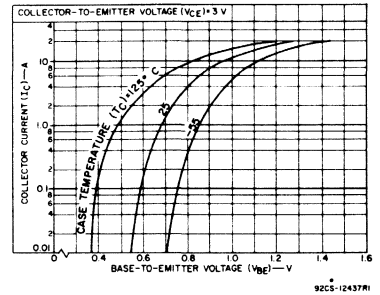


Fig. 8—Typical transfer characteristics.

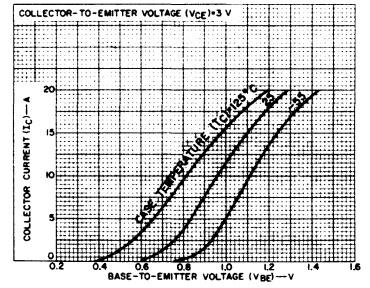


Fig. 9—Typical transfer characteristics.

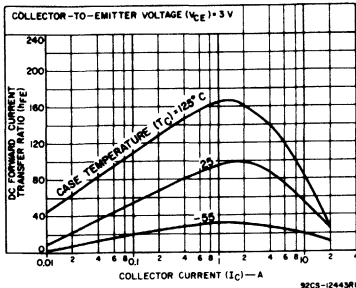


Fig. 10—Typical dc beta characteristics (median values).

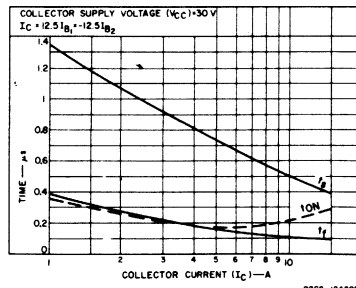


Fig. 11—Typical saturated-switching characteristics.

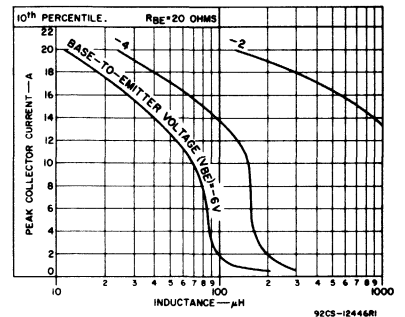


Fig. 12—Collector current as a function of inductance (50th percentile).

2N3439; 2N3440; 2N4063; 2N4064; 40385; 40346, V1, V2; 40390; 40412, V1, V2

High-Voltage Silicon N-P-N Transistors

For High-Speed Switching and Linear-Amplifier Applications

These RCA types are epitaxial-base silicon n-p-n transistors with high breakdown voltages, high-frequency response, and fast switching speeds. These transistors are intended for industrial, commercial, and military equipment. Typical applications include high-voltage differential and operational amplifiers, high-voltage inverters, and high-voltage, low-current switching and series regulators.

Types 40346, 40346V1, and 40346V2 are especially useful in such devices as neon

indicator and NIXIE[®] driver circuits and in differential and operational amplifiers. Types 40412, 40412V1, and 40412V2 are especially suited for class-A ac/dc audio-amplifier service.

These transistors are supplied in JEDEC TO-39 hermetic packages or in the TO-39 package with factory-attached mounting flange or heat radiator.

•Nixie is a Registered Trademark of Burroughs Corporation, Electronic Components Division, Plainfield, N.J.

	2N3439 2N4063 40385	2N3440 2N4064 40390	40346 40346V1 40346V2	40412 40412V1 40412V2	
MAXIMUM RATINGS, Absolute-Maximum Values:					
*COLLECTOR-TO-BASE VOLTAGE V_{CB0}	450	300	—	—	V
COLLECTOR-TO-EMITTER VOLTAGE:					
With external base-to-emitter resistance (R_{BE}) = 1,000 Ω $V_{CE}^{(sus)}$	—	—	175	—	V
= 10,000 Ω $V_{CE}^{(sus)}$	—	—	—	250	V
* With base open $V_{CEO}^{(sus)}$	350	250	—	—	V
*EMITTER-TO-BASE VOLTAGE V_{EBO}	7	7	—	—	V
*CONTINUOUS COLLECTOR CURRENT I_C	1	1	1	1	A
*CONTINUOUS BASE CURRENT I_B	0.5	0.5	0.5	0.5	A
TRANSISTOR DISSIPATION: P_T					
At case temperature up to 25°C	10	10(2N3440)	10(40346)	10(40412)	W
At free-air temperatures up to 25°C	1(40385)	3.5(40390)	4(40346V1)	4(40412V1)	W
At free-air temperatures up to 50°C	1(2N3439)	1(2N3440)	1(40346)	1(40412)	W
At free-air temperatures above 25°C or 50°C					Derate linearly to 200°C °C
*TEMPERATURE RANGE:					
Storage & Operating (Junction)					-65 to 200 °C
*LEAD TEMPERATURE (During soldering):					
At distances $\geq 1/32$ in (0.79 mm) from seating plane for 10 s max.					255 °C

*2N Series types in accordance with JEDEC registration data
NOTE: P_T value of 10 W at $T_C = 25^\circ\text{C}$ and lead temperature of 255°C are registered data for 2N4063 and 2N4064 only

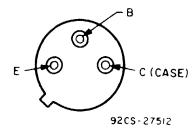
Features:

- High voltage ratings:
 $V_{CB0} = 450$ V max. (2N3439, 2N4063)
 $= 300$ V max. (2N3440, 2N4064)
 $V_{CEO}^{(sus)} = 350$ V max. (2N3439, 2N4063)
 $= 250$ V max. (2N3440, 2N4064)
- Maximum-area-of-operation curves
- Low saturation voltages
- Planar construction for low noise and low leakage

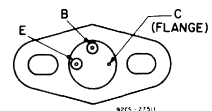
Additional Features for 40385:

- High reliability assured by five preconditioning steps
- Group A test data in data File 215

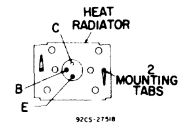
TERMINAL DESIGNATIONS



JEDEC TO-39
2N3439, 2N3440, 40346
40385, 40412



JEDEC TO-39 with Flange
2N4063, 2N4064, 40346V2,
40412V2



JEDEC TO-39 with Heat Radiator
40390, 40346V1, 40412V1

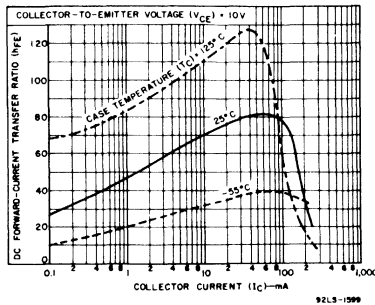


Fig. 1 — Typical dc-beta characteristics for 2N3439, 2N3440, 2N4063, 2N4064 and 40390.

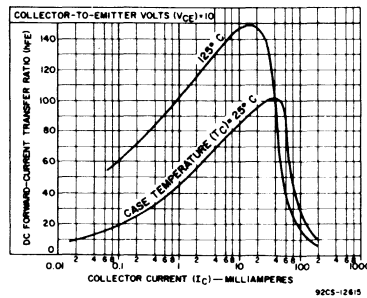


Fig. 2 — Typical dc-beta characteristics for 40346, 40346V1, 40346V2, 40412, 40412V1 and 40412V2.

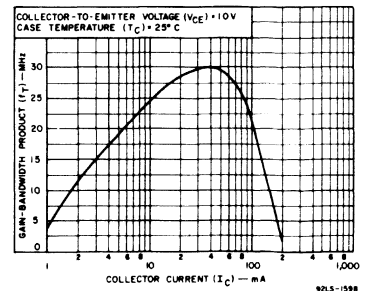


Fig. 3 — Typical gain-bandwidth product for all types.

**2N3439; 2N3440; 2N4063; 2N4064; 40385;
40346, V1, V2; 40390; 40412, V1, V2**
ELECTRICAL CHARACTERISTICS, Case Temperature (T_C) = 25°C, Unless Otherwise Specified

CHARACTERISTICS	SYMBOL	VOLTAGE		CURRENT	LIMITS								UNITS
		V dc			mA dc	2N3439 2N4063 40385		2N3440 2N4064 40390		40346 40346V1 40346V2		40412 40412V1 40412V2	
		V_{CE}	V_{BE}	I_C		MIN.	MAX.	MIN.	MAX.	MIN.	MAX.	MIN.	
Collector-Cutoff Current: With base open	I_{CEO}	100 200 300	—		—	—	—	—	—	5	—	5	μA
With base reverse-biased:	I_{CEV}	200 300 450	— 1.5 — 1.5 — 1.5		—	—	—	500	—	10	—	—	
At $T_C = 150^\circ C$		150 200	— 1.5 — 1.5		—	—	—	—	—	—	—	2	mA
With R = 10,000 ohms	I_{CER}	100			—	—	—	—	—	—	—	1	mA
* Collector-Cutoff Current	I_{CBO}	250 360	—		—	20 ^c	—	20 ^c	—	—	—	—	μA
* Emitter-Cutoff Current	I_{EBO}		— 3 — 4 — 6		—	—	—	—	—	—	—	100	μA
DC Forward-Current Transfer Ratio	h_{FE}	10 10 10 20		2 10 20 30	30 — 40 —	— — 160 —	— — 40 —	— — 160 —	— 25 — —	— — — —	— — — 40	—	
Collector-to-Emitter Sustaining Voltage: With base open	$V_{CEO(sus)}$			50	350 ^a	—	250 ^a	—	—	—	—	—	V
Collector-to-Emitter Sustaining Voltage: With external base-to- emitter resistance $R_{BE} = 1,000$ ohms $R_{BE} = 10,000$ ohms	$V_{CER(sus)}$ $V_{CER(sus)}$			50 50	— —	— —	— —	— —	175 ^a —	— —	— 250 ^a	— —	V
Base-to-Emitter Voltage	V_{BE}	10		10	—	—	—	—	—	1	—	—	V
* Base-to-Emitter Saturation Voltage $I_B = 4$ mA	$V_{BE(sat)}$			50	—	1.3	—	1.3	—	—	—	—	V
Collector-to-Emitter Saturation Voltage $I_B = 1$ mA $I_B = 4$ mA	$V_{CE(sat)}$			10 50	— —	— 0.5	— —	— 0.5	— —	0.5 —	— —	0.5 —	V
* Small-Signal Forward- Current Transfer Ratio: f = 5 MHz	h_{fe}	10		10	3	—	3	—	2	—	2	—	
* Output Capacitance: $V_{CB} = 10$ V, f = 1 MHz	C_{ob}				—	10	—	10	—	10	—	10	pF
Second-Breakdown Current $t_p = 0.4$ s	$I_{S/b}$	200			—	50 ^b	—	50 ^b	—	—	50	—	mA
Thermal Resistance: Junction-to-case	$R_{\theta JC}$				—	17.5	—	17.5	15 max. (40346) (40346V2)	15 max. (40412) (40412V2)	—	—	$^\circ C/W$
Junction-to-free air	$R_{\theta JFA}$				—	—	—	—	45 max. (40346V1)	45 max. (40412V1)	—	—	

^aCAUTION: The sustaining voltages, $V_{CEO(sus)}$ and $V_{CER(sus)}$, MUST NOT be measured on a curve tracer.

^b2N-Series types.

^c2N3439 and 2N3440 only.

^{*}2N-Series types in accordance with JEDEC registration data.

2N3439; 2N3440; 2N4063; 2N4064; 40385;
40346, V1, V2; 40390; 40412, V1, V2

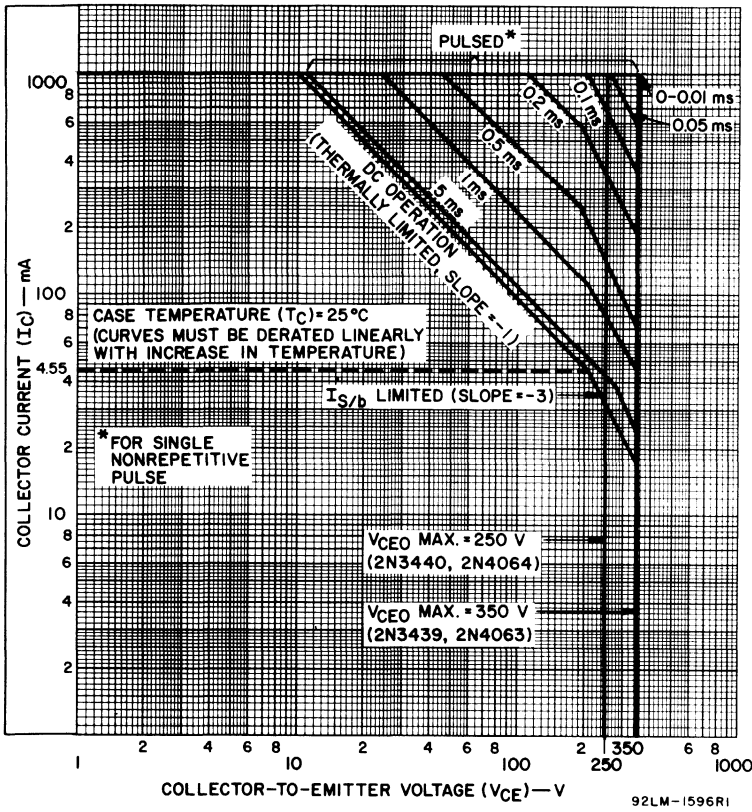


Fig. 4—Maximum operating areas for 2N3439, 2N3440, 2N4063 and 2N4064.

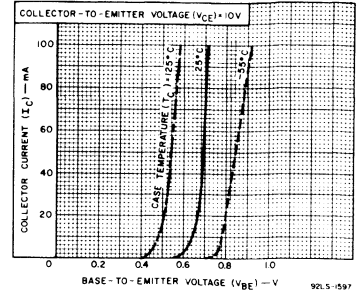


Fig. 5—Typical transfer characteristics for 2N3439, 2N3440, 2N4063, 2N4064 and 40390.

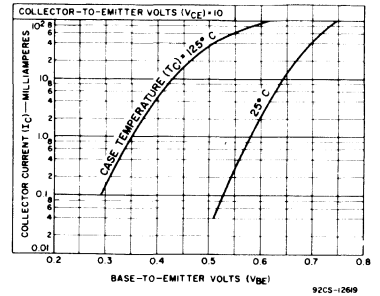


Fig. 6—Typical transfer characteristics for 40346, 40346V1, 40346V2, 40412, 40412V1 and 40412V2.

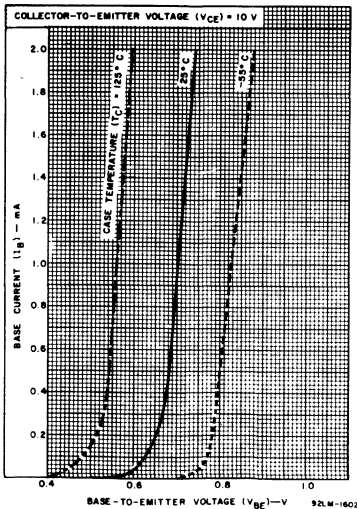


Fig. 8—Typical input characteristics for 2N3439, 2N3440, 2N4063, 2N4064 and 40390.

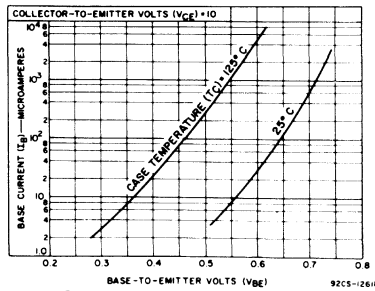


Fig. 9—Typical input characteristics for 40346, 40346V1, 40346V2, 40412, 40412V1 and 40412V2.

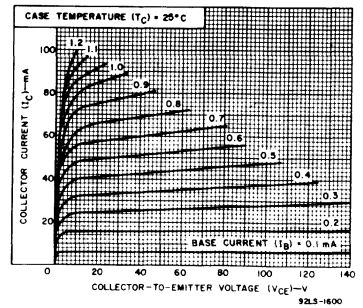


Fig. 7—Typical output characteristics for 2N3439, 2N3440, 2N4063, 2N4064 and 40390.

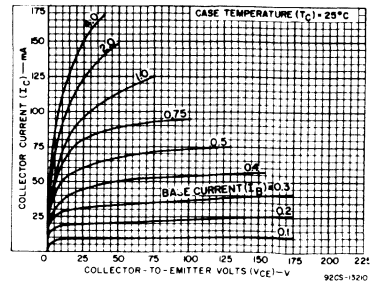


Fig. 10—Typical output characteristics for 40346, 40346V1, 40346V2, 40412, 40412V1 and 40412V2.

2N3441, 2N6263, 2N6264, 40373, 40912, 40913

Hometaxial-Base, Medium-Power Silicon N-P-N Transistors

Rugged Devices for Intermediate Power Applications in Industrial and Commercial Equipment

RCA 2N3441, 2N6263, and 2N6264 are hometaxial-base silicon n-p-n transistors intended for a wide variety of medium-to-high power, high-voltage applications. These types are supplied in the JEDEC TO-66 hermetic package.

Types 40373, 40912, and 40913 are the 2N3441, 2N6263, and 2N6264 with factory-attached heat-radiators intended for printed-circuit-board applications.

Features:

- 2N6264: premium type from 2N3441 family
- Maximum safe-area-of-operation curves for dc and pulse operation
- High voltage ratings
- Low saturation voltages
- Thermal-cycling rating curves

Applications:

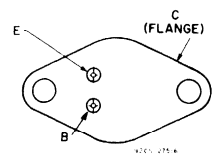
- Series and shunt regulators
- High-fidelity amplifiers
- Power switching circuits
- Solenoid drivers

MAXIMUM RATINGS, Absolute-Maximum Values:

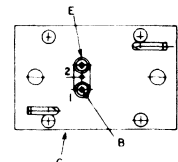
	2N6263 40912	2N3441 40373	2N6264 40913	
*COLLECTOR-TO-BASE VOLTAGE	140	160	170	V
COLLECTOR-TO-EMITTER SUSTAINING VOLTAGE:				
• With base open	V _{CE0(sus)} 120	140	150	V
• With external base-to-emitter resistance (R _{BE}) = 100Ω	V _{CEB(sus)} 130	150	160	V
• With base reverse-biased (V _{BE} = -1.5 V)	V _{CEV(sus)} 140	160	170	V
*EMITTER-TO-BASE VOLTAGE	V _{EB0} 7	7	7	V
*CONTINUOUS COLLECTOR CURRENT	I _C 3	3	3	A
PEAK COLLECTOR CURRENT	4	4	4	A
*CONTINUOUS BASE CURRENT	I _B 2	2	2	A
TRANSISTOR DISSIPATION:				
• At case temperature up to 25°C	P _T 20	25	50	W
• At ambient temperatures up to 25°C	(2N6263) 5.8	(2N3441) 5.8	(2N6264) 5.8	W
• At temperatures above 25°C	(40912) 5.8	(40373) 5.8	(40913) 5.8	W
*TEMPERATURE RANGE	Derate linearly to 200°C			°C
• Storage & Operating (Junction)	-65 to 200			°C
*PIN TEMPERATURE (During Soldering):	236			°C
• At distances ≥ 1/32 in. (0.8 mm) from seating plane for 10 s max.				

*In accordance with JEDEC registration data format JS-6 PDF-2

TERMINAL DESIGNATIONS



JEDEC TO-66
2N3441, 2N6263, 2N6264



JEDEC TO-66 with Heat Radiator
40373, 40912, 40913

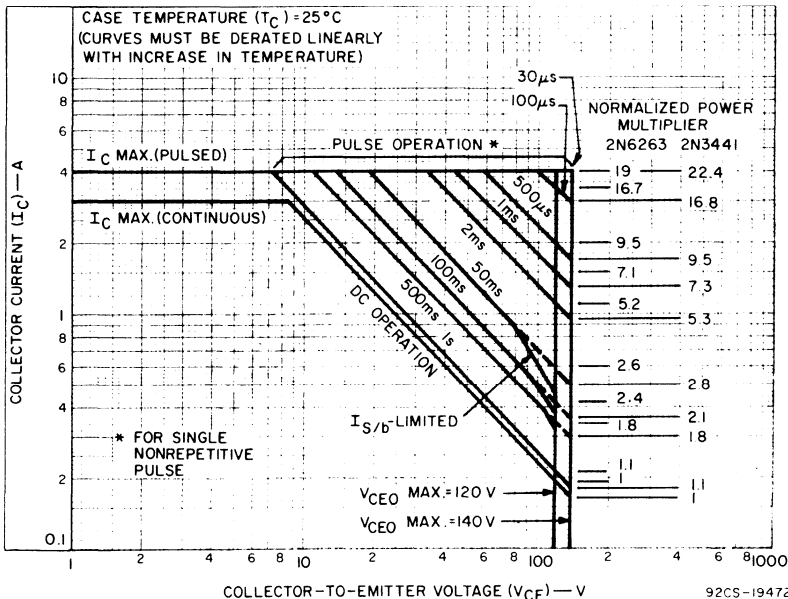


Fig. 1—Maximum operating areas for 2N3441 and 2N6263.

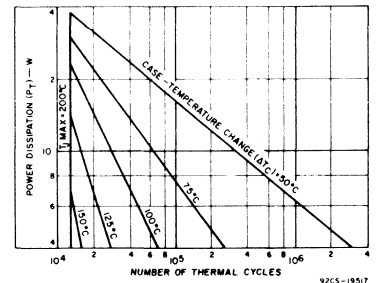


Fig. 2—Thermal-cycle rating chart for 2N6264.

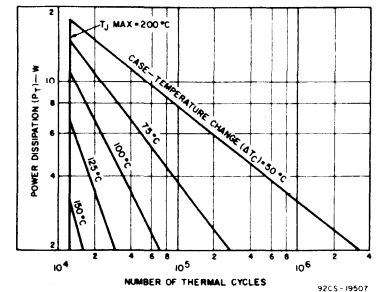


Fig. 3—Thermal-cycle rating chart for 2N3441.

2N3441, 2N6263, 2N6264, 40373, 40912, 40913

ELECTRICAL CHARACTERISTICS, At Case Temperature (T_C) = 25°C, Unless Otherwise Specified

CHARACTERISTIC	SYMBOL	TEST CONDITIONS				LIMITS						UNITS
		VOLTAGE V _{dc}		CURRENT A _{dc}		2N6263 40912		2N3441 40373		2N6264 40913		
		V _{CE}	V _{BE}	I _C	I _B	Min.	Max.	Min.	Max.	Min.	Max.	
Collector-Cutoff Current:												
• With base open	I _{CEO}	100 130 140		0 0 0		5			100		1	mA
Collector-Cutoff Current:												
	I _{CEX}	120 140 140 150	1.5 1.5 1.5 1.5			2*		5* 1			0.05*	mA
With base-emitter junction reversed biased	I _{CEX} (T _C = 150°C)	120 140 140 150	1.5 1.5 1.5 1.5			10*		6* 5			1*	mA
• Emitter-Cutoff Current	I _{EBO}		-5 -7			2		1			0.2	mA
Collector-to-Emitter Sustaining Voltage: ^a	V _{CEO(sus)}			0.1 ^b	0	120		140		150		
With external base-to-emitter resistance (R _{BE}) = 100 Ω	V _{CER(sus)}			0.1		130		150		160		V
With base-emitter junction reversed biased	V _{CEV(sus)}		1.5	0.1		140		160		170		V
• DC Forward-Current Transfer Ratio	h _{FE}	2 2 4 4		1 ^b 3 ^b 0.5 ^b 2.7 ^b		3 20 100		25 100		20 5	60	
Collector-to-Emitter Saturating Voltage	V _{CE(sat)}			0.5 ^b 1 ^b 2.7 ^b	0.05 0.1 0.9		1.2*	1		6*	0.5*	V
Base-to-Emitter Voltage	V _{BE}	2 4 4		1 ^b 0.5 ^b 2.7 ^b			2*	1.7 6*			1.5*	V
• Magnitude of Common-Emitter, Small-Signal, Short-Circuit Forward Current Transfer Ratio (f = 0.4 MHz)	h _{fe}	4		0.5		5		5		5		
Gain-Bandwidth Product	f _T	4		0.2		200		200		200		kHz
• Common-Emitter, Small-Signal, Short-Circuit Forward Current Transfer Ratio (f = 1 kHz)	h _{fe}	4 4		0.1 0.5		25 -		- 15 75		25 -		
Forward-Bias Second Breakdown Collector Current, Pulse Duration (non-repetitive) = 1 s	I _{S/b}	120 120 120				0.167 - -		- - 0.21		- - -	0.417	A
Thermal Resistance:												
Junction-to-Case	R _{θJC}					8.75 (max.) 2N6263		7 (max.) 2N3441		3.5 (max.) 2N6264		°C/W
Junction-to-Ambient	R _{θJA}					30 (max.) 40912		30 (max.) 40373		30 (max.) 40913		

*In accordance with JEDEC registration data format (JS-6 RDF-2).

^aCAUTION: The sustaining voltage V_{CEO(sus)}, V_{CER(sus)}, and V_{CEV(sus)} MUST NOT be measured on a curve tracer.^bPulsed, pulse duration = 300 μs; duty factor ≤ 2%.

2N3441, 2N6263, 2N6264, 40373, 40912, 40913

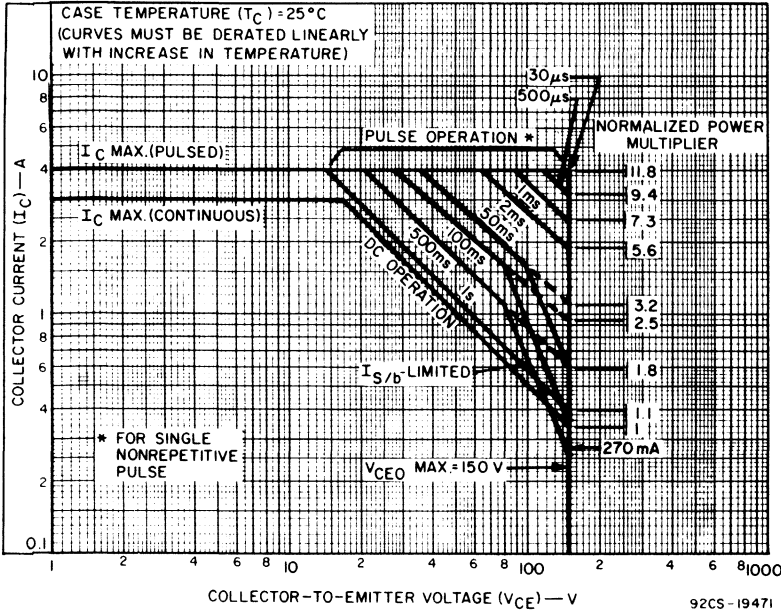


Fig. 4 – Maximum operating areas for 2N6264.

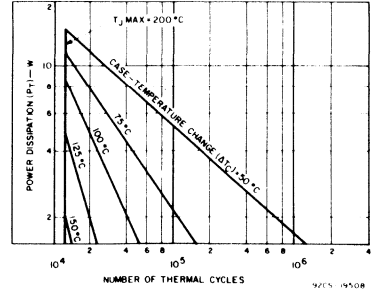


Fig. 5 – Thermal-cycle rating chart for 2N6263.

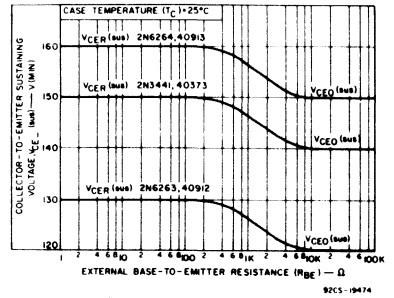


Fig. 6 – Sustaining voltage vs. base-to-emitter resistance for all types.

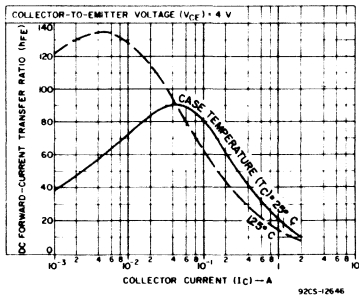


Fig. 7 – Typical dc-beta characteristics for 2N3441 and 40373.

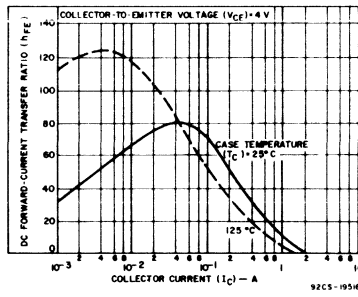


Fig. 8 – Typical dc-beta characteristics for 2N6263 and 40912.

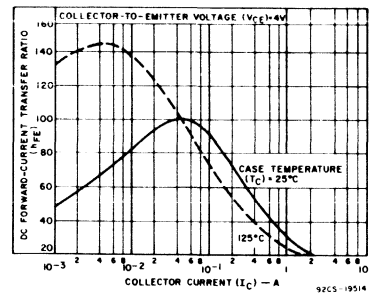


Fig. 9 – Typical dc-beta characteristics for 2N6264 and 40913.

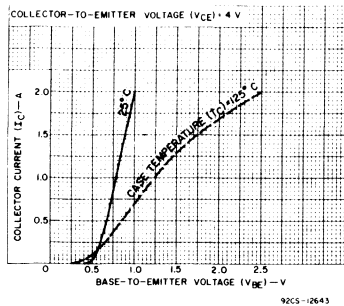


Fig. 10 – Typical transfer characteristics for 2N3441 and 40373.

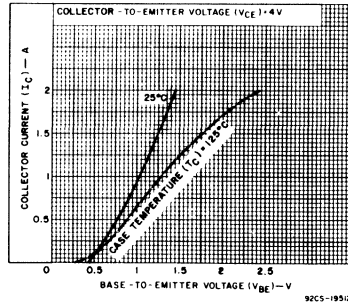


Fig. 11 – Typical transfer characteristics for 2N6263 and 40912.

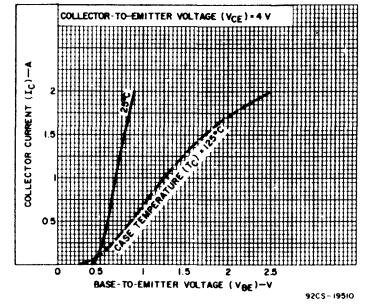


Fig. 12 – Typical transfer characteristics for 2N6264 and 40913.

2N3441, 2N6263, 2N6264, 40373, 40912, 40913

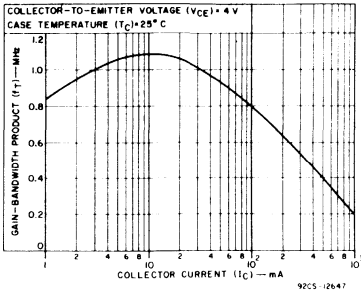


Fig. 13—Typical gain-bandwidth product for all types.

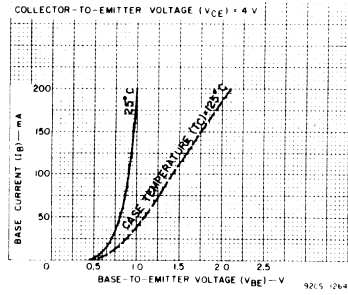


Fig. 14—Typical input characteristics for 2N3441 and 40373.

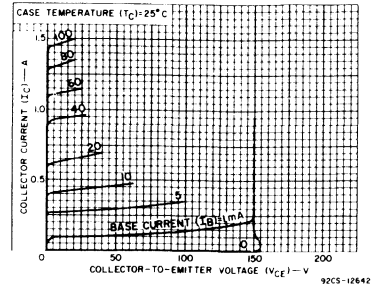


Fig. 15—Typical output characteristics for 2N3441 and 40373.

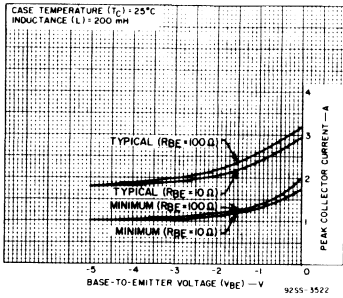


Fig. 16—Reverse-bias second-breakdown characteristics for all types.

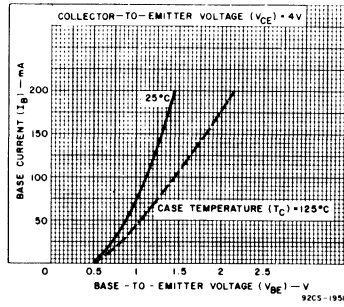


Fig. 17—Typical input characteristics for 2N6263 and 40912.

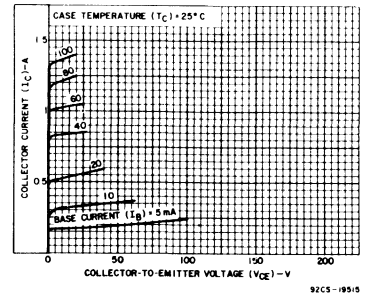


Fig. 18—Typical output characteristics for 2N6263 and 40912.

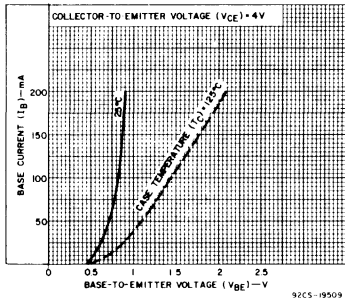


Fig. 19—Typical input characteristics for 2N6264 and 40913.

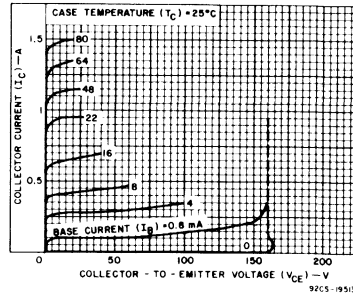


Fig. 20—Typical output characteristics for 2N6264 and 40913.

2N3442, 2N4347, 2N6262

Hometaxial-Base High-Voltage Silicon N-P-N Transistors

Rugged High-Power Devices for Applications in Industrial and Commercial Equipment

RCA 2N3442, 2N4347, and 2N6262 are hometaxial-base, silicon n-p-n transistors intended for a wide variety of high-power, high-voltage applications. Typical applications for these transistors include power-switching circuits, audio amplifiers, series- and shunt-regulator driver and output stages, dc-to-dc converters, inverters, and solenoid (hammer)/relay driver service.

These devices employ the popular JEDEC TO-3 package; they differ in maximum ratings for voltage, current, and power.

Features:

- Low saturation voltages
- Thermal-cycle rating charts
- High dissipation capability — 100 W (2N4347)
— 117 W (2N3442)
— 150 W (2N6262)

■ Maximum area-of-operation curves for dc and pulse operation.

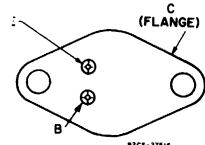
Applications:

- Series and shunt regulators
- High-fidelity amplifiers
- Power-switching circuits

MAXIMUM RATINGS, Absolute-Maximum Values:

	2N4347	2N3442	2N6262	
*COLLECTOR-TO-BASE VOLTAGE	140	160	170	V
COLLECTOR-TO-EMITTER VOLTAGE:				
• With base open	120	140	150	V
With reverse bias (V_{BE}) of -1.5 V	140*	160	170	V
*EMITTER-TO-BASE VOLTAGE	7	7	7	V
*COLLECTOR CURRENT:				
Continuous	5	10	10	A
Peak	10*	15	15	A
*BASE CURRENT:				
Continuous	3	7	7	A
Peak	8*	—	—	A
*TRANSISTOR DISSIPATION:				
At case temperature up to 25°C	100	117	150	W
At case temperatures above 25°C	Derate linearly to 200°C			
*TEMPERATURE RANGE:				
Storage & Operating (Junction)	— 65 to $+200$ —			$^{\circ}\text{C}$
*PIN TEMPERATURE (During Soldering):				
At distances $\geq 1/32$ in. (0.8 mm) from case for 10 s max.	235	235	235	$^{\circ}\text{C}$

TERMINAL DESIGNATIONS



JEDEC TO-3

*In accordance with JEDEC registration data format (JS-6, RDF-2).

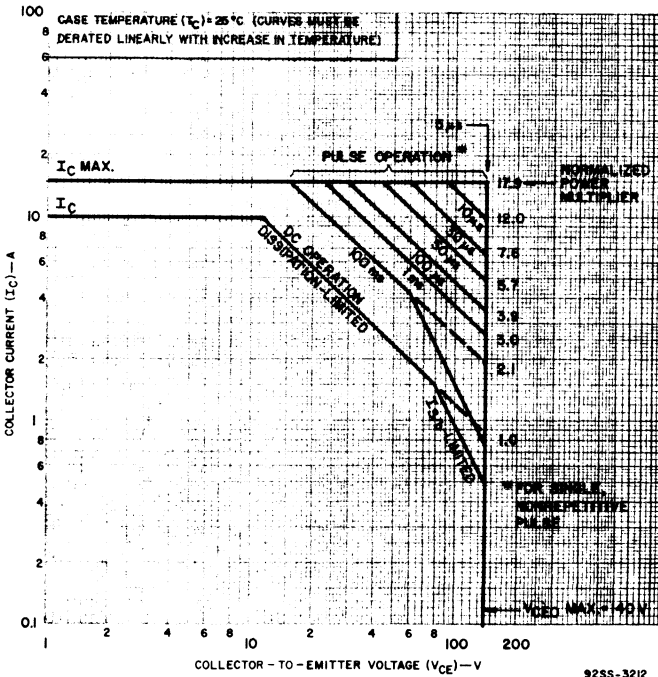


Fig. 1—Maximum operating areas for 2N3442.

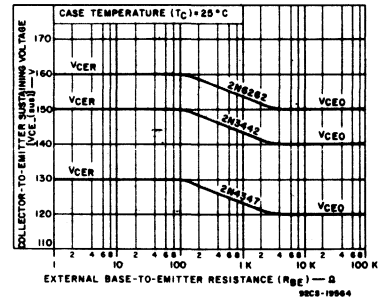


Fig. 2—Sustaining voltage vs. base-to-emitter resistance for all types.

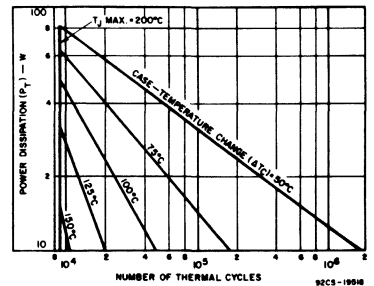


Fig. 3—Thermal-cycle rating chart for 2N3442.

2N3442, 2N4347, 2N6262

ELECTRICAL CHARACTERISTICS, At Case Temperature (T_C) = 25°C unless otherwise specified

CHARACTERISTIC	SYMBOL	TEST CONDITIONS				LIMITS						UNITS
		VOLTAGE		CURRENT		2N4347		2N3442		2N6262		
		V dc		A dc		Min.	Max.	Min.	Max.	Min.	Max.	
		V _{CE}	V _{BE}	I _C	I _B							
Collector Cutoff Current: With emitter open (V _{CB} = 140 V)	I _{CBO}					-	-	-	1*	-	1	mA
* With base-emitter junction reverse-biased	I _{CEX}	120	-1.5			-	2	-	-	-	-	mA
		140	-1.5			-	-	-	5	-	-	
		140	-1.5			-	-	-	1	-	-	
		150	-1.5			-	-	-	-	-	0.1	
* With base-emitter junction reverse-biased and T _C = 150°C	I _{CEX}	125	-1.5			-	10	-	-	-	-	mA
		140	-1.5			-	-	-	30	-	-	
		140	-1.5			-	-	-	10	-	-	
		150	-1.5			-	-	-	-	-	2	
* With base open	I _{CEO}	100				-	200	-	-	-	-	mA
		110				-	-	-	-	-	1	
		140				-	-	-	200	-	-	
* Emitter Cutoff Current	I _{EBO}		-7	0		-	5	-	5	-	0.2	mA
* DC Forward Current Transfer Ratio	h _{FE}	2		3 ^a		-	-	-	-	20	70	
		2		10 ^a		-	-	-	-	5	-	
		4		2 ^a		15	60	-	-	-	-	
		4		3 ^a		-	-	20	70	-	-	
		4		5 ^a		10	-	-	-	-	-	
Collector-to-Emitter Sustaining Voltage: With base-emitter junction reverse- biased	V _{CEV(sus)}		-1.5	0.1		140	-	160	-	-	-	V
			-1.5	0.2		-	-	-	-	170	-	
	V _{CEr(sus)}			0.1		130	-	-	-	-	-	V
* With external base-to-emitter resistance (R _{BE}) = 100Ω				0.2		-	-	150	-	160	-	V
* With base open	V _{CEO(sus)}			0.2 ^a	0	120	-	140	-	-	-	V
				0.2 ^a	0	-	-	-	-	150	-	V
* Base-to-Emitter Voltage	V _{BE}	2		3 ^a		-	-	-	-	-	1	V
		4		3 ^a		-	-	1.7	-	-	-	
		4		2 ^a		-	2	-	-	-	-	
		4		5 ^a		-	3	-	-	-	-	
		4		10 ^a		-	-	-	5.7	-	-	
* Collector-to-Emitter Saturation Voltage	V _{CE(sat)}			2 ^a	0.2	-	1	-	-	-	-	V
				3 ^a	0.3	-	-	-	1	-	0.5	
				5 ^a	0.63	-	2	-	-	-	-	
				10 ^a	2	-	-	-	5	-	-	
Power Rating Test	PRT	67		1.5		1	-	-	-	-	-	s
		78		1.5		-	-	1	-	-	-	
		100		1.5		-	-	-	-	1	-	
* Magnitude of Common- Emitter, Small-Signal, Short-Circuit, Forward Current Transfer Ratio:	h _{fe}											
		4		0.5		4	-	-	-	-	-	
f = 50 kHz		4		1		-	-	-	-	2	-	
f = 40 kHz		4		2		-	-	2	-	-	-	
* Common-Emitter, Small- Signal, Short-Circuit, Forward Current Trans- fer Ratio (f = 1 kHz)	h _{fe}	4		0.5		40	-	-	-	-	-	
		4		1		-	-	-	-	10	-	
		4		2		-	-	12	72	-	-	
Thermal Resistance: Junction-to-Case	R _{θJC}					-	1.75	-	1.5	-	1.17	°C/W

* In accordance with JEDEC registration data format JS-6 RDF-2

^a Pulse test; pulse duration = 300 μs, rep. rate = 60 Hz

2N3442, 2N4347, 2N6262

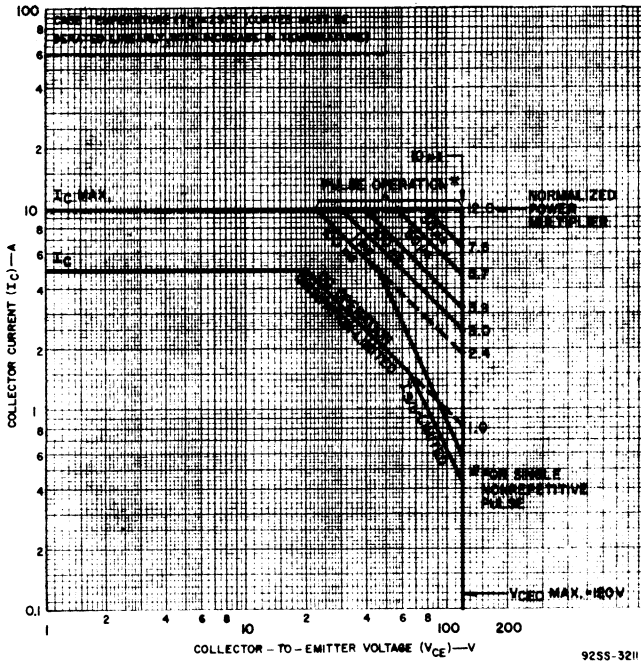


Fig. 4 - Maximum operating areas for 2N4347.

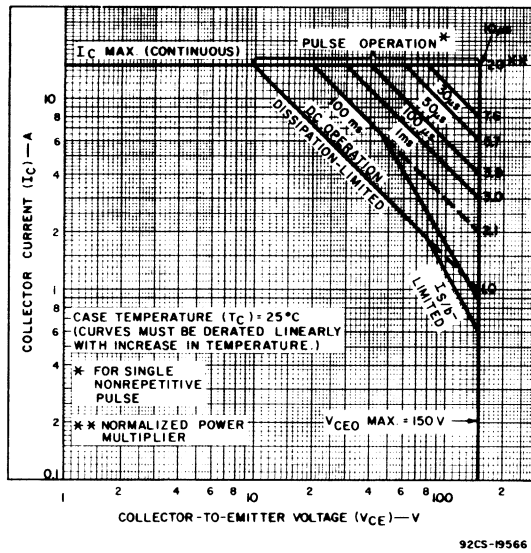


Fig. 5 - Maximum operating areas for 2N6262.

2N3442, 2N4347, 2N6262

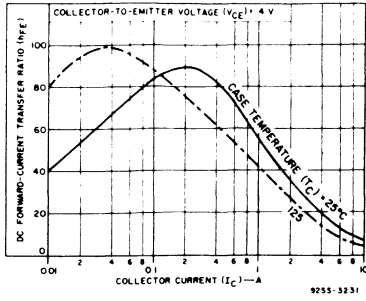


Fig. 6 - Typical dc beta characteristics for 2N3442.

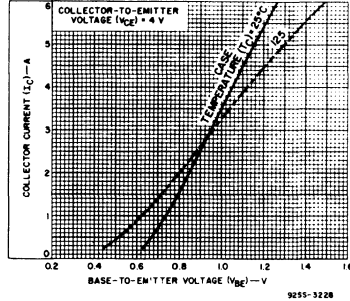


Fig. 7 - Typical transfer characteristics for 2N3442 and 2N4347.

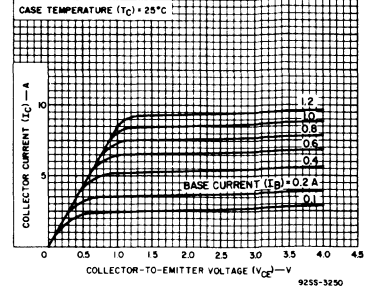


Fig. 8 - Typical small-signal output characteristics for 2N3442.

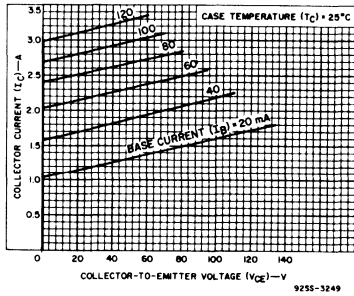


Fig. 9 - Typical large-signal output characteristics for 2N3442.

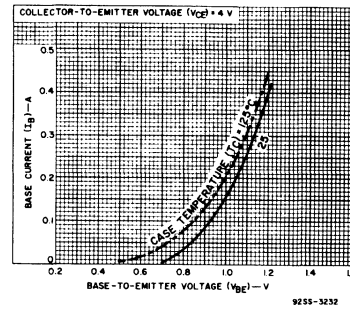


Fig. 10 - Typical input characteristics for 2N3442.

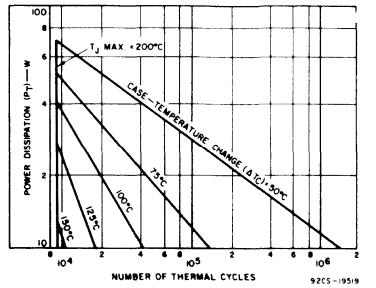


Fig. 11 - Thermal-cycle rating chart for 2N4347.

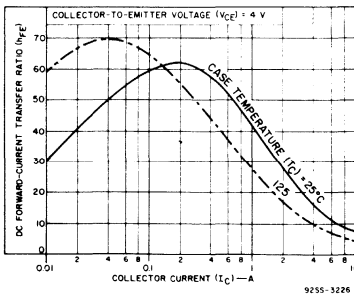


Fig. 12 - Typical dc beta characteristics for 2N4347.

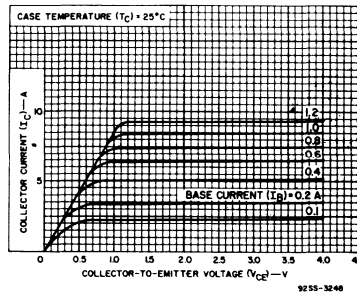


Fig. 13 - Typical small-signal output characteristics for 2N4347.

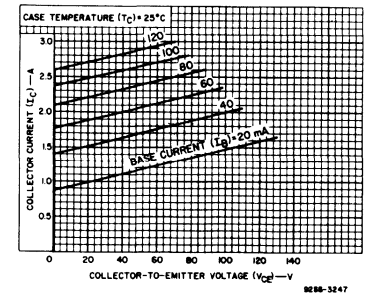


Fig. 14 - Typical large-signal output characteristics for 2N4347.

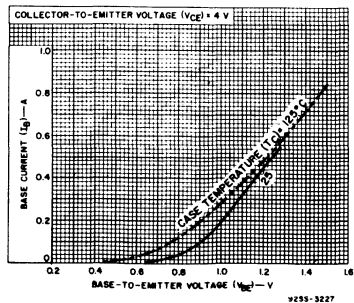


Fig. 15 - Typical input characteristics for 2N4347.

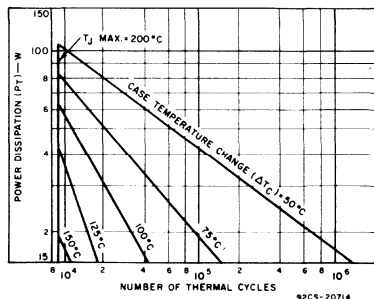


Fig. 16 - Thermal-cycle rating chart for 2N6262.

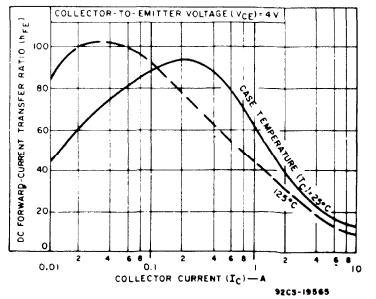


Fig. 17 - Typical dc beta characteristics for 2N6262.

2N3442, 2N4347, 2N6262

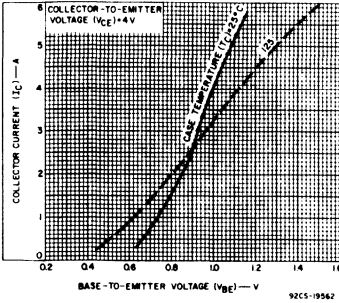


Fig. 18 - Typical transfer characteristics for 2N6262.

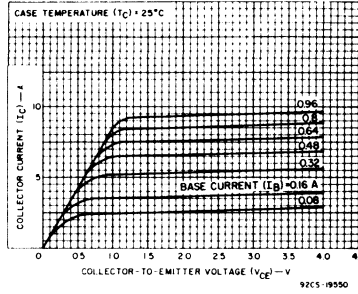


Fig. 19 - Typical small-signal output characteristics for 2N6262.

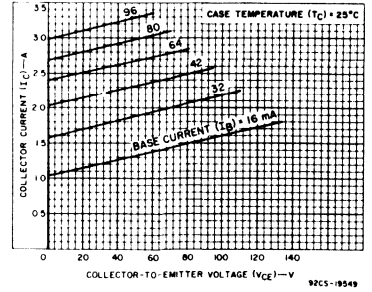


Fig. 20 - Typical large-signal output characteristics for 2N6262.

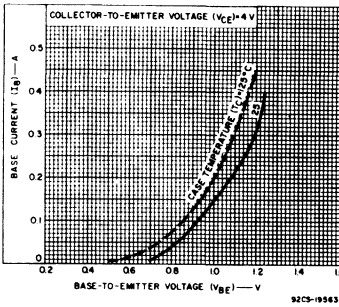


Fig. 21 - Typical input characteristics for 2N6262.

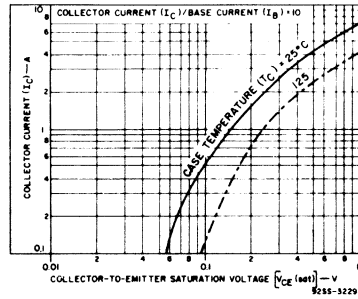


Fig. 22 - Typical saturation-voltage characteristics for all types.

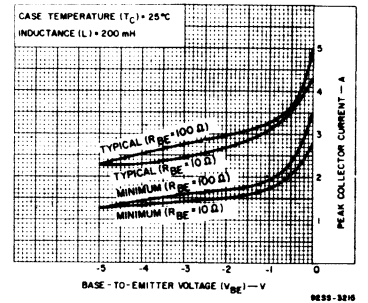


Fig. 23 - Reverse-bias, second-breakdown characteristics for all types.

2N3583-2N3585, 2N4240, 40374

High Voltage Silicon N-P-N Transistor

For High-Speed Switching, Linear-Amplifier Applications, and Off-Line Switching-Regulator Type Power-Supply Applications

These RCA types are silicon n-p-n transistors with high breakdown voltages and fast switching speeds.

Typical applications for these transistors include high-voltage operational amplifiers, high-voltage switches, switching regulators, converters, inverters, deflection- and hi-fi amplifiers.

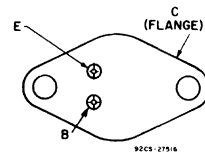
These transistors are also intended for a wide variety of applications in ac/dc commercial equipment.

Types 2N3583, 2N3584, 2N3585, and 2N4240 are supplied in hermetic JEDEC TO-66 packages. Type 40374 is a 2N3583 with a factory-attached heat radiator.

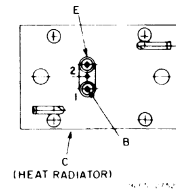
Features for JEDEC Types:

- 100-percent tested to assure freedom from second breakdown in both forward- and reverse-bias conditions when operated within specified limits
- Economy types for ac/dc circuits
- Fast turn-on time at high collector current

TERMINAL DESIGNATIONS



JEDEC TO-66 2N3583, 2N3584, 2N3585, 2N4240, 40850



JEDEC TO-66 with Heat Radiator 40374

MAXIMUM RATINGS, Absolute-Maximum Values:

	2N3583	2N3584	2N3585 2N4240	40374	
*COLLECTOR-TO-BASE VOLTAGE V_{CBO}	250	375	500	250	V
*COLLECTOR-TO-EMITTER SUSTAINING VOLTAGE:					
With base open $V_{CEO(sus)}$	175	250	300	175	V
*EMITTER-TO-BASE VOLTAGE V_{EBO}	6	6	6	6	V
*CONTINUOUS COLLECTOR CURRENT I_C	1	2	2	2	A
*PEAK COLLECTOR CURRENT I_{CM}	5	5	5	5	A
*CONTINUOUS BASE CURRENT I_B	1	1	1	1	A
*TRANSISTOR DISSIPATION P_T					
At case temperature (T_C) = 25°C	35	35	35	—	W
At ambient temperature (T_A) = 25°C	—	—	—	5.8	W
At case temperatures above 25°C	— Derate linearly at 0.2 W/°C —				
For other conditions:	— Derate linearly to 200°C —				
*TEMPERATURE RANGE:					
Storage & Operating (Junction)	—65 to 200—				°C
*PIN TEMPERATURE:					
1/16 in. (1.58 mm) from seating plane for 10 s max.	235	235	235	235	°C

*In accordance with JEDEC registration data format J96 RDF 2 (2N3583), JS-6 RDF 1 (2N3584, 2N3585, 2N4240).

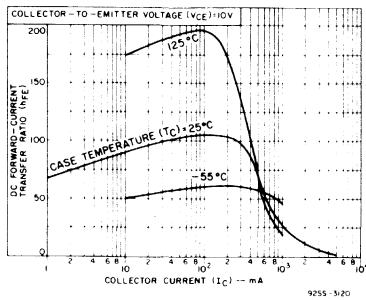


Fig. 1—Typical dc beta vs. collector current for 2N3583, 2N4240 and 40374.

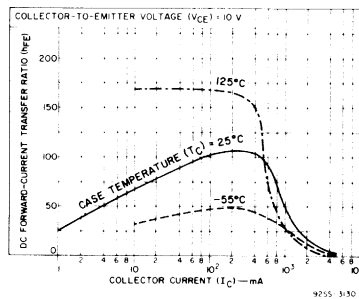


Fig. 2—Typical dc beta vs. collector current for 2N3584 and 2N3585.

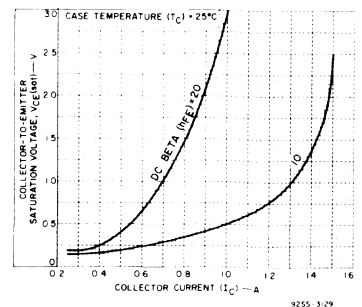


Fig. 3—Typical collector-to-emitter saturation voltage vs. current for 2N3584 and 2N3585.

2N3583-2N3585, 2N4240, 40374

ELECTRICAL CHARACTERISTICS at Case Temperature (T_C) = 25°C Unless Otherwise Specified

CHARACTERISTICS	SYMBOL	TEST CONDITIONS					LIMITS								UNITS													
		VOLT-AGE		CURRENT			2N3583 40374		2N3584		2N3585		2N4240															
		V _{CE}	V _{BE}	I _C	I _E	I _B	MIN.	MAX.	MIN.	MAX.	MIN.	MAX.	MIN.	MAX.														
Collector-Cutoff Current	I _{CEO}	150				0		10		5		5		5	mA													
Collector Cutoff Current	I _{CEV}	225	15					1.0							mA													
		340	-15						1.0					2.0														
		450	-15							1.0																		
At $T_C = 150^\circ\text{C}$		225	-15					3						5.0	mA													
300	-15								3																			
Emitter Cutoff Current	I _{EBO}		-6	0				5.0		0.5		0.5		0.5	mA													
DC Forward Transfer Ratio	h _{FE}	2		750*									10	100														
		2		1A*					8	80	8	80																
		10		100*			40	200	40	40	40	40																
		10		750*			40					30	150															
		10		1A			10		25	100	25	100																
Collector to Emitter Sustaining Voltage: With base open	V _{CEO(sus)}			200	0	175*		250*		300*				300*	V													
With external base to emitter resistance (R _{BE}) = 50 Ω	I _{CER}	250	300	450	200		1.0		1.0		1.0		1	1.0	mA													
Emitter to Base Voltage	V _{EBO}			0	5										V													
Base to Emitter Saturation Voltage	V _{BE(sat)}			750*	75	100		1.4		1.4		1.4		1.8	V													
Collector to Emitter Saturation Voltage	V _{CE(sat)}			750*	75	125		5		0.75		0.75		1.0	V													
Small Signal Forward Current Transfer Ratio	h _{fe}	10	200			3	350		3		3		3															
		30	100			25	350																					
Magnitude of Common Emitter, Small Signal, Short-Circuit, Forward Current Transfer Ratio	h _{te}	10	200			2		2		2		3																
Output Capacitance (V _{CB} = 10 V, f = 1 MHz)	C _{out}			0			120		120		120		120		pF													
Second Breakdown Collector Current With base forward biased**	I _{S1B}	100					350		350		350		350		mA													
Second Breakdown Energy with base reverse biased	E _{S1B}	-4	1A	pk		50		200	200		50				μJ													
																R _{BE} = 20Ω, L = 100 μH	2A	pk										
Saturated Switching Time (V _{CE} = 200 V)	t _r	1A	750			100	75		3		3		0.5		μs													
																Rise Time (See Figs. 13 & 16)	1A	750			100	75		4		4		6
Thermal Resistance: Junction to Case	R _{θJC}						5 (Max.)		5		5		5		°C/W													
Junction to Ambient	R _{θJA}						70 (Max.)		70		70		70		°C/W													

* In accordance with JEDEC registration data formal JS 6 RDF 2 (2N3583), JS 6 RDF 1 (2N3584, 2N3585, 2N4240)
 • CAUTION: The sustaining voltages V_{CEO(sus)} and V_{CER(sus)} MUST NOT be measured on a curve tracer
 ** Specified value of I_{S1B} for given value of V_{CE} as base voltage is increased from zero in a positive direction.
 • Pulsed, pulse duration = 300 μs; duty factor ≤ 2%.

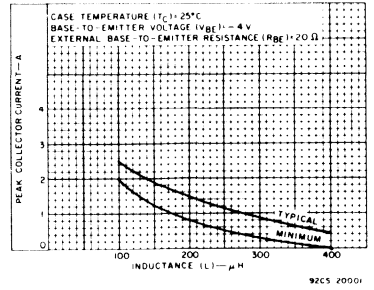


Fig. 4—Reverse-bias second breakdown characteristics for 2N3584 and 2N3585.

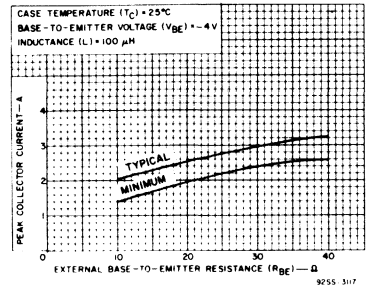


Fig. 5—Reverse-bias second breakdown characteristics for 2N3584 and 2N3585.

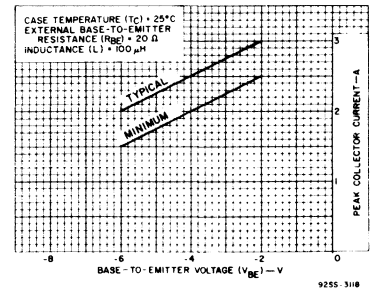


Fig. 6—Reverse-bias second breakdown characteristics for 2N3584 and 2N3585.

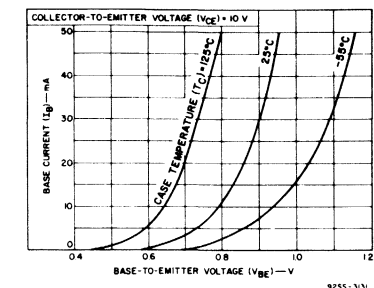


Fig. 7—Typical input characteristics for all types.

2N3583-2N3585, 2N4240, 40374

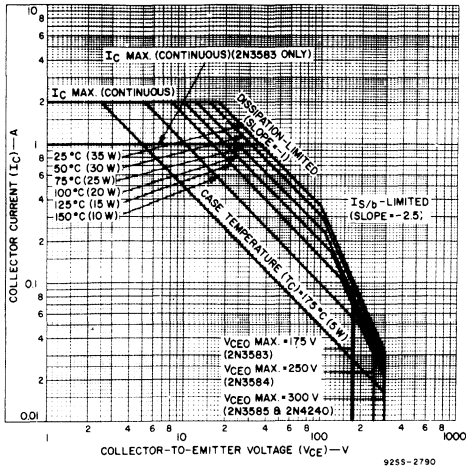


Fig. 8—Maximum operating areas for 2N3583, 2N3584, 2N3585, and 2N4240 (pulse conditions).

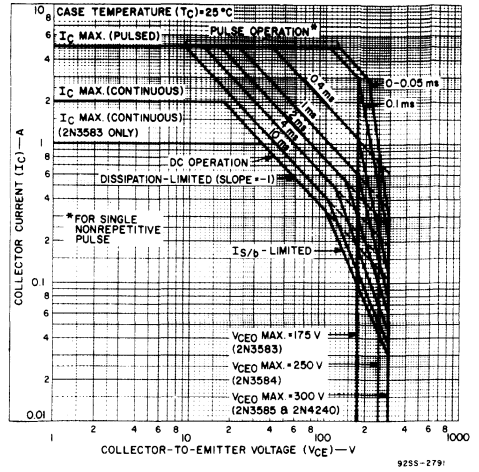


Fig. 9—Maximum operating areas for 2N3583, 2N3584, 2N3585, and 2N4240 (dc conditions).

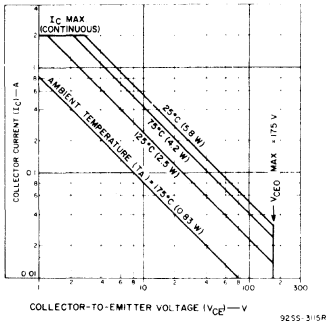


Fig. 10—Maximum operating areas for 40374.

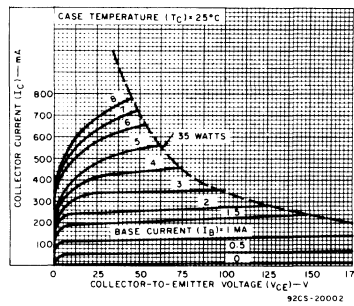


Fig. 11—Typical output characteristics for 2N3583 and 40374.

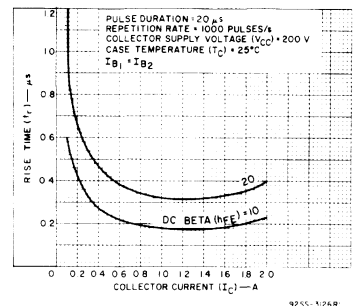


Fig. 12—Typical rise time vs. collector current for 2N3584 and 2N3585.

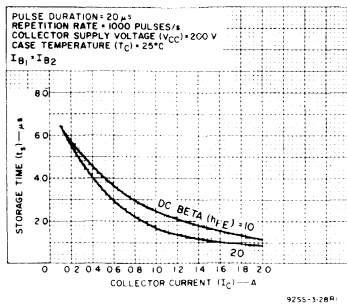


Fig. 13—Typical storage time vs. collector current for 2N3584 and 2N3585.

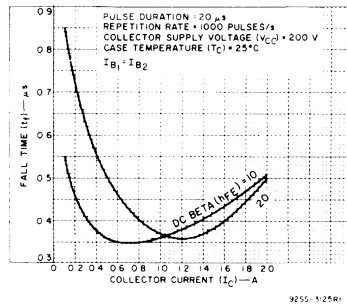


Fig. 14—Typical fall time vs. collector current for 2N3584 and 2N3585.

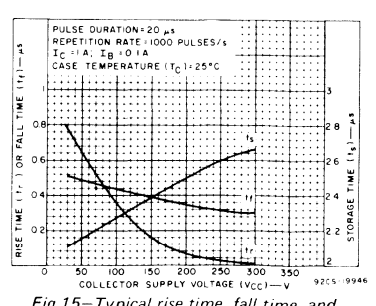


Fig. 15—Typical rise time, fall time, and storage time vs. collector supply voltage for 2N3584 and 2N3585.

2N3715, 2N3716

Silicon N-P-N Epitaxial-Base High-Power Transistors

Rugged, Broadly Applicable Devices
For Industrial and Commercial Use

The RCA-2N3715 and 2N3716 are epitaxial-base silicon n-p-n transistors featuring high gain and high current. They may be used as complements to the RCA-2N3791 and 2N3792 respectively. These devices have a dissipation capability of 150 watts at case temperature up to 25°C.

They differ in voltage ratings and in the currents at which the parameters are controlled. Both are supplied in the steel JEDEC TO-204MA hermetic package.

Features:

- High dissipation capability
- Low saturation voltages
- Maximum safe-area-of-operation curves
- Hermetically sealed JEDEC TO-3/TO-204MA package
- High gain at high current
- Thermal-cycling rating curve

Applications:

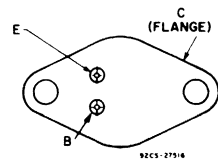
- Series and shunt regulators
- High-fidelity amplifiers
- Power-switching circuits
- Solenoid drivers

MAXIMUM RATINGS, Absolute-Maximum Values:

	2N3715	2N3716	
* V_{CBO}	80	100	V
* $V_{CEO(sus)}$	60	80	V
* V_{EBO}	7	7	V
* I_C	10	10	A
* I_B	4	4	A
* P_T			
At $T_C \leq 25^\circ C$	150	150	W
At $T_C > 25^\circ C$	Derate linearly		$W/^\circ C$
* T_{stg}, T_J	-65 to 200		$^\circ C$
* T_L	235		$^\circ C$
At distance $\geq 1/32$ in. (0.8 mm) from seating plane for 10 s max.			

* In accordance with JEDEC registration data.

TERMINAL DESIGNATIONS



JEDEC TO-204MA

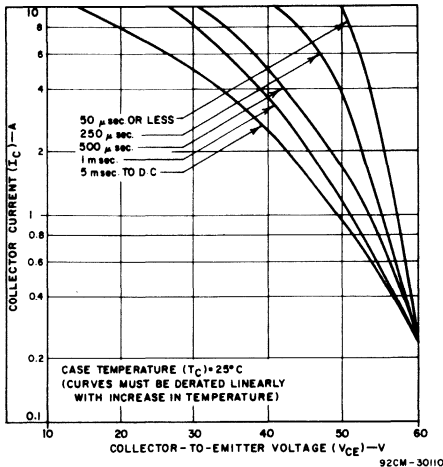


Fig. 1 - Maximum operating areas for 2N3715.

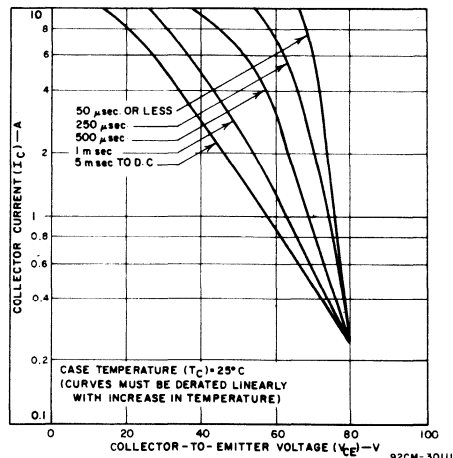


Fig. 2 - Maximum operating areas for 2N3716.

2N3715, 2N3716

ELECTRICAL CHARACTERISTICS,
at Case Temperature (T_C) = 25°C Unless Otherwise Specified

CHARACTERISTIC	TEST CONDITIONS				LIMITS				UNITS
	VOLTAGE V dc		CURRENT A dc		2N3715		2N3716		
	V_{CE}	V_{BE}	I_C	I_B	MIN.	MAX.	MIN.	MAX.	
* I_{CEX}	80 100	-1.5 -1.5			-	1	-	1	mA
* I_{CEX} , $T_C = 150^\circ\text{C}$	60 80	-1.5 -1.5			-	10	-	10	mA
* I_{CEO}	30 40			0 0	-	0.7	-	0.7	mA
* I_{EBO}		-7	0		-	1.0	-	1.0	mA
* $V_{CEO(sus)}^b$			0.2	0	60	-	80	-	V
* h_{FE}	2 2 4		1 ^a 3 ^a 10		50 30 5	150	50 30 5	150	
* V_{BE}^a	2		3		-	1.5	-	1.5	V
* $V_{BE(sat)}^a$			5	0.5	-	1.5	-	1.5	V
* $V_{CE(sat)}^a$			5	0.5	-	0.8	-	0.8	V
* $ h_{fe} $ $f = 1 \text{ MHz}$	10		0.5		5	-	5	-	
* f_{hfe}	10		0.5		30	-	30	-	KHz
* h_{fe} $f = 1 \text{ KHz}$	10		0.5		25	250	25	250	
* C_{ob} $V_{CB} = 10 \text{ V}$ $f = 1 \text{ MHz}$			0		-	250	-	250	pF
I_S/b $t_p = 1s$	40				2.7	-	2.95	-	A
$R_{\theta JC}$					-	1.17	-	1.17	°C/W

* In accordance with JEDEC registration data.
^a Pulsed; pulse duration = 200 μs , duty factor = 1.5%.

b CAUTION: Sustaining voltages $V_{CEO(sus)}$ and $V_{CER(sus)}$ **MUST NOT** be measured on a curve tracer.

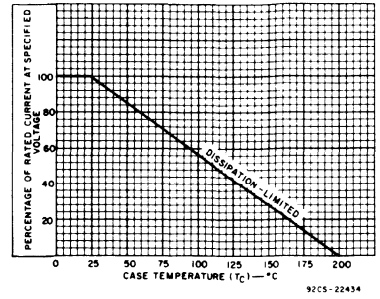


Fig. 3 - Derating curve.

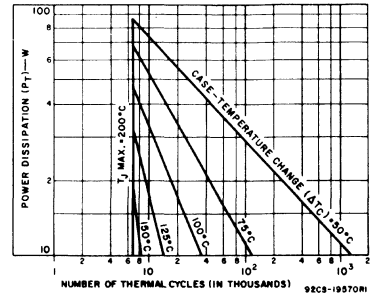


Fig. 4 - Thermal-cycling rating chart.

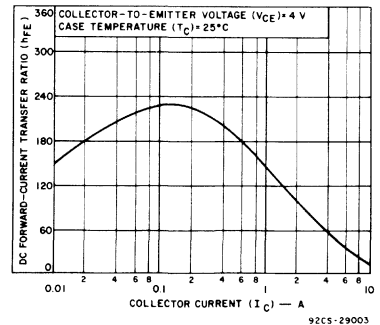


Fig. 5 - Typical dc beta characteristics for both types.

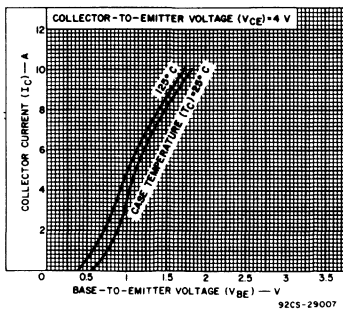


Fig. 6 - Typical transfer characteristics for both types.

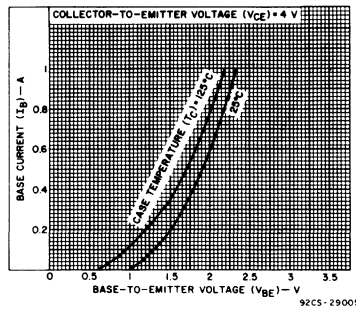


Fig. 7 - Typical input characteristics for both types.

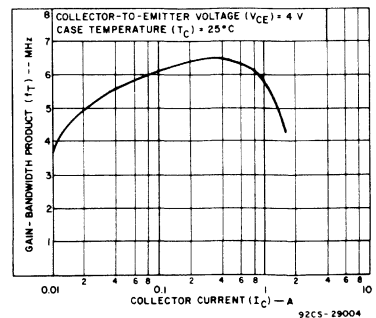


Fig. 8 - Typical gain-bandwidth product for both types.

2N3771, 2N3772, 2N6257, RCS258

Hometaxial-Base, High-Power N-P-N Transistors

Rugged Silicon N-P-N Devices for Applications in Industrial and Commercial Equipment

These RCA types are hometaxial base, silicon n-p-n transistors intended for a wide variety of high-power, high-current applications. Typical applications for these transistors include power-switching circuits, audio amplifiers, series- and shunt-

regulator driver and output stages, dc-to-dc converters, inverters, and solenoid (hammer)/relay driver service.

All devices employ the popular JEDEC TO-3 package; they differ in maximum ratings for voltage, current, and power.

Features:

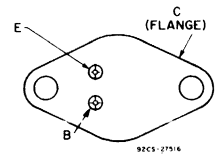
- High dissipation capability
- $V_{CEX}(sus)$ at 3 A = 50 V min. (2N3771, 2N6257) = 90 V min. (2N3772)
- 15-A specification for: $h_{FE}, V_{BE},$ & $V_{CE}(sat)$ (2N3771, 2N6257)
- 10-A specification for: $h_{FE}, V_{BE},$ & $V_{CE}(sat)$ (2N3772, RCS258)
- Low saturation voltage with high beta

MAXIMUM RATINGS, Absolute Maximum Values:

	2N3771	2N3772	2N6257	RCS258	
*COLLECTOR TO BASE VOLTAGE	50	100	50	100	V
*COLLECTOR TO EMITTER VOLTAGE					
With -1.5 V (V_{BE}) & $R_{BE} = 100\Omega$	V_{CEX}	50	80	50	80
With base open	V_{CEO}	40	60	40	60
*EMITTER TO BASE VOLTAGE	V_{EBO}	5	7	5	7
*CONTINUOUS COLLECTOR CURRENT	I_C	30	20	20	20
*PEAK COLLECTOR CURRENT	I_{CM}	30	30	30	30
*CONTINUOUS BASE CURRENT	I_B	7.5	5	5	5
*PEAK BASE CURRENT	I_{BM}	15	15	15	15
*TRANSISTOR DISSIPATION:	P_T				
At case temperatures up to 25°C		150	150	150	250
At case temperatures above 25°C		Derate linearly to 200°C			
*TEMPERATURE RANGE					
Storage & Operating (Junction)			65 to 200		°C
*PIN TEMPERATURE (During soldering)					
At distance ≥ 1.32 in. (0.8 mm) from seating plane for 10 s max.			230		

*In accordance with JEDEC registration data format JS 6 RDF 2

TERMINAL DESIGNATIONS



JEDEC TO-3

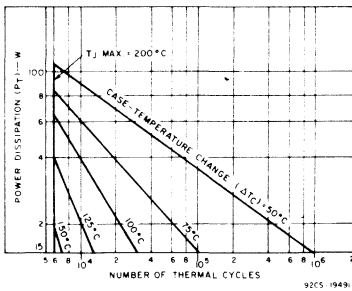


Fig. 1—Thermal-cycle rating chart for 2N3771, 2N3772, and 2N6257.

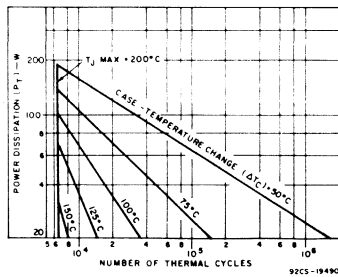


Fig. 2—Thermal-cycle rating chart for RCS258.

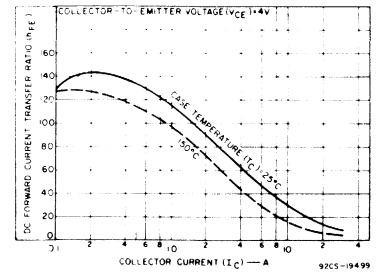


Fig. 3—Typical dc beta characteristics for 2N3771.

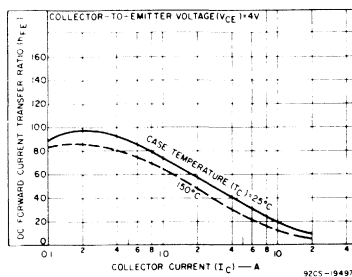


Fig. 4—Typical dc beta characteristics for 2N3772, 2N6257 and RCS258.

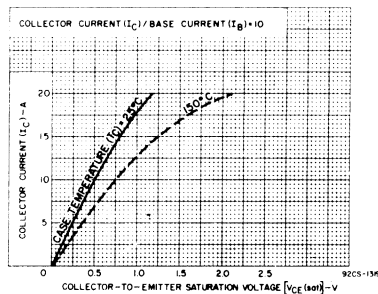


Fig. 5—Typical saturation-voltage characteristics for 2N3771.

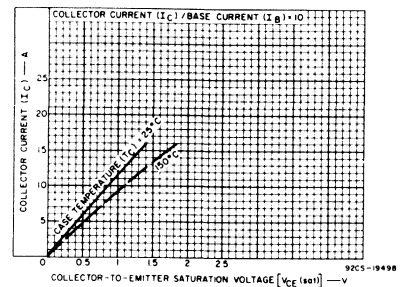


Fig. 6—Typical saturation-voltage characteristics for 2N3772, 2N6257 and RCS258.

2N3771, 2N3772, 2N6257, RCS258

ELECTRICAL CHARACTERISTICS, At Case Temperature (T_C) = 25° Unless Otherwise Specified

CHARACTERISTIC	SYMBOL	TEST CONDITIONS					LIMITS								UNITS
		VOLTAGE V dc			CURRENT A dc		2N3771		2N3772		2N6257		RCS258		
		V _{CB}	V _{CE}	V _{BE}	I _C	I _B	MIN.	MAX.	MIN.	MAX.	MIN.	MAX.	MIN.	MAX.	
Collector-Cutoff Current With emitter open	I _{CBO}	50 100					– 2*	– –	– 5*	– –	4 –	– –	– 5	mA	
With base-emitter junction reverse-biased	I _{CEX}		45 50 100	–1.5 –1.5 –1.5			– 2 –	– – 5	– – –	– – –	4 – –	– – –	– – 5	mA	
With base-emitter junction reversed-biased, T _C = 150°C	I _{CEX}		30 45 30	–1.5 –1.5 –1.5			– 10 –	– – –	10 – –	– – –	– 20 –	– – –	– – 10	mA	
With base open	I _{CEO}		25 30 50			0 0 0	– 10 –	– – –	– – 10	– – –	10 – –	– – –	– 10 –	mA	
Emitter-Cutoff Current	I _{EBO}			–5 –7	0 0		– 5 –	– – –	– – 5	– – –	10 – –	– – –	– 5 –	mA	
DC Forward Current Transfer Ratio	h _{FE}		4 4 4 4		30 ^a 20 ^a 15 ^a 10 ^a 8 ^a		5 – 15 – –	– – 60 – –	– 5 – 15 –	– – – 60 –	– – – – 15	– – – 15 75	– – – 60 –		
Collector to Emitter Sustaining Voltage With base-emitter Junction reversed-biased (R _{BE} = 100Ω)	V _{CEX(sus)}			–1.5	0.2 ^a		50	–	80	–	50	–	80	V	
With external base-to-emitter resistance (R _{BE}) = 100Ω	V _{CEr(sus)}				0.2 ^a		45	–	70	–	45	–	70	V	
With base open	V _{CEO(sus)}				0.2 ^a	0	40	–	60	–	40	–	60	V	
Base to Emitter Voltage	V _{BE}		4 4 4		15 ^a 10 ^a 8 ^a		– – –	2.7 – –	– – –	– 2.2 –	– – –	– – 2.2	– – –	2.2 – –	V
Collector to Emitter Saturation Voltage	V _{CE(sat)}				30 ^a 20 ^a 15 ^a 10 ^a 8 ^a	6 4 1.5 1 0.8	– – – – –	4 – 2 – –	– – – 1.4 –	– – – – –	– 4 – – –	– 4 – – –	– 4 – 1.4 –	V	
Second-Breakdown Collector Current With base forward-biased and 1- μ s nonrepetitive pulse	I _{S/b} ^b		60 40				– 3.75	– –	2.5 –	– –	– 3.75	– –	4.2 –	– –	A
Second-Breakdown Energy With base reverse biased and L = 40mH, R _{BE} = 100Ω	E _{S/b} ^c			–1.5	5		500	–	500	–	500	–	500	mJ	
Magnitude of Common-Emitter, Small-Signal, Short-Circuit, Forward Current Transfer Ratio (f = 0.05 MHz)	h _{fe}		4		1		4*	16 (Typ)	4*	16 (Typ)	4*	16 (Typ)	4	16 (Typ)	
Common-Emitter, Small-Signal, Short-Circuit, Forward Current Transfer Ratio (f = 1 kHz)	h _{fe}		4		1		40	–	40	–	40	–	40	–	
Thermal Resistance: Junction-to-Case	R _{θJC}						–	1.17	–	1.17	–	1.17	–	0.7	°C/W

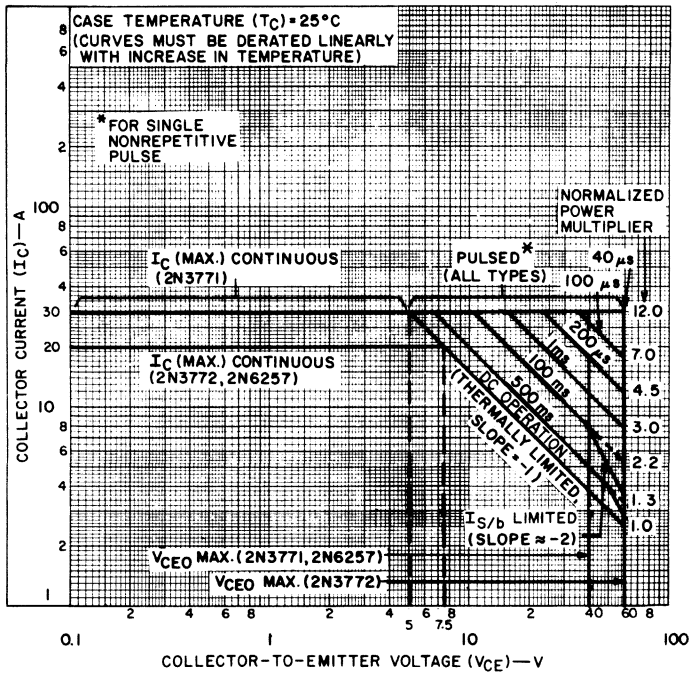
* In accordance with JEDEC registration data formal JS-6 RDF-2.

^a Pulsed; pulse duration = 300 μ s, rep. rate = 60 Hz, duty factor \leq 2%.

^b I_{S/b} is defined at the current at which second breakdown occurs at a specified collector voltage with the emitter-base junction forward biased for transistor operation in the active region.

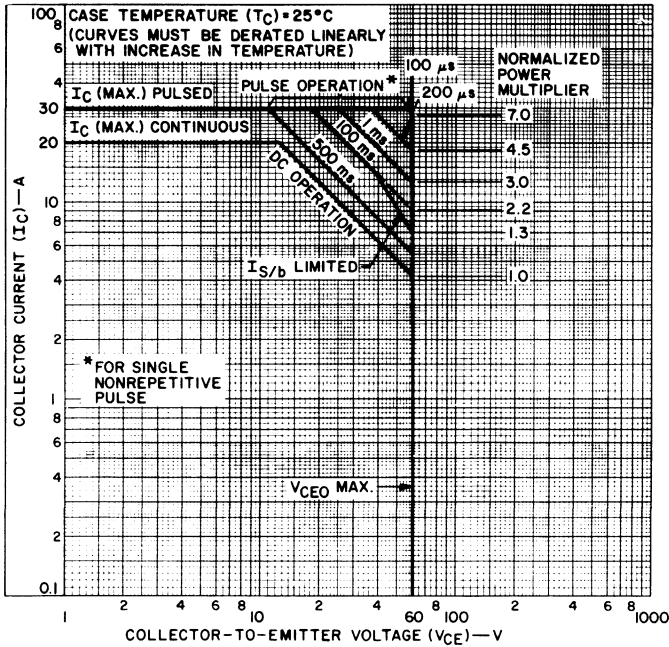
^c E_{S/b} is defined as the energy at which second breakdown occurs under specified reverse-bias conditions. E_{S/b} = ½ LI², where L is a series load or leakage inductance and I is the peak collector current.

2N3771, 2N3772, 2N6257, RCS258



92CS-28551

Fig. 7— Maximum operating areas for 2N3771, 2N3772, and 2N6257.



92CS-26449

Fig. 8— Maximum operating areas for RCS258.

2N3771, 2N3772, 2N6257, RCS258

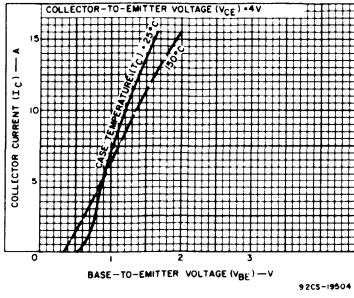


Fig. 9—Typical transfer characteristics for 2N3771.

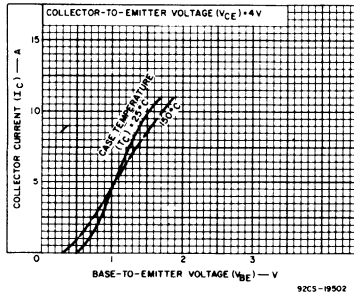


Fig. 10—Typical transfer characteristics for 2N3772, 2N6257 and RCS258.

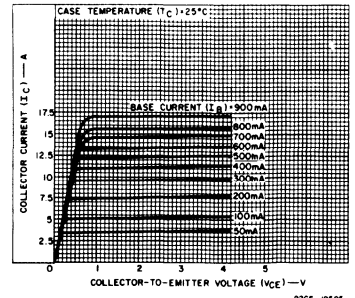


Fig. 11—Typical output characteristics for 2N3771.

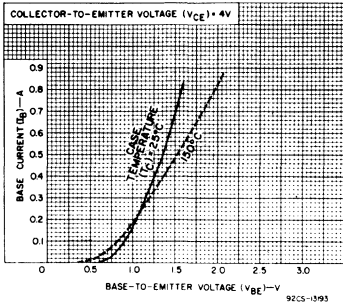


Fig. 12—Typical input characteristics for 2N3771 and 2N6257.

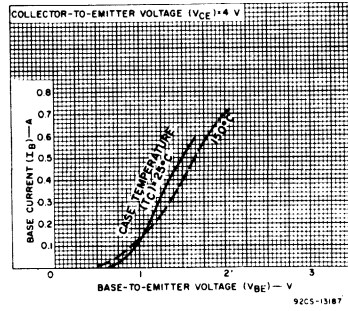


Fig. 13—Typical input characteristics for 2N3772 and RCS258.

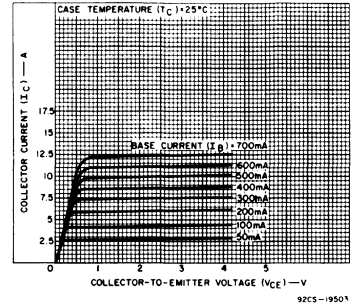


Fig. 14—Typical output characteristics for 2N3772, 2N6257 and RCS258.

2N3773, 2N4348, 2N6259

Hometaxial-Base, High Current Silicon N-P-N Transistors

Rugged High-Voltage Devices for Applications in Industrial and Commercial Equipment

These RCA types are hometaxial-base silicon n-p-n transistors intended for a wide variety of high-voltage high-current applications. Typical applications for these transistors include power-switching circuits, audio amplifiers, series- and shunt-regulator driver and output stages, dc-to-dc

converters, inverters, and solenoid (hammer)/relay driver service.

These devices employ the popular JEDEC TO-3 package; they differ in maximum ratings for voltage, current, and power.

Features:

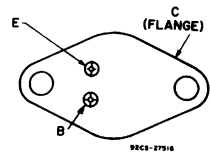
- High dissipation capability – 120 W (2N4348), 150 W (2N3773), 250 W (2N6259)
- 5-A specification for h_{FE} , V_{BE} , & $V_{CE(sat)}$ (2N4348)
- 8-A specification for h_{FE} , V_{BE} , & $V_{CE(sat)}$ (2N3773, 2N6259)
- V_{CEX} – 140 V min (2N4348), 160 V min (2N3773), 170 V min (2N6259)
- Low saturation voltage with high beta

MAXIMUM RATINGS, Absolute-Maximum Values:

	2N4348	2N3773	2N6259		
*COLLECTOR-TO-BASE VOLTAGE	140	160	170	V	
COLLECTOR-TO-EMITTER VOLTAGE					
With base open	V_{CEO}	120	140	150	V
With reverse bias (V_{GB}) of -1.5 V	V_{CEX}	140	160	170	V
*EMITTER-TO-BASE VOLTAGE	V_{EBO}	7	7	7	V
*COLLECTOR CURRENT:					
Continuous	I_C	10	16	16	A
Peak		30	30	30	A
*BASE CURRENT:					
Continuous	I_B	4	4	4	A
Peak		15	15	15	A
*TRANSISTOR DISSIPATION:					
At case temperatures up to 25°C	P_T	120	150	250	W
At case temperatures above 25°C		Derate linearly to 200°C			
*TEMPERATURE RANGE:					
Storage & Operating (Junction)		← -65 to +200 →			°C
*PIN TEMPERATURE (During Soldering):					
At distances $\geq 1/32$ in. (0.8 mm) from case for 10 s max.		← 230 →			°C

* In accordance with JEDEC registration data format (J5.6, RDF-2).

TERMINAL DESIGNATIONS



JEDEC TO-3

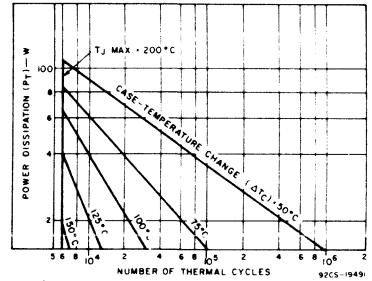


Fig. 2 - Thermal-cycle rating chart for 2N3773.

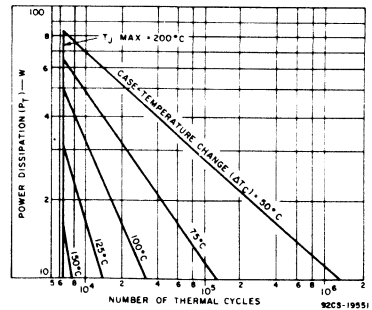


Fig. 3 - Thermal-cycle rating chart for 2N4348.

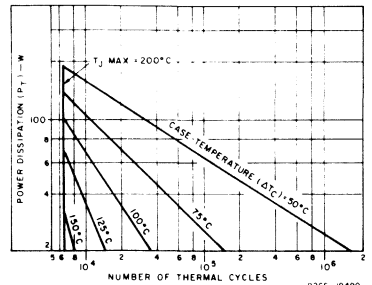


Fig. 4 - Thermal-cycle rating chart for 2N6259.

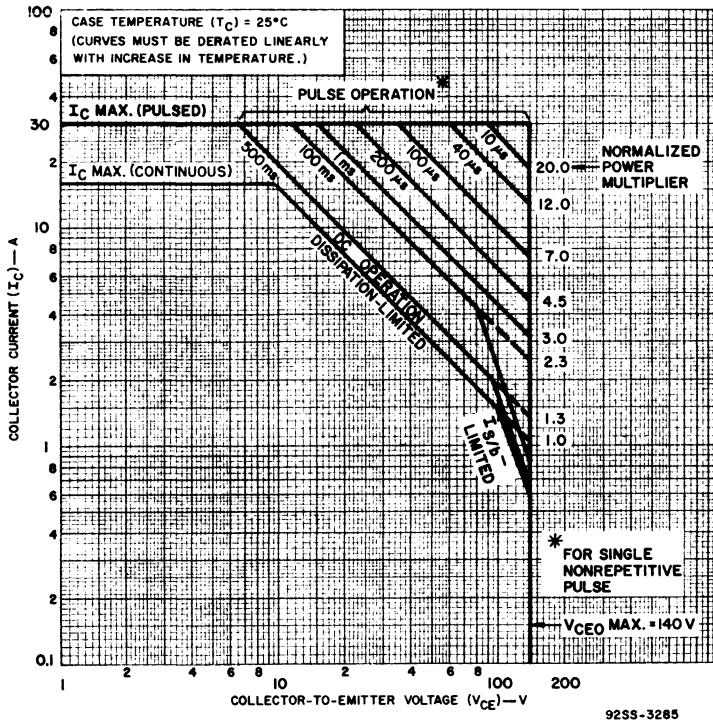


Fig. 1 - Maximum operating areas for 2N3773.

2N3773, 2N4348, 2N6259

ELECTRICAL CHARACTERISTICS, At Case Temperature (T_C) = 25°C Unless Otherwise Specified

CHARACTERISTIC	SYMBOL	TEST CONDITIONS				LIMITS						UNITS
		VOLTAGE		CURRENT		2N4348		2N3773		2N6259		
		V _{CE}	V _{BE}	I _C	I _B	Min.	Max.	Min.	Max.	Min.	Max.	
Collector-Cutoff Current With emitter open, V _{CB} = 140 V	I _{CB0}								2			mA
With base-emitter junction reverse-biased	I _{CEX}	120	-1.5			2						mA
		140	-1.5					2				mA
		150	-1.5							0.2		mA
With base-emitter junction reverse-biased and T _C = 150°C	I _{CEX}	120	-1.5			10						mA
		140	-1.5					10				mA
		150	-1.5							4		mA
With base open	I _{CEO}	100				20		10		2	mA	
		120									mA	
Emitter-Cutoff Current	I _{EBO}		-7	0		5		5		2	mA	
DC Forward Current Transfer Ratio	h _{FE}	4		5 ^a		15	60	15	60	15	60	
		4		8 ^a								
		2		8 ^a		10				15	60	
		4		10 ^a				5		10		
		4		16 ^a								
Collector to Emitter Sustaining Voltage	V _{CE(sus)}		1.5	0.1		140		160		170		V
With base-emitter junction reverse-biased (R _{BE} = 100Ω)												V
With external base-to-emitter resistance (R _{BE} = 100Ω)	V _{CE(sus)}				0.2 ^a	140		150		160		V
With base open	V _{CE0(sus)}				0.2 ^a	0	120	140		150		V
Base to Emitter Voltage	V _{BE}	4		5 ^a			2				2	V
		4		8 ^a					2.2			V
		2		8 ^a								V
		4		10 ^a				3				V
Collector to Emitter Saturation Voltage	V _{CE(sat)}			5 ^a	0.5	1		1.4		1		V
				8 ^a	0.8							V
				10 ^a	1.25	2		4				V
				16 ^a	3.2						2.5	
Second-Breakdown Collector Current	I _{S(b)}					1.5		1.5		2.5	A	
With base forward-biased and 1-s nonrepetitive pulse		80									A	
Second-Breakdown Energy	E _{S(b)}					0.125		0.125		0.125	J	
With base reverse-biased and L = 40 mH, R _{BE} = 100Ω			-1.5	2.5							J	
Magnitude of Common Emitter, Small-Signal, Short-Circuit, Forward Current Transfer Ratio (f = 50 kHz)	h _{fe}	4		1		4		4		4		
Common-Emitter, Small-Signal, Short-Circuit, Forward Current Transfer Ratio (f = 1 kHz)	h _{fe}	4		1		40		40		40		
Thermal Resistance Junction-to-Case	R _{θJC}					1.46		1.17		0.7		°C/W

^a In accordance with JEDEC registration data format JS 6 R D F 2

^b Pulsed, pulse duration = 300µs, rep. rate = 60 Hz

^c I_{S(b)} is defined as the current at which second breakdown occurs at a specified collector voltage with the emitter base junction forward-biased for transistor operation in the active region.

^d E_{S(b)} is defined as the energy at which second breakdown occurs under specified reverse bias conditions: E_{S(b)} = 1.2L I_{S(b)}² where L is a series load or leakage inductance and I is the peak collector current

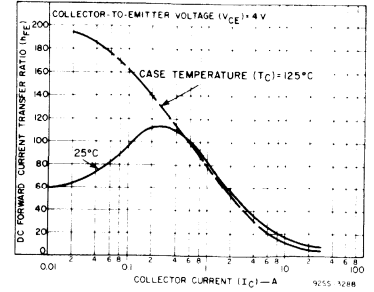


Fig. 5 - Typical dc beta characteristics for 2N3773.

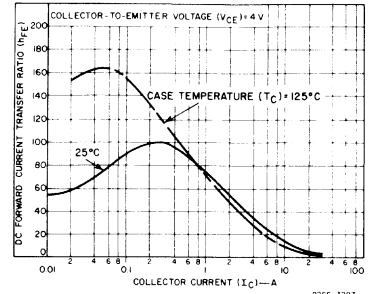


Fig. 6 - Typical dc beta characteristics for 2N4348.

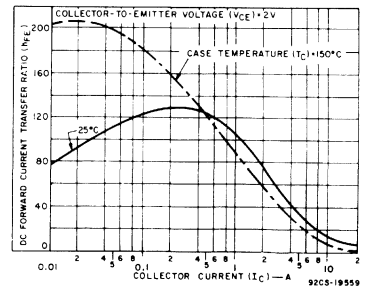


Fig. 7 - Typical dc beta characteristics for 2N6259.

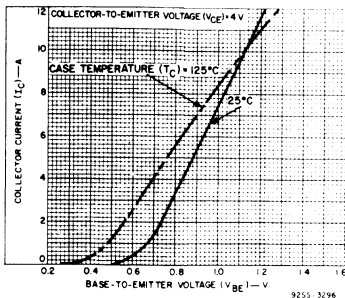


Fig. 8 - Typical transfer characteristics for 2N3773.

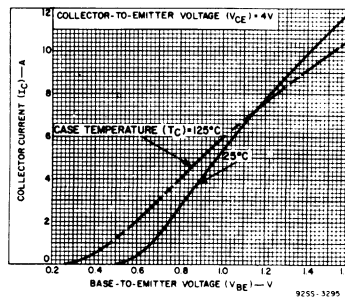


Fig. 9 - Typical transfer characteristics for 2N4348.

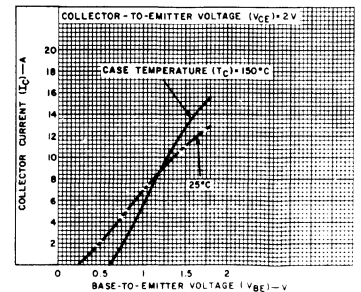


Fig. 10 - Typical transfer characteristics for 2N6259.

2N3773, 2N4348, 2N6259

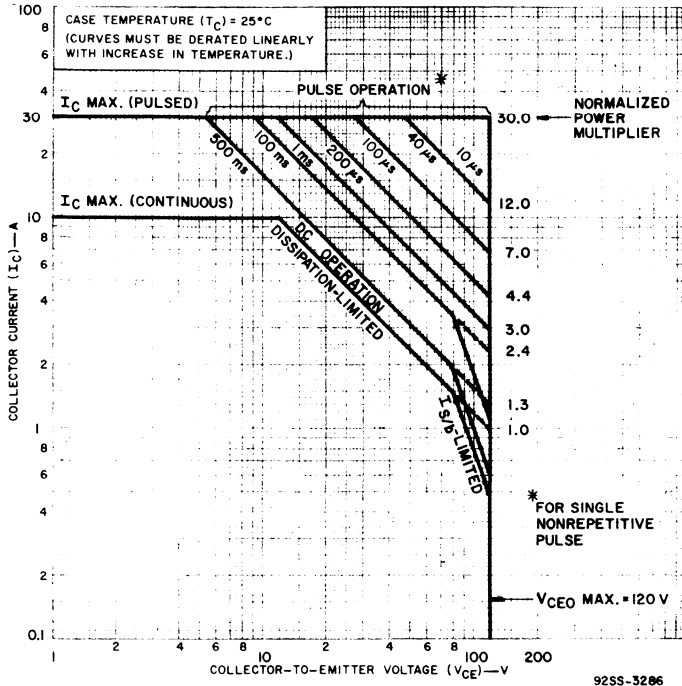


Fig. 11 - Maximum operating areas for 2N4348.

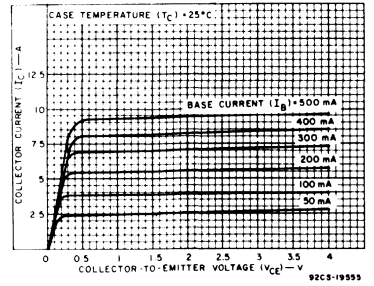


Fig. 12 - Typical output characteristics for 2N3773.

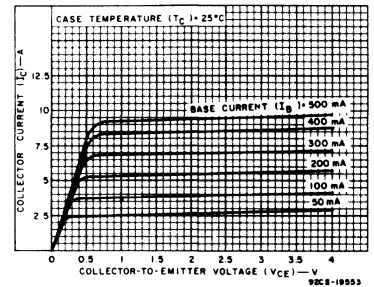


Fig. 13 - Typical output characteristics for 2N4348.

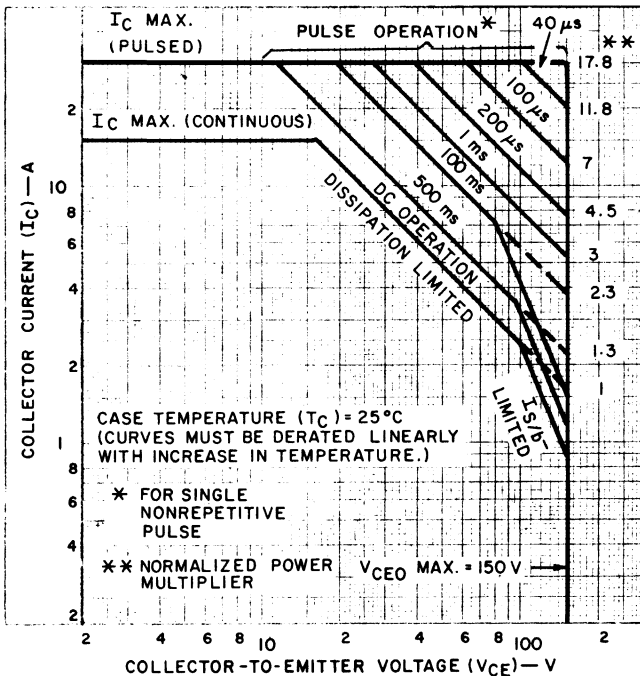


Fig. 14 - Maximum operating areas for 2N6259.

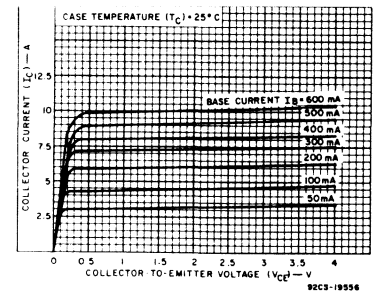


Fig. 15 - Typical output characteristics for 2N6259.

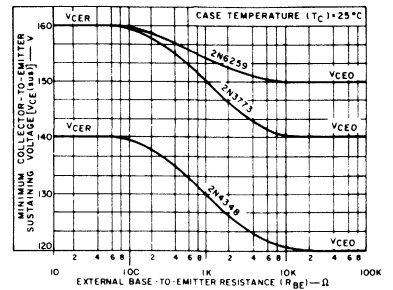


Fig. 16 - Sustaining voltage as a function of base-to-emitter resistance for all types.

2N3773, 2N4348, 2N6259

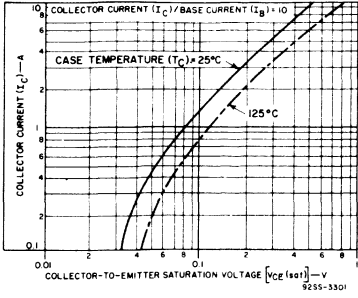


Fig. 17 - Typical saturation-voltage characteristics for 2N3773.

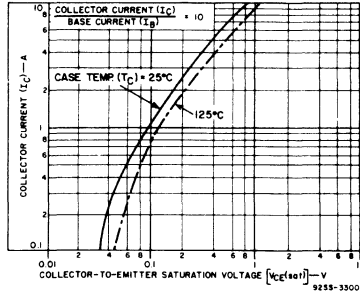


Fig. 18 - Typical saturation-voltage characteristics for 2N4348.

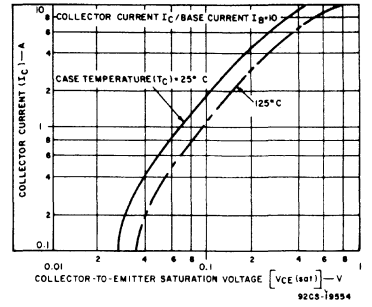


Fig. 19 - Typical saturation-voltage characteristics for 2N6259.

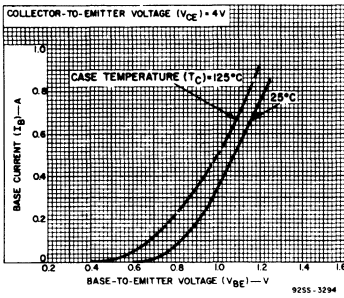


Fig. 20 - Typical input characteristics for 2N3773.

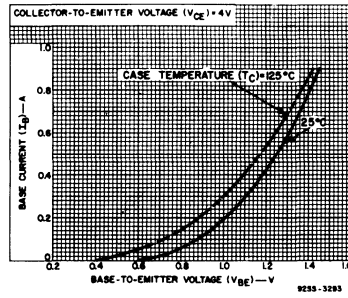


Fig. 21 - Typical input characteristics for 2N4348.

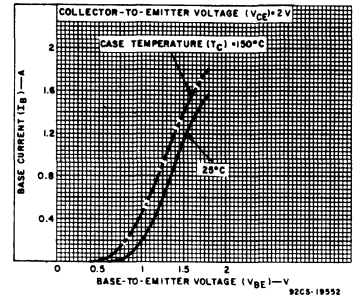


Fig. 22 - Typical input characteristics for 2N6259.

2N3791, 2N3792

Silicon P-N-P Epitaxial-Base High-Power Transistors

Rugged, Broadly Applicable Devices
For Industrial and Commercial Use

The RCA-2N3791 and 2N3792 are epitaxial-base silicon p-n-p transistors featuring high-gain at high current. They may be used as complements to the n-p-n types 2N3715 and 2N3716, respectively. These devices are intended for medium-speed switching and amplifier applications and feature a dissipation capability of 150 watts at case temperatures up to 25°C

They differ in voltage ratings and in the currents at which the parameters are controlled. Both are supplied in the steel JEDEC TO-204MA hermetic package.

Features:

- High dissipation capability
- Low saturation voltages
- Maximum safe-areas-of-operation curves
- Hermetically sealed JEDEC TO-204MA package
- High gain at high current
- Thermal-cycling rating curve

APPLICATIONS:

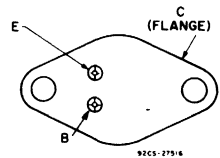
- Series and shunt regulators
- High-fidelity amplifiers
- Power-switching circuits
- Solenoid drivers

Maximum Ratings, Absolute-Maximum Values:

	2N3791	2N3792	
* V_{CBO}	-60	-80	V
* V_{CEO}	-60	-80	V
* V_{EBO}	-7	-7	V
* I_C	-10	-10	A
* I_{CM}	-10	-10	A
* I_B	-4	-4	A
* P_T	150	150	W
$T_C \leq 25^\circ C$	150	150	$W/^\circ C$
$T_C > 25^\circ C$	derate linearly 0.86		$^\circ C$
* T_J, T_{stg}	-65 to 200		$^\circ C$

* In accordance with JEDEC registration data.

TERMINAL DESIGNATIONS



JEDEC TO-204MA

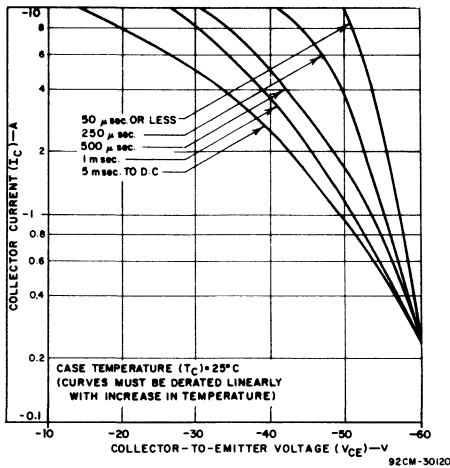


Fig. 1 - Maximum operating areas for 2N3791.

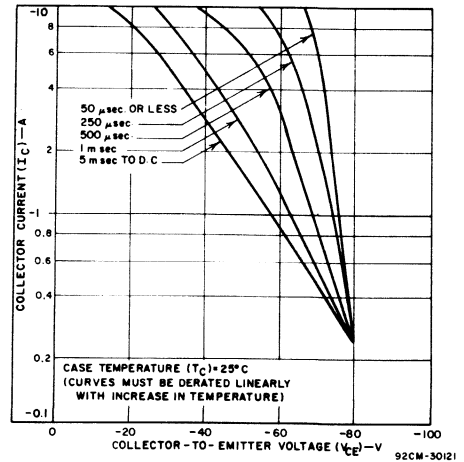


Fig. 2 - Maximum operating areas for 2N3792.

2N3791, 2N3792

ELECTRICAL CHARACTERISTICS, at Case Temperature
(T_C) = 25°C Unless Otherwise Specified

CHARACTERISTICS	TEST CONDITIONS				LIMITS				UNITS
	VOLTAGE V dc		CURRENT A dc		2N3791		2N3792		
	V_{CE}	V_{BE}	I_C	I_B	Min.	Max.	Min.	Max.	
* I_{CEX}	-60	1.5	-	-	-	-1	-	-	mA
	-80	1.5	-	-	-	-	-1		
$T_C = 150^\circ\text{C}$	-60	1.5	-	-	-	-5	-	-	mA
	-80	1.5	-	-	-	-	-5		
* I_{CEO}	-30	-	-	-	-	-10	-	-10	mA
	-40	-	-	-	-	-10	-	-10	
* I_{EBO}		7	-	-	-	-5	-	-5	mA
* $V_{CEO(sus)^b}$			-0.2	0	-60	-	-80	-	
* h_{FE}^a	-2	-1	-	-	50	150	50	150	
	-2	-3	-	-	30	-	30	-	
	-4	-10	-	-	4	-	4	-	
* V_{BE}	-2	-5	-	-	-1.8	-	-1.8	-	V
	-4	-10	-	-	-4.0	-	-4.0	-	
* $V_{BE(sat)}^a$		-5	-0.5	-	-1.5	-	-1.5	-	V
* $V_{CE(sat)}^a$		-5	-0.5	-	-1	-	-1	-	
		-10	-2.0	-	-4	-	-4	-	
* f_{hfe}	-10	-0.5	-	-	30	-	30	-	KHz
* h_{fe} f = 1 KHz	-10	-0.5	-	-	25	250	25	250	
* $ h_{fe} $ f = 1 MHz	-10	-0.5	-	-	4	-	4	-	
* I_S/b tp = 1s	40	-	-	-	2.7	-	2.95	-	
* C_{ob} $V_{CB} = 10\text{ V}$ f = 1 MHz			0	-	-	500	-	500	pF
* $R_{\theta JC}$					-	1.17	-	1.17	

* In accordance with JEDEC registration data.
 a Pulsed; pulse duration = 200 μs , duty factor = 1.5%.
 b CAUTION: Sustaining voltage, $V_{CEO(sus)}$, MUST NOT be measured on a curve tracer.

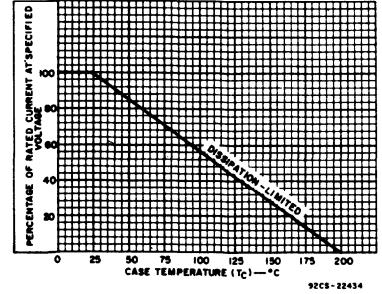


Fig. 3 - Derating curve.

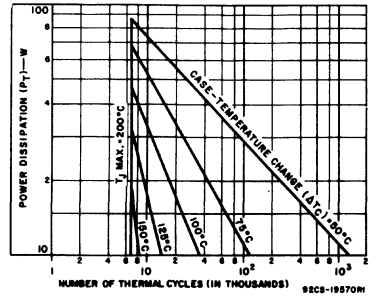


Fig. 4 - Thermal-cycling rating chart.

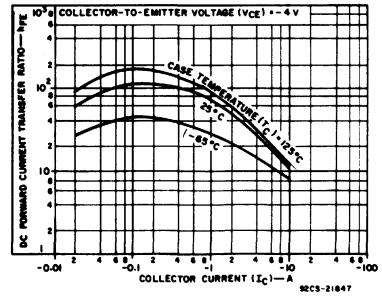


Fig. 5 - Typical dc beta characteristics for both types.

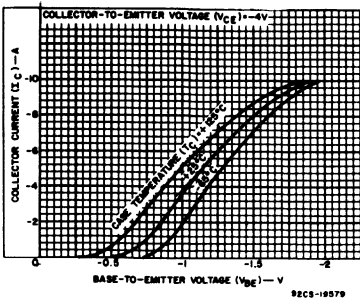


Fig. 6 - Typical transfer characteristics for both types.

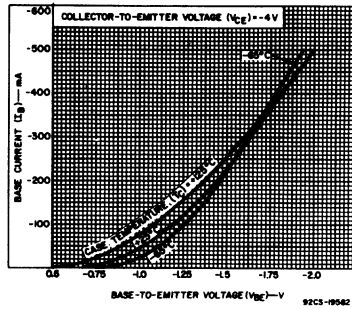


Fig. 7 - Typical input characteristics for both types.

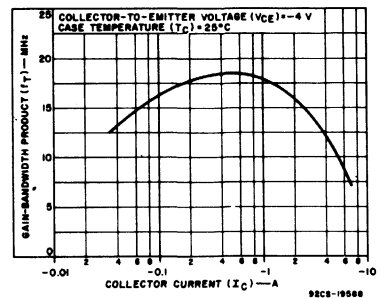


Fig. 8 - Typical gain-bandwidth product for both types.

2N3878, 2N3879, 2N5202, 2N6500, 40375

High-Speed, Epitaxial-Collector Silicon N-P-N Transistors

For High-Speed Switching and Linear-Amplifier Applications

RCA 2N3878, 2N3879, 2N5202, and 2N6500* are epitaxial silicon n-p-n transistors. The 2N3878 is an amplifier type intended for audio-, ultrasonic-, and radio-frequency circuits. Types 2N3879, 2N5202, and 2N6500 are switching transistors intended for use in high-current, high-speed switching circuits. Type 40375 is a 2N3878 with a factory-attached heat radiator; it is intended for printed circuit-board applications.

Typical applications for these transistors include: low-distortion power amplifiers, oscillators, switching regulators, series regulators, converters, and inverters.

* Formerly RCA Dev. Type Nos. TA2509, TA2509A, TA7285, and TA8932, respectively.

MAXIMUM RATINGS, Absolute-Maximum Values:

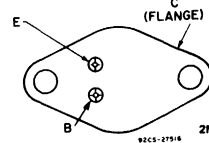
	2N3878 40375	2N3879	2N5202	2N6500		
*COLLECTOR TO BASE VOLTAGE	V _{CB0}	120	120	100	120	V
COLLECTOR-TO-EMITTER SUSTAINING VOLTAGE	V _{CE0} (sus)	65	90	75*	110*	V
With external base-to-emitter resistance (R _{BE}) = 50 Ω	V _{CE0} (sus)	50*	75*	50	90*	V
With base open	V _{EB0}	7	7	6	7	V
*EMITTER TO BASE VOLTAGE	V _{EB0}	7	7	6	7	V
*CONTINUOUS COLLECTOR CURRENT	I _C	4	7	4	4	A
PEAK COLLECTOR CURRENT	I _{CM}	10	10	5	5	A
*CONTINUOUS BASE CURRENT	I _B	4	5	2	3	A
*TRANSISTOR DISSIPATION	P _T	35 (2N3878)	35	35	35	W
At case temperature (T _C) = 25°C		Derate linearly at 0.2 W/°C				
At case temperatures above 25°C		5.8 (40375)				
At ambient temperature (T _A) = 25°C		See Figs. 1, 2, 3, and 5				
For other conditions						
*TEMPERATURE RANGE		65 to 200				°C
Storage & operating (Junction)						
*PIN TEMPERATURE		235				°C
1/32 in. (0.8 mm) from seating plane for 10 ³ max.						

* In accordance with JEDEC registration data format JS-6 R0F-2 (2N3878); JS-6 R0F-1 (2N3879, 2N5202, 2N6500).

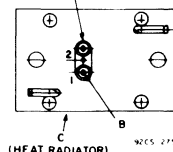
Features:

- Maximum-area-of-operation curves for dc and pulse operation
- Rated for safe operation in both forward- and reverse-bias conditions
- High sustaining voltage
- Total saturated transition time less than 1 μs for 2N3879, 2N5202, and 2N6500

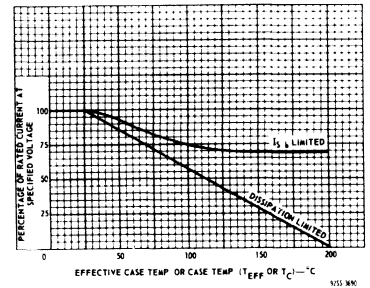
TERMINAL DESIGNATIONS



JEDEC TO-66
2N3878, 2N3879, 2N5202, 2N6500
92CS-27516



JEDEC TO-66 with Heat Radiator
40375
92CS-27525



Note: Use ambient temperature for derating 40375.
Fig. 2 - Dissipation derating for all types.

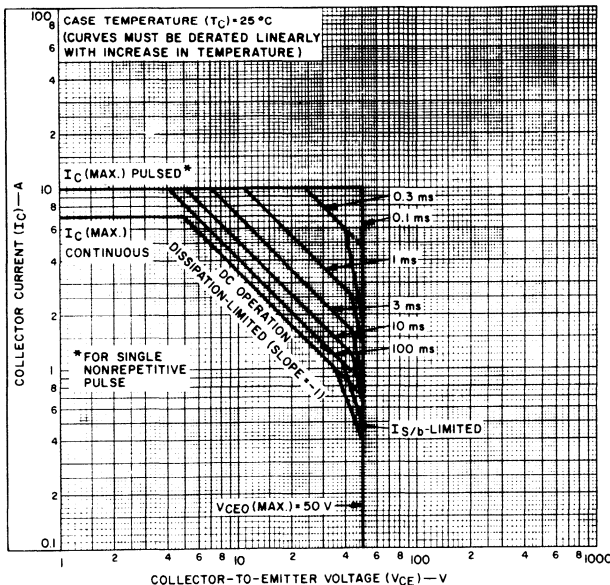


Fig. 1 - Maximum operating areas for 2N3878.

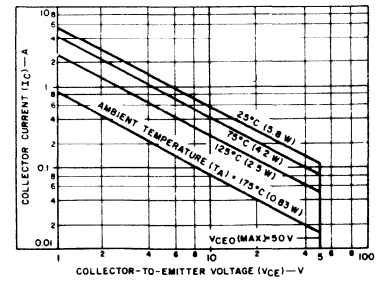


Fig. 3 - Maximum operating areas for 40375.

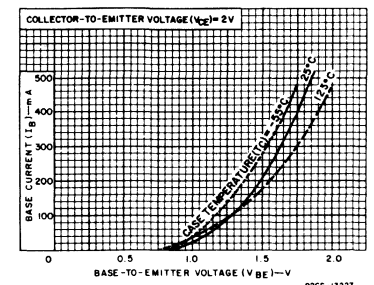


Fig. 4 - Typical input characteristics for all types.

2N3878, 2N3879, 2N5202, 2N6500, 40375

ELECTRICAL CHARACTERISTICS, At Case Temperature (T_C) = 25°C unless otherwise specified:

CHARACTERISTIC	SYMBOL	TEST CONDITIONS				LIMITS								UNITS
		VOLTAGE V _{dc}		CURRENT A _{dc}		2N3878 40375		2N3879		2N5202		2N6500		
		V _{CE}	V _{BE}	I _C	I _B	Min.	Max.	Min.	Max.	Min.	Max.	Min.	Max.	
Collector Cutoff Current: With base-emitter junction reverse-biased	I _{CEV}	100	-1.5			-	-	-	-	-	10	-	-	
		110	0			-	-	-	-	-	-	-	5	
With base-emitter junction reverse-biased and T _C = 150°C	I _{CEV}	100	-1.5			-	4	-	4	-	10	-	-	
		110	0			-	-	-	-	-	-	-	10	
With base open	I _{CEO}	40			0	-	5*	-	5	-	-	-	5	
		70			0	-	-	-	-	-	-	-	-	
Emitter Cutoff Current	I _{EBO}		-6 -7			-	-	-	-	-	10	-	25	
Collector-to-Emitter Sustaining Voltage With base open	V _{CEO(sus)}			0.2	0	50 ^a		75 ^a		50 ^a		90 ^a	V	
With external base-to-emitter resistance (R _{BE}) = 50 Ω	V _{CER(sus)}			0.2	0	65 ^a		90 ^a		75 ^a		110 ^a	V	
DC Forward Current Transfer Ratio	h _{FE}	1.2		4 ^b		40	200			10	100			
		2		0.5 ^b		40	200							
		2		3 ^b		8		12	100				15	
		2		4 ^b		20		20	80				60	
		5		4 ^b		20		20						
5		0.5 ^b		50	200		40							
Collector-to-Emitter Saturation Voltage	V _{CE(sat)}			3 ^b 4 ^b	0.3 0.4		2		1.2		1.2		1.5	
Base-to-Emitter Voltage	V _{BE}	2		4 ^b			2.5						V	
Base-to-Emitter Saturation Voltage	V _{BE(sat)}			3 ^b 4 ^b	0.3 0.4				2		2		2.5	
Collector-to-Base Output Capacitance: (f = 1 MHz, V _{CB} = 10 V)	C _{ob}						175		175		175		175	
Second Breakdown Collector Current With base forward-biased and 1-5 nonrepetitive pulse	I _{S(t)}	40				750		500		400		400	mA	
Second Breakdown Energy With base reverse-biased and R _{BE} = 50 Ω, V _{BB} = -4 V At L = 50 μH At L = 125 μH	E _{S(t)} ^c					1		1		0.4		0.5	mJ	
Magnitude of Common Emitter, Small-Signal, Short Circuit, Forward-Current Transfer Ratio (f = 10 MHz)	h _{FE}	10		0.5		4		4		6		6		
Common Emitter, Small Signal, Short Circuit, Forward-Current Transfer Ratio (f = 1 kHz)	h _{FE}	30		0.1		40								
Thermal Resistance: Junction-to-case	R _{θJC}					2N3878 5		5		5		5	°C/W	
Junction-to-ambient	R _{θJA}					40375 1.30								

^a In accordance with JEDEC registration data format JS-6, RDF-2 (2N3878); JS-6 RDF-1 (2N3879, 2N5202, 2N6500).

^b Pulsed, pulse duration = 300 μs, duty factor ≤ 2%.

^c CAUTION: Sustaining voltages V_{CEO(sus)} and V_{CER(sus)} MUST NOT be measured on a curve tracer.

^c E_{S(t)} is defined as the energy at which second breakdown occurs under specified reverse-bias conditions. E_{S(t)} = 1/2LI² where L is a series load or leakage inductance and I is the peak collector current.

TRANSITION AND STORAGE-TIME CHARACTERISTICS FOR SWITCHING TYPES, At Case Temperature (T_C) = 25°C:

CHARACTERISTIC	SYMBOL	TEST CONDITIONS			LIMITS						UNITS
		VOLTAGE V _{dc}		CURRENT A _{dc}	2N3879		2N5202		2N6500		
		V _{CC}	I _C	I _B	Min.	Max.	Min.	Max.	Min.	Max.	
Saturated Switching Time	t _d	30	3	0.3 ^a	-	-	-	-	-	40	
		30	4	0.4 ^a	-	40	-	-	-	-	
		30	4	0.8 ^a	-	-	-	40	-	-	
Delay time	t _r	30	3	0.3 ^a	-	-	-	-	-	400	
		30	4	0.4 ^a	-	400	-	-	-	-	
		30	4	0.8 ^a	-	-	-	400	-	-	
Rise time	t _s	30	3	0.3 ^a	-	-	-	-	-	1000	
		30	4	0.4 ^a	-	800	-	-	-	-	
		30	4	0.8 ^a	-	-	-	1200	-	-	
Storage time	t _f	30	3	0.3 ^a	-	-	-	-	-	500	
		30	4	0.4 ^a	-	400	-	-	-	-	
		30	4	0.8 ^a	-	-	-	400	-	-	

^a In accordance with JEDEC registration data format (JS-6, RDF-1)

^a I_{B1} = I_{B2}

2N3878, 2N3879, 2N5202, 2N6500, 40375

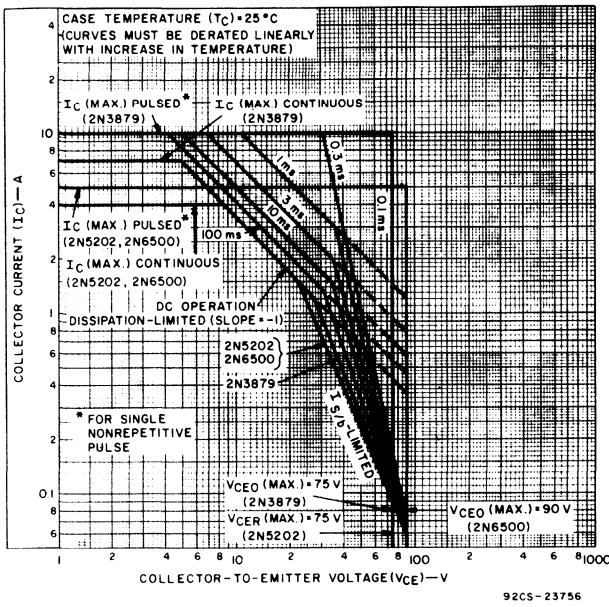


Fig. 5 - Maximum operating areas for 2N3879, 2N5202, and 2N6500.

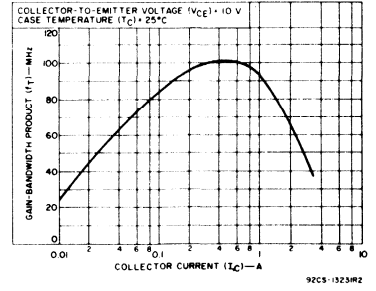


Fig. 6 - Typical gain-bandwidth product for all types.

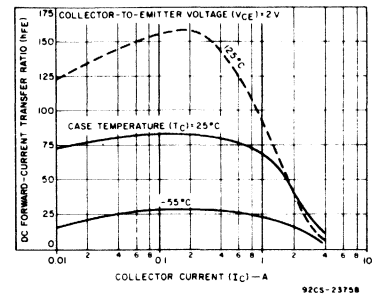


Fig. 7 - Typical dc beta characteristics for 2N6500.

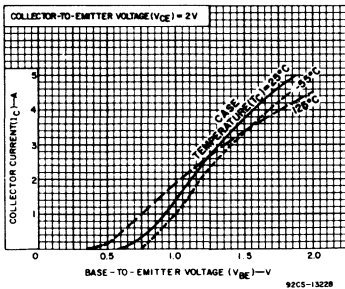


Fig. 8 - Typical transfer characteristics for all types.

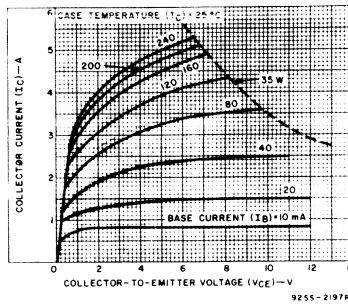


Fig. 9 - Typical output characteristics for 2N3878, 2N3879, 2N5202 and 40375.

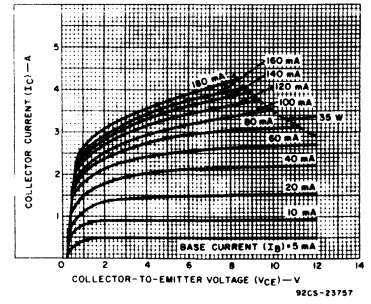


Fig. 10 - Typical output characteristics for 2N6500.

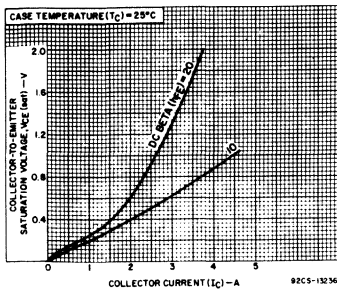


Fig. 11 - Typical saturation-voltage characteristics for 2N3878, and 2N3879.

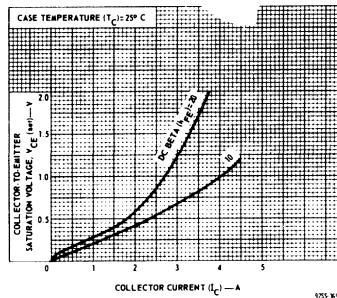


Fig. 12 - Typical saturation-voltage characteristics for 2N5202.

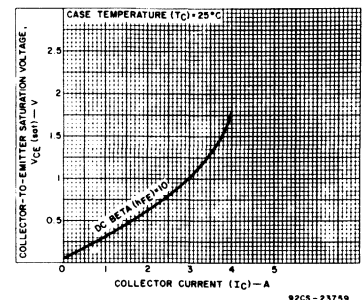


Fig. 13 - Typical saturation-voltage characteristics for 2N6500.

2N3878, 2N3879, 2N5202, 2N6500, 4305

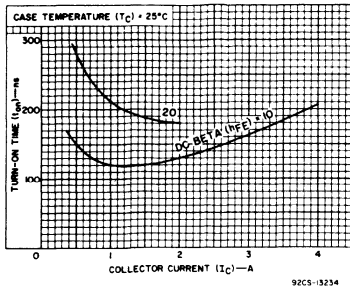


Fig. 14 - Typical turn-on time for 2N3879, 2N5202, and 2N6500.

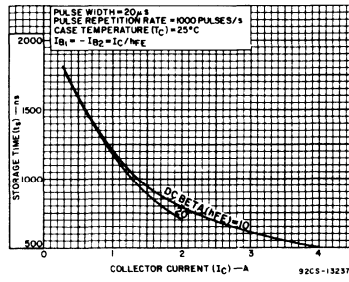


Fig. 15 - Typical storage time for 2N3879, 2N5202, and 2N6500.

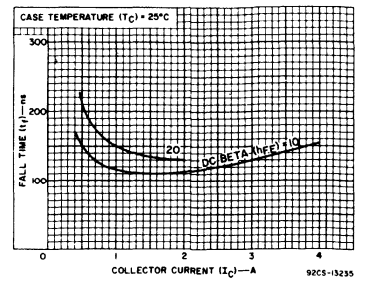


Fig. 16 - Typical fall time for 2N3879, 2N5202, and 2N6500.

2N4036, 2N4037, 2N4314, 40391, 40394, 41503

Medium-Power Silicon P-N-P Planar Transistors

General-Purpose Types for Industrial and Commercial Applications

These RCA types are double-diffused, epitaxial-planar, silicon p-n-p transistors; they differ in breakdown-voltage ratings, leakage-current, and saturation characteristics.

The 2N4036, 2N4037, 2N4314, 40391, and 40394 transistors are intended for a wide variety of small-signal medium-power applications. With a minimum gain-bandwidth product (f_T) of 60 MHz, these devices provide useful gain at high frequencies. In addition, the 2N4036 is useful in high-speed saturated switching applications.

Type 41503 is suitable for low-power, low-cost industrial and audio uses, and may be employed as the p-n-p complement to RCA n-p-n type 41502.

Types 2N4036, 2N4037, 2N4314, and 41503 are supplied in the JEDEC TO-39 hermetic package. The 40391 is a 2N4037 with a factory attached heat radiator, intended for printed-circuit-board applications. Type 40394 is a 2N4037 with a factory-attached diamond-shaped mounting flange.

Features:

- 2N4036 } are p-n-p } 2N2102
- 2N4037 } complements of } 2N3053
- Gain-bandwidth product (f_T) = 60 MHz min.
- High breakdown voltages
- Maximum-area-of-operation curves
- Planar construction provides low noise and low leakage
- Low saturation voltages
- High pulsed beta at high collector current
- Fast switching (2N4036)

MAXIMUM RATINGS, Absolute Maximum Values:

	2N4036	2N4037 40391, 40394	2N4314	41503
*COLLECTOR-TO-BASE VOLTAGE V_{CBO}	-90	-60	-90	-
COLLECTOR-TO-EMITTER SUSTAINING VOLTAGE:				
With 1.5 volts (V_{BE}) of reverse bias $V_{CEV(sus)}$	-85	-60	-85	-
With external base-to-emitter resistance				
$(R_{BE}) \leq 200\Omega$ $V_{CER(sus)}$	-85	-60	-85	-
With base open $V_{CEO(sus)}$	-65	-40	-65	-30
*EMITTER-TO-BASE VOLTAGE V_{EBO}	-7	-7	-7	-4
*COLLECTOR CURRENT I_C	-1.0	-1.0	-1.0	-1
*BASE CURRENT I_B	-0.5	-0.5	-0.5	-0.5
*TRANSISTOR DISSIPATION P_T				
At case temperatures up to 25°C	7	7(2N4037)	7	7
At temperatures above 25°C	-	7(40394)	-	-
Derate linearly to 200°C	1	3.5(40391)	1	1
At case temperatures up to 25°C	-	1(2N4037, 40394)	-	-
Derate linearly to 200°C				
*TEMPERATURE RANGE:				
Storage & Operating (Junction)			-65 to 200	°C
*LEAD TEMPERATURE (During soldering):				
At distance $\geq 1/16$ in. (1.58 mm)			230	°C
from seating plane for 10 s max.				

* In accordance with JEDEC registration data format: US-6 RDF-1 2N4036, JS-9 RDF-2 2N4037, 2N4314.

TERMINAL DESIGNATIONS

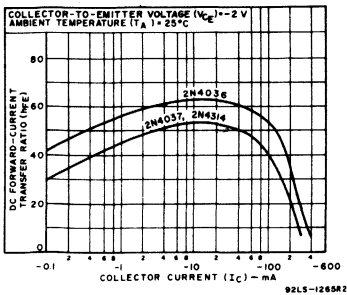
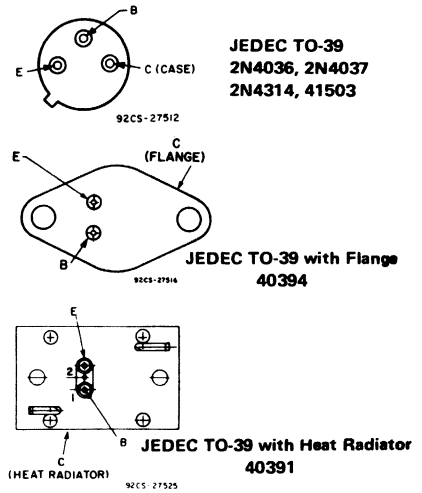


Fig.1—Typical dc-beta characteristics for 2N4036, 2N4037 and 2N4314.

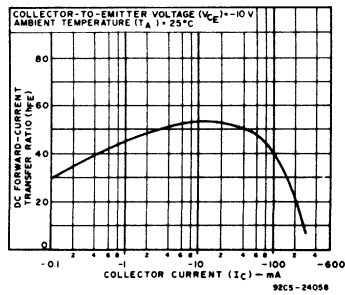


Fig.2—Typical dc-beta characteristic for 41503.

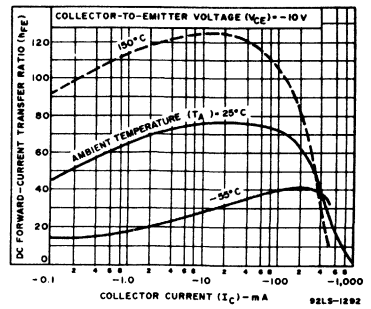


Fig.3—Typical dc beta characteristics for 2N4037 and 2N4314.

2N4036, 2N4037, 2N4314, 40391, 40394, 41503

ELECTRICAL CHARACTERISTICS, at Case Temperature (T_C) = 25°C Unless Otherwise Specified

CHARACTERISTIC	SYMBOL	TEST CONDITIONS				LIMITS								UNITS	
		VOLTAGE V dc		CURRENT mA dc		2N4036		2N4037 40391 40394		2N4314		41503			
		V_{CB}	V_{CE}	V_{BE}	I_C	MIN.	MAX.	MIN.	MAX.	MIN.	MAX.	MIN.	MAX.		
Collector Cutoff Current: With emitter open	I_{CBO}	-15 -90 -60				-	-0.1 ^a -0.02	-	-	-	-	-	-2	μA mA	
With base open	I_{CEO}		-30			-	-0.05 ^a	-	-5 ^a	-	-5 ^a	-		μA	
With base-emitter junction reverse biased	I_{CEX}		-85	1.5		-	-100 ^a -0.1 ^a	-	-	-	-	-		mA	
		$T_C = 150^\circ C$													
Emitter Cutoff Current	I_{EBO}		7 5	0 0		-	-0.1 ^a -0.02	-	-1 ^a	-	-1 ^a	-		mA μA	
Collector-to-Base Breakdown Voltage ($I_E = 0$)	$V_{(BR)CBO}$				-0.1	-90	-	-60 ^a	-	-90 ^a	-	-		V	
Emitter-to-Base Breakdown Voltage ($I_E = -0.1$ mA)	$V_{(BR)EBO}$				0	-7	-	-7	-	-7	-	-4		V	
Collector-to-Emitter Sustaining Voltage: With base-emitter junction reverse biased	$V_{CEV(sus)}$			1.5	-100	-85 ^a	-	-60 ^a	-	-85 ^a	-	-		V	
With external base-to- emitter resistance (R_{BE}) < 200 Ω	$V_{CER(sus)}$				-100	-85 ^a	-	-60 ^a	-	-85 ^a	-	-		V	
With base open	$V_{CEO(sus)}$				-30 -100	-65 ^a -100	-	-40 ^a	-	-65 ^a	-	-30 ^a		V	
Collector-to-Emitter Voltage ($I_E = -15$ mA)	$V_{CE(sat)}$				-150	-	-0.65	-	-1.4	-	-1.4	-	-1.5	V	
Base-to-Emitter Voltage ($I_E = -15$ mA)	$V_{BE(sat)}$				-10	-150	-	-1.1	-	-1.5 ^a	-	-1.5 ^a	-	-2.5	V
DC Forward-Current Transfer Ratio	h_{FE}				-2 -10 -10 -10	-150 -0.1 -1.0 -150 ^b -500 ^b	20 20 -	200 20 -	-	-	15 15	250 50 250	20		
Common-Emitter, Small-Signal Short-Circuit, Forward- Current Transfer Ratio (at $f = 20$ MHz)	h_{fe}				-10	-50	3	3	3	3	-	-	-		
Magnitude of Common-Emitter, Small-Signal, Short-Circuit, Forward-Current Transfer Ratio (at $f = 20$ MHz)	$ h_{fe} $				-10	-50	3	3	10	3	10	-	-		
Collector-Base Capacitance (at $f = 1$ MHz, $I_E = 0$)	C_{cb}				-10	-	30	30 ^a	30 ^a	30	30	30		pF	
Input Capacitance	C_{ib}					0.5	0	90	90	90	90	90		pF	
Sat. Switching Time ^c															
Rise time	t_r		-30			-150		70							
Storage time	t_s		-30			-150		600							
Fall time	t_f		-30			-150		100						75	
Turn-on time	t_{on}		-30			-150		110							
Turn-off time	t_{off}		-30			-150		700							
Thermal Resistance:															
Junction-to-Case	$R_{\theta JC}$							25 ^a	25 (max.) 2N4037 & 40394		25		25	$^{\circ}C/W$	
Junction-to-Ambient	$R_{\theta JA}$							165	165 (max.) 2N4037 40394 50 (max.) 40391		165		165		

^a CAUTION: The sustaining voltages $V_{CEO(sus)}$, $V_{CER(sus)}$, and $V_{CEV(sus)}$ MUST NOT be measured on a curve tracer.

^b Pulsed, pulse duration = 300 μs , duty factor < 2%.

^c In accordance with JEDEC registration data format JS-6 RFD-1 2N4036; JS-9 RFD-2 2N4037, 2N4314.

^d $I_{B1} = I_{B2} = 15$ mA

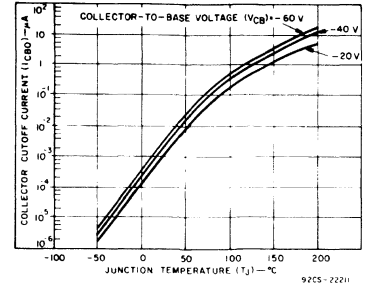


Fig. 4—Typical collector-cutoff current vs. junction temperature for 2N4036.

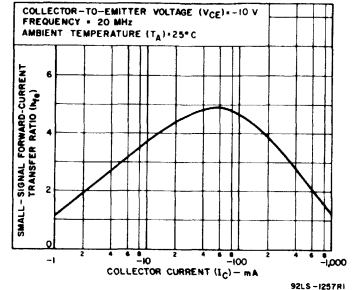


Fig. 5—Typical small-signal beta characteristics for all types.

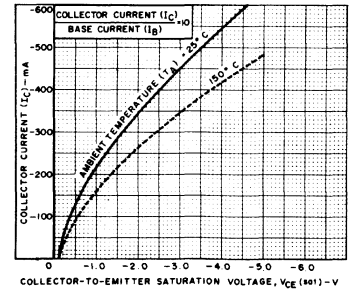


Fig. 6—Typical saturation-voltage characteristics for 2N4036.

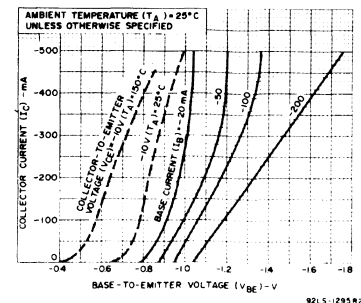


Fig. 7—Typical transfer characteristics for 2N4037 and 2N4314.

2N4036, 2N4037, 2N4314, 40391, 40394, 41503

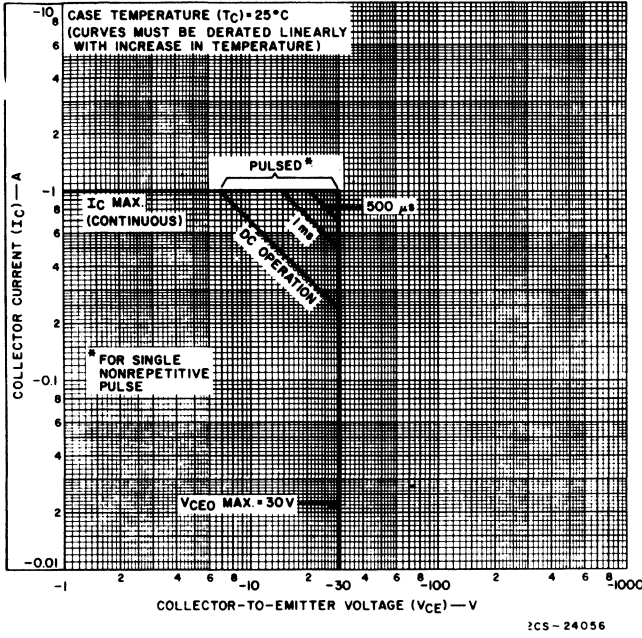


Fig.8—Maximum operating areas for 41503.

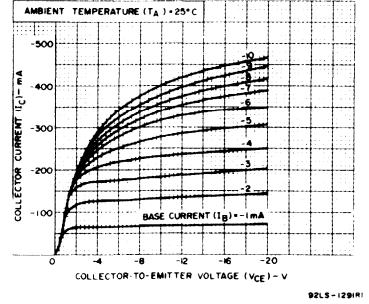


Fig.10—Typical large-signal output characteristics for 2N4037, 2N4314, 40391, and 40394.

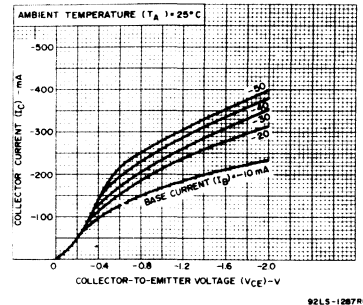


Fig.11—Typical small-signal output characteristics for 2N4037, 2N4314, 40391, and 40394.

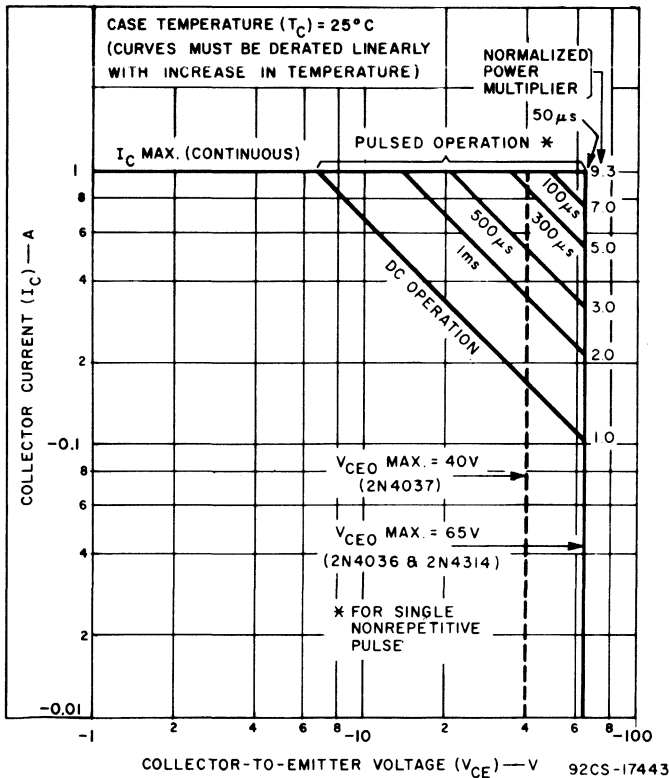


Fig.9—Maximum operating areas for 2N4036, 2N4037, and 2N4314.

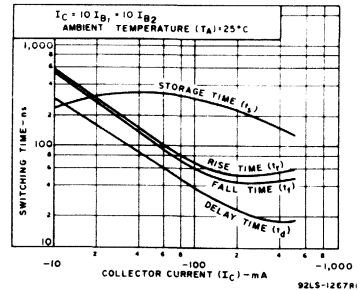


Fig.12—Typical saturated switching times for 2N4036.

2N4231A, 2N4232A, 2N4233A, 2N6312, 2N6313, 2N6314

Silicon N-P-N and P-N-P Medium-Power Transistors

General-Purpose Types for Switching Applications

RCA-2N4231A, 2N4232A, and 2N4233A are multiple-epitaxial n-p-n transistors. The RCA-2N6312, 2N6313, and 2N6314 are multiple-epitaxial p-n-p transistors. They are

complements to 2N4231A, 2N4232A, and 2N4233A. These types are supplied in lead JEDEC TO-213MA hermetic packages.

Features:

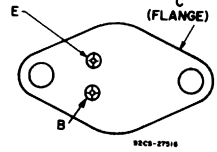
- 2N4231A–2N4233A complements of 2N6312–2N6314
- Low saturation voltages
- Maximum-safe-area-of-operation curves
- Thermal-cycle ratings
- High gain at high current

MAXIMUM RATINGS, Absolute-Maximum Values:

	N-P-N 2N4231A	2N4232A	2N4233A	
	P-N-P 2N6312♦	2N6313♦	2N6314♦	
* V_{CBO}	40	60	80	V
$V_{CEO(sus)}$	40	60	80	V
* V_{EBO}	5	5	5	V
* I_C (2N4231A, 2N4232A, 2N4233A) (2N6312, 2N6313, 2N6314)	_____	3	_____	A
		5	_____	A
* I_{CM} (Registered for 2N6312, 13, 14 only)	_____	10	_____	A
* I_B (2N4231A, 2N4233A, 2N4233A) (2N6312, 2N6313, 2N6314)	_____	1	_____	A
		2	_____	A
* P_T $T_C \leq 25^\circ C$	_____	75	_____	W
$T_C > 25^\circ C$ derate linearly	_____	0.43	_____	W/°C
* T_J, T_{stg} (2N4231A, 2N4232A, 2N4233A) (2N6312, 2N6313, 2N6314)	_____	-55 to 200	_____	°C
		-65 to 200	_____	°C
* T_L (2N6312, 2N6313, 2N6314 only) At distances $\geq 1/32$ in. (0.8 mm) from seating plane for 10 s max.	_____	235	_____	°C

* In accordance with JEDEC registration data.
♦ For p-n-p devices, voltage and current values are negative.

TERMINAL DESIGNATIONS



JEDEC TO-213MA

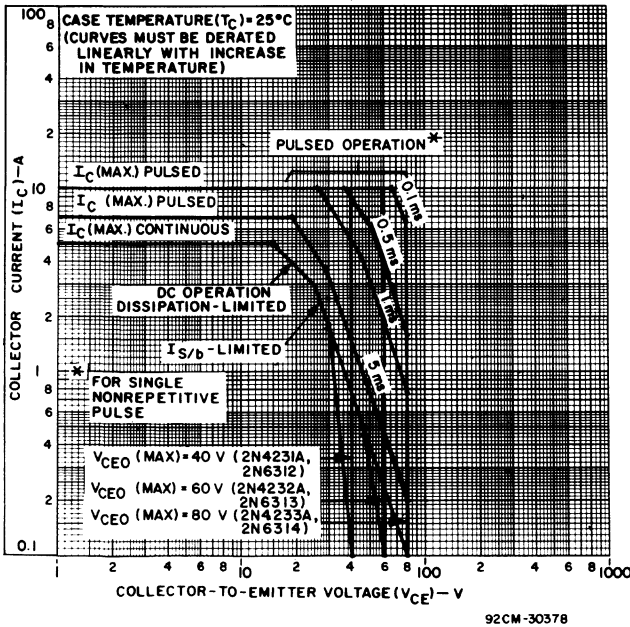


Fig. 1 – Maximum operating areas for all types.♦

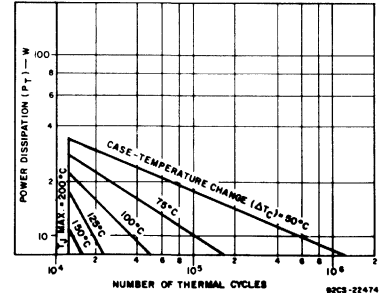


Fig. 2 – Thermal-cycling rating chart for all types.

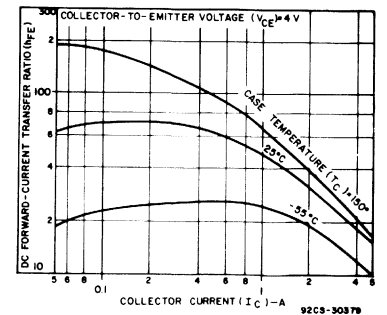


Fig. 3 – Typical dc beta characteristics for 2N4231A, 2N4232A, and 2N4233A.

♦ For p-n-p devices, voltage and current values are negative.

2N4231A, 2N4232A, 2N4233A, 2N6312, 2N6313, 2N6314

ELECTRICAL CHARACTERISTICS, At Case Temperature (T_C) = 25°C unless otherwise specified

CHARACTERISTIC	TEST CONDITIONS				LIMITS						UNITS	
	VOLTAGE		CURRENT		2N4231A 2N6312		2N4232A 2N6313		2N4233A 2N6314			
	V _{CE}	V _{BE}	I _C	I _B	Min.	Max.	Min.	Max.	Min.	Max.		
* I _{CBO}	40 ^a 60 ^a 80 ^a				—	50	—	—	—	—	50	μA
* I _{CEX} R _{BE} = 100 Ω	40 60 80	-1.5 -1.5 -1.5			—	100	—	—	100	—	—	μA
* R _{BE} = 100 Ω, T _C = 150°C	40 60 80	-1.5 -1.5 -1.5			—	1	—	—	1	—	—	mA
* I _{CEO}	30 50 70			0 0 0	—	1	—	—	1	—	—	mA
* I _{EBO}		-5			—	0.5	—	0.5	—	0.5		mA
* h _{FE} 2N4231A, 2N4232A, 2N4233A	2 2 2		3 ^c 1.5 ^c 0.5 ^c		10 25 40	—	10 100 40	—	10 100 40	—	—	
2N6312, 2N6313, 2N6314	4 4 4 4		5 ^c 3 ^c 1.5 ^c 0.5 ^c		4 10 25 40	—	4 10 25 40	—	4 10 25 40	—	—	
* V _{BE} 2N4231A, 2N4232A, 2N4233A 2N6312, 2N6313, 2N6314	2 2 4		1.5 ^c 1.5 ^c		— —	1.4	— —	1.4	— —	1.4	— —	V
* V _{CE(sat)} 2N4231A, 2N4232A, 2N4233A			3 ^c 1.5 ^c	0.3 0.15	— —	2 0.7	— —	2 0.7	— —	2 0.7	— —	V
2N6312, 2N6313, 2N6314			5 ^c 3 ^c 1.5 ^c	1.25 0.3 0.15	— — —	4 2 0.7	— — —	4 2 0.7	— — —	4 2 0.7	— — —	V
* V _{CEO(sus)} ^b			0.1 ^c	0	40	—	60	—	80	—	—	V
* h _{feL} f = 1 MHz	10		0.5		4	—	4	—	4	—	—	
* h _{fe} f = 1 kHz	10		0.5		20	—	20	—	20	—	—	
* f _T	10		0.5		4	—	4	—	4	—	—	MHz
* C _{obo} f = 0.1 MHz 2N4231A, 2N4233A, 2N4233A 2N6312, 2N6313, 2N6314	10 ^a 10 ^a				— —	200 300	— —	200 300	— —	200 300	— —	pF
R _{θJC}					—	2.3	—	2.3	—	2.3	—	°C/W

- * In accordance with JEDEC registration data format.
- ♦ For p-n-p devices, voltage and current values are negative.
- ^a V_{CB} value.
- CAUTION:** Sustaining voltages V_{CEO(sus)} *MUST NOT* be measured on a curve tracer.
- ^c Pulsed, pulse duration = 300 μs, duty factor = 1.8%.

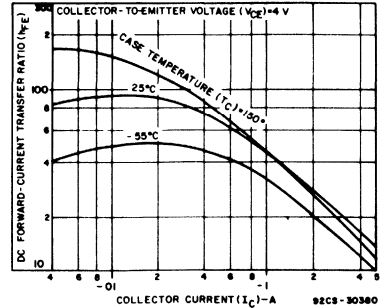


Fig. 4 - Typical dc beta characteristics for 2N6312, 2N6313, and 2N6314.

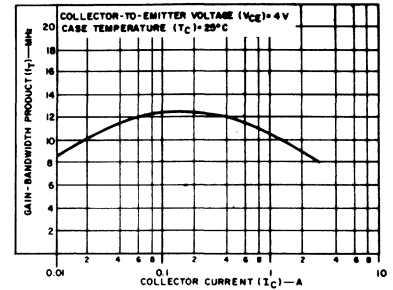


Fig. 5 - Typical gain-bandwidth product for all types. ♦

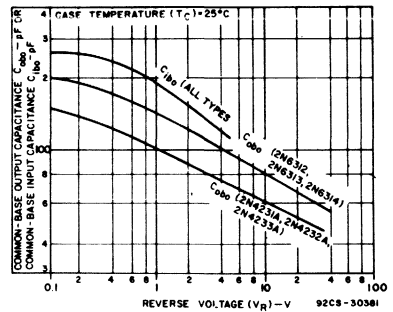


Fig. 6 - Typical common-base input or output capacitance characteristics as a function of reverse voltage for all types. ♦

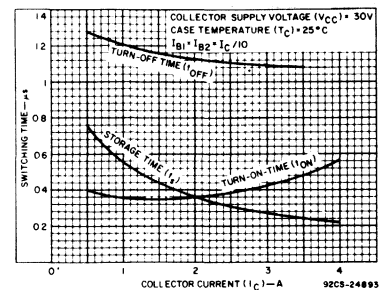


Fig. 7 - Typical saturated switching characteristics for 2N4231A, 2N4232A, and 2N4233A.

♦ For p-n-p devices, voltage and current values are negative.

2N4231A, 2N4232A, 2N4233A, 2N6312, 2N6313, 2N6314

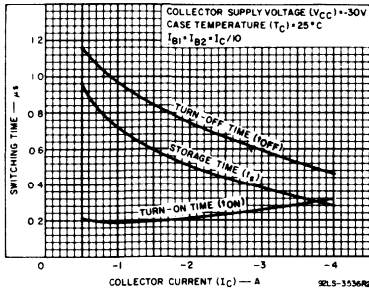


Fig. 8 — Typical saturated switching characteristics for 2N6312, 2N6313, and 2N6314.

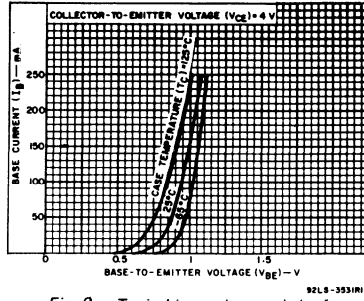


Fig. 9 — Typical input characteristics for all types. ♦

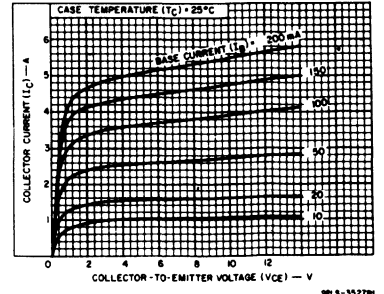


Fig. 10 — Typical output characteristics for all types. ♦

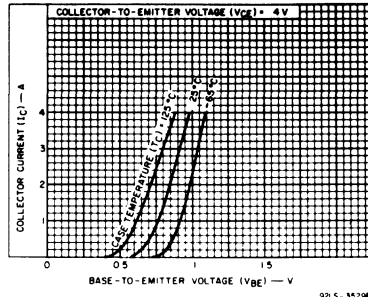


Fig. 11 — Typical transfer characteristics for all types. ♦

♦ For p-n-p devices, voltage and current values are negative.

2N4904, 2N4905, 2N4906

Silicon P-N-P Epitaxial-Base High-Power Transistors

Rugged, Broadly Applicable Devices
For Industrial and Commercial Use

The RCA-2N4904, 2N4905 and 2N4906 are epitaxial-base silicon p-n-p transistors featuring high-gain at high current. They may be used as complements to the 2N4913, 2N4914 and 2N4915 n-p-n types, respectively. These devices are intended for medium-speed switching and amplifier applications

and feature a dissipation capability of 87.5 watts at case temperatures up to 25°C.

They differ in voltage ratings and in the currents at which the parameters are controlled. All are supplied in the steel JEDEC TO-204MA hermetic package.

Features:

- High dissipation capability
- Low saturation voltages
- Maximum safe-area-of-operation curves
- Hermetically sealed JEDEC TO-3/TO-204MA package
- High gain at high current
- Thermal-cycling rating curve

Applications:

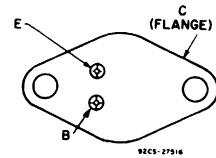
- Series and shunt regulators
- High-fidelity amplifiers
- Power-switching circuits
- Solenoid drivers

MAXIMUM RATINGS, Absolute-Maximum Values:

	2N4904	2N4905	2N4906	
• V_{CEO}	-40	-60	-80	V
• V_{CBO}	-40	-60	-80	V
• V_{EBO}	-5	-5	-5	V
• I_C	-5	-5	-5	A
• I_B	-1	-1	-1	A
• P_T				
At $T_C \leq 25^\circ C$	87.5	87.5	87.5	W
At $T_C > 25^\circ C$	derate linearly			0.5 W/°C
• T_J, T_{stg}				-65 to 200 °C
• T_L at 1/16 ± 1/32 in. (1.58 ± 0.8 mm) from case for 10 s				235 °C

* In accordance with JEDEC registration data.

TERMINAL DESIGNATIONS



JEDEC TO-204MA

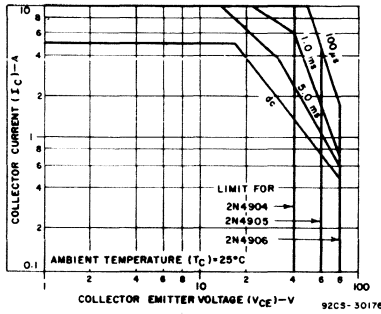


Fig. 1 - Maximum operating areas for all types.

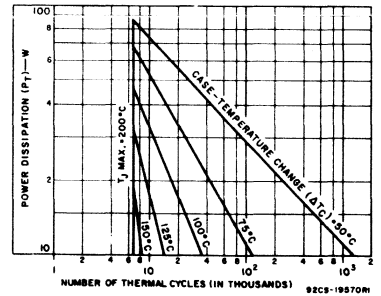


Fig. 2 - Thermal-cycling rating chart.

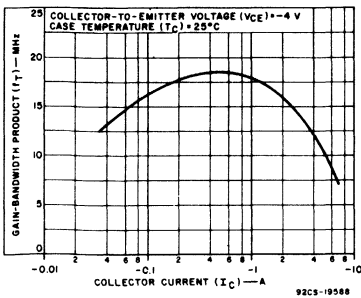


Fig. 3 - Typical gain-bandwidth product for all types.

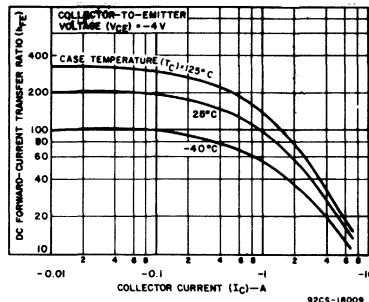


Fig. 4 - Typical dc beta characteristics for all types.

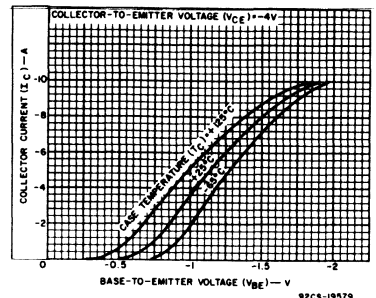


Fig. 5 - Typical transfer characteristics for all types.

2N4904, 2N4905, 2N4906

ELECTRICAL CHARACTERISTICS, At Case Temperature $T_C = 25^\circ\text{C}$
Unless Otherwise Specified

CHARACTERISTIC	TEST CONDITIONS				LIMITS						UNITS	
	Voltage V dc		Current A dc		2N4904		2N4905		2N4906			
	V_{CE}	V_{BE}	I_C	I_B	Min.	Max.	Min.	Max.	Min.	Max.		
I_{CEX}	-40	1.5	-	-	-	-0.1	-	-	-	-	mA	
	-60	1.5	-	-	-	-	-	-0.1	-	-		
	-80	1.5	-	-	-	-	-	-	-	-0.1		
	$T_C = 150^\circ\text{C}$		-40	1.5	-	-	-	-	-	-		-
			-60	1.5	-	-	-	-	-2	-		-
			-80	1.5	-	-	-	-	-	-		-2
I_{CEO}	-40	-	-	0	-	-1	-	-	-	-	mA	
	-60	-	-	0	-	-	-	-1	-	-		
	-80	-	-	0	-	-	-	-	-	-1		
I_{CBO} $I_E = 0$	40 $^\circ\text{C}$	-	-	-	-	-0.1	-	-	-	-	mA	
	60 $^\circ\text{C}$	-	-	-	-	-	-	-0.1	-	-		
	80 $^\circ\text{C}$	-	-	-	-	-	-	-	-	-0.1		
I_{EBO}	-	5	0	-	-	-1	-	-1	-	-1	mA	
$V_{CEO(sus)}^b$	-	-	-0.2	0	-40	-	-60	-	-80	-	V	
h_{FE}^a	-2	-	-2.5	-	25	100	25	100	25	100		
	-2	-	-5	-	7	-	7	-	7	-		
V_{BE}^a	-2	-	-2.5	-	-	-1.4	-	-1.4	-	-1.4	V	
$V_{CE(sat)}^a$	-	-	-2.5	-0.25	-	-1	-	-1	-	-1	V	
	-	-	-5	-1	-	-1.5	-	-1.5	-	-1.5		
f_T f=1 MHz	-10	-	-1	-	4	-	4	-	4	-	MHz	
h_{fe} f=1 kHz	-10	-	-0.5	-	40	-	40	-	40	-		
$R_{\theta JC}$	-	-	-	-	-	2	-	2	-	2	$^\circ\text{C/W}$	

* In accordance with JEDEC registration data.

^a Pulsed: pulse duration = 300 μs , duty factor = 2%.

^b CAUTION: Sustaining voltage, $V_{CEO(sus)}$, MUST NOT be measured on a curve tracer.

^c V_{CB} .

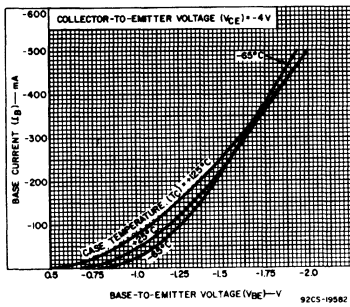


Fig. 6 – Typical input characteristics for all types.

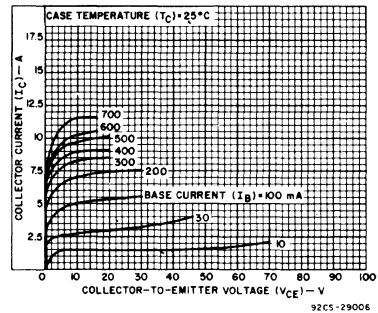


Fig. 7 – Typical output characteristics for all types.

2N4913, 2N4914, 2N4915

Silicon N-P-N Epitaxial-Base High-Power Transistors

Rugged, Broadly Applicable Devices
For Industrial and Commercial Use

The RCA-2N4913, 2N4914, and 2N4915 are epitaxial-base silicon n-p-n transistors featuring high-gain at high current. They may be used as complements to the 2N4904, 2N4905, and 2N4906 p-n-p types respectively. These devices are intended for medium-speed switching and feature a dissipation

capability of 87.5 watts at case temperature up to 25°C.

They differ in voltage ratings and in the currents at which the parameters are controlled. All are supplied in the steel JEDEC TO-204MA hermetic package.

Features:

- High dissipation capability
- Low saturation voltages
- Maximum safe-areas-of-operation curves
- Hermetically sealed JEDEC TO-3/TO-204MA package
- High gain at high current
- Thermal-cycling rating curve

Applications:

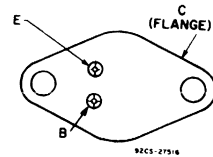
- Series and shunt regulators
- High-fidelity amplifiers
- Power-switching circuits
- Solenoid drivers

MAXIMUM RATINGS, Absolute-Maximum Values:

	2N4913	2N4914	2N4915	
* V_{CE0}	40	60	80	V
* V_{CBO}	40	60	80	V
* V_{EBO}	5	5	5	V
* I_C	5	5	5	A
* I_B	1	1	1	A
* P_T				
At $T_C < 25^\circ\text{C}$	87.5	87.5	87.5	W
At $T_C > 25^\circ\text{C}$	derate linearly		0.5	W/°C
* T_L	At 1/16 in. \pm 1/32 in. (1.58 mm \pm 0.8 mm) from case for 10 s		235	°C
* T_j, T_{stg}	-65 to 200			°C

* In accordance with JEDEC registration data.

TERMINAL DESIGNATIONS



JEDEC TO-204MA

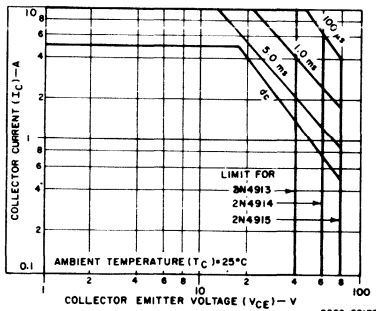


Fig. 1 - Maximum operating areas for all types.

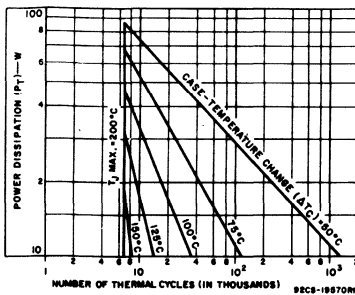


Fig. 2 - Thermal-cycling rating chart.

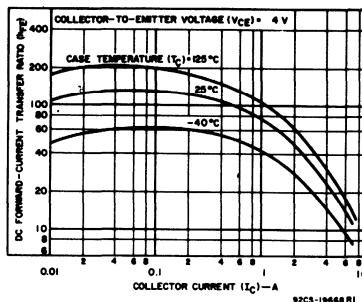


Fig. 3 - Typical dc beta characteristics for all types.

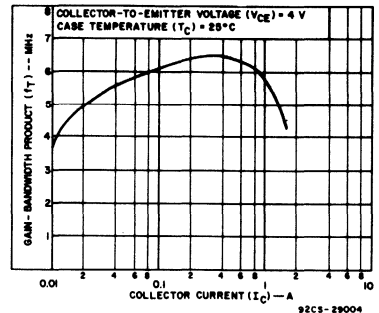


Fig. 4 - Typical gain bandwidth product for all types.

2N4913, 2N4914, 2N4915

ELECTRICAL CHARACTERISTICS, at Case Temperature $T_C = 25^\circ\text{C}$ Unless Otherwise Specified

CHARACTERISTIC	TEST CONDITIONS				LIMITS						UNITS	
	VOLTAGE		CURRENT		2N4913		2N4914		2N4915			
	V dc	V dc	A dc	A dc	MIN.	MAX.	MIN.	MAX.	MIN.	MAX.		
* I_{CEX}	40	-1.5	-	-	-	0.1	-	-	-	-	mA	
	60	-1.5	-	-	-	-	-	0.1	-	-		
	80	-1.5	-	-	-	-	-	-	-	0.1		
	T _C = 150°C											
	40	-1.5	-	-	-	2	-	-	-	-		-
	60	-1.5	-	-	-	-	-	2	-	-		-
* I_{CEO}	40	-	-	0	-	1	-	-	-	-	mA	
	60	-	-	0	-	-	-	1	-	-		
	80	-	-	0	-	-	-	-	-	1		
I_{CBO}	40°C	-	-	-	-	1	-	-	-	-	mA	
	60°C	-	-	-	-	-	-	1	-	-		
	80°C	-	-	-	-	-	-	-	-	1		
* I_{EBO}	-	5	-	-	-	1	-	1	-	1	mA	
* $V_{CEO(sus)}^b$	-	-	0.2	0	40	-	60	-	80	-	V	
* h_{FE}^a	2	-	2.5	-	25	100	25	100	25	100		
	2	-	5	-	7	-	7	-	7	-		
* V_{BE}^a	2	-	2.5	-	-	1.4	-	1.4	-	1.4	V	
* $V_{CE(sat)}^a$	-	-	2.5	0.25	-	0.75	-	0.75	-	0.75	V	
	-	-	5	1	-	1.5	-	1.5	-	1.5		
* f_T f = 1 MHz	10	-	1	-	4	-	4	-	4	-	MHz	
* h_{fe} f = 1 kHz	10	-	0.5	-	20	-	20	-	20	-		
$R_{\theta JC}$	-	-	-	-	-	2	-	2	-	2	°C/W	

* In accordance with JEDEC registration data.

^a Pulsed; pulse duration = 300 μs, Duty factor = 2%.

^b CAUTION: Sustaining voltage, $BV_{CEO(sus)}$, *MUST NOT BE* measured on a curve tracer.

^c V_{CB}

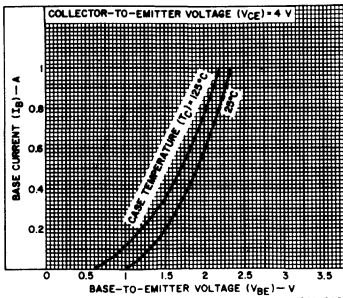


Fig. 5 - Typical input characteristics for all types.

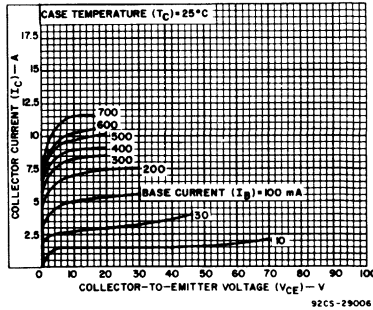


Fig. 6 - Typical output characteristics for all types.

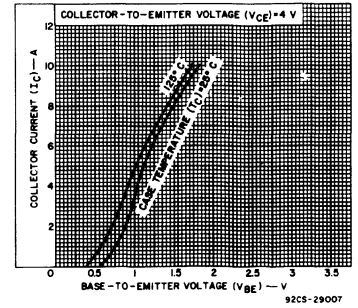


Fig. 7 - Typical transfer characteristics for all types.

2N5038, 2N5039, 2N6354, 2N6496

High-Current, High-Power, High-Speed Silicon N-P-N Power Transistors

Devices for Switching and Amplifier Circuits in Industrial and Commercial Applications

RCA-2N5038, 2N5039, 2N6354, and 2N6496 are epitaxial silicon n-p-n power transistors. They differ in breakdown-voltage ratings, leakage-current, and dc-beta values

The high current-handling capability of these transistors in conjunction with fast

switching speeds make these devices especially suited for switching-control amplifiers, power gates, switching regulators, converters, and inverters. Other recommended applications include dc-rf amplifiers and power oscillators. These transistors are supplied in the JEDEC TO-3 package.

Features:

- Maximum operating area curves for dc and pulse operation
- I_S/b -limit line beginning at 28 V
- High collector current ratings
- High-dissipation capability
- Fast switching speeds — Measured at: 5 A, 8 A, 10 A, 12 A levels

MAXIMUM RATINGS, Absolute Maximum Values:

	2N5038	2N5039	2N6354	2N6496	
*COLLECTOR-TO-BASE VOLTAGE	150	120	150	150	V
COLLECTOR-TO-EMITTER SUSTAINING VOLTAGE: With -1.5 volts (V_{BE}) of reverse bias and external base-to-emitter resistance (R_{BE}) = 100Ω	$V_{CE(sus)}$	150	120	—	V
* With external base-to-emitter resistance (R_{BE}) = 500Ω, L = 7mH	V_{CEX}	—	—	130	V
With $R_{BE} < 50\Omega$	$V_{CER(sus)}$	110	95	—	V
With base open	$V_{CEO(sus)}$	90	75	120	V
*EMITTER-TO-BASE VOLTAGE	V_{EBO}	7	7	6.5	7
*CONTINUOUS COLLECTOR CURRENT	I_C	20	20	10	15
*PEAK COLLECTOR CURRENT	I_{CM}	30	30	12	—
*CONTINUOUS BASE CURRENT	I_B	5	5	5	5
*TRANSISTOR DISSIPATION: At case temperatures up to 25°C and V_{CE} up to 28 V	P_T	140	140	140	140
At case temperature of 100°C and V_{CB} of 20 V		80	80	80	80
At case temperatures above 25°C		— Derate linearly to 200°C			
*TEMPERATURE RANGE: Storage & Operating (Junction)		— -65 to 200			°C
PIN TEMPERATURE (During soldering) At distances > 1/32 in. (0.8 mm) from seating plane for 10 s max.		— 230			

* In accordance with JEDEC registration data format (JIS-6, RDP-1)

TERMINAL DESIGNATIONS

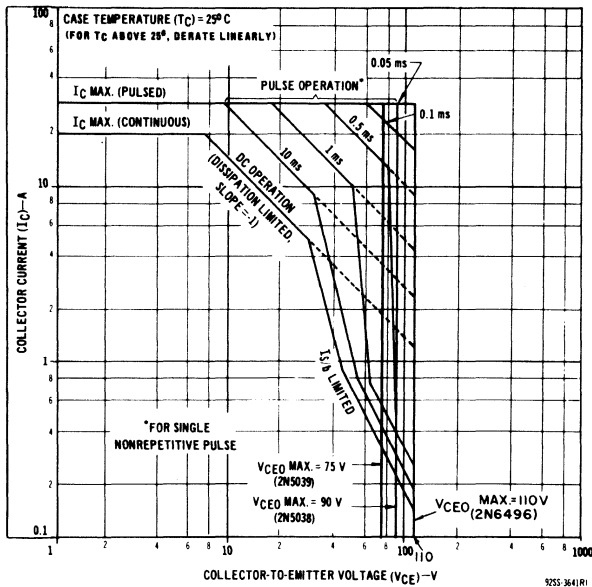
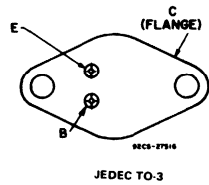


Fig. 1 — Maximum operating areas for 2N5038, 2N5039, 2N6496.

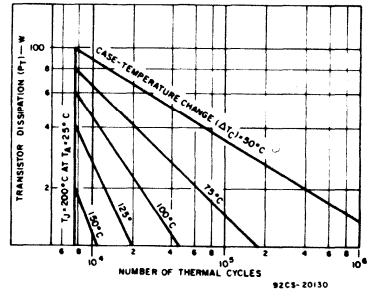


Fig. 2 — Thermal-cycling rating chart for all types.

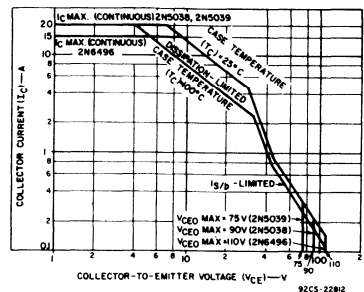


Fig. 3 — Maximum operating areas for 2N5038, 2N5039, 2N6496.

2N5038, 2N5039, 2N6354, 2N6496

ELECTRICAL CHARACTERISTICS, At Case Temperature (T_C) = 25°C Unless Otherwise Specified

CHARACTERISTICS	SYMBOL	TEST CONDITIONS				LIMITS								UNITS
		VOLTAGE		CURRENT		2N5038		2N5039		2N6354		2N6496		
		V dc	V dc	A dc	A dc	MIN.	MAX.	MIN.	MAX.	MIN.	MAX.	MIN.	MAX.	
Collector-Cutoff Current: With emitter open $V_{CB} = 150\text{ V}$	I_{CBO}										5			mA
With base open	I_{CEO}	55 70 100		0 0			20				20			mA
With base-emitter junction reverse-biased	I_{CEV}	110 130 140 140	-1.5 0 -1.5 0				50						20	mA
At $T_C = 150^\circ\text{C}$		85 100 130	-1.5 -1.5 0				10						25	mA
At $T_C = 125^\circ\text{C}$		140	0				20							mA
Emitter Cutoff Current	I_{EBO}			-5 -6.5 -7	0 0 0		5 15				5			mA
DC Forward-Current Transfer Ratio	h_{FE}	2 2 2 5 5 5		5 ^a 8 ^a 10 ^a 2 ^a 10 ^a 12 ^a						20 150		12 100	100	
Magnitude of Small-Signal Forward-Current Transfer Ratio: $f = 5\text{ MHz}$ $f = 10\text{ MHz}$	$ h_{fe} $	10 10		2 1		12	12			8		12		
Collector-to-Emitter Sustaining Voltage With base open	$V_{CE0(sus)}$			0.2 ^b	0	90 ^b	75 ^b			120 ^b		100 ^b		V
With base-emitter junction reverse biased and external base-to-emitter resistance (R_{BE}) = 100 Ω	$V_{CEX(sus)}$		-1.5	0.2	0	150 ^b	120 ^b							V
With $R_{BE} < 50\Omega$ < 100 Ω	V_{CER}			0.2	0	110 ^b	95 ^b			130 ^b				V
Emitter-to-Base Voltage: $I_E = 0.05\text{ A}$ $I_E = 0.005\text{ A}$	V_{EBO}			0 0		7	7			6.5		7		V
Base-to-Emitter Voltage	V_{BE}	2 5 5		8 ^a 10 ^a 12 ^a			1.8	1.8					1.6	V
Collector-to-Emitter Saturation Voltage	$V_{CE(sat)}$			8 ^a 5 ^a 10 ^a 12 ^a 20 ^a	0.8 0.5 1.0 1.2 5				1.0		0.6 1		1.0	V
Base-to-Emitter Saturation Voltage	$V_{BE(sat)}$			6 ^a 8 ^a 10 ^a 20 ^a	0.5 0.8 1 5						1.3 2		2.0	V
Output Capacitance: $V_{CB} = 10\text{ V}$, $f = 1\text{ MHz}$	C_{ob}					400	400			400		400		pF
Forward-Bias Second Breakdown Collector Current: $t = 1\text{ s}$, nonrepetitive	$I_{S/b}$	25 28 45				5.0 0.9	5.0 0.9			5.5		5.0 0.9		A
Second-Breakdown Energy: With base reverse biased, $R_{BE} = 51\Omega$, $L = 25\mu\text{H}$ $R_B = 20\Omega$, $L = 180\mu\text{H}$	$E_{S/b}$			-1 -4 -4	5 13 8		13	13		0.3			5.7	mJ
Saturated Switching Time ($V_{CC} = 30\text{ V}$, $I_{B1} = I_{B2}$): Rise Time	t_r			5 8 10 12	0.5 0.8 1.0 1.2				0.5		1		0.5	μs
Storage Time	t_{s1}			5 8 10 12	0.5 0.8 1.0 1.2				1.5		1.5		1.5	μs
Storage Time (No Load)	t_{s2}			0.5	0.5						2			μs
Fall Time	t_f			5 8 10 12	0.5 0.8 1.0 1.2				0.5		0.2		0.5	μs
Thermal Resistance: Junction-to-Case	$R_{\theta JC}$	10 20		10 1			1.25	1.25			1.25		1.25	$^\circ\text{C/W}$

^a In accordance with JEDEC registration data format (JES-6, RDF-1).
^b Pulsed; pulse duration $\leq 350\mu\text{s}$, duty factor = 2%.
^c CAUTION: The sustaining voltages $V_{CE0(sus)}$, $V_{CER(sus)}$, and $V_{CEX(sus)}$ MUST NOT be measured on a curve tracer.

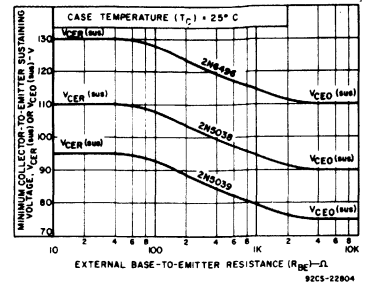


Fig. 4 - Collector-to-emitter sustaining voltage characteristics for 2N5038, 2N5039 and 2N6496.

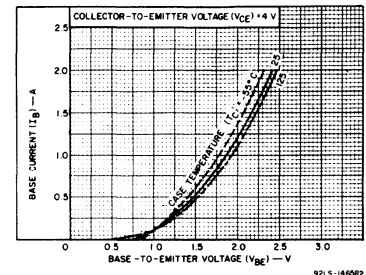


Fig. 5 - Typical input characteristics for 2N5038 and 2N5039.

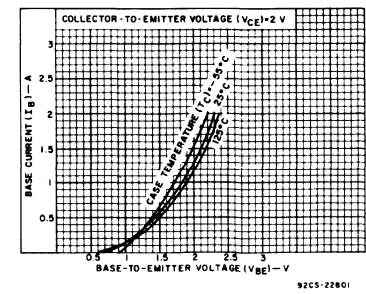


Fig. 6 - Typical input characteristic for 2N6496.

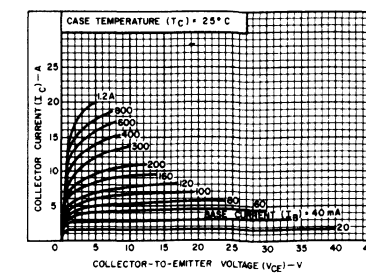


Fig. 7 - Typical output characteristics for 2N5038.

2N5038, 2N5039, 2N6354, 2N6496

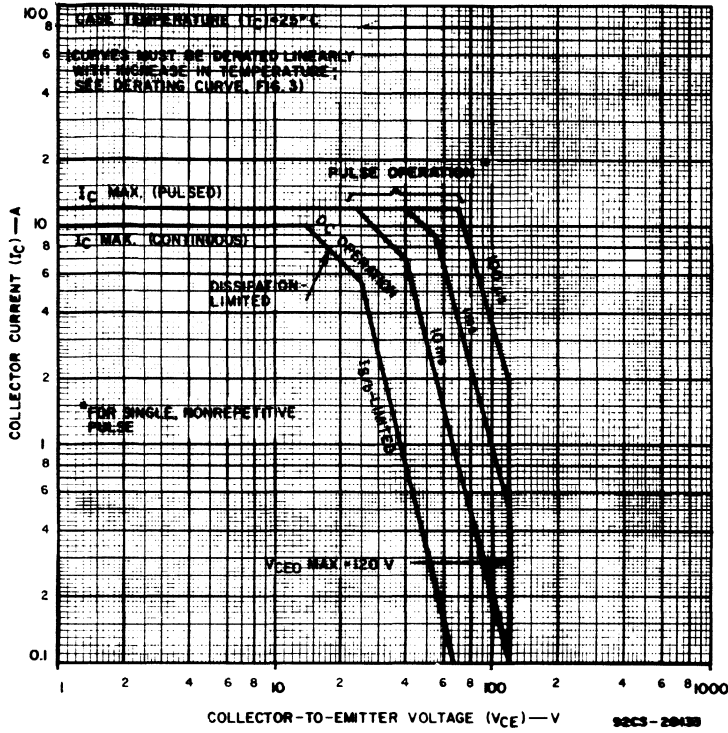


Fig. 8 - Maximum operating areas for 2N6354.

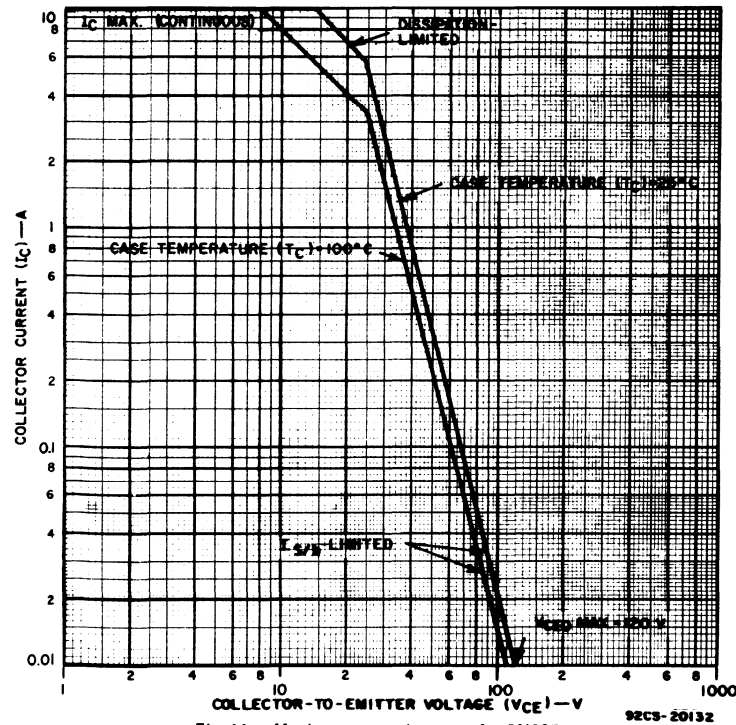


Fig. 11 - Maximum operating areas for 2N6354.

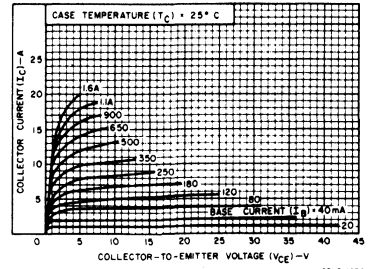


Fig. 9 - Typical output characteristics for 2N5039.

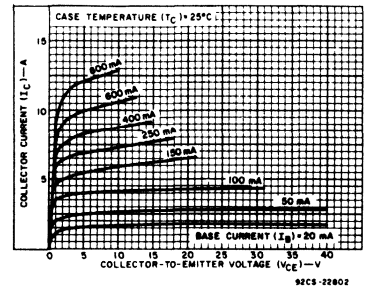


Fig. 10 - Typical output characteristics for 2N6496.

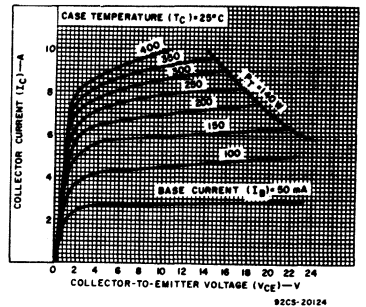


Fig. 12 - Typical output characteristics for 2N6354.

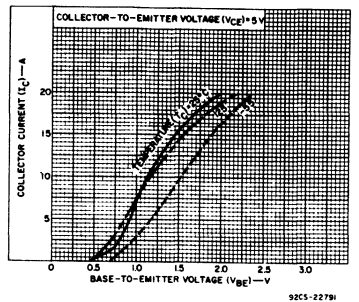


Fig. 13 - Typical transfer characteristics for 2N5038.

2N5038, 2N5039, 2N6354, 2N6496

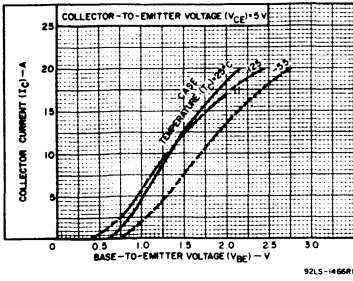


Fig. 14 - Typical transfer characteristics for 2N5039.

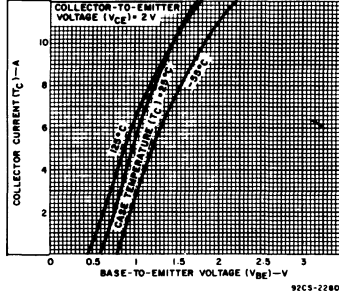


Fig. 15 - Typical transfer characteristics for 2N6496.

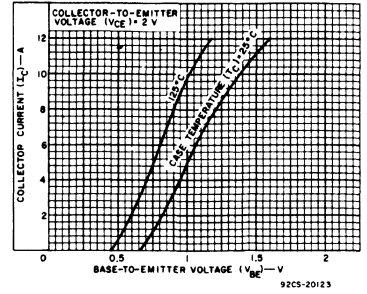


Fig. 16 - Typical transfer characteristics for 2N6354.

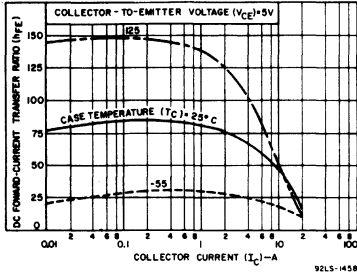


Fig. 17 - Typical dc beta characteristics for 2N5038.

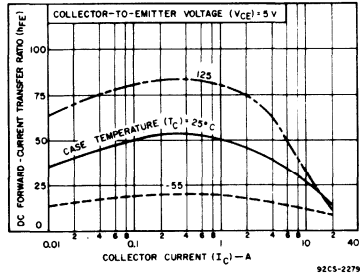


Fig. 18 - Typical dc beta characteristics for 2N5039.

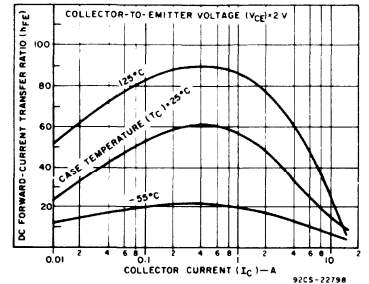


Fig. 19 - Typical dc beta characteristics for 2N6496.

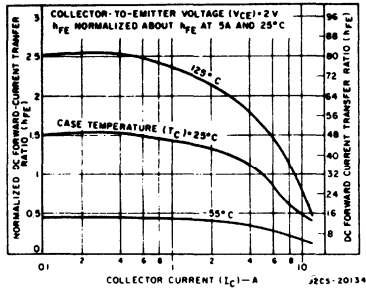


Fig. 20 - Typical normalized dc beta characteristics for 2N6354.

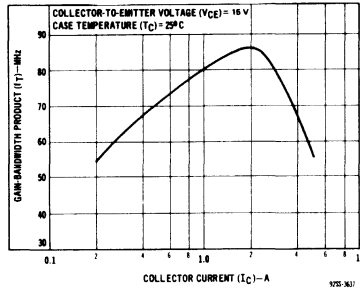


Fig. 21 - Typical gain-bandwidth product for 2N5038, 2N5039, 2N6496.

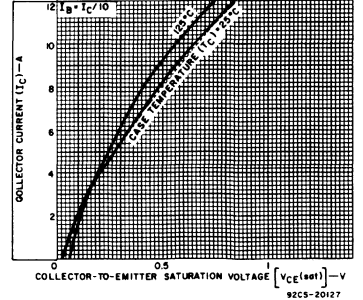


Fig. 22 - Typical saturation voltage characteristics for 2N6354.

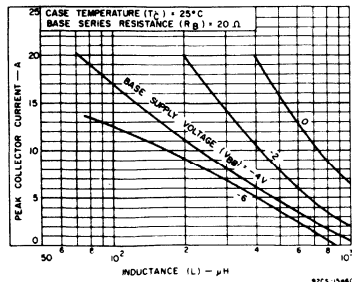


Fig. 23 - Maximum reverse-bias, second-breakdown characteristics for 2N5038 and 2N5039.

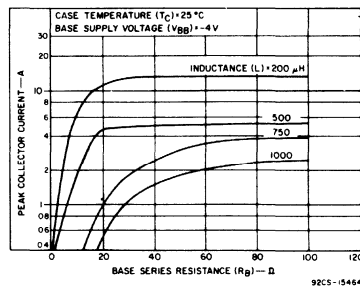


Fig. 24 - Maximum reverse-bias, second-breakdown characteristics for 2N5038 and 2N5039.

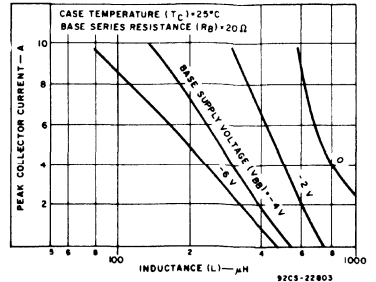


Fig. 25 - Maximum reverse-bias, second-breakdown characteristics for 2N6496.

2N5038, 2N5039, 2N6354, 2N6496

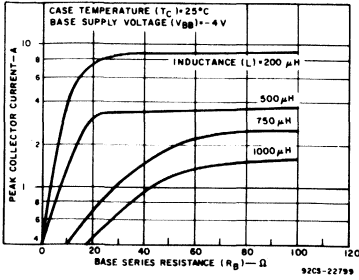


Fig. 26 - Maximum reverse-bias, second-breakdown characteristics for 2N6496.

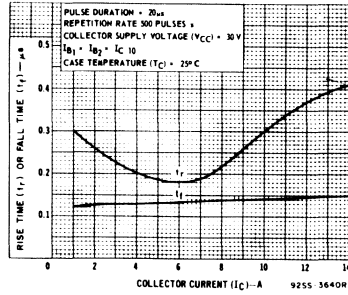


Fig. 27 - Typical rise-time and fall-time characteristics for 2N5038, 2N5039, 2N6496.

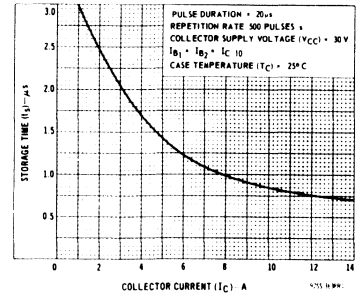


Fig. 28 - Typical storage time characteristics for 2N5038, 2N5039, 2N6496.

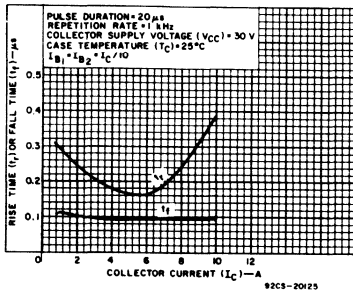


Fig. 29 - Typical rise- and fall-time characteristics for 2N6354.

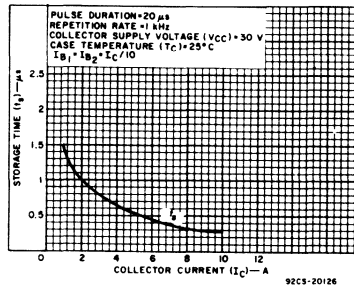


Fig. 30 - Typical storage-time characteristics for 2N6354.

2N5050, 2N5051, 2N5052

High-Voltage Silicon N-P-N Transistors

For High-Speed Switching and Linear-Amplifier Applications

The RCA-2N5050, 2N5051, and 2N5052 are silicon n-p-n transistors with high breakdown voltages and fast switching speeds.

Typical applications for these transistors include high-voltage operational amplifiers, high-voltage switches, switching regulators,

converters, inverters, deflection- and hi-fi amplifiers.

The 2N5050, 2N5051, and 2N5052 transistors are supplied in steel JEDEC TO-213MA hermetic packages.

Features:

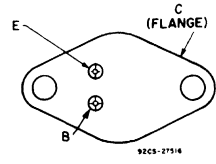
- Economy types for ac/dc circuits
- Fast turn-on time at high collector current

MAXIMUM RATINGS, Absolute-Maximum Values:

	2N5050	2N5051	2N5052	
* V_{CBO}	125	150	200	V
* V_{CEO}	125	150	200	V
* V_{EBO}	_____	6	_____	V
* I_C	_____	2	_____	A
* I_{CM}	_____	4	_____	A
* I_B	_____	1	_____	A
* P_T	_____	40	_____	W
T_C up to 25°C	_____	0.266	_____	W/°C
T_C above 25°C, derate linearly.	_____	_____	_____	°C
* T_{stg}	_____	-65 to 200	_____	°C
* T_C	_____	-65 to 175	_____	°C
* T_L	_____	_____	_____	°C
At distance $\geq 1/16$ in. (1.58 mm) from seating plane for 10 s max.	_____	235	_____	°C

* In accordance with JEDEC registration data.

TERMINAL DESIGNATIONS



JEDEC TO-213MA

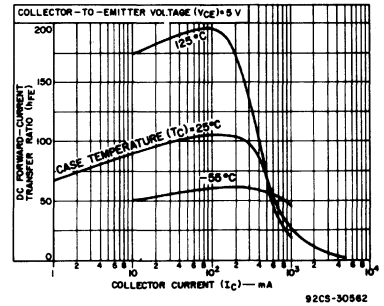


Fig. 2 - Typical dc beta characteristics for all types.

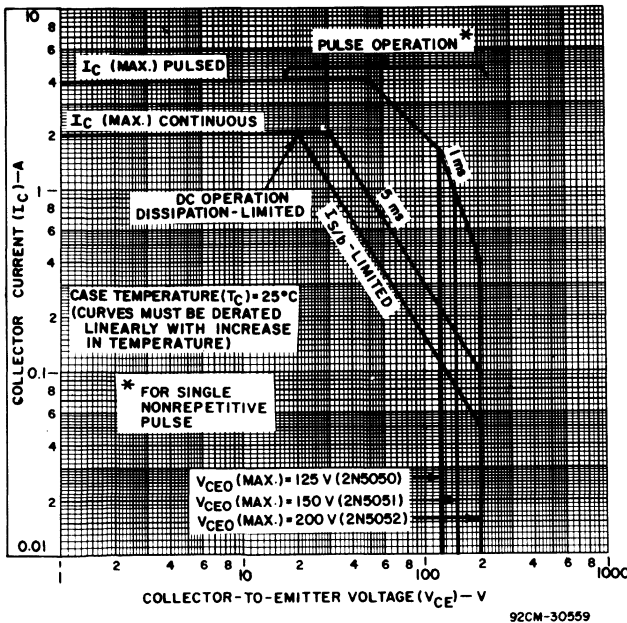


Fig. 1 - Maximum operating areas for all types.

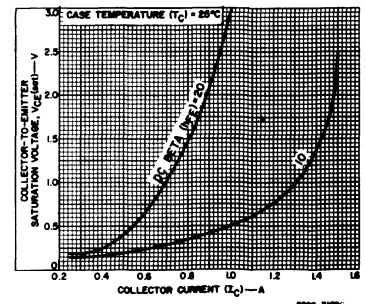


Fig. 3 - Typical collector-to-emitter saturation voltage as a function of collector current.

2N5050, 2N5051, 2N5052

ELECTRICAL CHARACTERISTICS, At Case Temperature (T_C) = 25°C
Unless Otherwise Specified

CHARACTERISTIC	TEST CONDITIONS				LIMITS						Units
	VOLTAGE V dc		CURRENT A dc		2N5050		2N5051		2N5052		
	V_{CE}	V_{BE}	I_C	I_B	Min.	Max.	Min.	Max.	Min.	Max.	
I_{CEX}	125	-1.5			-	0.5	-	-	-	-	mA
	150	-1.5			-	-	-	0.5	-	-	
	200	-1.5			-	-	-	-	-	0.5	
At $T_C = 150^\circ\text{C}$											
I_{CEO}	125	-1.5			-	5	-	-	-	-	mA
	150	-1.5			-	-	-	5	-	-	
	200	-1.5			-	-	-	-	-	5	
I_{CEO}	62.5				-	0.1	-	-	-	-	mA
	75				-	-	-	0.1	-	-	
	100				-	-	-	-	-	0.1	
I_{EBO}		-6	0		-	0.1	-	0.1	-	0.1	V
$V_{CEO(sus)}^b$			0.2 ^a	0	125	-	150	-	200	-	V
h_{FE}	5		0.75 ^a		25	100	25	100	25	100	-
	5		1 ^a		25	5	25	5	25	-	
	5		2 ^a		5	-	5	-	5	-	
V_{BE}	5		0.75 ^a		-	1.2	-	1.2	-	1.2	V
$V_{CE(sat)}$			0.75 ^a	0.1	-	1	-	1	-	1	V
			2 ^a	0.4	-	5	-	5	-	5	V
I_S/b	100				0.15	-	0.15	-	0.15	-	mA
$ h_{fe} $ f = 5 MHz	10		0.25		5	-	2	-	2	-	
h_{fe} f = 1 kHz	10		0.25		25	-	25	-	25	-	
C_{obo} f = 1 MHz	10 ^c		0		-	250	-	250	-	250	pF
t_r	120 ^d		0.75	0.1	-	0.3	-	0.3	-	0.3	μs
t_s	120 ^d		0.75	0.1	-	3.5	-	3.5	-	3.5	
t_f	120 ^d		0.75	0.1	-	1.2	-	1.2	-	1.2	
$R_{\theta JC}$					-	3.7	-	3.7	-	3.7	$^\circ\text{C/W}$

- ^a In accordance with JEDEC registration data.
- ^b Pulsed: pulse duration = 300 μs , duty factor $\leq 2\%$.
- ^c V_{CB} value
- ^d V_{CC} value
- CAUTION:** The sustaining voltage $V_{CEO(sus)}$ *MUST NOT* be measured on a curve tracer. See circuit, Fig. 9, or equivalent, to measure $V_{CEO(sus)}$.

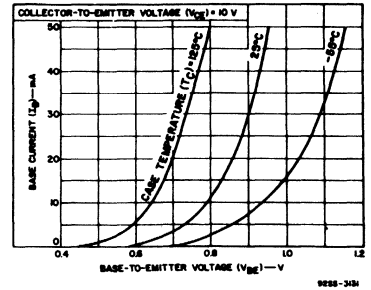


Fig. 4 - Typical input characteristics for all types.

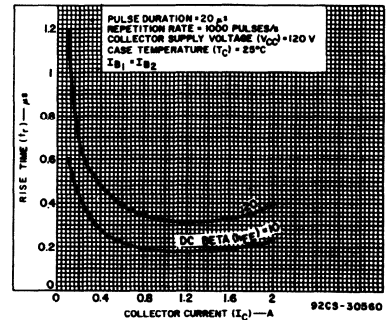


Fig. 5 - Typical rise time as a function of collector current.

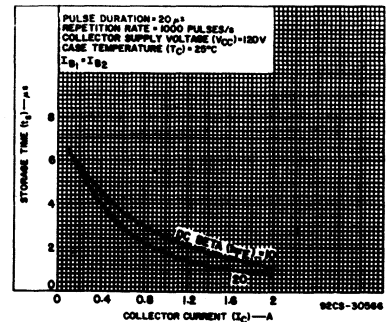


Fig. 6 - Typical storage time as a function of collector current.

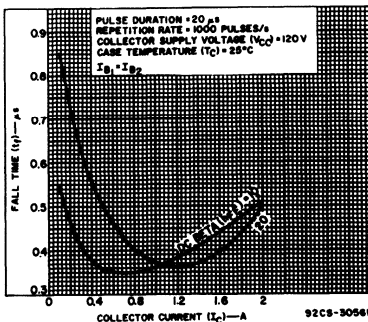


Fig. 7 - Typical fall time as a function of collector current.

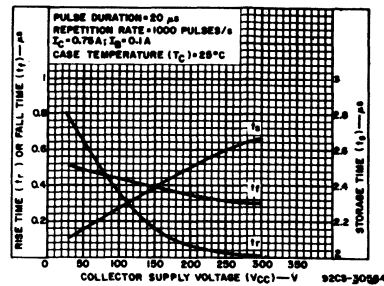


Fig. 8 - Typical rise, fall, and storage time as a function of collector supply voltage.

2N5239, 2N5240

High-Voltage Silicon N-P-N Transistors

For High-Speed Switching and Linear-Amplifier Applications in Industrial and Commercial Service

The RCA-2N5239 and 2N5240* are multiple epitaxial silicon n-p-n power transistors employing a new overlay construction with several emitter sites.

The high breakdown voltage ratings and exceptional second-breakdown capabilities of these transistors make them especially suitable for use in series regulators, power

amplifiers, inverters, deflection circuits, switching regulators, and high-voltage bridge amplifiers.

These types differ in breakdown voltage and leakage current values. The 2N5239 and 2N5240 are supplied in steel JEDEC TO-204MA hermetic packages.

*RCA Dev. Nos. TA2765 and TA2765A, respectively.

Features:

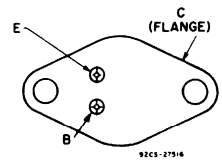
- High voltage ratings: $V_{CE}(sus) = 350\text{ V}, R_{BE} \leq 50\ \Omega$ (2N5240)
 $= 250\text{ V}, R_{BE} \leq 50\ \Omega$ (2N5239)
- High power dissipation rating:
 $P_T = 100\text{ W}$ at $V_{CE} = 150\text{ V}, T_C = 25^\circ\text{C}$
- For switching applications where circuit values and operating conditions require a transistor with a high second breakdown rating (IS/b) (limit line begins at 150 V)
- Exceptional second-breakdown: 0.67 A at $V_{CE} = 150\text{ V}$
- Maximum area-of-operation curves for dc and pulse operation

MAXIMUM RATINGS, Absolute-Maximum Values

	2N5239	2N5240	
* V_{CBO}	300	375	V
$V_{CE}(sus)$ $R_{BE} \leq 50\ \Omega$	250	350	V
* $V_{CEO}(sus)$	225	300	V
* V_{EBO}	_____	6	V
* I_C	_____	5	A
* I_B	_____	2	A
* P_T $T_C \leq 25^\circ\text{C}$ and $V_{CE} \leq 150\text{ V}$	_____	100	W
$T_C \leq 25^\circ\text{C}$ and $V_{CE} > 150\text{ V}$	_____	See Fig. 1	_____
$T_C > 25^\circ\text{C}$ and $V_{CE} > 150\text{ V}$	_____	See Fig. 1 and 2	_____
* T_{stg}, T_J	_____	- 65 to 100	$^\circ\text{C}$
T_L At distance $\geq 1/32$ in. (0.8 mm) from seating plane for 10 s max.....	_____	230	$^\circ\text{C}$

*In accordance with JEDEC registration data

TERMINAL DESIGNATIONS



JEDEC TO-204MA

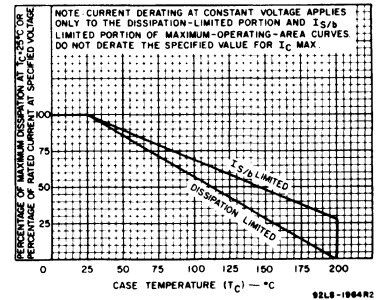


Fig. 1 - Derating curves for both types.

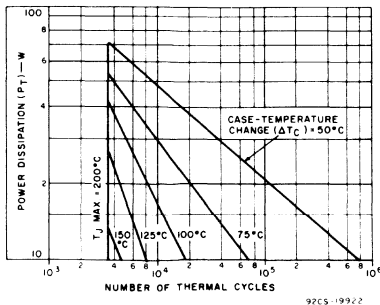


Fig. 2 - Thermal-cycling rating chart for both types.

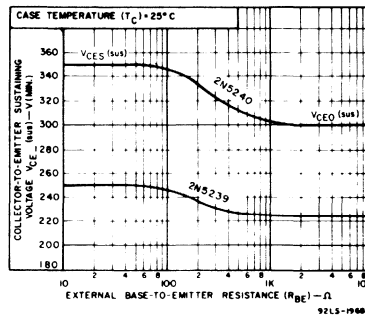


Fig. 3 - Sustaining voltages as a function of base-to-emitter resistance for both types.

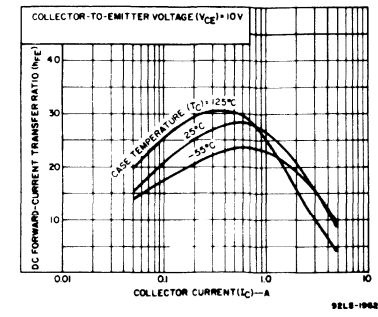


Fig. 4 - Typical dc beta characteristics for both types.

2N5239, 2N5240

ELECTRICAL CHARACTERISTICS, At Case Temperature (T_C) = 25°C unless otherwise specified

CHARACTERISTIC	TEST CONDITIONS				LIMITS				UNITS
	VOLTAGE V dc		CURRENT A dc		2N5239		2N5240		
	V _{CE}	V _{BE}	I _C	I _B	Min.	Max.	Min.	Max.	
* I _{CEO}	200			0	—	5	—	2	mA
* I _{CEV}	300 375	-1.5 -1.5			— —	4 —	— —	— 2	
(T _C = 150°C)	300	-1.5			—	5	—	3	
* I _{EBO} (V _{EB} = 5 V) (V _{EB} = 6 V)			0 0		— —	5 20	— —	1 20	V
V _{EBO}				0.02	6	—	6	—	
* V _{CEO(sus)} ^a			0.2 ^b		225	—	300	—	
* V _{CER(sus)} ^a (R _{BE} ≤ 50 Ω)			0.2 ^b		250	—	350	—	
* h _{FE}	10 10 10		0.4 ^b 2 ^b 4.5 ^b		20 20 5	80 80 —	20 20 5	80 80 —	V
* V _{BE}	10		2 ^b		—	3	—	3	
* V _{CE(sat)}			2 ^b 4.5 ^b	0.25 1.125	— —	2.5 5	— —	2.5 5	
* I _{S/b} (t = 1 s)	150				0.67	—	0.67	—	A
* ES/b (R _{BE} = 50 Ω, L = 0.2 mH, V _{EB} = 4 V)			4		1.6	—	1.6	—	mJ
* h _{fe} (f = 1 MHz)	10		0.2		2	—	2	—	
* h _{fe} (f = 1 kHz)	10		4		20	—	20	—	
f _T	10		0.2		2	—	2	—	MHz
C _{obo} (f = 1 MHz)	10 ^c		0		—	150	—	150	pF
R _{θJC}					—	1.75	—	1.75	°C/W

* In accordance with JEDEC registration data.

^a CAUTION: The sustaining voltages V_{CEO(sus)} and V_{CER(sus)} MUST NOT be measured on a curve tracer. These sustaining voltages should be measured by means of the test circuit shown in Fig. 14

^b Pulsed; pulse duration ≤ 350 μs, duty factor ≤ 2%.

^c V_{CB} value

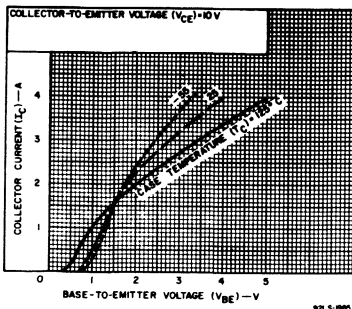


Fig. 5 - Typical transfer characteristics for both types.

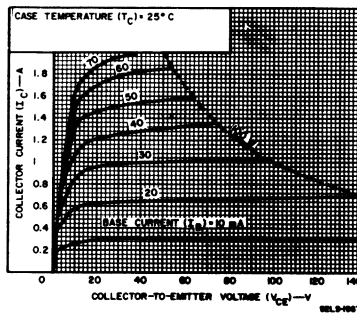


Fig. 6 - Typical output characteristics for both types.

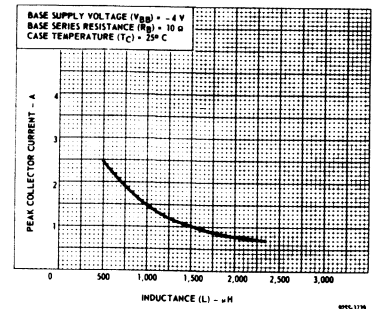


Fig. 7 - Typical reverse-bias, second-breakdown characteristic for both types.

2N5239, 2N5240

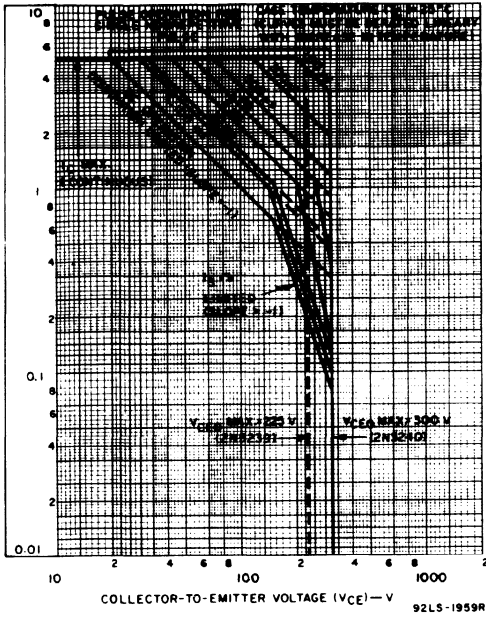


Fig. 8 - Maximum operating areas for both types.

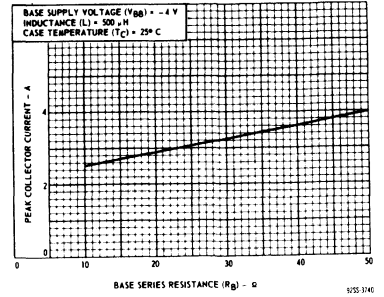


Fig. 9 - Typical reverse-bias, second-breakdown characteristic for both types.

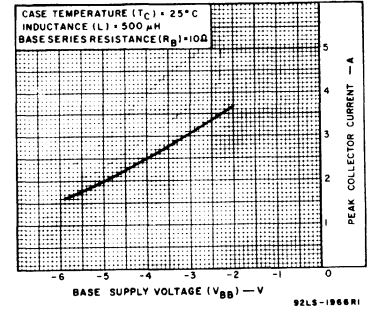


Fig. 10 - Typical reverse-bias, second-breakdown characteristic for both types.

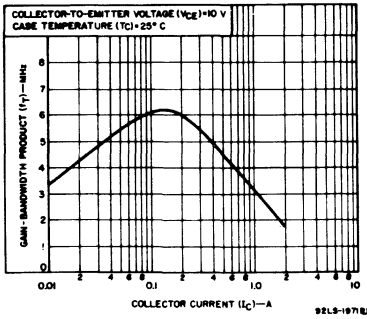


Fig. 11 - Typical gain-bandwidth product as a function of collector current for both types.

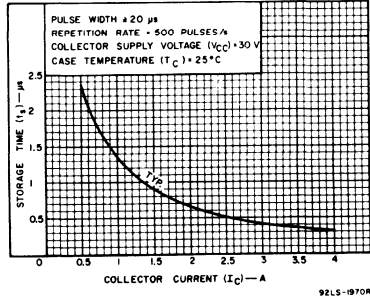


Fig. 12 - Typical saturated-switching time (storage) as a function of collector current for both types.

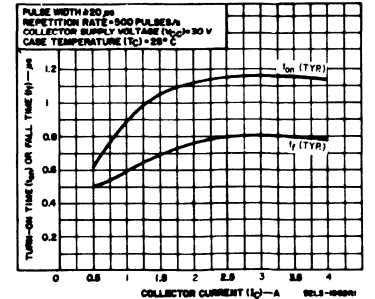


Fig. 13 - Typical saturated-time (turn-on or fall) as a function of collector current for both types.

Hometaxial-Base, Silicon N-P-N VERSAWATT Transistors

General-Purpose Types for Medium-Power Switching and Amplifier Applications in Military, Industrial, and Commercial Equipment

RCA-2N5293, 2N5294, 2N5295, 2N5296, 2N5297, 2N5298, and RCA3054 are hometaxial-base silicon n-p-n transistors. They are intended for a wide variety of medium-power switching and amplifier applications such as series and shunt regulators, and in driver and output stages of high-fidelity amplifiers. Types 2N5293, 2N5295, and 2N5297 have formed emitter and base leads for easy insertion

into TO-66 sockets. Types 2N5294, 2N5296, and 2N5298 are electrically identical to the 2N5293, 2N5295, and 2N5297, respectively, but have straight leads. The RCA3054 is supplied with straight leads.

These plastic power transistors differ in voltage ratings and in the currents at which the parameters are controlled.

2N5293-2N5298, RCA3054

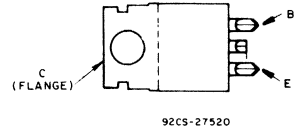
Features:

- Low saturation voltage—
 $V_{CE(sat)} = 1\text{ V max. at } I_C = 0.5\text{ A}$
 (2N5293, 2N5294)
 $= 1\text{ V max. at } I_C = 1\text{ A}$
 (2N5295, 2N5296)
 $= 1\text{ V max. at } I_C = 1.5\text{ A}$
 (2N5297, 2N5298)
- VERSAWATT package (molded-silicone plastic)
- Maximum safe-area-of-operation curves

MAXIMUM RATINGS, Absolute-Maximum Values:

	2N5293	2N5295	2N5297	2N5294	2N5296	2N5298	RCA3054					
COLLECTOR-TO-BASE VOLTAGE	VCBO							80	60	80	90	V
COLLECTOR-TO-EMITTER SUSTAINING VOLTAGE	VCEV(sus)							80	60	80	90	V
With -1.5 volts (VBE) of reverse bias	VCEV(sus)							75	50	70	60	V
With external base-to-emitter resistance (RBE) = 100 Ω	VCEV(sus)							70	40	60	55	V
With base open	VEBO							7	5	5	7	V
EMITTER-TO-BASE VOLTAGE	VEBO							7	5	5	7	V
COLLECTOR CURRENT	IC							4	4	4	4	A
BASE CURRENT	IB							2	2	2	2	A
TRANSISTOR DISSIPATION	PT											
At case temperatures up to 25°C								36	36	36	36	W
At case temperatures above 25°C								Derate linearly at 0.288				W/°C
At ambient temperatures up to 25°C								18	18	18	18	W
At ambient temperatures above 25°C								Derate linearly at 0.0144				W/°C
TEMPERATURE RANGE								— 65 to +150 —				°C
Storage and Operating (Junction)								— 235 —				°C
LEAD TEMPERATURE (During soldering)												
At distance ≥ 1/8 in. (3.17 mm) from case for 10 s max												

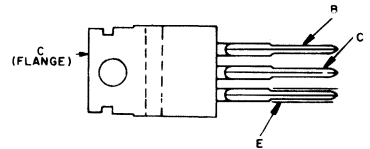
TERMINAL DESIGNATIONS



92CS-27520

BOTTOM VIEW

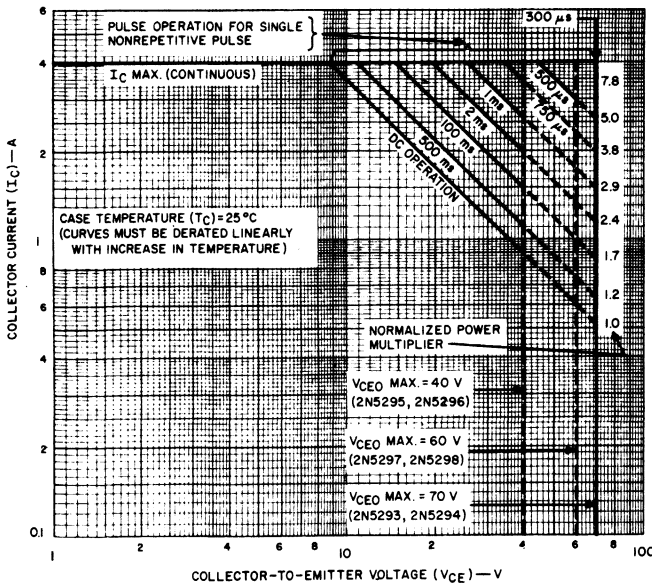
JEDEC TO-220AA
2N5293, 2N5295, 2N5297



92CS-27519

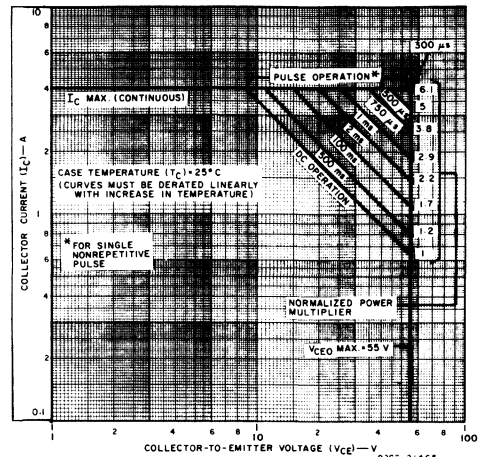
BOTTOM VIEW

JEDEC TO-220AB
2N5294, 2N5296, 2N5298, RCA3054



92CS-17160R1

Fig. 1 — Maximum operating areas for 2N5293-2N5298.



92CS-21465

Fig. 2 — Maximum operating areas for RCA3054.

2N5293-2N5298, RCA3054

ELECTRICAL CHARACTERISTICS, At Case Temperature (T_C) = 25°C, unless otherwise specified.

CHARACTERISTIC SYMBOL	TEST CONDITIONS				LIMITS								UNITS
	VOLTAGE V dc		CURRENT A dc		2N5293 2N5294		2N5295 2N5296		2N5297 2N5298		RCA3054		
	V _{CE}	V _{BE}	I _C	I _B	MIN.	MAX.	MIN.	MAX.	MIN.	MAX.	MIN.	MAX.	
I _{CEV} [•]	90	-1.5			-	-	-	-	-	-	-	1	mA
	65	-1.5			-	0.5	-	-	-	0.5	-	-	
	35	-1.5			-	-	-	2	-	-	-	-	
I _{CEV} [•] (T _C = 150°C)	90	-1.5			-	-	-	-	-	-	-	6	
	65	-1.5			-	3	-	-	-	3	-	-	
	35	-1.5			-	-	-	5	-	-	-	-	
I _{CER} (R _{BE} = 100 Ω)	50				-	0.5	-	-	-	0.5	-	-	mA
	20				-	-	-	-	-	-	-	-	
I _{CER} (T _C = 150°C)	50				-	2	-	-	-	2	-	-	mA
I _{EBO}		-7	0		-	1	-	-	-	-	-	1	mA
		-5	0		-	-	-	1	-	1	-	-	
		-4	0		-	-	-	-	-	-	-	-	
h _{FE} ^c	4		0.5		30	120	-	-	-	-	25	100	
	4		1		-	-	30	120	-	-	-	-	
	4		1.5		-	-	-	-	20	80	-	-	
V _{CEO(sus)} ^c			0.1	0	70	-	-	-	-	-	55	-	V
			0.1	0	-	-	40	-	-	-	-	-	
			0.1	0	-	-	-	-	60	-	-	-	
V _{CER(sus)} ^c (R _{BE} = 100 Ω)			0.1		75	-	-	-	-	-	-	-	V
			0.1		-	-	50	-	-	-	-	-	
			0.1		-	-	-	-	70	-	60	-	
V _{CEV(sus)} ^c		-1.5	0.1		80	-	-	-	-	-	-	-	V
		-1.5	0.1		-	-	60	-	-	-	-	-	
		-1.5	0.1		-	-	-	-	80	-	90	-	
V _{BE} ^c	4		0.5		-	1.1	-	-	-	-	-	1.7	V
	4		1		-	-	-	1.3	-	-	-	-	
	4		1.5		-	-	-	-	-	1.5	-	-	
V _{CE(sat)} ^c			0.5	0.05	-	1	-	-	-	-	-	1	V
			1	0.05	-	-	-	-	-	-	-	-	
			1	0.1	-	-	-	1	-	-	-	-	
			1.5	0.15	-	-	-	-	-	1	-	-	
f _T	4		0.2		0.8	-	0.8	-	0.8	-	0.8	-	MHz
t _{ON}	V _{CC} = 30		0.5	0.05 ^a	-	5	-	-	-	-	-	-	μs
			1	0.1 ^a	-	-	-	5	-	-	-	-	
			1.5	0.15 ^a	-	-	-	-	-	5	-	-	
t _{OFF}	V _{CC} = 30		0.5	-0.5 ^a	-	15	-	-	-	-	-	-	μs
			1	-0.1 ^b	-	-	-	15	-	-	-	-	
			1.5	-0.15 ^b	-	-	-	-	-	15	-	-	
R _{θJC}					-	3.5	-	3.5	-	3.5	-	3.5	°C/W
R _{θJA}					-	70	-	70	-	70	-	70	°C/W

^a I_{B1} value (turn-on base current).

^b I_{B2} value (turn-off base current).

^c Pulsed, pulse duration = 300 μs, duty factor = .018.

[•] I_{CEX} for RCA3054.

2N5293-2N5298, RCA3054

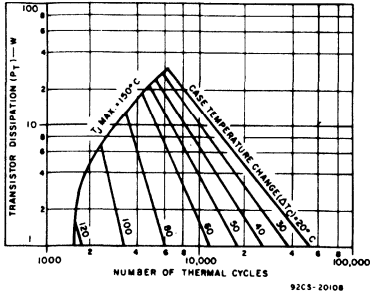


Fig. 3 - Thermal-cycling rating chart for all types.

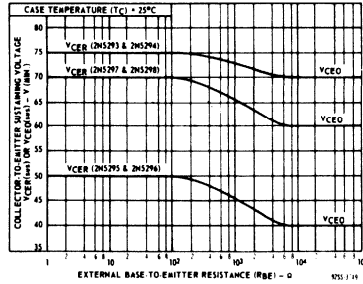


Fig. 4 - Sustaining voltage vs. base-to-emitter resistance for 2N5293-2N5298.

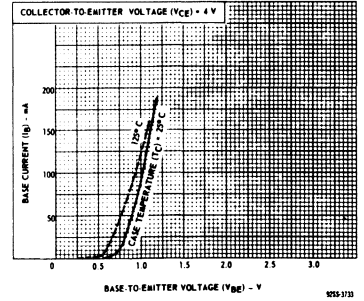


Fig. 5 - Typical input characteristics for 2N5293, 2N5294, and RCA3054.

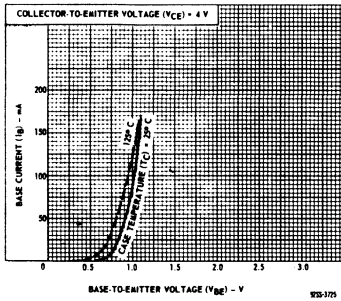


Fig. 6 - Typical input characteristics for 2N5295 and 2N5296.

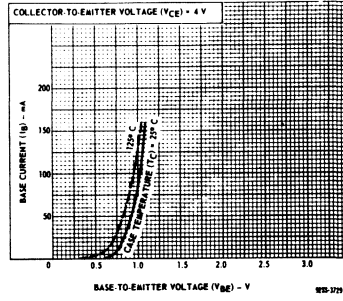


Fig. 7 - Typical input characteristics for types 2N5297 and 2N5298.

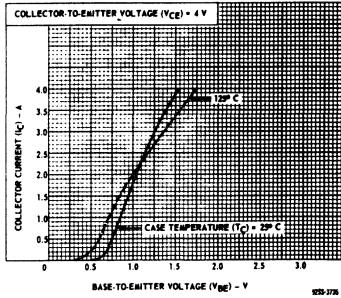


Fig. 8 - Typical transfer characteristics for 2N5293, 2N5294, and RCA3054.

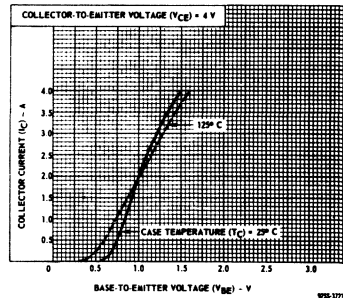


Fig. 9 - Typical transfer characteristics for 2N5295 and 2N5296.

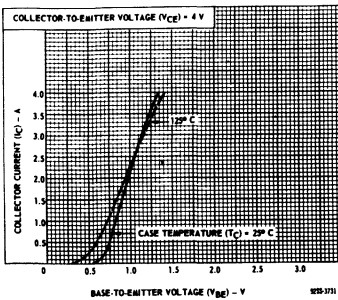


Fig. 10 - Typical transfer characteristics for 2N5297 and 2N5298.

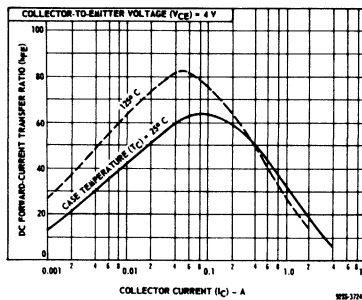


Fig. 11 - Typical dc beta for 2N5293, 2N5294, and RCA3054.

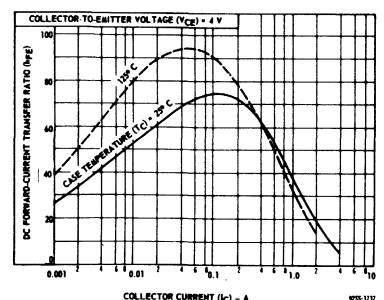


Fig. 12 - Typical dc beta for 2N5295, 2N5296, and 2N5298.

2N5293-2N5298, RCA3054

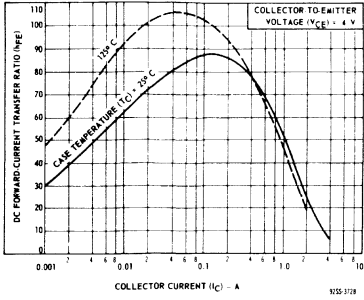


Fig. 13—Typical dc beta for 2N5297 and 2N5298.

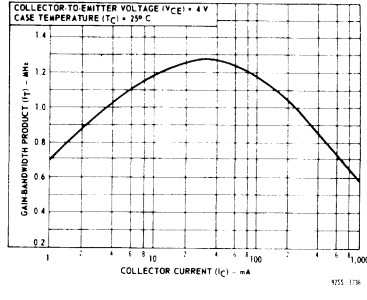


Fig. 14—Typical gain-bandwidth product for 2N5293, 2N5294, and RCA3054.

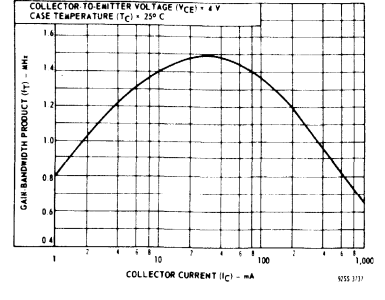


Fig. 15—Typical gain-bandwidth product for 2N5295 and 2N5296.

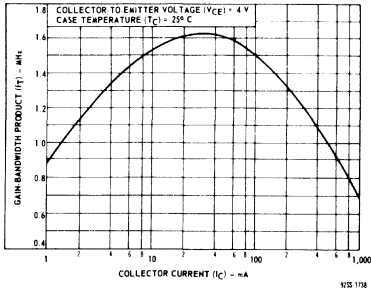


Fig. 16—Typical gain-bandwidth product for 2N5297 and 2N5298.

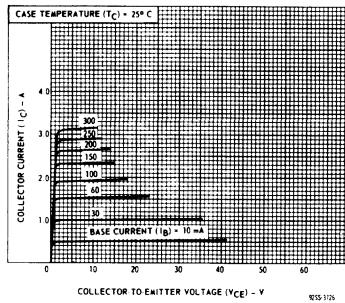


Fig. 17—Typical output characteristics for 2N5293, 2N5294, and RCA3054.

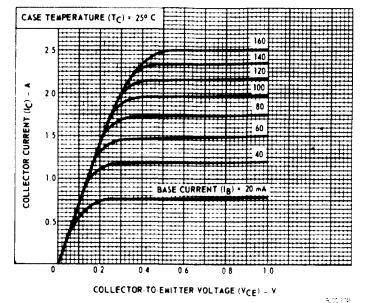


Fig. 18—Typical output characteristics for 2N5295 and 2N5296.

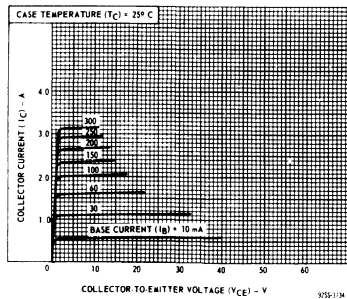


Fig. 19—Typical output characteristics for 2N5295 and 2N5296.

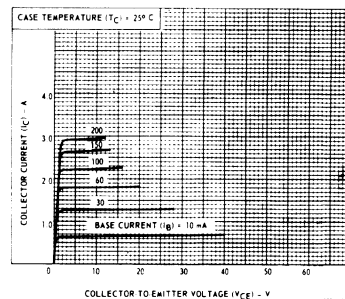


Fig. 20—Typical output characteristics for 2N5297 and 2N5298.

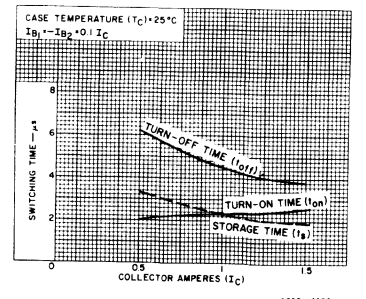


Fig. 21—Typical saturated switching characteristics for 2N5295, 2N5296, and RCA3054.

2N5301, 2N5302, 2N5303

High-Current High-Power High-Speed N-P-N Power Transistors

The RCA-2N5301, 2N5302 and 2N5303 are epitaxial-base silicon n-p-n transistors intended for a wide variety of high-power, high-current applications, such as power-switching circuits, driver and output stages for series and shunt regulators, dc-to-dc

converters, inverters, and solenoid (hammer) /relay drivers.

These devices differ in maximum voltage ratings and $V_{CE(sat)}$, $V_{BE(sat)}$, and V_{BE} characteristics. All are supplied in JEDEC TO-204MA hermetic steel packages.

Features:

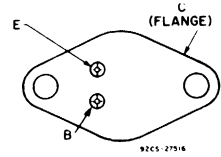
- Specification for h_{FE} and $V_{CE(sat)}$ up to 30A
- Current gain-bandwidth product $f_T = 2$ MHz min. at 1A
- Low saturation voltage with high beta
- High dissipation capability

MAXIMUM RATINGS, Absolute-Maximum Values:

	2N5301	2N5302	2N5303	
* V_{CBO}	40	60	80	V
* $V_{CEO(sus)}$	40	60	80	V
* V_{EBO}	5	5	5	V
* I_C	30	30	30	A
* I_{CM}	50	50	50	A
* I_B	7.5	7.5	7.5	A
* I_{BM}	15	15	15	A
* P_T				W
At $T_C \leq 25^\circ C$	200	200	200	
At $T_C > 25^\circ C$	Derate linearly			$W/^\circ C$
See Fig. 1 and 2				
* T_{stg}, T_J	-65 to 200	-65 to 200	-65 to 200	$^\circ C$
* T_L				$^\circ C$
At distance $\geq 1/32$ in. (0.8 mm) from seating plane for 10 s max.	230	230	230	

* In accordance with JEDEC registration data format JS-6 RDF-2.

TERMINAL DESIGNATIONS



JEDEC TO-204MA

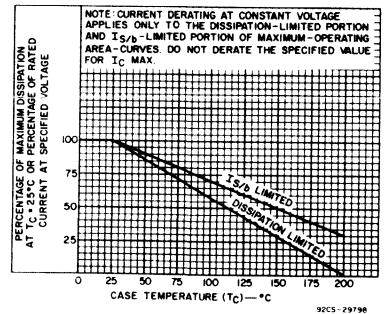


Fig. 2 — Derating curves for 2N5301, 2N5302, and 2N5303.

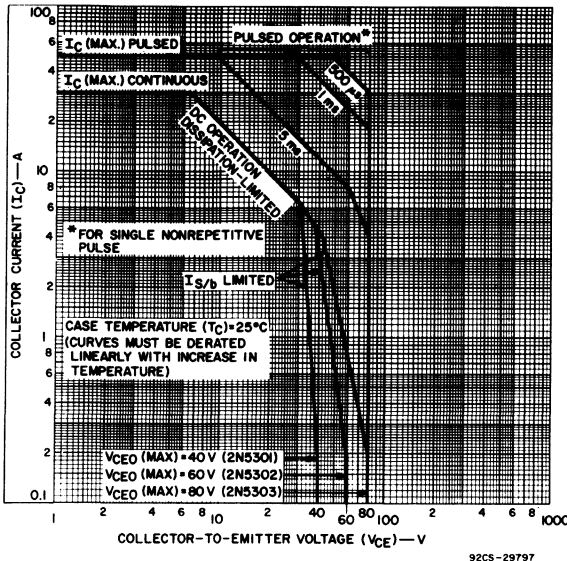


Fig. 1 — Maximum operating areas for 2N5301, 2N5302, and 2N5303.

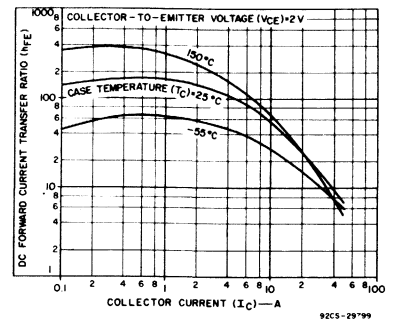


Fig. 3 — Typical dc beta characteristics as a function of collector current for 2N5301, 2N5302, and 2N5303.

2N5301, 2N5302, 2N5303

ELECTRICAL CHARACTERISTICS, at Case Temperature (T_C) = 25°C unless otherwise specified

CHARACTERISTIC	TEST CONDITIONS				LIMITS						UNITS	
	VOLTAGE V dc		CURRENT A dc		2N5301		2N5302		2N5303			
	V _{CE}	V _{BE}	I _C	I _B	Min.	Max.	Min.	Max.	Min.	Max.		
* I _{CBO}	40 ^a 60 ^a 80 ^a				-	1	-	-	1	-	-	mA
* I _{CEX}	40 60 80	-1.5 -1.5 -1.5			-	1	-	-	1	-	-	
* I _{CEX} T _C = 150°C	40 60 80	-1.5 -1.5 -1.5			-	10	-	-	10	-	-	
* I _{CEO}	40 60 80				-	5	-	-	5	-	-	
* I _{EBO}		-5			-	5	-	-	5	-	5	
* h _{FE}	2 2 3 2 3		1 ^b 10 ^b 15 ^b 20 ^b 30 ^b		40 - 15 - 5	- - 60 - -	40 - 15 - 5	- - 60 - -	40 15 - 5 -	- - - - -	60 - - - -	V
* V _{CEO(sus)}			0.2		40	-	60	-	80	-		
* V _{BE}	2 2 4 4		10 ^b 15 ^b 20 ^b 30 ^b		- - - -	- 1.7 - 3	- - - -	- 1.7 - 3	- - - -	1.5 - 2.5 -		
* V _{BE(sat)}			10 ^b 15 ^b 20 ^b 20 ^b	1 1.5 2 4	- - - -	1.7 1.8 2.5 -	- - - -	1.7 1.8 2.5 -	- - - -	1.7 2 - 2.5		
* V _{CE(sat)}			10 ^b 15 ^b 20 ^b 20 ^b 30 ^b	1 1.5 2 4 6	- - - - -	0.75 - 2 - 3	- - - - -	0.75 - 2 - 3	- - - - -	1 1.5 - - 2		
I _{S/b} t _p = 1 s nonrep.	20				10	-	10	-	10	-	A	
E _{S/b} L = 125 μH, R _{BE} = 51 Ω		-1.5	10	-	6.25	-	6.25	-	6.25	-	mJ	
* h _{fe} f = 1 MHz	10		1	-	2	-	2	-	2	-		
* h _{fe} f = 1 kHz	10		1	-	40	-	40	-	40	-		
* t _r (See Fig.8)	V _{CC} =		10	1	-	1	-	1	-	1	μs	
* t _s	30		10	1 ^c	-	2	-	2	-	2		
* t _f			10	1 ^c	-	1	-	1	-	1		
R _{θJC}	20		5	-	-	0.875	-	0.875	-	0.875	°C/W	

* In accordance with JEDEC registration data format JS-6 RDF-1.

^a V_{CB}

^b Pulsed; pulse duration = 300 μs, duty factor = 1.8%

^c I_{B1} = -I_{B2}

2N5301, 2N5302, 2N5303

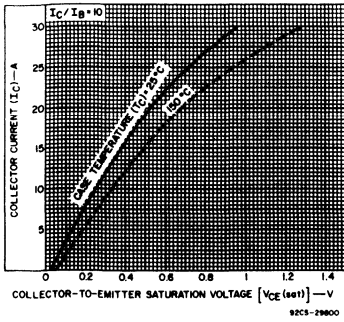


Fig. 4 - Typical saturation voltage characteristics for 2N5301, 2N5302, and 2N5303.

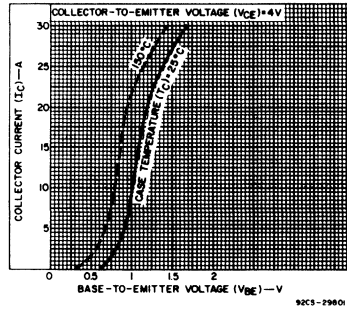


Fig. 5 - Typical transfer characteristics for 2N5301, 2N5302, and 2N5303.

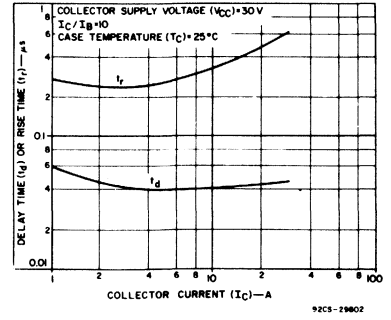


Fig. 6 - Typical delay-time and rise-time characteristics as a function of collector current for 2N5301, 2N5302, and 2N5303.

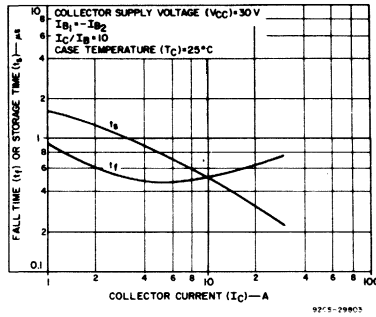


Fig. 7 - Typical storage-time and fall-time characteristics as a function of collector current for 2N5301, 2N5302, and 2N5303.

2N5320-2N5323

Complementary N-P-N & P-N-P Silicon Power Transistors

General-Purpose Types for Small-Signal, Medium-Power Applications

RCA-2N5320, 2N5321, 2N5322 and 2N5323 are double-diffused epitaxial-planar silicon power transistors intended for small-signal medium-power applications. The 2N5320 and 2N5321 n-p-n types are actually high-current, high-dissipation versions of the 2N2102 with all of the salient features of that device. The 2N5322 and 2N5323, p-n-p complements of the 2N5320 and 2N5321, are actually high-current, high-power

versions of the 2N4036 with all of its additional outstanding features. (Technical data on the 2N2102 and 2N4036 are shown on pages 29 and 71, respectively).

The devices are supplied in the JEDEC TO-39 hermetic package.

Features:

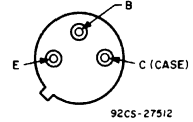
- 2N5322 } P-N-P { 2N5320
- 2N5323 } Complements of: { 2N5321
- Maximum safe-area-of-operation curves
- Planar construction for low-noise and low-leakage characteristics
- Low saturation voltage
- High beta at high collector current

MAXIMUM RATINGS, Absolute Maximum Values

	2N5321	2N5323	2N5320	2N5322	
COLLECTOR-TO-BASE VOLTAGE	75	75	100	100	V
COLLECTOR-TO-EMITTER SUSTAINING VOLTAGE:					
With 1.5 volts (V _{BE}) of reverse bias	75	75	100	100	V
With external base-to-emitter resistance (R _{BE}) = 100 Ω	65	65	90	90	V
With base open	50	50	75	75	V
EMITTER-TO-BASE VOLTAGE	5	5	7	7	V
COLLECTOR CURRENT	2	2	2	2	A
BASE CURRENT	1	1	1	1	A
TRANSISTOR DISSIPATION	10	10	10	10	W
At case temperatures up to 25° C					
At case temperatures above 25° C					Derate linearly at 0.057 W/°C
TEMPERATURE RANGE:					
Storage and operating (Junction)	← 65 to + 200 →				°C
LEAD TEMPERATURE (During soldering):					
At distance ≥ 1/32 in. (0.8 mm) from seating plane for 10 s max	← 230 →				°C

* In accordance with JEDEC registration data format (JS-6-RDF-1)
 • For p-n-p devices, voltage and current values are negative.

TERMINAL DESIGNATIONS



JEDEC TO-39

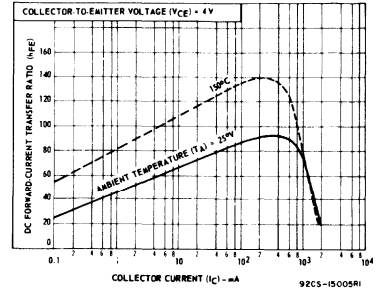


Fig. 1 - Typical static beta characteristics for types 2N5320 and 2N5321.

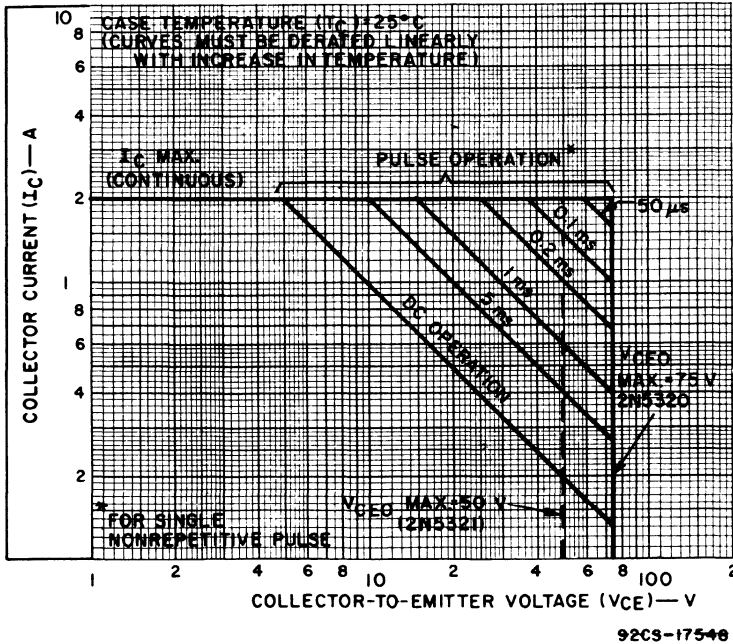


Fig. 2 - Maximum operating areas for 2N5320 and 2N5321.

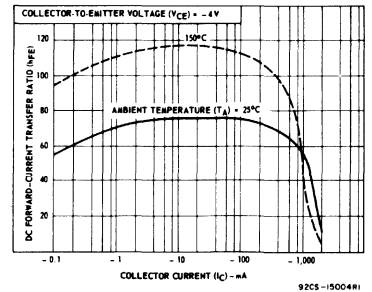


Fig. 3 - Typical static beta characteristics for 2N5322 and 2N5223.

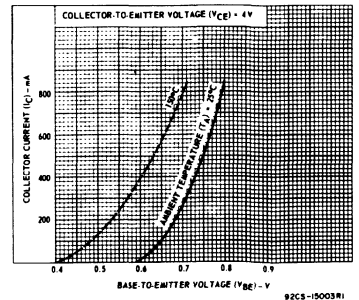


Fig. 4 - Typical transfer characteristics for 2N5320 and 2N5321.

2N5320-2N5323

ELECTRICAL CHARACTERISTICS, Case Temperature (T_C) = 25°C Unless Otherwise Specified

CHARACTERISTIC	Symbol	TEST CONDITIONS						LIMITS								Units
		DC Voltage V			DC Current mA			Type 2N5320		Type 2N5321		Type 2N5322		Type 2N5323		
		V _{CB}	V _{CE}	V _{BE}	I _C	I _B	Min	Max	Min	Max	Min	Max	Min	Max		
Collector-Cutoff Current: With base open (I _E = 0)	I _{CBO}	80 60 80 60						0.5	-	5	-	-	0.5	-	-	μA
With base-emitter junction reverse biased	I _{CEX}	100 75 -100 -75	-1.5 -1.5 1.5 1.5					0.1	-	0.1	-	-	-0.1	-	-	mA
T _C = 150°C	I _{CEX}	70 45 70 -45	-1.5 -1.5 1.5 1.5					5	-	5	-	-	-5	-	-	mA
Emitter-Cutoff Current	I _{EBO}			-7 -5 7 5	0 0 0 0			0.1	-	0.1	-	-	-0.1	-	-	mA
				-5 -4 5 4	0 0 0 0			0.1	-	0.5	-	-	-0.1	-	-0.5	μA
Collector-to-Emitter Breakdown Voltage With base-emitter junction reverse biased	(I _B)/V _{CEV}			-1.5 1.5	0.1 0.1	100		75	-	-	-	100	-	-	75	V
Collector-to-Emitter Sustaining Voltage With external base to emitter resistance R _{BE} = 100 Ω	V _{CE(sus)} ^a				100 100	90		65	-	-	-	90	-	-	65	V
With base open	V _{CE0(sus)} ^a				100 100	0 0	75		50	-	-	75	-	-	-	V
Collector to Emitter Saturation Voltage	V _{CE(sat)}				500 -500	50 50		0.5		0.8			0.7		-1.2	V
Base-to-Emitter Voltage	V _{BE}			4 -4	500 -500			1.1		1.4			-1.1		-1.4	V
DC Forward Current Transfer Ratio	h _{FE} ^b See NOTE			4 -4 2 -2	500 500 1000 -1000		30	130	40	250		30	130	40	250	
Gain-Bandwidth Product	f _T			4 -4	50 50		50		50			50		50		MHz
Magnitude of common-emitter, small-signal, short circuit, forward current transfer ratio (f = 10 MHz)	h _{fe}			4 -4	50 -50		5		5			5		5		
Second Breakdown Collector Current ^c (With base forward biased)	I _{S/B}			50 -35			200		200			-285		285		mA
Sat. Switching Time:																
Turn-on Time	t _{on}			30 -30	500 -500	50 -50		80		80			100		100	ns
Turn-off Time	t _{off}			30 -30	500 -500	50 -50		800		800			1000		1000	ns
Thermal Resistance: Junction-to-Case	R _{θJC}							17.5		17.5			17.5		17.5	°C/W
Junction-to-Ambient	R _{θJA}							150		150			150		150	°C/W

* In accordance with JEDEC registration data format (JS-6-RDF-1)
 For p-n-p devices, voltage and current values are negative.
^a CAUTION: The sustaining voltages V_{CE0(sus)} and V_{CE(sus)} MUST NOT be measured on a curve tracer.
^b Pulsed; pulse duration < 300 μs, duty factor < 0.02.
^c Pulsed; 0.4s non-repetitive pulse.
^d I_{S/B} is defined as the current at which second breakdown occurs at junction forward-biased for transistor operation in the active region.

2N5320-2N5323

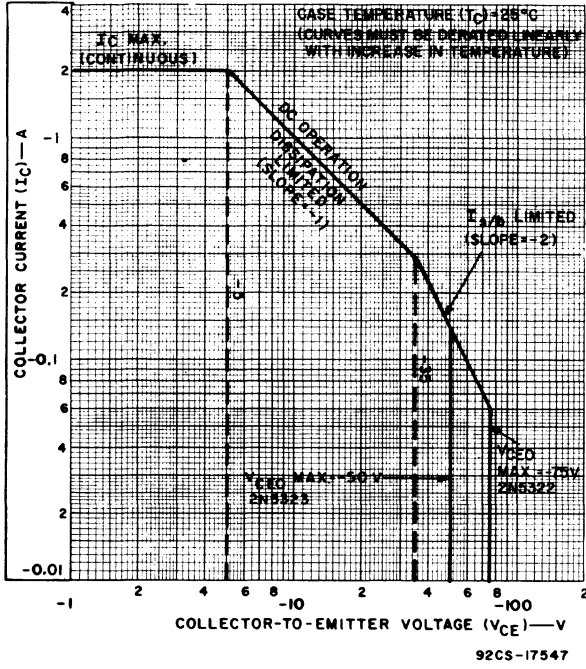


Fig. 5 – Maximum operating areas for 2N5322 and 2N5323.

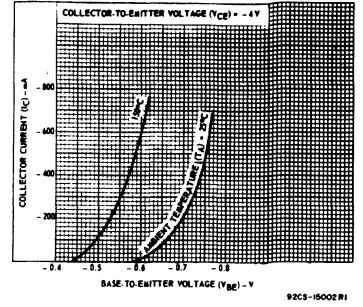


Fig. 6 – Typical transfer characteristics for 2N5322 and 2N5323.

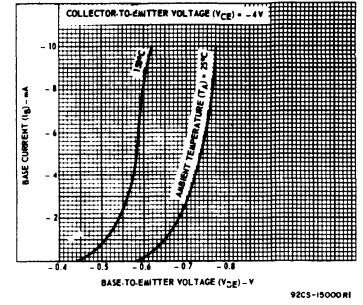


Fig. 7 – Typical input characteristics for 2N5322 and 2N5323.

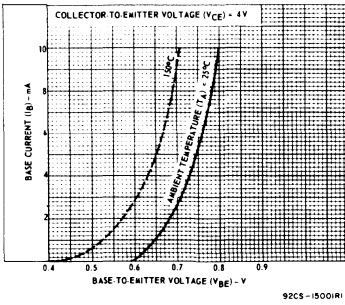


Fig. 8 – Typical input characteristics for 2N5320 and 2N5321.

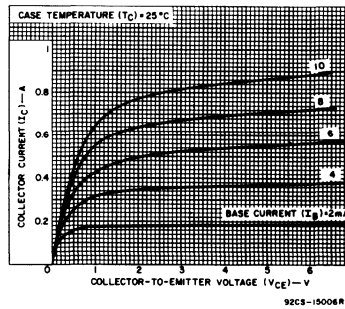


Fig. 9 – Typical output characteristics for 2N5320 and 2N5321.

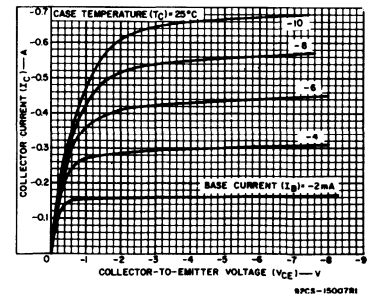


Fig. 10 – Typical output characteristics for 2N5322 and 2N5323.

2N5415, 2N5416, RCS880-RCS882

Silicon P-N-P High-Voltage Transistors

For High-Speed Switching and Linear-Amplifier Applications in Military, Industrial and Commercial Equipment

The RCA-2N5415, 2N5416 and RCS880, RCS881, and RCS882 are silicon p-n-p transistors with high breakdown voltages, high frequency response, and fast switching speeds. All of these types are supplied in the JEDEC TO-39 hermetic package.

These transistors differ primarily in their voltage ratings. Typical applications include high-voltage differential and operational amplifiers; high-voltage inverters; and high-voltage, low-current switching and series regulators.

Features:

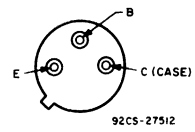
- 2N5415: p-n-p complement of 2N3440
- 2N5415: p-n-p complement of 2N3439
- Maximum safe-area-of-operation curves
- High voltage ratings:
 $V_{CBO} = -350$ V max. (2N5416)
 $V_{CEO(sus)} = -300$ V max. (2N5416, RCS882)
 -250 V max. (RCS881)
 -200 V max. (2N5415)
 -150 V max. (RCS880)

MAXIMUM RATINGS, Absolute-Maximum Values:

	2N5415	2N5416	RCS880	RCS881	RCS882		
*COLLECTOR-TO-BASE VOLTAGE	V_{CBO}	-200	-350	-	-250	-350	V
COLLECTOR-TO-EMITTER SUSTAINING VOLTAGE:							
With external base-to-emitter resistance (R_{BE}) = 50 Ω	$V_{CER(sus)}$	-	-350	-	-	-350	V
* With base open	$V_{CEO(sus)}$	-200	-300	-150	-250	-300	V
*EMITTER-TO-BASE VOLTAGE	V_{EBO}	-4	-6	-	-4	-6	V
*COLLECTOR CURRENT	I_C	-1	-1	-1	1	-1	A
*BASE CURRENT	I_B	-0.5	-0.5	-0.5	-0.5	-0.5	A
*TRANSISTOR DISSIPATION:	P_T						
At case temperatures up to 25°C		10	10	7.5	7.5	7.5	W
At case temperatures above 25°C		Derate linearly to 200°C					
At ambient temperatures up to 50°C		1	1	0.75	0.75	0.75	W
At ambient temperatures above 50°C	Derate linearly at	6.7	6.7	5	5	5	mW/°C
*TEMPERATURE RANGE:							
Storage and Operating (Junction)		-65 to +200					°C
*LEAD TEMPERATURE (During soldering):							
At distance $\geq 1/32$ in. (0.8 mm) from seating plane for 10 s max.		255					°C

*2N-Series types in accordance with JEDEC registration data format (US-9 RDF-8)

TERMINAL DESIGNATIONS



JEDEC TO-39

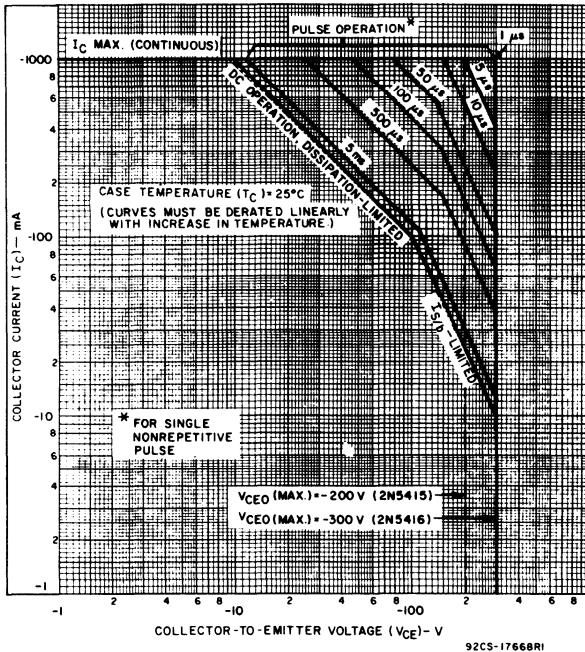


Fig. 1—Maximum safe operating areas for 2N5415 and 2N5416.

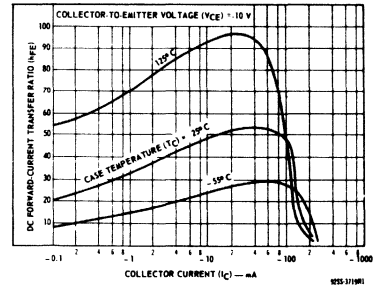


Fig. 2—Typical dc beta characteristics for all types.

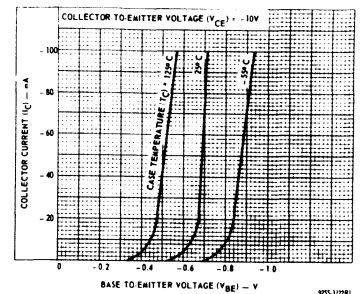


Fig. 3—Typical transfer characteristics for all types.

2N5415, 2N5416, RCS880-RCS882

ELECTRICAL CHARACTERISTICS, Case Temperature (T_C) = 25°C

CHARACTERISTIC SYMBOL	TEST CONDITIONS					LIMITS										UNITS
	VOLTAGE V dc			CURRENT mA dc		2N5415		2N5416		RCS880		RCS881		RCS882		
	V _{CB}	V _{CE}	V _{BE}	I _C	I _B	MIN.	MAX.	MIN.	MAX.	MIN.	MAX.	MIN.	MAX.	MIN.	MAX.	
I _{CEO}		-250 -150 -100			0 0 0	-	-	-	-50	-	-	-	-	-	-50	μA
I _{CBO}	-280 -175					-	-	-	-50	-	-	-	-	-	-50	μA
I _{CEV}		-300 -200 -150	1.5 1.5 1.5			-	-50	-	-	-	-	-	-50	-	-50	μA
I _{EBO}			6 4	0 0		-	-20	-	-20	-	-30	-	-20	-	-20	μA
h _{FE}		-10 -10 -10		-50 ^b -50 ^b -35 ^b		-	30	150	30	120	20	150	-	-	-	
V _{CEO(sus)}				-50	0	-200 ^a	-	-300 ^a	-	-150 ^a	-	-250 ^a	-	-300 ^a	-	V
V _{CER(sus)} (R _{BE}) = 50 Ω				-50		-	-	-350 ^a	-	-	-	-	-	-350 ^a	-	V
V _{BE(sat)}		-10		-50 ^b		-	-1.5	-	-1.5	-	-2.5	-	-1.5	-	-1.5	V
V _{CE(sat)}				-50 ^b	-5	-	-2.5	-	-2	-	-3.5	-	-3	-	-3	V
h _{fe} (at 1 kHz)		-10		-5		25	-	25	-	-	-	-	-	-	-	
h _{fe} (at 5 MHz)		-10		-10		3	-	3	-	3	-	3	-	3	-	
Re(h _{ie}) (at 1 MHz)		-10		-5		-	300	-	300	-	-	-	300	-	300	Ω
C _{ib} (at 1 MHz)			5	0		-	75	-	75	-	-	-	75	-	75	pF
C _{ob} (at 1 MHz)	-10					-	15	-	15	-	-	-	15	-	15	pF
I _{s/b} t _p = 0.4 s nonrep. t _p = 0.2 s nonrep.		-100 -75				-100	-	-100	-	-	-	-	-100	-	-100	mA
RθJC						-	17.5	-	17.5	-	23.3	-	23.3	-	23.3	°C/W

* 2N-Series types in accordance with JEDEC registration data format (JS-9 RDF-8).

^a CAUTION: The sustaining voltages V_{CEO(sus)} and V_{CER(sus)} MUST NOT be measured on a curve tracer.

^b Pulsed: Pulse = 300 μs; duty factor ≤ 2%.

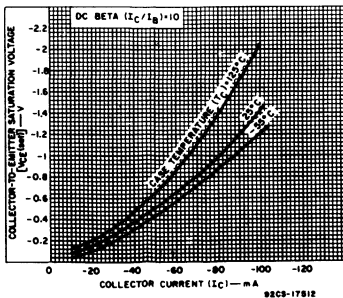


Fig. 4—Typical collector-to-emitter saturation voltage for all types.

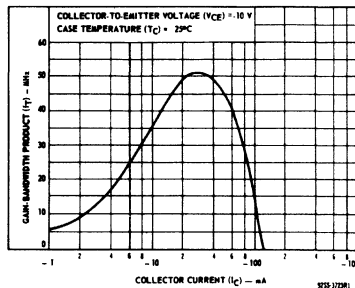


Fig. 5—Typical gain-bandwidth product for all types.

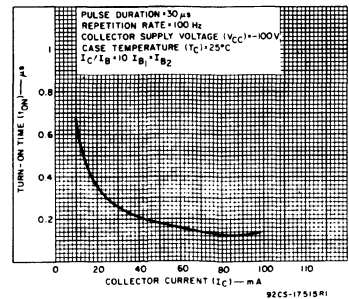


Fig. 6—Typical turn-on time characteristic for 2N5415 and 2N5416.

2N5415, 2N5416, RCS880-RCS882

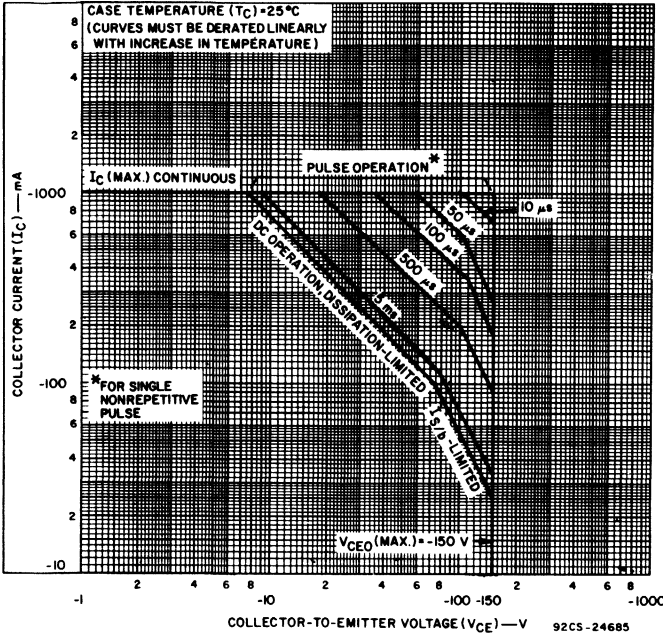


Fig. 7—Maximum safe operating areas for RCS880.

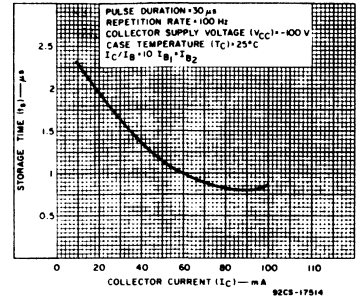


Fig. 8—Typical storage-time characteristic for 2N5415 and 2N5416.

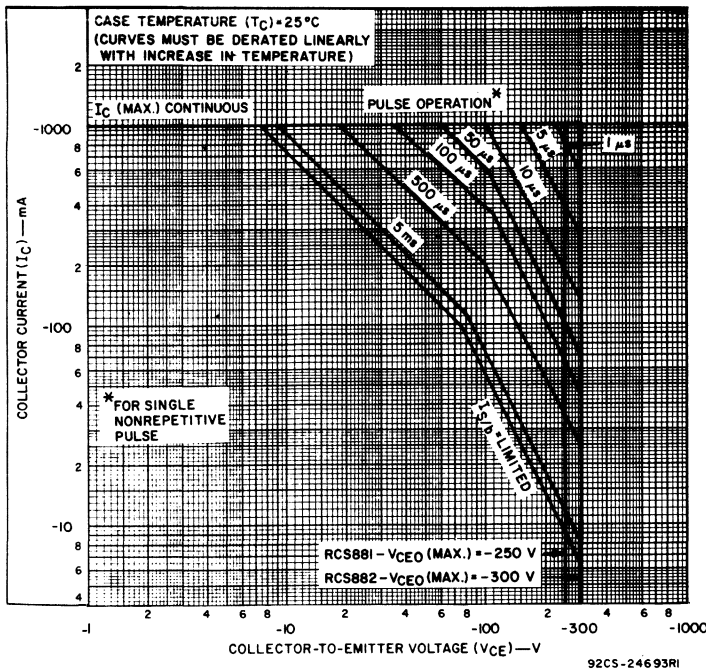


Fig. 9—Maximum safe operating areas for RCS881 and RCS882.

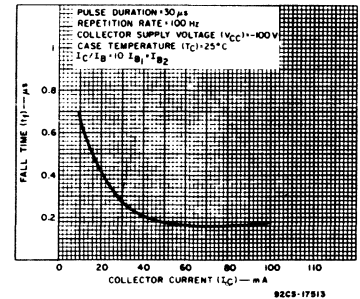


Fig. 10—Typical fall-time characteristic for 2N5415 and 2N5416

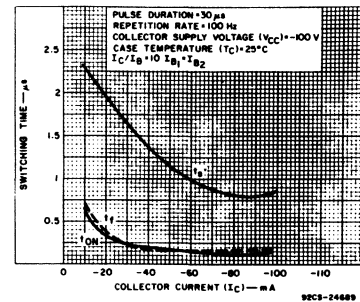


Fig. 11—Typical saturated switching times for RCS880, RCS881 and RCS882.

2N5490, 2N5491, 2N5492, 2N5493, 2N5494, 2N5495, 2N5496, 2N5497

Hometaxial-Base, Silicon N-P-N VERSAWATT Transistors

General-Purpose Types for Medium-Power Switching and Amplifier Applications in Military, Industrial, and Commercial Equipment

RCA-2N5490, 2N5491, 2N5492, 2N5493, 2N5494, 2N5495, 2N5496 and 2N5497* are hometaxial-base silicon n-p-n transistors. They are intended for a wide variety of medium-power switching and amplifier applications, such as series and shunt regulators and driver and output stages of high-fidelity amplifiers.

Types 2N5491, 2N5493, 2N5495, and 2N5497 have formed emitter and base leads for insertion into TO-66 sockets. Types 2N5490, 2N5492, 2N5494, and 2N5496 are electrically identical to the 2N5491, 2N5493, 2N5495, and 2N5497 but have straight leads.

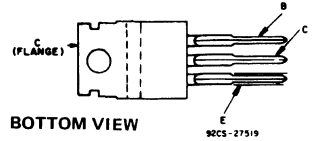
These plastic-package power transistors differ in voltage ratings and in the currents at which the parameters are controlled.

*Formerly RCA Dev. Nos. TA7317, TA7318, TA7315, TA7316, TA7313, TA7314, TA7311, TA7312, respectively.

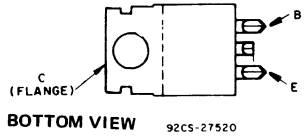
FEATURES

- Low saturation voltage—
 $V_{CE(sat)} = 1\text{ V max. at } I_C = 2\text{ A (2N5490, 2N5491)}$
 $= 1\text{ V max. at } I_C = 2.5\text{ A (2N5492, 2N5493)}$
 $= 1\text{ V max. at } I_C = 3\text{ A (2N5494, 2N5495)}$
 $= 1\text{ V max. at } I_C = 3.5\text{ A (2N5496, 2N5497)}$
- VERSAWATT package (molded silicone plastic)
- Maximum safe-area-of-operation curves specified for DC and pulse operation

TERMINAL DESIGNATIONS



JEDEC TO-220AB
2N5490 2N5494
2N5492 2N5496



JEDEC TO-220AA
2N5491 2N5495
2N5493 2N5497

Maximum Ratings, Absolute-Maximum Values:

	2N5490 2N5491 2N5494 2N5495	2N5492 2N5493	2N5496 2N5497	
COLLECTOR-TO-BASE VOLTAGE V_{CB0}	60	75	90	V
COLLECTOR-TO-EMITTER SUSTAINING VOLTAGE:				
With -1.5 volts (V_{BE}) of reverse bias $V_{CEV(sus)}$	60	75	90	V
With external base-to-emitter resistance (R_{BE}) $V_{CER(sus)}$	50	65	80	V
With base open $V_{CEO(sus)}$	40	55	70	V
EMITTER-TO-BASE VOLTAGE V_{EB0}	5	5	5	V
COLLECTOR CURRENT I_C	7	7	7	A
BASE CURRENT I_B	3	3	3	A
TRANSISTOR DISSIPATION: P_T				
At case temperatures up to 25°C	50	50	50	W
At ambient temperatures up to 25°C	1.8	1.8	1.8	W
At case temperatures above 25°C	Derate linearly at 0.4 W/°C or see Figs. 1 & 2			
At ambient temperatures above 25°C	Derate linearly at 0.0144 W/°C			
TEMPERATURE RANGE:				
Storage & Operating (Junction)	← -65 to 150 →			°C
LEAD TEMPERATURE (During Soldering):				
At distance $\geq 1/8$ in. (3.17 mm) from case for 10 s max	← 235 →			°C

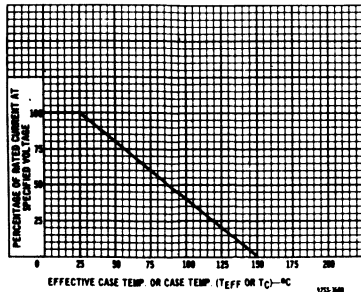


Fig. 1 - Derating curve for types 2N5490 through 2N5497 inclusive.

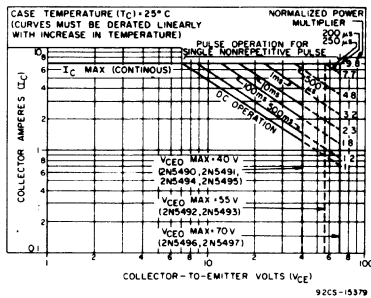


Fig. 2 - Maximum operating areas for types 2N5490 through 2N5497 inclusive.

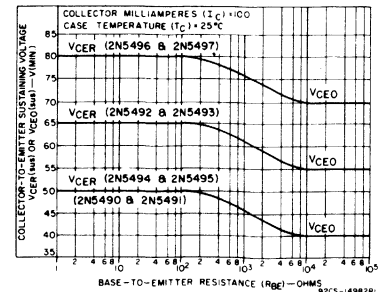


Fig. 3 - Collector-to-emitter sustaining voltage characteristics for types 2N5490 through 2N5497 inclusive.

2N5490, 2N5491, 2N5492, 2N5493, 2N5494, 2N5495, 2N5496, 2N5497

ELECTRICAL CHARACTERISTICS, Case Temperature (T_C) = 25°C Unless Otherwise Specified

Characteristic	Symbol	TEST CONDITIONS				LIMITS								Units	
		DC Voltage (V)		DC Current (A)		Types 2N5496 2N5497		Types 2N5494 2N5495		Types 2N5492 2N5493		Types 2N5490 2N5491			
		V_{CE}	V_{BE}	I_C	I_B	Min.	Max.	Min.	Max.	Min.	Max.	Min.	Max.		
Collector-Cutoff Current With base-emitter junction reverse biased	I_{CEV}	85 55 70	-1.5 -1.5 -1.5			-	1	-	-	-	-	-	-	mA	
	I_{CEV} ($T_C = 150^\circ\text{C}$)	85 55 70	-1.5 -1.5 -1.5			-	5	-	-	-	-	-	-	mA	
Collector-Cutoff Current With external base-to-emitter resistance (R_{BE}) = 100 Ω	I_{CER}	70 40 55				-	0.5	-	-	-	-	-	-	mA	
	I_{CER} ($T_C = 150^\circ\text{C}$)	70 40 55				-	3.5	-	-	-	-	-	-	mA	
Emitter-Cutoff Current	I_{EBO}		-5			-	1	-	1	-	1	-	1	mA	
DC Forward-Current Transfer Ratio	h_{FE}^c	4		3.5		20	100	-	-	-	-	-	-		
		4		3		-	-	20	100	-	-	-	-		
		4		2.5		-	-	-	-	20	100	-	-		
		4		2		-	-	-	-	-	-	20	100		
Collector-to-Emitter Sustaining Voltage: With base open	$V_{CE(sus)}^f$			0.1	0	70	-	40	-	55	-	40	-	V	
With external base-to-emitter resistance (R_{BE}) = 100 Ω	$V_{CE(sus)}^f$			0.1		80	-	50	-	65	-	50	-	V	
With base-emitter junction reverse biased	$V_{CE(sus)}^f$		-1.5	0.1		90	-	60	-	75	-	60	-	V	
Base-to-Emitter Voltage	V_{BE}^c	4		3.5		-	1.7	-	-	-	-	-	-	V	
		4		3		-	-	-	1.5	-	-	-	-	V	
		4		2.5		-	-	-	-	-	1.3	-	-	V	
		4		2		-	-	-	-	-	-	-	1.1	V	
Collector-to-Emitter Saturation Voltage	$V_{CE(sat)}^c$			3.5	0.35	-	1	-	-	-	-	-	-	V	
				3	0.3	-	-	-	1	-	-	-	-	V	
				2.5	0.25	-	-	-	-	-	1	-	-	V	
				2	0.2	-	-	-	-	-	-	-	1	V	
Gain-Bandwidth Product	f_T	4		0.5		0.8	-	0.8	-	0.8	-	0.8	-	MHz	
Sat. Switching Time: Turn-On	t_{on}	$V_{CC} = 30$		3.5	0.35 ^a	-	5	-	-	-	-	-	-	μs	
				3	0.3 ^a	-	-	-	5	-	-	-	-	μs	
				2.5	0.25 ^a	-	-	-	-	-	5	-	-	-	μs
				2	0.2	-	-	-	-	-	-	-	5	-	μs
Turn-Off	t_{off}	$V_{CC} = 30$		3.5	0.35 ^b	-	15	-	-	-	-	-	-	μs	
				3	0.3 ^b	-	-	-	15	-	-	-	-	μs	
				2.5	0.25 ^b	-	-	-	-	-	15	-	-	-	μs
				2	0.2	-	-	-	-	-	-	-	15	-	μs
Thermal Resistance: Junction-to-Case	θ_{J-C}					-	2.5	-	2.5	-	2.5	-	2.5	$^\circ\text{C/W}$	
Junction-to-Ambient	θ_{J-A}					-	70	-	70	-	70	-	70	$^\circ\text{C/W}$	

^a I_{B1} value (turn-on base current).^b I_{B2} value (turn-off base current).^c Pulsed, pulse duration = 300 μs , duty factor = .018.

2N5490, 2N5491, 2N5492, 2N5493, 2N5494, 2N5495, 2N5496, 2N5497

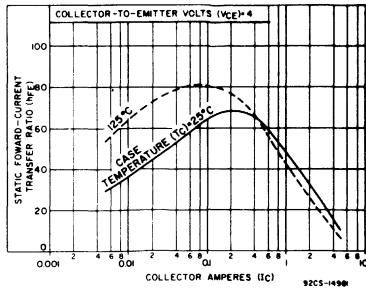


Fig. 4 - Typical static beta characteristics for types 2N5490 through 2N5493 inclusive.

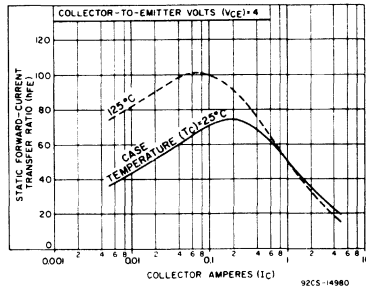


Fig. 5 - Typical static beta characteristics for types 2N5494 and 2N5495.

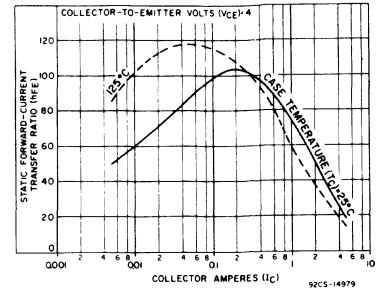


Fig. 6 - Typical static beta characteristics for types 2N5496 and 2N5497.

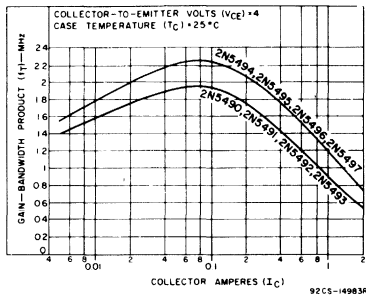


Fig. 7 - Typical gain-bandwidth product for types 2N5490 through 2N5497 inclusive.

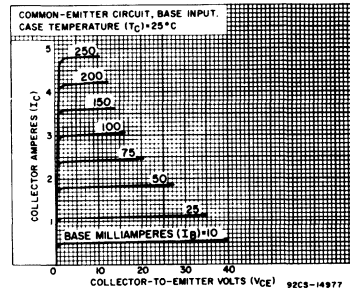


Fig. 8 - Typical output characteristics for types 2N5494 through 2N5497 inclusive.

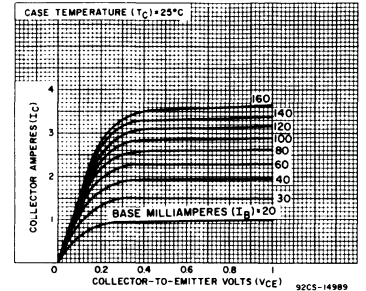


Fig. 9 - Typical output characteristics for types 2N5494 and 2N5495.

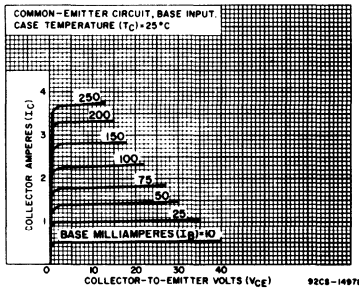


Fig. 10 - Typical output characteristics for types 2N5490 through 2N5493 inclusive.

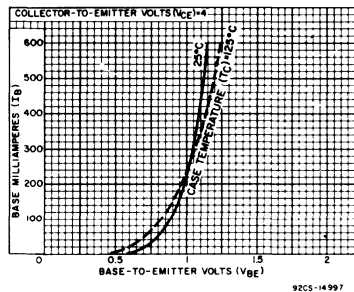


Fig. 11 - Typical input characteristics for types 2N5494 through 2N5497 inclusive.

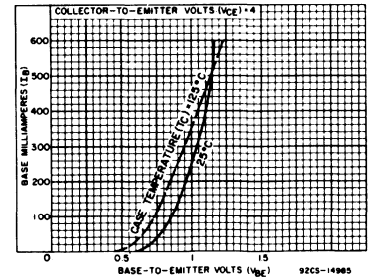


Fig. 12 - Typical input characteristics for types 2N5490 through 2N5493 inclusive.

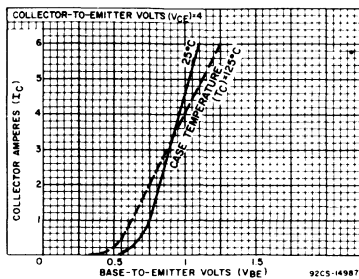


Fig. 13 - Typical transfer characteristics for types 2N5494 through 2N5497 inclusive.

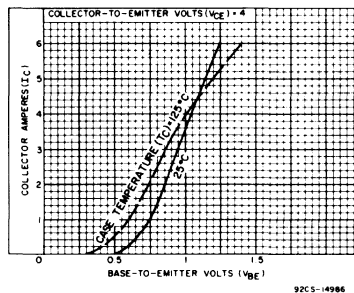


Fig. 14 - Typical transfer characteristics for types 2N5490 through 2N5493 inclusive.

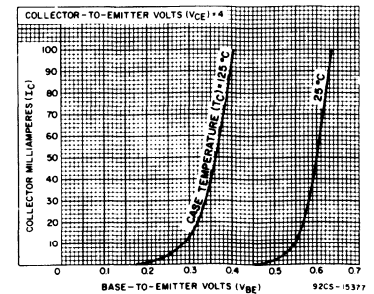


Fig. 15 - Typical transfer characteristics for types 2N5490 through 2N5497 inclusive.

2N5575, 2N5578

High-Current, High-Power, Hometaxial-Base Silicon N-P-N Transistors

For Linear and Switching Applications in Military, Commercial, and Industrial Equipment

RCA-2N5575 and 2N5578* are high-current, high-power, hometaxial-base silicon n-p-n transistors. They differ in maximum voltage and current ratings.

These power transistors are intended for a wide variety of high-current, high-power linear and switching applications such as low- to medium-frequency amplifiers, switching and

linear regulators, power-switching circuits, series- or shunt-regulator driver and output stages, dc-to-dc converters, inverters, control circuits, and solenoid (hammer)/relay drivers.

The high-current capability (100-A peak) makes these types particularly suitable for circuit designs that now require several low-current types connected in parallel.

They are supplied in the Modified JEDEC TO-3 package with 0.060-In. Dia. Pins.

* Formerly RCA Dev. Nos. TA7016 and TA7017, respectively.

MAXIMUM RATINGS, Absolute-Maximum Values:

*COLLECTOR-TO-BASE VOLTAGE	V_{CB0}	70	90	V
*COLLECTOR-TO-EMITTER VOLTAGE:				
With base open, sustaining	$V_{CE0(sus)}$	50	70	V
With external base-to-emitter resistance (R_{BE}) = 10 Ω & V_{BE} = -1.5 V	V_{CEX}	70	90	V
*EMITTER-TO-BASE VOLTAGE	V_{EBO}	8	8	V
*COLLECTOR CURRENT (Continuous)	I_C	80	60	A
*COLLECTOR CURRENT (Peak)		100	80	A
*BASE CURRENT (Continuous)	I_B	20	15	A
*TRANSISTOR DISSIPATION:	P_T			
At case temperatures up to 25°C and V_{CE} up to 25 V		300	300	W
At case temperatures of 100°C and V_{CE} of 25 V		150	150	W
At case temperatures up to 25°C and V_{CE} above 25 V				
At case temperatures above 25°C and V_{CE} above 25 V				
*TEMPERATURE RANGE:				
Operating (Junction)		-65 to 175		°C
Storage		-65 to 200		°C
*PIN TEMPERATURE (During Soldering):				
At distance $\geq 1/32$ in. (0.8 mm) from case for 10 s max.		230		°C

2N5575	2N5578
70	90
50	70
70	90
8	8
80	60
100	80
20	15
300	300
150	150

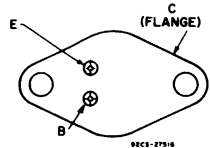
See Fig. 7
See Figs. 1 & 2

* In accordance with JEDEC registration data format JS-6 RDF-1.

Features:

- Maximum safe-area-of operation curves
- I_S/b limit line beginning at 25 V
- High-current capability
- Low saturation voltage at high beta
- High-dissipation capability
- Low thermal resistance

TERMINAL DESIGNATIONS



Modified JEDEC TO-3

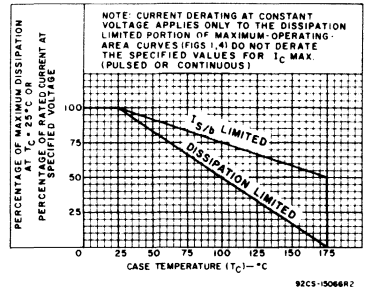


Fig. 1 - Dissipation derating curves for both types.

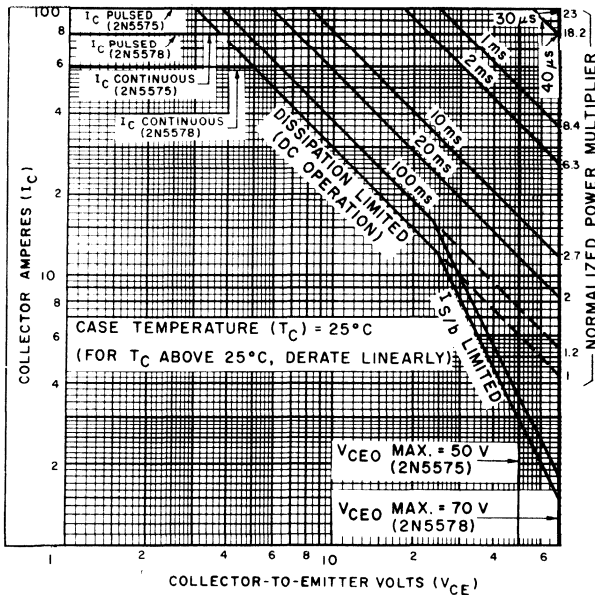


Fig. 2 - Maximum operating areas for both types.

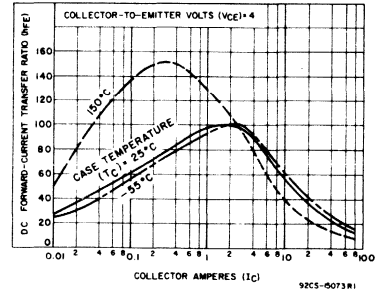


Fig. 3 - Typical dc beta characteristics for 2N5575.

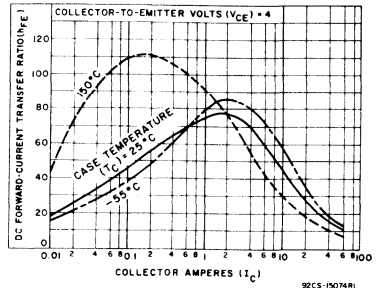


Fig. 4 - Typical dc beta characteristics for 2N5578.

2N5575, 2N5578

ELECTRICAL CHARACTERISTICS, At Case Temperature (T_C) = 25°C Unless Otherwise Specified

CHARACTERISTIC	SYMBOL	TEST CONDITIONS				LIMITS				UNITS	
		Voltage V dc		Current A dc		2N5575		2N5578			
		V_{CE}	V_{BE}	I_C	I_B	Min.	Max.	Min.	Max.		
Collector Cutoff Current: With base-emitter junction reverse-biased	I_{CEV}	60 80	-1.5			-	10	-	-	10	mA
With external base-emitter resistance (R_{BE}) = 10 Ω	I_{CER}	50 70				-	10	-	-	10	mA
With base-emitter junction reverse-biased	I_{CEV} ($T_C = 150^\circ\text{C}$)	60 80	-1.5			-	20	-	-	20	mA
Emitter Cutoff Current	I_{EBO}		-8			-	10	-	-	10	mA
Collector-to-Emitter Breakdown Voltage	$V_{(BR)CEO}$			0.2	0	50	-	70	-	-	V
DC Forward Current Transfer Ratio	h_{FE}^a	3 4		40 ^a 60 ^a		-	-	10	40	-	
Collector-to-Emitter Sustaining Voltage: (See Figs. 5 and 6) With base open	$V_{CEO}(sus)$			0.2		50 ^b	-	70 ^b	-	-	V
With base-emitter junction reverse-biased, $R_{BE} = 10 \Omega$	$V_{CEX}(sus)$		-1.5	7		70 ^b	-	90 ^b	-	-	V
Base-to-Emitter Voltage	V_{BE}^a	4 4		40 ^a 60 ^a		-	-	-	3	-	2.5 V
Collector-to-Emitter Saturation Voltage	$V_{CE}(sat)^a$			40 ^a 60 ^a	4 6	-	-	-	-	1.5	V
Base-to-Emitter Saturation Voltage	$V_{BE}(sat)^a$			40 ^a 60 ^a	4 6	-	-	-	3	-	2.5 V
Output Capacitance: ($V_{CB} = 10 \text{ V}$)	C_{ob}					-	2000	-	2000	-	pF
Input Capacitance	C_{ib}		-0.5	0		-	4000	-	4000	-	pF
Magnitude of Common- Emitter, Small-Signal, Short-Circuit Forward Current Transfer Ratio ($f = 0.2 \text{ MHz}$)	$ h_{fe} $	4		10		2	-	2	-	-	
Saturated Switching Time ($V_{CC} = 30 \text{ V}$)				40	4	-	-	-	-	10	μs
Turn-on time	t_{ON}			60	6	-	15	-	-	-	
Turn-off time	t_{OFF}			40	4	-	-	-	10	-	
Forward-Bias Second-Breakdown Collector Current ($t = 1 \text{ s}$)	$I_{S/b}$	25				12	-	12	-	-	A
Second Breakdown Energy (With base reverse-biased, $R_{BE} = 10 \Omega$, $L = 33 \text{ mH}$)	$E_{S/b}$		-1.5	7		0.8	-	0.8	-	-	J
Thermal Resistance: (Junction-to-Case)	$R_{\theta JC}$					-	0.5	-	0.5	-	$^\circ\text{C/W}$

^aIn accordance with JEDEC registration data format JS-6 RDF-1.

^bPulsed; pulse duration $\leq 350 \mu\text{s}$, duty factor = 0.02.

^cCAUTION: The sustaining voltages $V_{CEO}(sus)$ and $V_{CEX}(sus)$ MUST NOT be measured on a curve tracer.

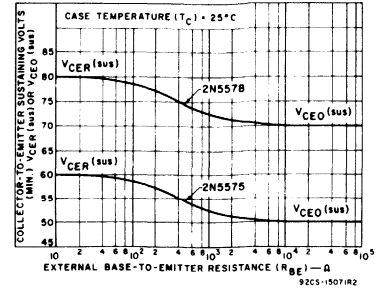


Fig. 5 - Collector-to-emitter sustaining voltage characteristics for both types.

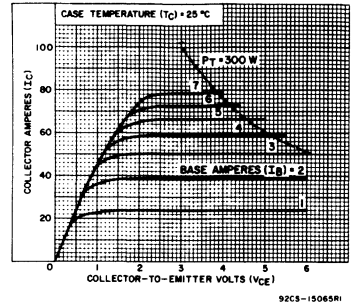


Fig. 6 - Typical output characteristics for 2N5575.

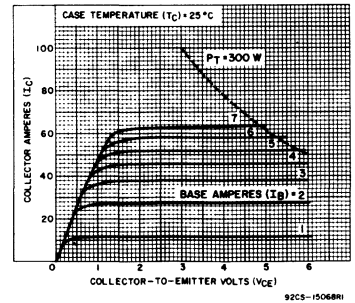


Fig. 7 - Typical output characteristics for 2N5578.

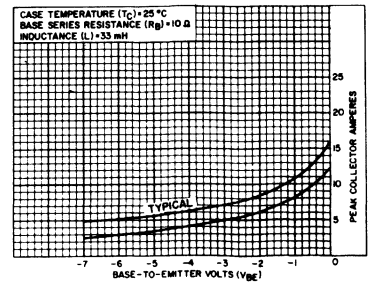


Fig. 8 - Reverse-bias second-breakdown characteristics for both types.

2N5575, 2N5578

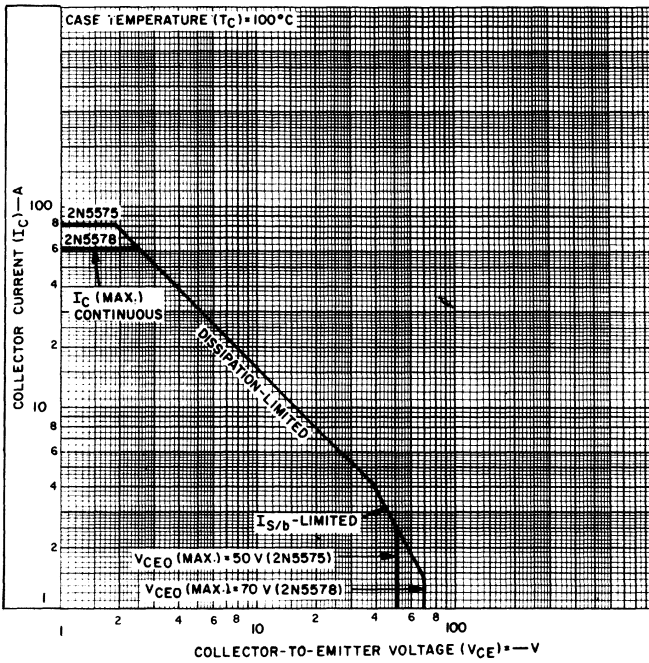


Fig. 9 - Maximum operating areas for both types at $T_C = 100^\circ\text{C}$.

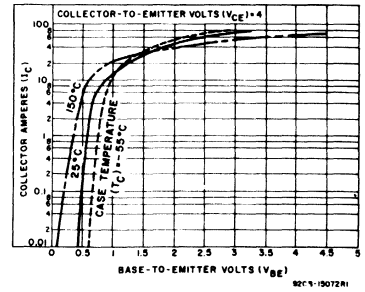


Fig. 10 - Typical transfer characteristics for 2N5575.

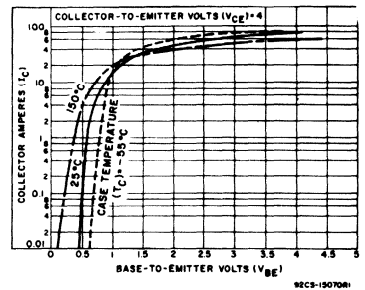


Fig. 11 - Typical transfer characteristics for 2N5578.

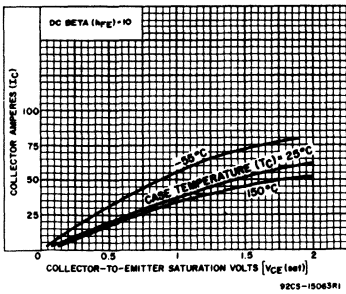


Fig. 12 - Typical saturation voltage characteristics for 2N5575.

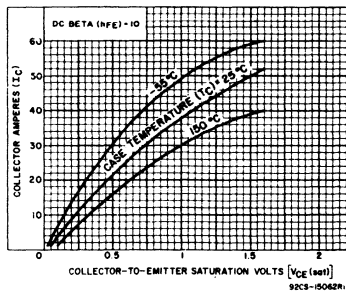


Fig. 13 - Typical saturation voltage characteristics for 2N5578.

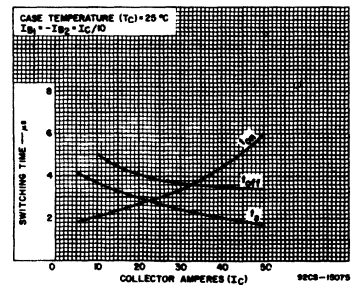


Fig. 14 - Typical saturated switching characteristics for both types.

2N5632, 2N5633, 2N5634

Silicon N-P-N Epitaxial-Base High-Power Transistors

Rugged, Broadly Applicable Devices
For Industrial and Commercial Use

The RCA-2N5632, 2N5633 and 2N5634 are epitaxial-base silicon n-p-n transistors intended for a wide variety of high-power, high-current applications, such as power-switching circuits, driver and output stages for series and shunt regulators, dc-to-dc converters, inverters, and solenoid (hammer)/relay drivers.

These devices differ in maximum voltage ratings. They are supplied in JEDEC TO-204MA hermetic steel packages.

Features:

- High dissipation capability
- Low saturation voltages
- Maximum safe-area-of-operation curves
- Hermetically sealed JEDEC TO-3/TO-204MA package
- High gain at high current

Applications:

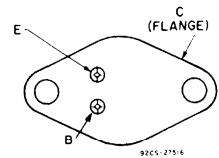
- Series and shunt regulators
- High-fidelity amplifiers
- Power-switching circuits
- Solenoid drivers

MAXIMUM RATINGS, Absolute-Maximum Values:

	2N5632	2N5633	2N5634	
* V_{CE0}	100	120	140	V
* V_{CBO}	100	120	140	V
* V_{EBO}	7	7	7	V
* I_C	10	10	10	A
* I_{CM}	15	15	15	A
* I_B	5	5	5	A
* P_T		150		W
At $T_C \leq 25^\circ\text{C}$		0.857		$\text{W}/^\circ\text{C}$
At $T_C > 25^\circ\text{C}$		derate linearly		$^\circ\text{C}$
* T_J, T_{stg}		-65 to 200		$^\circ\text{C}$
* T_L at $1/16 \pm 1/32$ in. (1.58 ± 0.8 mm) from case for 10 s		235		$^\circ\text{C}$

* In accordance with JEDEC registration data.

TERMINAL DESIGNATIONS



JEDEC TO-204MA

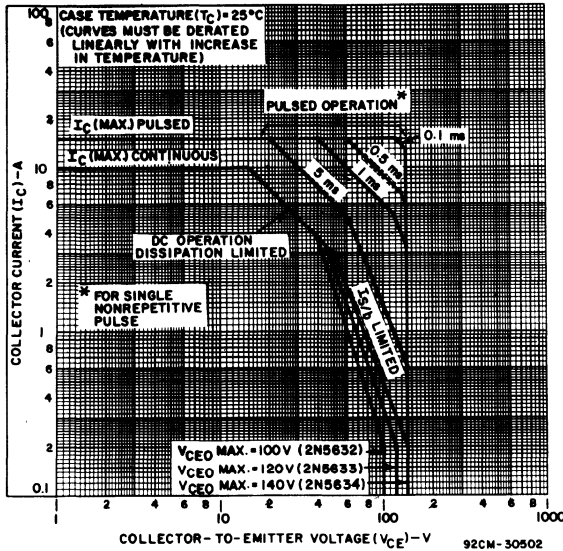


Fig. 1 - Maximum operating areas for all types.

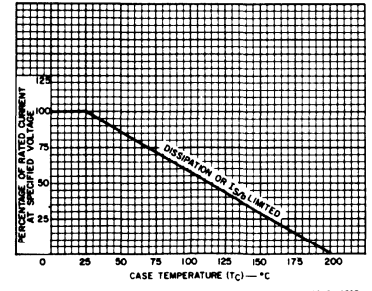


Fig. 2 - Current derating curve for all types.

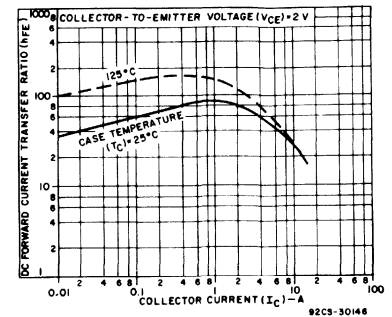


Fig. 3 - Typical dc beta characteristics as a function of collector current for all types.

2N5632, 2N5633, 2N5634

ELECTRICAL CHARACTERISTICS, At Case Temperature $T_C = 25^\circ\text{C}$
Unless Otherwise Specified

CHARACTERISTIC	TEST CONDITIONS				LIMITS						UNITS
	VOLTAGE V dc		CURRENT A dc		2N5632		2N5633		2N5634		
	V_{CE}	V_{BE}	I_C	I_B	Min.	Max.	Min.	Max.	Min.	Max.	
I_{CEX}	100	-1.5	-	-	-	1.0	-	-	-	-	mA
	120	-1.5	-	-	-	-	-	1.0	-	-	
	140	-1.5	-	-	-	-	-	-	-	1.0	
$T_C = 150^\circ\text{C}$	100	-1.5	-	-	-	5.0	-	-	-	-	mA
	120	-1.5	-	-	-	-	-	5.0	-	-	
	140	-1.5	-	-	-	-	-	-	-	5.0	
I_{CEO}	50	-	-	0	-	1.0	-	-	-	-	mA
	60	-	-	0	-	-	-	1.0	-	-	
	70	-	-	0	-	-	-	-	-	1.0	
I_{CBO} $I_E = 0$ $V_{CB} = \text{Rated } V_{CB}$	100	-	-	-	-	1.0	-	-	-	-	mA
	120	-	-	-	-	-	-	1.0	-	-	
	140	-	-	-	-	-	-	-	-	1.0	
I_{EBO}	-	7	-	-	-	1.0	-	1.0	-	1.0	mA
$V_{CEO(sus)}^b$	-	-	0.2	0	100	-	120	-	140	-	V
h_{FE}^a	2	-	5	-	25	100	20	80	15	60	
	2	-	10	-	5	-	5	-	5	-	
V_{BE}^a	2	-	5	-	1.5	-	1.5	-	1.5	-	V
$V_{CE(sat)}^a$	-	-	7.5	0.75	-	1.0	-	1.0	-	1.0	V
	-	-	10	2.0	-	2.0	-	2.0	-	2.0	
f_T $f = 0.5$ MHz	20	-	1	-	1	-	1	-	1	-	MHz
h_{fe} $f = 1$ kHz	10	-	2.0	-	15	-	15	-	15	-	
$V_{BE(sat)}$			7.5	0.75	-	2.0	-	2.0	-	2.0	V
C_{obo} $f = 0.1$ MHz $I_E = 0$	10 ^c				-	300	-	300	-	300	pF
I_S/b $t_p = 1$ s nonrep.	50				3.0	-	-	-	-	-	A
	45				-	-	3.33	-	-	-	
	40				-	-	-	-	3.75	-	
$R_{\theta JC}$	-	-	-	-	-	1.17	-	1.17	-	1.17	$^\circ\text{C/W}$

^a In accordance with JEDEC registration data.

^b Pulsed; pulse duration $\leq 300 \mu\text{s}$. Duty factor $\leq 2\%$.

^c CAUTION: Sustaining voltage, $V_{CEO(sus)}$ MUST NOT BE measured on a curve tracer.

^c V_{CB}

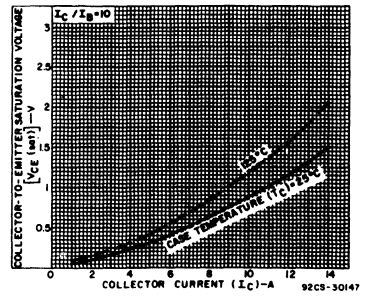


Fig. 4 - Typical saturation voltage characteristics for all types.

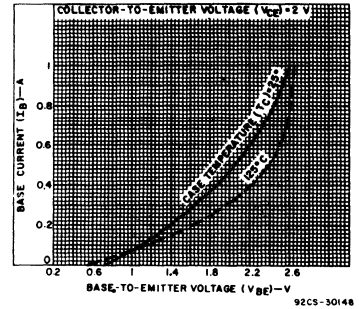


Fig. 5 - Typical input characteristics for all types.

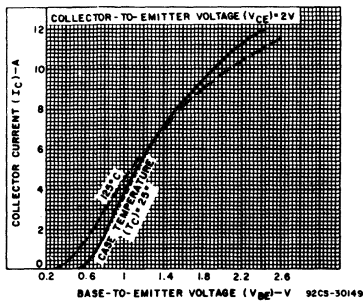


Fig. 6 - Typical transfer characteristics for all types.

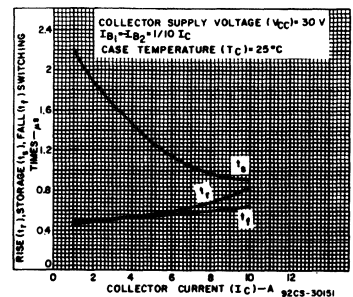


Fig. 7 - Typical saturated-switching times for all types.

2N5671, 2N5672

Silicon N-P-N Power Transistors

High-Current, High-Speed, High-Power Types for Switching and Amplifier Applications

RCA Types 2N5671 and 2N5672^A are epitaxial silicon n-p-n transistors having high current and high power handling capability and fast switching speed. The 2N5672 is similar to the 2N5671 except that it has higher voltage ratings and lower leakage currents. These devices are especially suitable for switching-control amplifiers, power gates, switching regulators, power-switching circuits, converters, inverters, control circuits. Other recommended applications included DC-RF amplifiers and power oscillators.

They are supplied in the JEDEC TO-3 hermetic steel package.

^A Formerly Dev. Types TA7323 and TA7323A, respectively

MAXIMUM RATINGS, Absolute-Maximum Values:

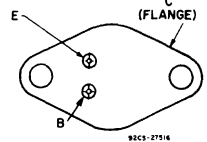
	2N5671	2N5672
* COLLECTOR-TO-BASE VOLTAGE, V_{CBO}	120	150
COLLECTOR-TO-EMITTER SUSTAINING VOLTAGE:		
With base open, $V_{CEO}(sus)$	90	120
With external base-to-emitter resistance (R_{BE}) $\leq 50 \Omega$, $V_{CE}(sus)$	110	140
With external base-to-emitter resistance (R_{BE}) $\leq 50 \Omega$ & $V_{BE} = -1.5$, $V_{CEX}(sus)$	120	150
* EMITTER-TO-BASE VOLTAGE, V_{EBO}	7	7
* COLLECTOR CURRENT, I_C	30	30
* BASE CURRENT, I_B	10	10
* TRANSISTOR DISSIPATION, P_T :		
At case temperatures up to 25°C and V_{CE} up to 24 V	140	140
At case temperatures up to 25°C and V_{CE} above 24 V	See Fig. 1	
At case temperatures above 25°C and V_{CE} above 24 V	See Figs. 1&2.	
* TEMPERATURE RANGE:		
Storage & Operating (Junction)	-65 to +200	°C
* PIN TEMPERATURE (During Soldering)		
At distances $\geq 1/32$ in. from seating plane for 10 s max	230	°C

*In accordance with JEDEC registration data format (JS-6, RFD-1)

Features:

- Maximum Safe-Area-of-Operation Curves . . . $I_{S/B}$ limit line beginning at 24 V
- Fast Turn-On Time . . . $t_{on} = 0.5 \mu s$ max. at $I_C = 15 A$
- High-Current Capability . . . h_{FE} , $V_{CE}(sat)$, $V_{BE}(sat)$, & V_{BE} measured at $I_C = 15 A$
- Low $V_{CE}(sat) = 0.75 V$ max.
- High $P_T = 140 W$ max. at $T_C = 25^\circ C$

TERMINAL DESIGNATIONS



JEDEC TO-3

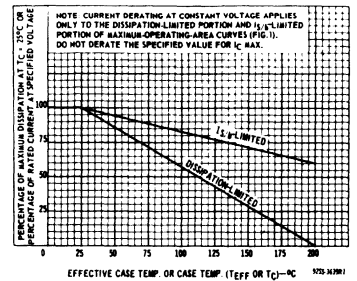


Fig. 2 - Dissipation derating curves for types 2N5671 and 2N5672.

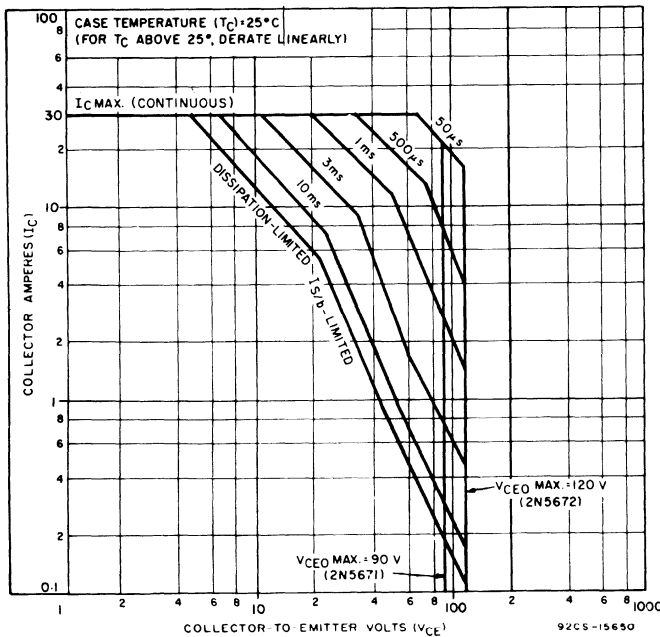


Fig. 1 - Maximum operating areas for types 2N5671 and 2N5672.

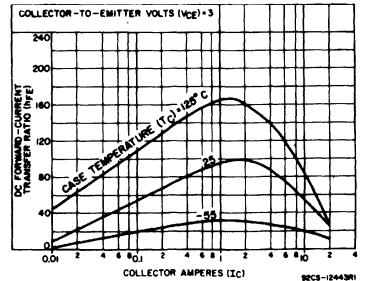


Fig. 3 - Typical dc beta characteristics for types 2N5671 and 2N5672.

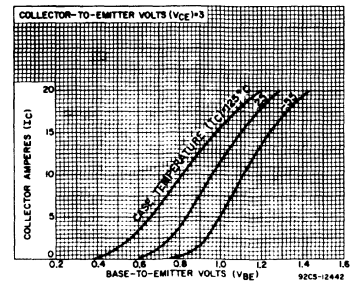


Fig. 4 - Typical transfer characteristics for types 2N5671 and 2N5672.

2N5671, 2N5672

ELECTRICAL CHARACTERISTICS, Case Temperature (T_C) = 25°C Unless Otherwise Specified

CHARACTERISTIC	SYMBOL	TEST CONDITIONS						LIMITS				UNITS
		DC Voltage (V)			DC Current (A)			Type 2N5671		Type 2N5672		
		V_{CB}	V_{CE}	V_{BE}	I_C	I_B	Min.	Max.	Min.	Max.		
* Collector-Cutoff Current	I_{CEO}	-	80	-	-	0	-	10	-	10	mA	
	I_{CEV}	-	110	-1.5	-	-	-	12	-	-	mA	
	I_{CEV}	-	135	-1.5	-	-	-	10	-	10	mA	
	I_{CEV} ($T_C=150^\circ\text{C}$)	-	100	-1.5	-	-	-	15	-	10	mA	
* Emitter-Cutoff Current	I_{EBO}	-	-	-7	0	-	-	10	-	10	mA	
Collector-to-Emitter Sustaining Voltage: With base open	$V_{CEO(sus)}$	-	-	-	0.2	0	90 ^a	-	120 ^a	-	V	
With external base-to-emitter resistance ($R_{BE} \leq 50\Omega$)	$V_{CER(sus)}$	-	-	-	0.2	0	110 ^a	-	140 ^a	-	V	
With base-emitter junction reverse biased & $R_{BE} \leq 50\Omega$	$V_{CEX(sus)}$	-	-	-1.5	0.2	-	120 ^a	-	150 ^a	-	V	
* Base-to-Emitter Saturation Voltage	$V_{BE(sat)}$	-	-	-	15	1.2	-	1.5	-	1.5	V	
Base-to-Emitter Voltage	V_{BE}	-	5	-	15	-	-	1.6	-	1.6	V	
* Collector-to-Emitter Saturation Voltage	$V_{CE(sat)}$	-	-	-	15	1.2	-	0.75	-	0.75	V	
* DC Forward-Current Transfer Ratio	h_{FE}	-	2	-	15	-	20	100	-	20	100	
* Second-Breakdown Collector Current ^c With base forward biased	$I_{S/b}$	-	24	-	-	-	5.8 ^e	-	5.8 ^e	-	A	
		-	45	-	-	-	-	0.9 ^e	-	0.9 ^e	-	A
Second-Breakdown Energy With base reverse biased $R_{BE} = 20\Omega, L = 180\mu\text{H}$	$E_{S/b}$ ^d	-	-	-4	15	-	20	-	20	-	mJ	
Gain-Bandwidth Product	f_T	-	10	-	2	-	50	-	50	-	MHz	
Output Capacitance ($A_1 = 1\text{ MHz}, I_E = 0$)	C_{ob}	10	-	-	-	-	-	900	-	900	pF	
* Saturated Switching Turn-On Time (Delay Time + Rise Time)	t_{on}	$V_{CC} = 30\text{ V}$	-	-	15	$I_{B1} = 1.2$ $I_{B2} = 1.2$	-	0.5	-	0.5	μs	
* Saturated Switching Storage Time	t_s	$V_{CC} = 30\text{ V}$	-	-	15	$I_{B1} = 1.2$ $I_{B2} = 1.2$	-	1.5	-	1.5	μs	
* Saturated Switching Fall Time	t_f	$V_{CC} = 30\text{ V}$	-	-	15	$I_{B1} = 1.2$ $I_{B2} = 1.2$	-	0.5	-	0.5	μs	
Thermal Resistance (Junction-to-Case)	$R_{\theta JC}$	-	10	-	5	-	-	1.25	-	1.25	$^\circ\text{C/W}$	

^aPulsed, pulse duration $\leq 350\mu\text{s}$, duty factor ≤ 0.02

^bCAUTION: The sustaining voltages $V_{CEO(sus)}$ and $V_{CEX(sus)}$ MUST NOT be measured on a curve tracer.

^c $I_{S/b}$ is defined as the current at which second breakdown occurs at a specified collector voltage with the emitter-base junction forward biased for transistor operation in the active region.

^dPulsed, 1 s, non-repetitive pulse.

^e $E_{S/b}$ is defined as the energy at which second breakdown occurs under specified reverse bias conditions. $E_{S/b} = I^2/2L^2$ where L is a series load or leakage inductance and I is the peak collector current.

^fIn accordance with JEDEC registration data format JS-6 RDF-1.

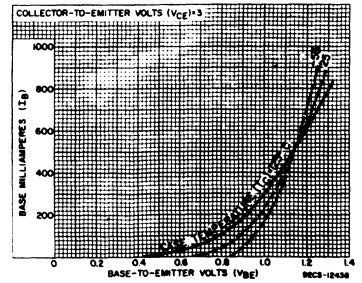


Fig. 5 - Typical input characteristics for types 2N5671 and 2N5672.

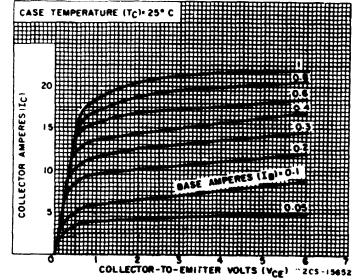


Fig. 6 - Typical output characteristics for types 2N5671 and 2N5672.

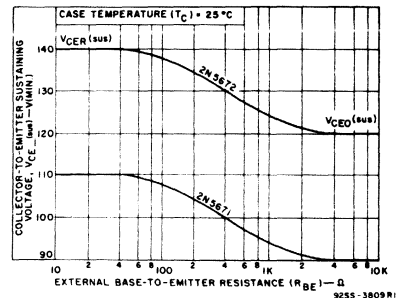


Fig. 7 - Collector-to-emitter sustaining voltage characteristics for types 2N5671 and 2N5672.

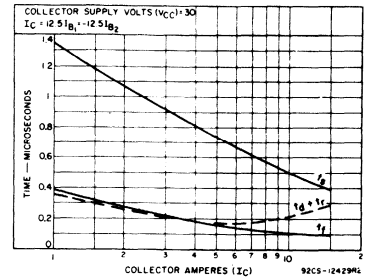


Fig. 8 - Typical saturated switching characteristics for types 2N5671 and 2N5672.

2N5781-2N5786

Silicon N-P-N and P-N-P Epitaxial-Base Complementary-Symmetry Transistors

General-Purpose Types for Switching and Linear-Amplifier Applications

RCA-2N5781, 2N5782, and 2N5783 are epitaxial-base silicon p-n-p transistors - complements of the homotaxial-base silicon n-p-n types 2N5784, 2N5785, and 2N5786,* respectively.

The three types in each family differ primarily in voltage ratings and saturation characteristics.

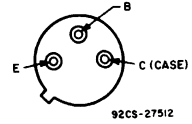
These transistors are intended for medium-power switching and complementary-symmetry audio amplifier applications.

* Formerly RCA Dev. Types TA7270, TA7271, TA7272, TA7289, TA7290, and TA7291 respectively.

Features:

- Low saturation voltages
- Maximum safe-area-of-operation curves
- Hermetically sealed package
- High gain at high current
- High breakdown voltages

TERMINAL DESIGNATIONS



MAXIMUM RATINGS, Absolute-Maximum Values:

	SYMBOL	P-N-P			UNITS
		2N5781*	2N5782*	2N5783*	
COLLECTOR-TO-BASE VOLTAGE	V_{CBO}	80	65	45	V
COLLECTOR-TO-EMITTER SUSTAINING VOLTAGE:					
With external base-to-emitter resistance (R_{BE}) = 100 Ω	$V_{CER(sus)}$	80	65	45	V
With base open	$V_{CEO(sus)}$	65	50	40	V
EMITTER-TO-BASE VOLTAGE	V_{EBO}	5	5	3.5	V
CONTINUOUS COLLECTOR CURRENT	I_C	3.5	3.5	3.5	A
CONTINUOUS BASE CURRENT	I_B	1	1	1	A
TRANSISTOR DISSIPATION:	P_T				
At case temperatures up to 25°C		10	10	10	W
At ambient temperatures up to 25°C		1	1	1	W
At case temperatures above 25°C		Derate linearly			
At ambient temperatures above 25°C		0.057 W/°C, or see Fig. 1			W/°C
TEMPERATURE RANGE:					
Storage and operating (Junction)		-65 to +200			°C
LEAD TEMPERATURE (During soldering):					
At distance \geq 1/32 in. (0.8 mm) from seating plane for 10 s max.		230			°C

*In accordance with JEDEC registration data form: JS-8 RDF-2.

*For p-n-p devices, voltage and current values are negative.

ELECTRICAL CHARACTERISTICS, At Case Temperature (T_C) = 25°C unless otherwise specified

CHARACTERISTIC	SYMBOL	TEST CONDITIONS*				LIMITS				UNITS
		VOLTAGE		CURRENT		2N5781		2N5784		
		V dc	A dc	p-n-p	n-p-n	Min.	Max.	Min.	Max.	
Collector Cutoff Current:	I_{CER}	V_{CE}	I_B							
With external base-to-emitter resistance (R_{BE}) = 100 Ω		65			-	-10	-	10	μ A	
At $T_C = 150^\circ\text{C}$		65			-	-1	-	1	mA	
With base-emitter junction reverse-biased and external base-to-emitter resistance (R_{BE}) = 100 Ω	I_{CEX}	V_{CE}	I_B							
At $T_C = 150^\circ\text{C}$		-75	1.5		-	-10	-	-	μ A	
With base open	I_{CEO}	60		0	-	-100	-	100	μ A	
Emitter Cutoff Current	I_{EBO}		-5	0	-	-10	-	10	μ A	
DC Forward-Current Transfer Ratio	h_{FE}	2		1 ^a	20	100	20	100		
Collector-to-Emitter Sustaining Voltage (see Figs. 2 and 3):	$V_{CEO(sus)}$			0.1 ^a	0	-65 ^b	-	65 ^b	-	V
With base open				0.1 ^a		-80 ^b	-	80 ^b	-	
With external base-to-emitter resistance (R_{BE}) = 100 Ω	$V_{CER(sus)}$			0.1 ^a		-80 ^b	-	80 ^b	-	
Base-to-Emitter Voltage	V_{BE}	2		1 ^a	-	-1.5	-	1.5	V	
Collector-to-Emitter Saturation Voltage (measured 0.25 in (6.35 mm) from case) ^c	$V_{CE(sat)}$			1 ^a	0.1	-	-0.5	-	0.5	V
Magnitude of Common-Emitter, Small-Signal, Short-Circuit, Forward-Current Transfer Ratio ^d	$ h_{fe} $									
f = 4 MHz		-2		-0.1	2	15	-	-		
f = 200 kHz		2		0.1			5	20		
Common-Emitter, Small-Signal, Short-Circuit, Forward-Current Transfer Ratio (f = 1 kHz)	h_{fe}	2		0.1	25	-	25	-		

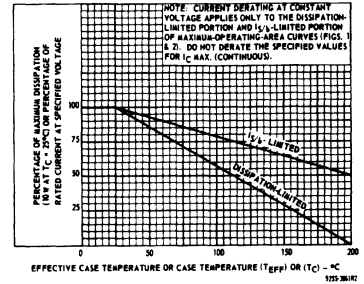


Fig. 1 - Dissipation derating curve for all types.

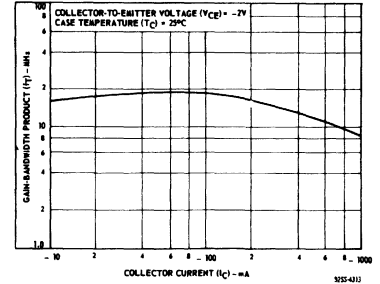


Fig. 2 - Typical gain-bandwidth product for 2N5781, 2N5782, & 2N5783.

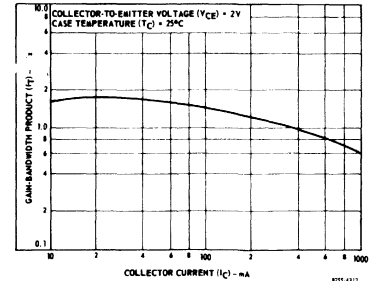


Fig. 3 - Typical gain-bandwidth product for 2N5784, 2N5785, & 2N5786.

2N5781-2N5786

ELECTRICAL CHARACTERISTICS, At Case Temperature (T_C) = 25°C unless otherwise specified

CHARACTERISTIC	SYMBOL	TEST CONDITIONS [†]				LIMITS				UNITS
		VOLTAGE V dc		CURRENT A dc		2N5781 p-n-p		2N5784 n-p-n		
		V _{CE}	V _{BE}	I _C	I _B	Min.	Max.	Min.	Max.	
Saturated Switching Time (V _{CC} = 30 V, I _{B1} = I _{B2}): Turn-on (t _d + t _r)	t _{ON}			-1 1	-0.1 0.1	-	0.5	-	5	μs
Turn-off (t _s + t _f)	t _{OFF}			-1 1	-0.1 0.1	-	2.5	-	15	
Thermal Resistance: Junction-to-case	R _{θJC}					-	17.5	-	17.5	°C/W
Junction-to-ambient	R _{θJA}					-	175	-	175	

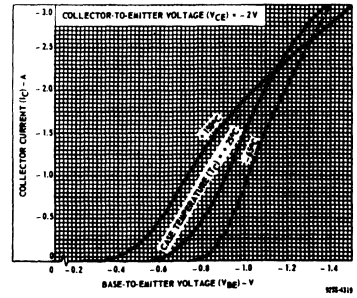


Fig. 4 - Typical transfer characteristics for types 2N5781, 2N5782, 2N5783.

ELECTRICAL CHARACTERISTICS, At Case Temperature (T_C) = 25°C unless otherwise specified

CHARACTERISTIC	SYMBOL	TEST CONDITIONS [†]				LIMITS				UNITS
		VOLTAGE V dc		CURRENT A dc		2N5782 p-n-p		2N5785 n-p-n		
		V _{CE}	V _{BE}	I _C	I _B	Min.	Max.	Min.	Max.	
Collector Cutoff Current: With external base-to-emitter resistance (R _{BE}) = 100 Ω At T _C = 150°C	I _{CER}	50				-	-10	-	10	μA
		50				-	-1	-	1	mA
With base-emitter junction reverse- biased and external base-to-emitter resistance (R _{BE}) = 100 Ω	I _{CEX}	-60	1.5			-	-10	-	-	μA
		60	-1.5			-	-	-	10	
At T _C = 150°C		-60	1.5			-	-1	-	-	μA
		60	-1.5			-	-	-	1	mA
With base open	I _{CEO}	35			0	-	-100	-	100	μA
Emitter Cutoff Current	I _{EBO}	-	-5	0		-	-10	-	10	μA
DC Forward-Current Transfer Ratio	h _{FE}	2		1.2 ^a		20	100	20	100	
		2		3.2 ^a		4	-	4	-	
Collector-to-Emitter Sustaining Voltage (see Figs. 2 and 3): With base open	V _{CEO(sus)}			0.1 ^a	0	-50 ^b	-	50 ^b	-	V
				0.1 ^a		-65 ^b	-	65 ^b	-	
With external base-to-emitter resistance (R _{BE}) = 100 Ω	V _{CER(sus)}			0.1 ^a		-65 ^b	-	65 ^b	-	V
Base-to-Emitter Voltage	V _{BE}	2		1.2 ^a		-	-1.5	-	1.5	V
Collector-to-Emitter Saturation Voltage (measured 0.25 in (6.35 mm) from case) ^c	V _{CE(sat)}			1.2 ^a	0.12	-	-0.75	-	0.75	V
Magnitude of Common-Emitter, Small-Signal, Short-Circuit, Forward-Current Transfer Ratio ^d f = 4 MHz	h _{fe}	-2		-0.1		2	15	-	-	
		2		0.1		-	-	5	20	
Common-Emitter, Small-Signal, Short-Circuit, Forward-Current Transfer Ratio (f = 1 kHz)	h _{fe}	2		0.1		25	-	25	-	
Saturated Switching Time (V _{CC} = 30 V, I _{B1} = I _{B2}): Turn-on (t _d + t _r)	t _{ON}			-1 1	-0.1 0.1	-	0.5	-	5	μs
				-1 1	-0.1 0.1	-	2.5	-	15	
Turn-off (t _s + t _f)	t _{OFF}			-1 1	-0.1 0.1	-	2.5	-	15	
Thermal Resistance: Junction-to-case	R _{θJC}					-	17.5	-	17.5	°C/W
Junction-to-ambient	R _{θJA}					-	175	-	175	

[†] In accordance with JEDEC registration data format JS-6 RDF-2.

^a Pulsed, pulse duration = 300 μs, duty factor = 1.8%.

^b CAUTION: Sustaining voltages V_{CEO(sus)} and V_{CER(sus)} MUST NOT be measured on a curve tracer.

[†] For p-n-p devices, voltage and current values are negative.

^c Lead resistance is critical in this test.

^d Measured at a frequency where |h_{fe}| is decreasing at approximately 6 dB per octave.

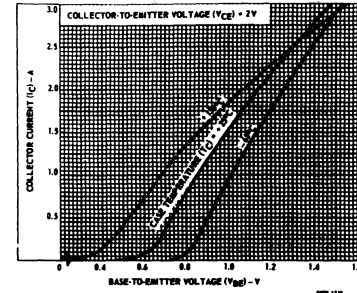


Fig. 5 - Typical transfer characteristics for types 2N5784, 2N5785, 2N5786.

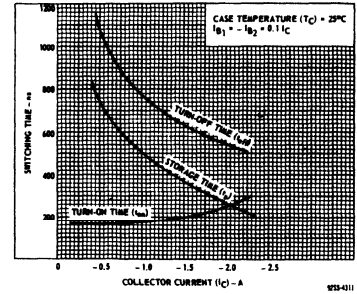


Fig. 6 - Typical saturated switching characteristics for types 2N5781, 2N5782, 2N5783.

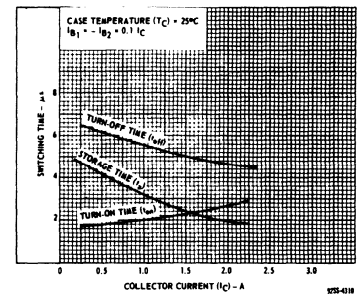


Fig. 7 - Typical saturated switching characteristics for types 2N5784, 2N5785, & 2N5786.

2N5781-2N5786

ELECTRICAL CHARACTERISTICS, At Case Temperature, $(T_C) = 25^\circ\text{C}$ unless otherwise specified

CHARACTERISTIC	SYMBOL	TEST CONDITIONS [†]				LIMITS				UNITS	
		VOLTAGE V dc		CURRENT A dc		2N5783 p-n-p		2N5786 n-p-n			
		V _{CE}	V _{BE}	I _C	I _B	Min.	Max.	Min.	Max.		
Collector Cutoff Current: With external base-to-emitter resistance (R_{BE}) = 100 Ω At $T_C = 150^\circ\text{C}$	I _{CER}	40				-	-10	-	10	μA	
At $T_C = 150^\circ\text{C}$		40				-	-1	-	1	mA	
With base-emitter junction reverse- biased and external base-to-emitter resistance (R_{BE}) = 100 Ω	I _{CER}	-45	1.5			-	-10	-	-	μA	
		45	-1.5			-	-	-	10	μA	
At $T_C = 150^\circ\text{C}$	I _{CER}	-45	1.5			-	-1	-	-	mA	
		45	-1.5			-	-	-	1	mA	
With base open	I _{CEO}	25				0	-	-100	-	100	μA
Emitter Cutoff Current	I _{EBO}		-3.5	0			-	-10	-	10	μA
DC Forward-Current Transfer Ratio	h _{FE}	2		1.6 ^a		20	100	20	100		
		2		3.2 ^a		4	-	4	-		
Collector-to-Emitter Sustaining Voltage (see Figs. 2 and 3): With base open	V _{CEO(sus)}			0.1 ^a	0	-40 ^b	-	40 ^b	-		V
	V _{CER(sus)}			0.1 ^a		-45 ^b	-	45 ^b	-		V
Base-to-Emitter Voltage	V _{BE}	2		1.6 ^a		-	-1.5	-	1.5		V
Collector-to-Emitter Saturation Voltage (measured 0.25 in (6.35 mm) from case) ^c	V _{CE(sat)}			1.6 ^a	0.16	-	-1	-	1		V
Magnitude of Common-Emitter, Small-Signal, Short-Circuit, Forward-Current Transfer Ratio ^d f = 4 MHz	h _{fe}										
Common-Emitter, Small-Signal, Short-Circuit, Forward-Current Transfer Ratio (f = 1 kHz)	h _{fe}	-2		-0.1	2	15	-	-	-		
		2		0.1	-	-	5	20	-	-	
Saturated Switching Time (V _{CC} = 30 V, I _{B1} = I _{B2}): Turn-on (t _d + t _r)	t _{ON}			-1	-0.1	-	0.5	-	-		μs
				1	0.1	-	-	-	5	-	
Turn-off (t _s + t _f)	t _{OFF}			-1	-0.1	-	2.5	-	-		μs
				1	0.1	-	-	-	15	-	
Thermal Resistance: Junction-to-case	R _{θJC}						17.5	-	17.5		$^\circ\text{C/W}$
Junction-to-ambient	R _{θJA}						-	175	-	175	$^\circ\text{C/W}$

[†] In accordance with JEDEC registration data format JS-6 RDF-2.

^a Pulsed, pulse duration = 300 μs , duty factor = 1.8%.

^b CAUTION: Sustaining voltages V_{CEO(sus)} and V_{CER(sus)} MUST NOT be measured on a curve tracer.

[†] For p-n-p devices, voltage and current values are negative.

^c Lead resistance is critical in this test.

^d Measured at a frequency where |h_{fe}| is decreasing at approximately 6 dB per octave.

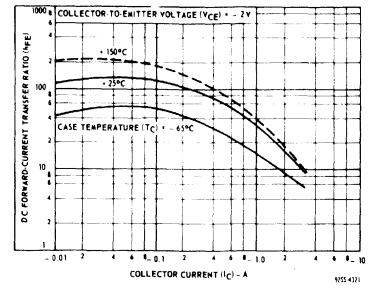


Fig. 8 - Typical dc-beta characteristics for type 2N5781.

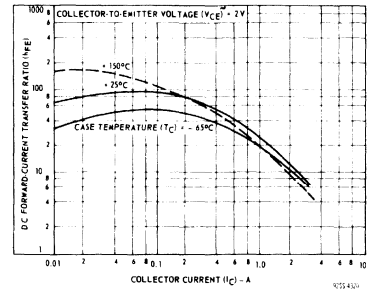


Fig. 9 - Typical dc-beta characteristics for type 2N5784.

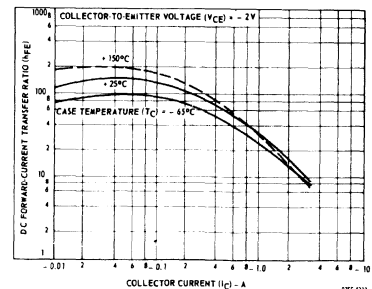


Fig. 10 - Typical dc-beta characteristics for type 2N5782.

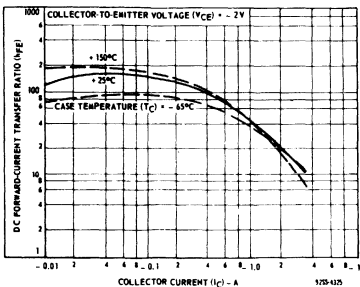


Fig. 11 - Typical dc-beta characteristics for type 2N5783.

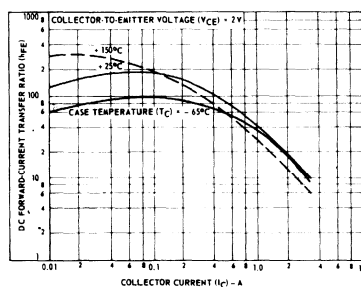


Fig. 12 - Typical dc-beta characteristics for type 2N5786.

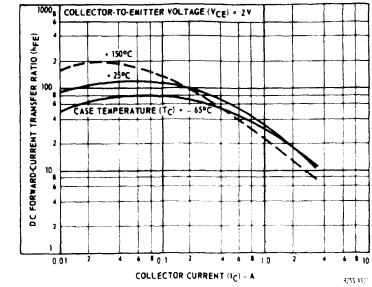


Fig. 13 - Typical dc-beta characteristics for type 2N5785.

2N5781-2N5786

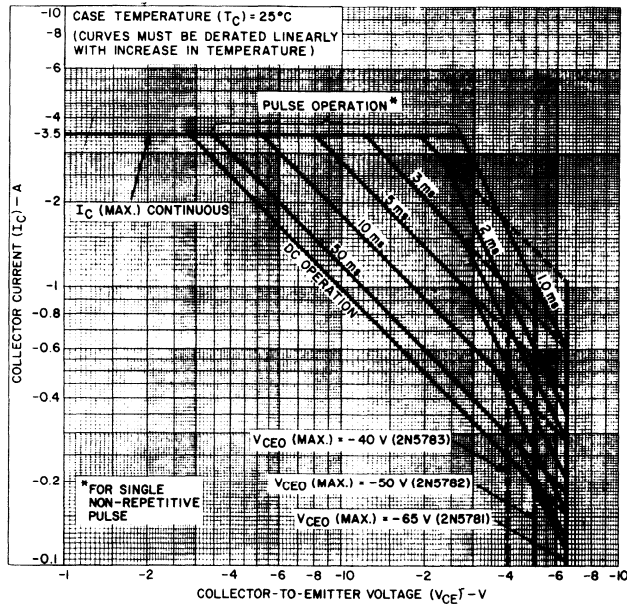


Fig. 14 - Maximum operating areas for types 2N5781, 2N5782, and 2N5783.

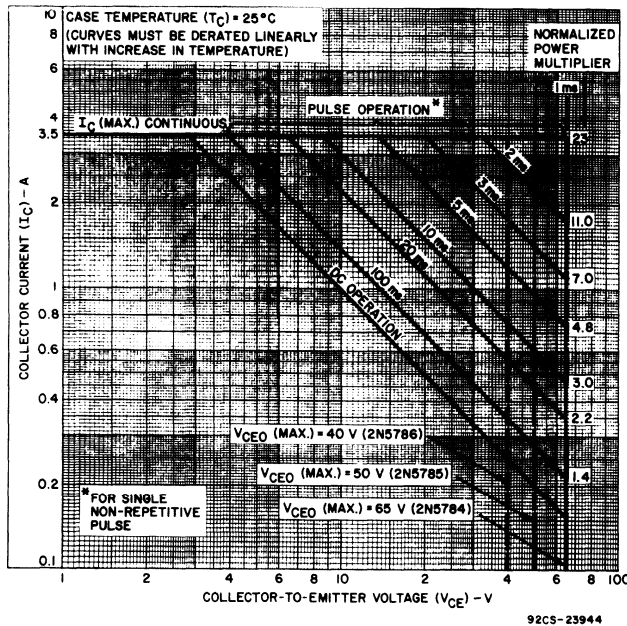


Fig. 15 - Maximum operating areas for types 2N5784, 2N5785, and 2N5786.

2N5838-2N5840

High-Voltage, High-Power Silicon N-P-N Power Transistor

For Switching and Linear Applications in Military, Industrial and Commercial Equipment

RCA 2N5838, 2N5839 and 2N5840** are epitaxial silicon n-p-n power transistors utilizing a multiple-emitter-site structure. These devices employ the popular JEDEC TO-3 package; they differ mainly in voltage, current-gain, and $V_{CE}(sat)$ ratings.

Featuring high breakdown voltage ratings and low-saturation voltage values, the 2N5838, 2N5839 and 2N5840

are especially suitable for use in inverters, deflection circuits, switching regulators, high-voltage bridge amplifiers, ignition circuits, and other high-voltage switching applications.

** Formerly RCA Dev. types TA7513, TA7530, and TA7420 respectively.

Features:

- Maximum safe-area-of-operation curves
- Low saturation voltages
- High voltage ratings

$$V_{CE}(sus) = 375 \text{ V (2N5840)}$$

$$300 \text{ V (2N5839)}$$

$$275 \text{ V (2N5838)}$$

- High dissipation rating
- $$P_T = 100 \text{ W}$$

MAXIMUM RATINGS, Absolute-Maximum Values:

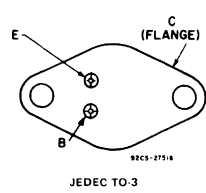
	2N5838	2N5839	2N5840	
*COLLECTOR-TO-BASE VOLTAGE, V_{CBO}	275	300	375	V
COLLECTOR-TO-EMITTER SUSTAINING VOLTAGE:				
* With base open, $V_{CE0}(sus)$	250	275	350	V
With reverse bias (V_{BE}) of -1.5 V, $V_{CE}(sus)$ ▲	275	300	375	V
With external base-to-emitter resistance (R_{BE}) $\leq 50 \Omega$, $V_{CE}(sus)$	275	300	375	V
*EMITTER-TO-BASE VOLTAGE, V_{EBO}	6	6	6	V
*COLLECTOR CURRENT, I_C				
Continuous	3	3	3	A
Peak	5	5	5	A
*CONTINUOUS BASE CURRENT, I_B	1.5	1.5	1.5	A

***TRANSISTOR DISSIPATION, P_T :**

At case temperature up to 25°C and V_{CE} up to 40 V	100	100	100	W
At case temperatures up to 25°C and V_{CE} above 40 V	See Fig. 5			
At case temperatures above 25°C and V_{CE} above 40 V	See Figs. 1 & 5			
*TEMPERATURE RANGE: Storage & Operating (Junction)	-65	+200		°C
*PIN TEMPERATURE (During Soldering): At distances $\geq 1/32$ in. (0.8 mm) from case for 10 s max	230			°C

▲ In accordance with JEDEC registration data format (JS-6, RDP-1).
 Shown as $V_{CE}(sus)$ in JEDEC Registration Data.

TERMINAL DESIGNATIONS



ELECTRICAL CHARACTERISTICS, Case Temperature (T_C) = 25°C

CHARACTERISTIC	SYMBOL	TEST CONDITIONS				LIMITS						UNITS	
		VOLTAGE		CURRENT		2N5838		2N5839		2N5840			
		V_{dc}		I_{dc}	I_B	Min.	Max.	Min.	Max.	Min.	Max.		
Collector-Cutoff Current	I_{CEO}	200				2				2		mA	
With base open		250						2					
With base-emitter junction reverse biased		265	-1.5			5			2				
With base-emitter junction reverse biased, $T_C = 100^\circ\text{C}$	I_{CEV}	265	1.5			8		5		5		mA	
With base-emitter junction reverse biased, $T_C = 100^\circ\text{C}$		290	1.5										
With base-emitter junction reverse biased, $T_C = 100^\circ\text{C}$		360	1.5										
Emitter Cutoff Current	I_{EBO}			-6		1		1		1		mA	
Collector to Emitter Sustaining Voltage	$V_{CE0}(sus)$ ^a			0.2		250 ^b		275 ^b		350 ^b			V
With base open													
With base-emitter junction reverse biased	$V_{CEX}(sus)$ ^a		1.5	0.1		275 ^b		300 ^b		375 ^b			
With external base-to-emitter resistance (R_{BE}) $\leq 50 \Omega$	$V_{CER}(sus)$ ^a			0.2		275 ^b		300 ^b		375 ^b			
Emitter-to-Base Voltage	V_{EBO}					6		6		6		V	
DC Forward-Current Transfer Ratio	h_{FE}	5		0.5		20		20		20			
Base-to-Emitter Saturation Voltage	$V_{BE}(sat)$	3		2		2		10		50			
Collector to Emitter Saturation Voltage	$V_{CE}(sat)$	2		3		2		2		2		V	
Output Capacitance	C_{ob0}					150		150		150			
Magnitude of Common Emitter Small Signal Short Circuit Forward Current Transfer Ratio at 1 MHz	$ h_{fe} $					5		5		5			
Forward-Bias, Second-Breakdown Collector Current: $t = 1 \text{ s}$, nonrepetitive	$I_{S/B}$	40				2.5		2.5		2.5		A	
Second Breakdown Energy (With base reverse biased, $R_B = 50 \Omega$, $L = 100 \mu\text{H}$)	$E_{S/B}$	4				0.45		0.45		0.45			
Thermal Resistance (Junction-to-Case)	$R_{\theta JC}$	10				1.75		1.75		1.75			

^a In accordance with JEDEC registration data format (JS-6 RDP-1).
^b Pulsed; pulse duration = 350 μs . Duty factor $\leq 2\%$.

^c CAUTION: The sustaining voltages $V_{CE0}(sus)$, $V_{CEX}(sus)$ and $V_{CER}(sus)$, MUST NOT be measured on a curve tracer.

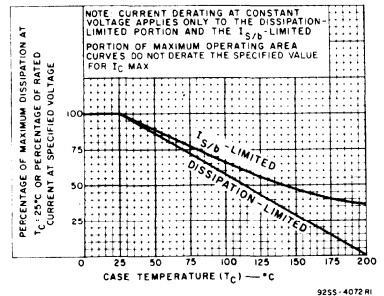


Fig. 1 - Derating curves for all types.

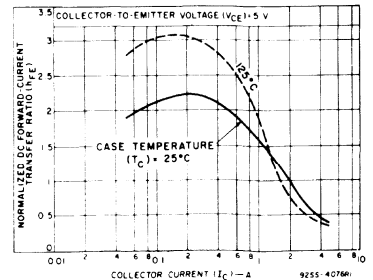


Fig. 2 - Typical normalized dc beta characteristics for all types.

2N5838-2N5840

SWITCHING-TIME CHARACTERISTICS, At Case Temperature (T_C) = 25°C

CHARACTERISTIC	SYMBOL	TEST CONDITIONS			LIMITS				UNITS		
		VOLTAGE V dc	CURRENT A dc		2N5838		2N5839			2N5840	
			V _{CC}	I _C	I _B *	Max.	Typ.	Max.		Typ.	Max.
Switching Times:											
Delay	t _d	200	2 3	0.2 0.375	- 0.06	-	0.07	-	0.07	μs	
Rise	t _r	200	2 3	0.2 0.375	- 1.5	0.8	1.5	0.6	1.75		
Storage	t _s	200	2 3	0.2 0.375	3.0	1.0	3.75	1.75	3.0		
Fall	t _f	200	2	0.2	-	1.5	0.35	1.5	0.35		
			3	0.375	1.5	0.4	-	-	-		-

* In accordance with JEDEC registration data format (JS-6 RDF-1). * I_{B1} = I_{B2} = value shown.

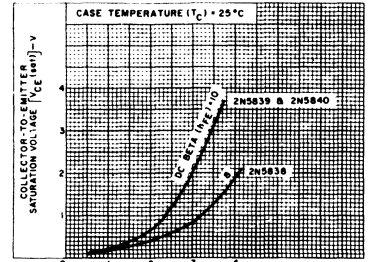


Fig. 3 - Typical saturation voltage characteristics for all types.

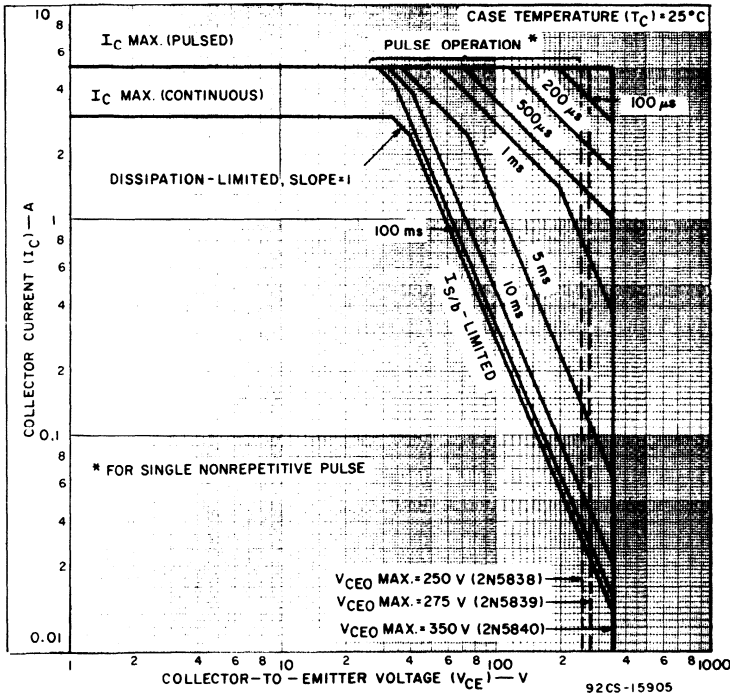


Fig. 5 - Maximum operating areas for all types.

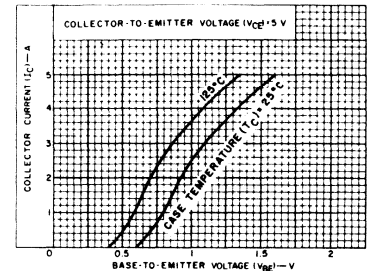


Fig. 4 - Typical transfer characteristics for all types.

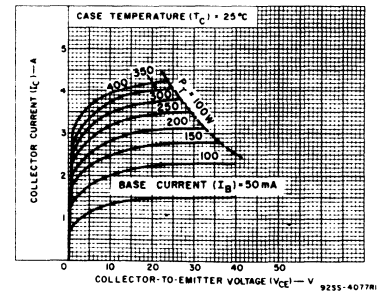


Fig. 6 - Typical output characteristics for all types.

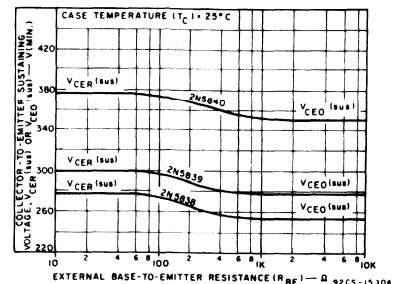


Fig. 7 - Collector-to-emitter sustaining voltage characteristics for all types.

2N5838-2N5840

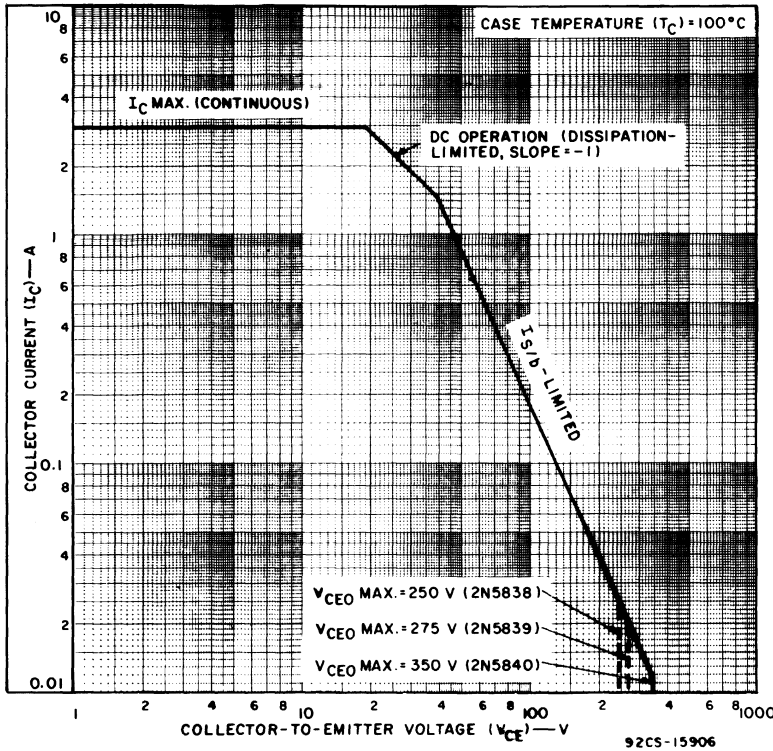


Fig. 8 - Maximum operating areas for all types.

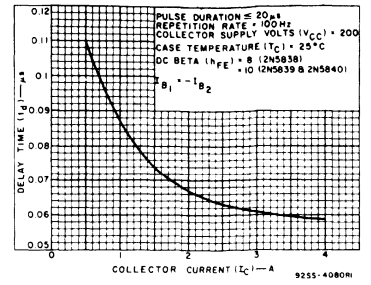


Fig. 9 - Typical delay-time characteristic for all types.

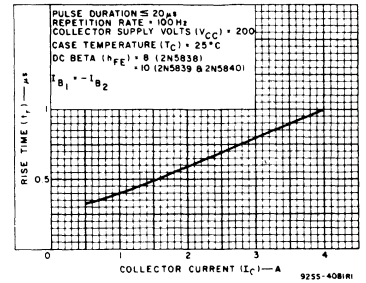


Fig. 10 - Typical rise-time characteristic for all types.

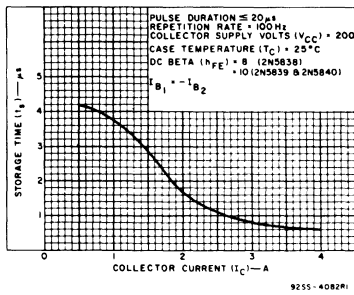


Fig. 11 - Typical storage-time characteristic for all types.

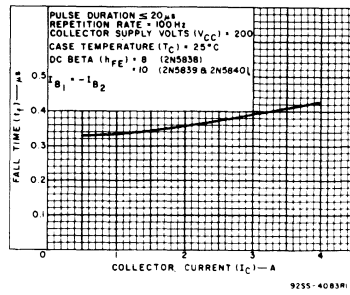


Fig. 12 - Typical fall-time characteristic for all types.

2N5869, 2N5870

Silicon N-P-N Epitaxial-Base High-Power Transistors

Rugged Devices, Broadly Applicable For Industrial and Commercial Use

The RCA-2N5869 and 2N5870 are epitaxial-base silicon n-p-n transistors featuring high gain at high current. These devices have a dissipation capability of 87.5 watts at case temperatures up to 25°C.

They differ in voltage ratings and in the currents at which the parameters are controlled.

Both of these devices are supplied in the steel JEDEC TO-204MA hermetic package.

Features:

- High dissipation capability
- Low saturation voltages.
- Maximum safe-areas-of-operation curves
- Hermetically sealed JEDEC TO-204MA package
- High gain at high current
- Thermal-cycling rating curve

Applications:

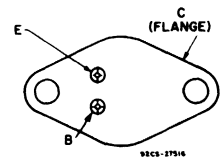
- Series and shunt regulators
- High-fidelity amplifiers
- Power-switching circuits
- Solenoid drivers

MAXIMUM RATINGS, Absolute-Maximum Values:

	2N5869	2N5870	
* V _{CEO}	60	80	V
* V _{CBO}	60	80	V
* V _{EBO}	5	5	V
* I _C	5	5	A
* I _{CM}	10	10	A
* I _B	2	2	A
* P _T	87.5	87.5	W
At T _C ≤ 25°C			
At T _C > 25°C	derate linearly	0.5	W/°C
* T _{stg} , T _J	-65 to 200		°C
* T _L	250		°C
At distance 1/16 in. (1.58 mm) from case for 10 s			

* In accordance with JEDEC registration data.

TERMINAL DESIGNATIONS



JEDEC TO-204MA

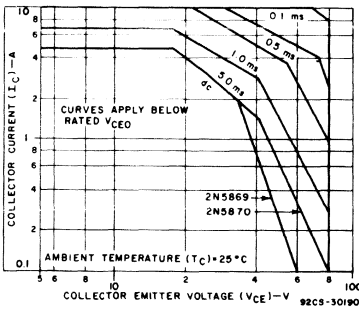


Fig. 1 - Maximum operating areas.

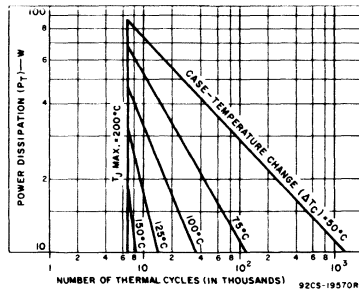


Fig. 2 - Thermal-cycling rating chart.

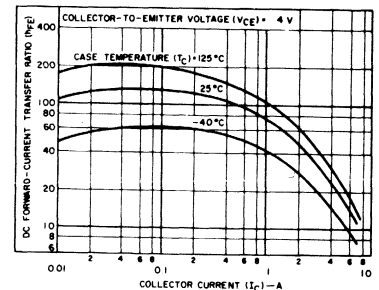


Fig. 3 - Typical dc beta characteristics for both types.

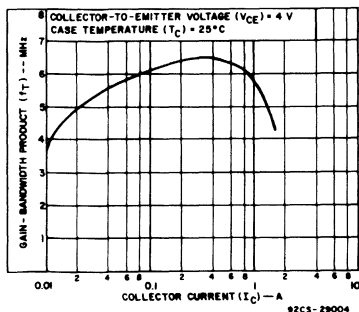


Fig. 4 - Typical gain-bandwidth characteristics for both types.

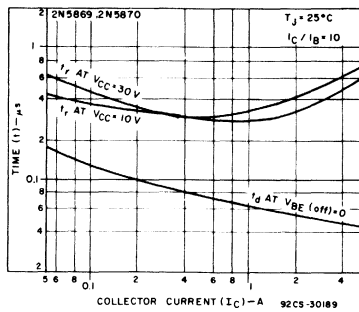


Fig. 5 - Turn-on-time characteristics.

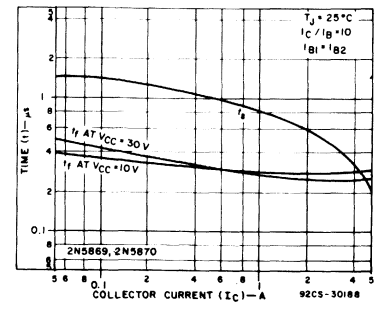


Fig. 6 - Turn-off-time characteristics.

2N5869, 2N5870

ELECTRICAL CHARACTERISTICS, at Case Temperature
 $T_C = 25^\circ\text{C}$ Unless Otherwise Specified

CHARACTERISTIC	TEST CONDITIONS				LIMITS				UNIT
	VOLTAGE V dc		CURRENT A dc		2N5869		2N5870		
	V_{CE}	V_{BE}	I_C	I_B	MIN.	MAX.	MIN.	MAX.	
* I_{CEX}	60 80	1.5 1.5	- -	- -	- -	0.1 -	- -	- 0.1	mA
$T_C = 150^\circ\text{C}$	60 80	1.5 1.5	- -	- -	- -	2 -	- 2		
* I_{CEO}	30 40	- -	- -	0 0	- -	0.5 -	- -	- 0.5	mA
* I_{CBO} $I_E = 0$	60 [●] 80 [●]	- -	- -	- -	- -	0.1 -	- 0.1		
* I_{EBO}	-	-5	0	-	-	1	-	1	mA
* $V_{CEO(sus)}^b$	-	-	0.1	0	60	-	80	-	
* h_{FE}^a	4 4 4	- - -	0.3 1.5 5	- - -	35 20 4	- 100 -	35 20 4	- 100 -	
* V_{BE}^a	4	-	1.5	-	-	1.5	-	1.5	
* $V_{BE(sat)}^a$	-	-	5	1.25	-	2.5	-	2.5	V
* $V_{CE(sat)}^a$	-	-	2 5	0.2 1.25	-	1 2	-	1 2	
* f_T $f = 1\text{ MHz}$	10	-	0.25	-	4	-	4	-	MHz
* h_{fe} $f = 1.0\text{ kHz}$	4	-	0.25	-	20	-	20	-	
* C_{ob} $V_{CB} = 10\text{ V}$ $f = 1\text{ kHz}$	-	-	-	-	-	150	-	150	pF
* t_r	-	-	1.5	0.15 ^c	-	0.7	-	0.7	
* t_s $V_{CC} = 30\text{ V}$	-	-	1.5	0.15 ^c	-	1	-	1	μs
* t_f	-	-	1.5	0.15 ^c	-	0.8	-	0.8	
$R_{\theta JC}$	-	-	-	-	-	2	-	2	$^\circ\text{C/W}$

- * In accordance with JEDEC registration data.
- V_{CB}
- ^a Pulsed; pulse width $\leq 300\ \mu\text{s}$, duty factor $\leq 2\%$.
- ^b CAUTION: Sustaining voltage, $V_{CE0(sus)}$, *MUST NOT* be measured on a curve tracer.
- ^c $I_{B1} = -I_{B2}$

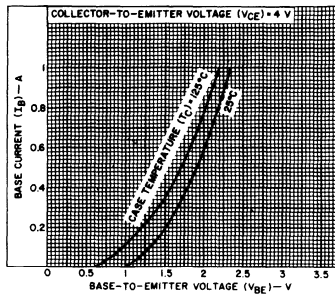


Fig. 7 - Typical input characteristics for both types.

2N5871, 2N5872, 2N5873, 2N5874

Silicon N-P-N and P-N-P Epitaxial-Base High-Power Transistors

Rugged Devices, Broadly Applicable For Industrial and Commercial Use

The RCA-2N5871 and 2N5872 are epitaxial-base silicon p-n-p transistors featuring high gain at high current. The RCA-2N5873 and 2N5874 are epitaxial-base silicon n-p-n transistors. They may be used as complements to 2N5871 and 2N5872, respectively. These

devices have a dissipation capability of 115 watts at case temperature up to 25°C.

They differ in voltage ratings and in the currents at which the parameters are controlled. All are supplied in the steel JEDEC TO-204MA hermetic package.

Features:

- High dissipation capability
- Low saturation voltages
- Maximum safe-areas-of-operation curves
- Hermetically sealed JEDEC TO-3/TO-204MA package
- High gain at high current
- Thermal-cycling rating curve

Applications:

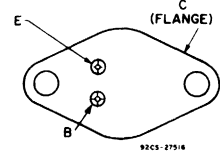
- Series and shunt regulators
- High-fidelity amplifiers
- Power-switching circuits
- Solenoid drivers

MAXIMUM RATINGS, Absolute-Maximum Values:

	2N5871* 2N5873	2N5872* 2N5874	
* V _{CEO}	60	80	V
* V _{CBO}	60	80	V
* V _{EBO}	5	5	V
* I _C	7	7	A
* I _{CM}	15	15	A
* I _B	2	2	A
* P _T			
At T _C ≤ 25°C	115	115	W
At T _C > 25°C derate linearly	0.658		W/°C
* T _L			
At distance 1/16 in. (1.58 mm) from case for 10 s	250		°C
* T _J , T _{stg}	-65 to 200		°C

* In accordance with JEDEC registration data.
 • For p-n-p devices, voltage and current values are negative.

TERMINAL DESIGNATIONS



JEDEC TO-204MA

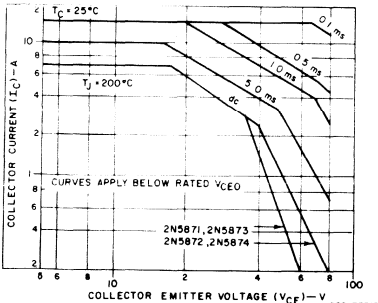


Fig. 1 - Maximum operating areas for all types.

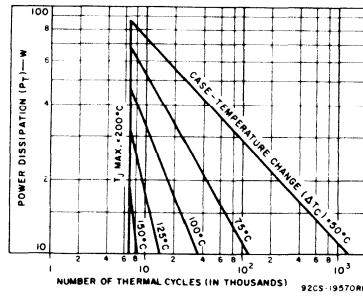


Fig. 2 - Thermal-cycling rating chart.

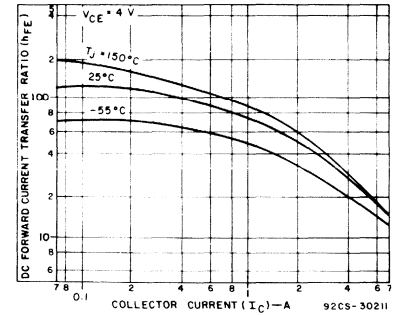


Fig. 3 - Typical dc beta characteristics for 2N5871 and 2N5872.

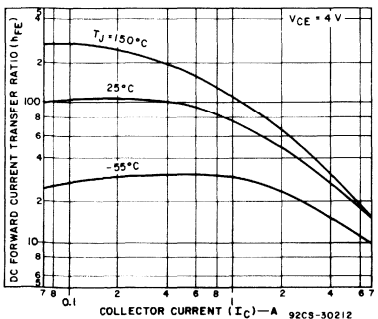


Fig. 4 - Typical dc beta characteristics for 2N5873 and 2N5874.

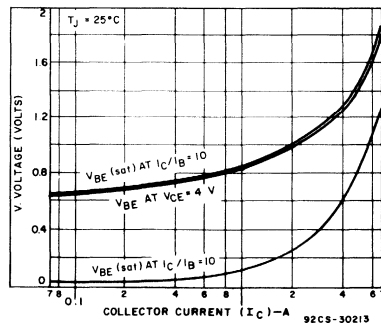


Fig. 5 - Typical voltage characteristics for 2N5871 and 2N5872.

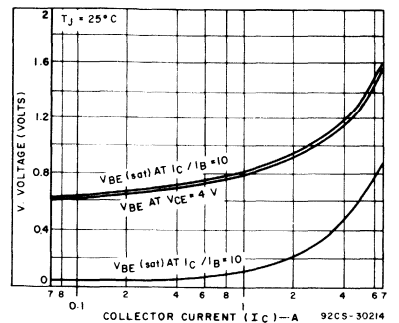


Fig. 6 - Typical voltage characteristics for 2N5873 and 2N5874.

2N5871, 2N5872, 2N5873, 2N5874

ELECTRICAL CHARACTERISTICS, at Case Temperature
 $T_C = 25^\circ\text{C}$ Unless Otherwise Specified

CHARACTERISTIC	TEST CONDITIONS				LIMITS				UNIT	
	VOLTAGE		CURRENT		2N5871 [•] 2N5873		2N5872 [•] 2N5874			
	V dc	V dc	A dc	A dc	MIN.	MAX.	MIN.	MAX.		
* I_{CEX}	60	1.5	-	-	-	0.25	-	-	mA	
	80	1.5	-	-	-	-	-	0.25		
$T_C = 150^\circ\text{C}$	60	1.5	-	-	-	2	-	-		
	80	1.5	-	-	-	-	-	2		
* I_{CEO}	30	-	-	0	-	0.5	-	-	mA	
	40	-	-	0	-	-	-	0.5		
* I_{CBO} $I_E = 0$	60 ^c	-	-	-	-	0.25	-	-	mA	
	80 ^c	-	-	-	-	-	-	0.25		
* I_{EBO}	-	-5	0	-	-	1	-	1	mA	
* $V_{CE0(sus)}^b$	-	-	0.1	0	60	-	80	-	V	
* h_{FE}^a	4	-	0.5	-	35	-	35	-		
	4	-	2.5	-	20	100	20	100		
	4	-	7.0	-	4	-	4	-		
* V_{BE}^a	4	-	2.5	-	-	1.5	-	1.5	V	
* $V_{BE(sat)}^a$	-	-	7	1.75	-	2.5	-	2.5	V	
* $V_{CE(sat)}^a$	-	-	4	0.4	-	1	-	1	V	
	-	-	7	1.75	-	2	-	2		
* f_T $f = 1\text{ MHz}$	10	-	0.25	-	4	-	4	-	MHz	
* h_{fe} $f = 1.0\text{ kHz}$	4	-	0.5	-	20	-	20	-		
* C_{ob} $f = 1\text{ MHz}$	2N5871-72 2N5873-74	10 ^c	-	-	-	300 250	-	300 250	pF	
* t_r	$V_{CC} = 30\text{ V}$	-	-	2.5	0.25 ^d	-	0.7	-	0.7	μs
* t_s		-	-	2.5	0.25 ^d	-	1	-	1	μs
* t_f		-	-	2.5	0.25 ^d	-	0.8	-	0.8	μs
* $R_{\theta JC}$	-	-	-	-	-	1.52	-	1.52	$^\circ\text{C/W}$	

- For p-n-p devices, voltage and current values are negative.
- * In accordance with JEDEC registration data.
- ^a Pulsed; pulse width $\leq 300\ \mu\text{s}$, duty factor $\leq 2\%$.
- ^b CAUTION: Sustaining voltage, $V_{CE0(sus)}$, *MUST NOT* be measured on a curve tracer.
- ^c V_{CB}
- ^d $I_{B1} = -I_{B2}$

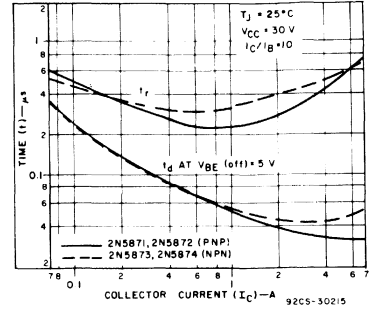


Fig. 7 - Typical turn-on-time for all types.

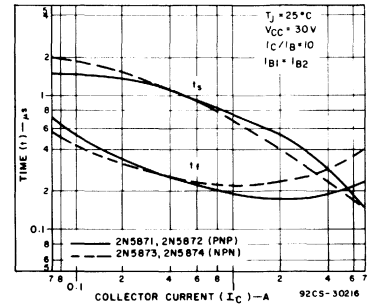


Fig. 8 - Typical turn-off-time for all types.

2N5875, 2N5876, 2N5877, 2N5878

Silicon N-P-N and P-N-P Epitaxial-Base High-Power Transistors

Rugged Devices, Broadly Applicable
For Industrial and Commercial Use

The RCA-2N5875 and 2N5876 are epitaxial-base silicon p-n-p transistors featuring high gain at high current. The RCA-2N5877 and 2N5878 are epitaxial-base silicon n-p-n transistors. They may be used as complements to 2N5875 and 2N5876, respectively. These devices have a compability of 150 watts at case temperatures up to 25°C.

They differ in voltage ratings and in currents at which the parameters are controlled. All are supplied in the steel JEDEC TO-204MA hermetic package.

Features:

- High dissipation capability
- Low saturation voltages
- Maximum safe-areas-of-operation curves
- Hermetically sealed JEDEC TO-3/TO-204MA package
- High gain at high current
- Thermal-cycling rating curve

Applications:

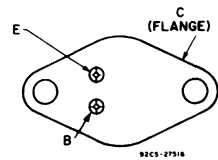
- Series and shunt regulators
- High-fidelity amplifiers
- Power-switching circuits
- Solenoid drivers

MAXIMUM RATINGS, Absolute Values:

	2N5875* 2N5877	2N5876* 2N5878	
* V _{CEO}	60	80	V
* V _{CBO}	60	80	V
* V _{EBO}	5	5	V
* I _C	10	10	A
* I _{CM}	20	20	A
* I _B	4	4	A
* P _T			
At T _C ≤ 25°C	150	150	W
At T _C > 25°C	derate linearly	0.857	W/°C
* T _J , T _{stg}		-65 to 200	°C
* T _L			
At 1/16 in. (1.58 mm) from case for 10 s		250	°C

*In accordance with JEDEC registration data.
• For p-n-p devices, voltage & current values are negative.

TERMINAL DESIGNATIONS



JEDEC TO-204MA

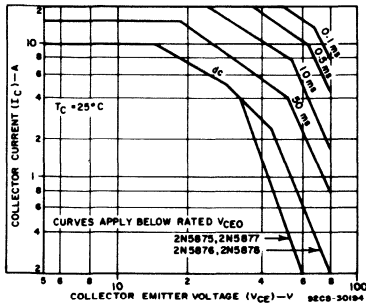


Fig. 1 - Collector-emitter voltage (V_{CE})-I_C.

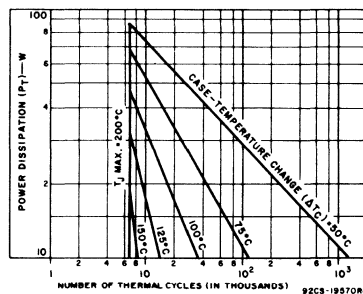


Fig. 2 - Thermal-cycling rating chart.

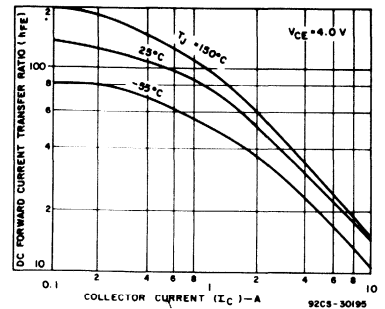


Fig. 3 - Typical dc beta characteristics for 2N5875 and 2N5876.

2N5875, 2N5876, 2N5877, 2N5878

ELECTRICAL CHARACTERISTICS, at Case Temperature $T_C = 25^\circ\text{C}$
Unless Otherwise Specified

CHARACTERISTIC	TEST CONDITIONS				LIMITS				UNITS
	VOLTAGE		CURRENT		2N5875 [®] 2N5877		2N5876 [®] 2N5878		
	V dc	A dc	MIN.	MAX.	MIN.	MAX.	MIN.	MAX.	
I_{CEX}	60	1.5	—	—	—	0.5	—	—	mA
	80	1.5	—	—	—	—	—	0.5	
$T_C = 150^\circ\text{C}$	60	1.5	—	—	—	5	—	—	mA
	80	1.5	—	—	—	—	—	5	
I_{CEO}	30	—	—	0	—	1	—	—	mA
	40	—	—	0	—	—	—	1	
I_{CBO} $I_E = 0$	60 ^c	—	—	—	—	0.5	—	—	mA
	80 ^c	—	—	—	—	—	—	0.5	
I_{EBO} $I_E = 0$	—	-5	—	—	—	1	—	1	mA
	—	—	—	—	—	—	—	—	
$V_{CE0(sus)}^b$	—	—	0.2	0	60	—	80	—	V
h_{FE}^a	4	—	1	—	35	—	35	—	
	4	—	4	—	20	100	20	100	
	4	—	10	—	4	—	4	—	
V_{BE}^a	4	—	4	—	—	1.5	—	1.5	V
$V_{BE(sat)}^a$	—	—	10	—	—	2.5	—	2.5	V
$V_{CE(sat)}^a$	—	—	5	0.5	—	1	—	1	V
	—	—	10	2.5	—	3	—	3	
f_T^c $f = 1\text{ MHz}$	10	—	0.5	—	4	—	4	—	MHz
h_{fe} $f = 1\text{ kHz}$	4	—	1	—	20	—	20	—	
C_{ob} $V_{CB} = 10\text{ V}$ 2N5875-76 $f = 1\text{ MHz}$ 2N5877-78	—	—	—	—	—	500	—	500	pF
	—	—	—	—	—	300	—	300	
t_r	—	—	4	0.4 ^d	—	0.7	—	0.7	μs
t_s $V_{CC} = 30\text{ V}$	—	—	4	0.4 ^d	—	1.0	—	1.0	μs
	—	—	4	0.4 ^d	—	0.8	—	0.8	
$R_{\theta JC}$	—	—	—	—	—	1.17	—	1.17	$^\circ\text{C/W}$

* In accordance with JEDEC registration data.
^a Pulsed; pulse width $\leq 300\ \mu\text{s}$, duty cycle $\leq 2\%$.
^b $V_{CE0(sus)}$ **MUST NOT** be measured on a curve tracer.
^c V_{CB}
^d $I_{B1} = -I_{B2}$

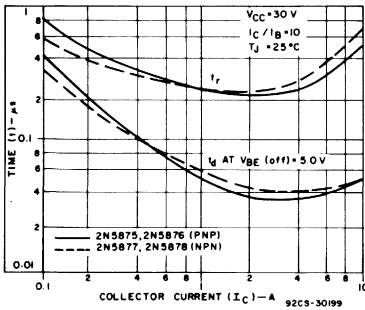


Fig. 7 - Typical turn-on-time for all types.

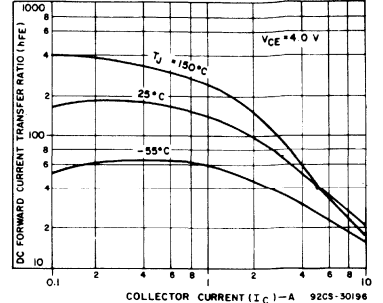


Fig. 4 - Typical dc beta characteristics for 2N5877 and 2N5878.

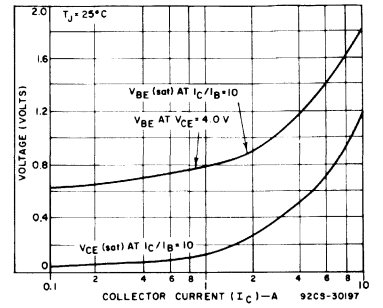


Fig. 5 - Typical voltages for 2N5875 and 2N5876.

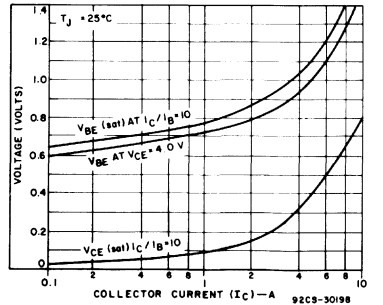


Fig. 6 - Typical voltages for 2N5877 and 2N5878.

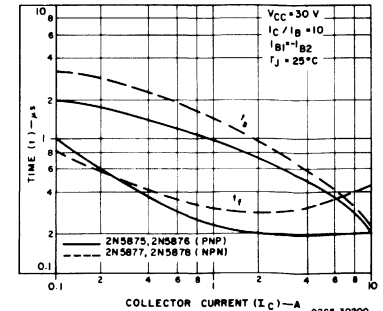


Fig. 8 - Typical turn-off-time for all types.

2N5879, 2N5880, 2N5881, 2N5882

Silicon N-P-N and P-N-P Epitaxial-Base High-Power Transistors

Rugged Devices, Broadly Applicable For Industrial and Commercial Use

The RCA-2N5879 and 2N5880 are epitaxial-base silicon p-n-p transistors featuring high gain at high current. The RCA-2N5881 and 2N5882 are epitaxial-base silicon n-p-n transistors. They may be used as complements to 2N5879 and 2N5880, respectively. These devices have a dissipation capability of 160 watts at case temperatures up to 25°C.

They differ in voltage ratings and in the currents at which the parameters are controlled. All are supplied in the steel JEDEC TO-204MA hermetic package.

Features:

- High dissipation capability
- Low saturation voltages
- Maximum safe-area-of-operation curves
- Hermetically sealed JEDEC TO-3/TO-204MA package
- High gain at high current
- Thermal-cycling rating curve

Applications:

- Series and shunt regulators
- High-fidelity amplifiers
- Power-switching circuits
- Solenoid drivers

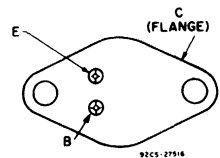
MAXIMUM RATINGS, Absolute-Maximum Values:

	2N5879* 2N5881	2N5880* 2N5882	
* V _{CEO}	60	80	V
* V _{CBO}	60	80	V
* V _{EBO}	5	5	V
* I _C	15	15	A
* I _{CM}	30	30	A
* I _B	5	5	A
* P _T			
At T _C ≤ 25°C	160	160	W
At T _C > 25°C	derate linearly		W/°C
* T _J , T _{stg}	-65 to 200		°C
* T _L			
At 1/16 in. (1.58 mm) from case for 10 s	250		°C

* In accordance with JEDEC registration data.

• For p-n-p devices, voltage and current values are negative.

TERMINAL DESIGNATIONS



JEDEC TO-204MA

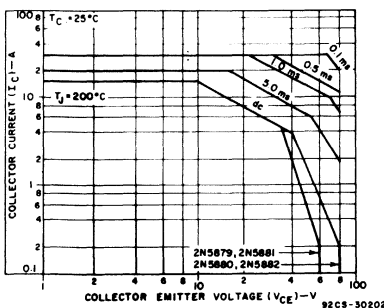


Fig. 1 - Maximum operating areas for all types.

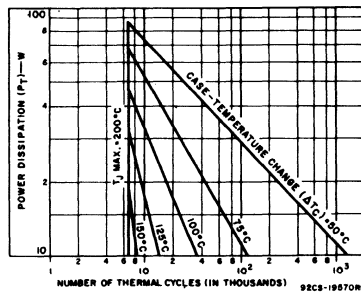


Fig. 2 - Thermal-cycling rating chart.

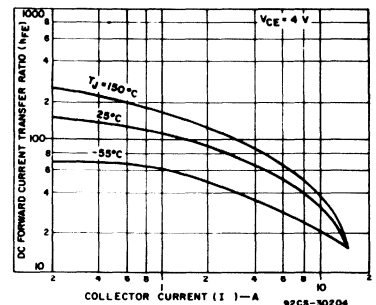


Fig. 3 - Typical dc beta characteristics for 2N5879 and 2N5880.

2N5879, 2N5880, 2N5881, 2N5882

ELECTRICAL CHARACTERISTICS, At Case Temperature
 $T_C = 25^\circ\text{C}$ Unless Otherwise Specified

CHARACTERISTIC	TEST CONDITIONS				LIMITS				UNITS
	VOLTAGE V dc		CURRENT A dc		2N5879 ^a 2N5881		2N5880 ^a 2N5882		
	V _{CE}	V _{BE}	I _C	I _B	Min.	Max.	Min.	Max.	
* I _{CEX}	60	1.5	—	—	—	0.5	—	—	mA
	80	1.5	—	—	—	—	0.5		
$T_C = 150^\circ\text{C}$	60	1.5	—	—	—	5	—	—	mA
	80	1.5	—	—	—	—	5		
* I _{CEO}	30	—	—	0	—	1	—	—	mA
	40	—	—	0	—	—	—	1	
* I _{CBO} I _E = 0	60 ^c	—	—	—	—	0.5	—	—	mA
	80 ^c	—	—	—	—	—	—	0.5	
* I _{EBO}	—	-5	0	—	—	1	—	1	mA
* V _{CEO(sus)} ^b	—	—	0.2	0	60	—	80	—	
* h _{FE} ^a	4	—	2	—	35	—	35	—	
	4	—	6	—	20	100	20	100	
	4	—	15	—	4	—	4	—	
* V _{BE} ^a	4	—	6	—	—	1.5	—	1.5	V
* V _{BE(sat)} ^a	—	—	15	3.75	—	2.5	—	2.5	
* V _{CE(sat)} ^a	—	—	7	0.7	—	1	—	1	V
	—	—	15	3.75	—	4	—	4	
* f _T , f = 1 MHz	10	—	1	—	4	—	4	—	MHz
* h _{fe} , f = 1 kHz	4	—	2	—	20	—	20	—	
* C _{ob} , f = 1 MHz									pF
2N5879-80	10 ^c	—	—	—	—	600	—	600	
2N5881-82	10 ^c	—	—	—	—	400	—	400	
* t _r	—	—	6	0.6 ^d	—	0.7	—	0.7	μs
* t _s V _{CC} = 30 V	—	—	6	0.6 ^d	—	1	—	1	
* t _f	—	—	6	0.6 ^d	—	0.8	—	0.8	μs
R _{θJC}	—	—	—	—	—	1.1	—	1.1	

*In accordance with JEDEC registration data.

^aFor p-n-p devices, voltage and current values are negative.

^dPulsed; pulse duration ≤ 300 μs, duty factor = 2%.

^bCAUTION: Sustaining voltage, V_{CEO}(sus), MUST NOT be measured on a curve tracer.

$$\frac{V_{CE}}{I_{B1}} = I_{B2}$$

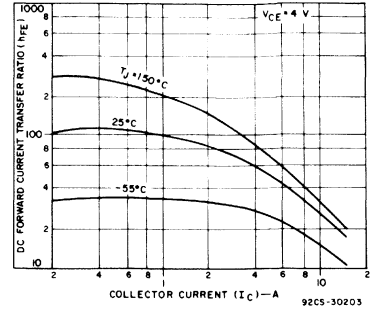


Fig. 4 — Typical dc beta characteristics for 2N5881 and 2N5882.

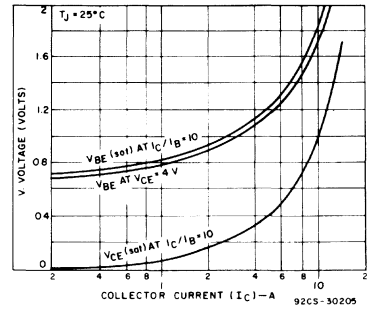


Fig. 5 — Typical voltage characteristics for 2N5879 and 2N5880.

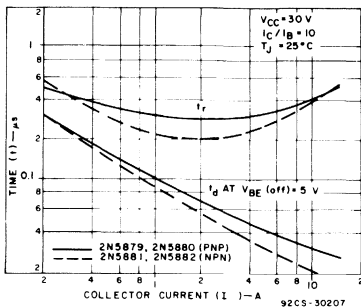


Fig. 6 — Typical turn-on time for all types.

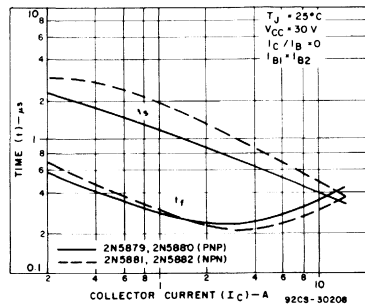


Fig. 7 — Typical turn-off time for all types.

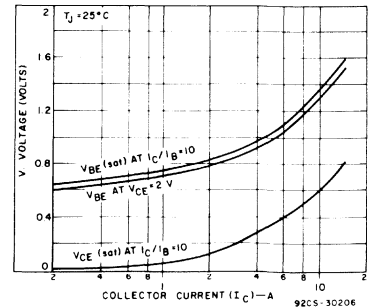


Fig. 8 — Typical voltage characteristics for 2N5881 and 2N5882.

2N5885, 2N5886

High-Current, High-Power, High-Speed N-P-N Power Transistors

The RCA-2N5885 and 2N5886 are epitaxial-base silicon n-p-n transistors intended for a wide variety of high-power, high-current applications, such as power-switching circuits, driver and output stages for series and shunt

regulators, dc-to-dc converters, inverters, and solenoid (hammer)/relay drivers.

These devices differ in maximum voltage ratings. They are supplied in JEDEC TO-204MA hermetic steel packages.

Features:

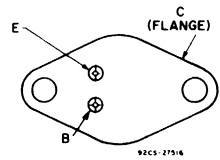
- Specification for h_{FE} and $V_{CE(sat)}$ up to 25 A
- Current gain bandwidth product
 $f_T = 4$ MHz (min.) at 1 A
- Low saturation voltage with high beta
- High dissipation capability
- 90 mJ $E_{S/b}$ characteristic

MAXIMUM RATINGS, Absolute-Maximum Values:

	2N5885	2N5886	
* V_{CBO}	60	80	V
* $V_{CEO(sus)}$	60	80	V
* V_{EBO}	5	5	V
* I_C	25	25	A
* I_{CM}	50	50	A
* I_B	7.5	7.5	A
* I_{BM}	15	15	A
* P_T			W
At $T_C \leq 25^\circ C$	200	200	
At $T_C > 25^\circ C$	Derate linearly		$W/^\circ C$
	See Figs. 1 and 2		
* T_{stg}, T_J	-65 to 200	-65 to 200	$^\circ C$
T_L			$^\circ C$
At distance $\geq 1/32$ in. (0.8 mm) from seating plane for 10 s max.	230	230	$^\circ C$

* In accordance with JEDEC registration data format JS-6 RDF-1.

TERMINAL DESIGNATIONS



JEDEC TO-204MA

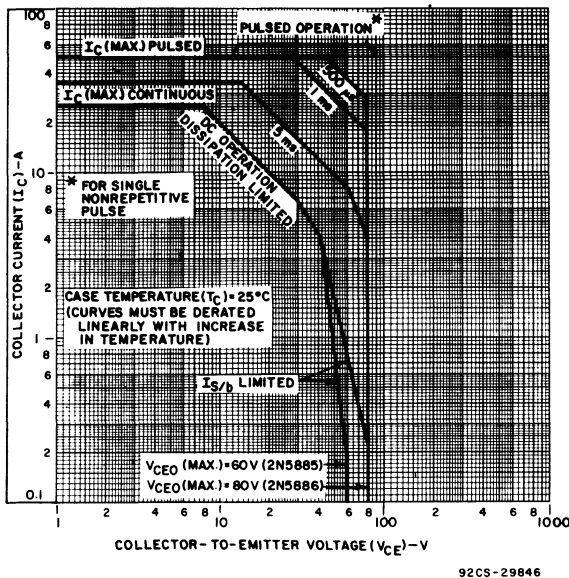


Fig. 1 - Maximum operating areas for 2N5885 and 2N5886.

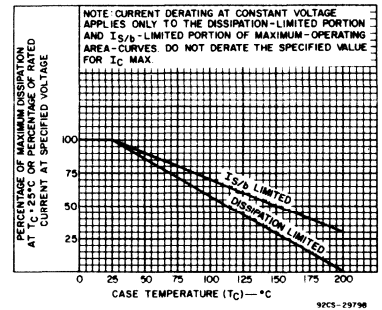


Fig. 2 - Derating curves for 2N5885 and 2N5886.

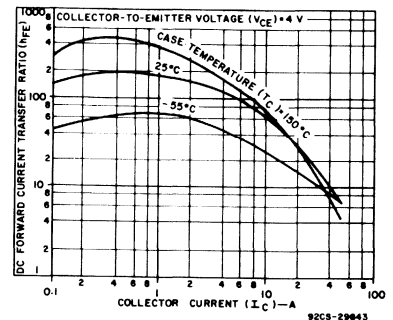


Fig. 3 - Typical dc beta characteristics as a function of collector current for 2N5885 and 2N5886.

2N5885, 2N5886

ELECTRICAL CHARACTERISTICS, At Case Temperature (T_C) = 25°C
 Unless Otherwise Specified

CHARACTERISTIC	TEST CONDITIONS				LIMITS				UNITS
	VOLTAGE V dc		CURRENT A dc		2N5885		2N5886		
	V_{CE}	V_{BE}	I_C	I_B	Min.	Max.	Min.	Max.	
I_{CBO}	60 ^a 80 ^a				—	1	—	—	mA
I_{CEX}	60 80	-1.5 -1.5			—	1	—	1	
I_{CEX} $T_C = 150^\circ\text{C}$	60 80	-1.5 -1.5			—	10	—	10	
I_{CEO}	30 40				—	2	—	2	
I_{EBO}		-5			—	1	—	1	
h_{FE}	4 4 4		3 ^b 10 ^b 25 ^b		35 20 4	— 100 —	35 20 4	— 100 —	V
$V_{CEO}(sus)$			0.2		60	—	80	—	
V_{BE}	4		10		—	1.5	—	1.5	
$V_{BE}(sat)$			25 ^b	6.25	—	2.5	—	2.5	
$V_{CE}(sat)$			15 ^b 25 ^b	1.5 6.25	— —	1 4	— —	1 4	
$I_{S/b}$ $t_p = 1\text{ s}$ nonrep.	20				10	—	10	—	A
$E_{S/b}$ $L = 125\ \mu\text{H}$, $R_{BE} = 51\ \Omega$ $L = 20\ \text{mH}$, $R_{BE} = 100\ \Omega$		-1.5 0	10 3		6.25 90	— —	6.25 90	— —	mJ
$ h_{fe} $ $f = 1\ \text{MHz}$	10		1		4	—	4	—	
h_{fe} $f = 1\ \text{kHz}$	4		3		20	—	20	—	
C_{obo} $f = 1\ \text{MHz}$	10 ^a				—	500	—	500	pF
t_r	$V_{CC} = 30$		10	1	—	0.7	—	0.7	μs
t_s			10	1 ^c	—	1	—	1	
t_f			10	1 ^c	—	0.8	—	0.8	
$R_{\theta JC}$	20		5		—	0.875	—	0.875	$^\circ\text{C/W}$

^aIn accordance with JEDEC registration data format JS-6 RDF-1.

^a V_{CB} .

^bPulsed; pulse duration = 300 μs , duty factor = 1.8%.

^c $I_{B1} = -I_{B2}$.

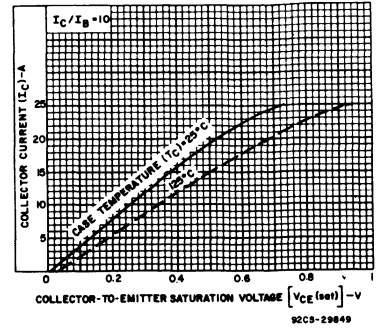


Fig. 4 — Typical saturation voltage characteristics for 2N5885 and 2N5886.

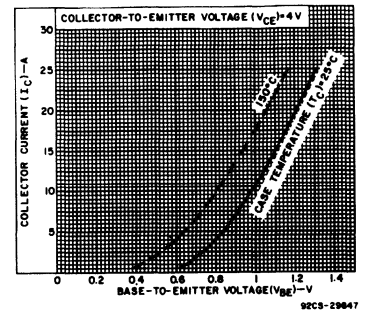


Fig. 5 — Typical transfer characteristics for 2N5885 and 2N5886.

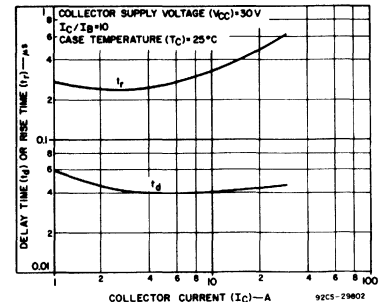


Fig. 6 — Typical delay-time and rise-time characteristics as a function of collector current for 2N5885 and 2N5886.

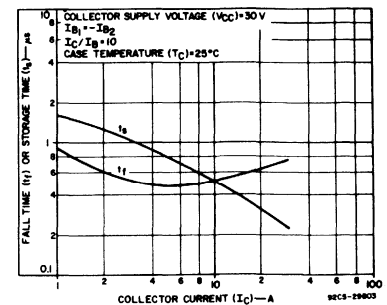


Fig. 7 — Typical storage-time and fall-time characteristics as a function of collector current for 2N5885 and 2N5886.

2N5954-2N5956, 2N6372-2N6374, 2N6465-2N6468, 40829-40831

Silicon N-P-N and P-N-P Medium-Power Transistors

General-Purpose Types for Switching Applications

RCA-2N5954, -2N5955, and -2N5956 are multiple-epitaxial p-n-p transistors. RCA-2N6372, -2N6373, and -2N6374 are multiple-epitaxial n-p-n transistors. They are complements to 2N5954, 2N5955, and 2N5956.

The RCA-2N6465 and 2N6466 are multiple-epitaxial n-p-n transistors. They are complements to the 2N6467, and 2N6468, multiple-epitaxial p-n-p transistors. These devices differ in voltage ratings and in the currents at which the parameters are controlled.

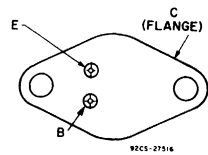
All are supplied in the JEDEC TO-66 package.

Types 2N5954, 2N5955, and 2N5956 are available with factory-attached heat radiators as RCA types 40829, 40830, and 40831, respectively. The other devices may be obtained with heat radiators on special order. Radiator versions are intended for printed-circuit-board applications, and differ electrically from their basic counterparts only in device dissipation (5.8 W up to 25°C ambient) and thermal resistance (30°C/W max. at T_A = 25°C).

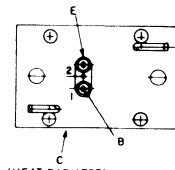
Features:

- 2N5954-2N5956 complements to 2N6372-2N6374
- 2N6465, 2N6466 complements to 2N6467, 2N6468
- Low saturation voltages
- Maximum-safe-area-of-operation curves
- Thermal-cycle ratings
- Hermetically-sealed JEDEC TO-66 package

TERMINAL DESIGNATIONS



JEDEC TO-66
2N5954-2N5956 2N6372-2N6374, 2N6465-2N6468



(HEAT RADIATOR)
JEDEC TO-66 with Heat Radiator
40829, 40830, 40831

MAXIMUM RATINGS, Absolute-Maximum Values:

	N-P-N 2N6374	2N6373	2N6372	2N6465	2N6466
	P-N-P 2N5956 40831*	2N5955* 40830*	2N5954* 40829*	2N6467*	2N6468*
V _{CBO} (sus)	50	70	90	110	130
V _{CEX} (sus) V _{BE} = -1.5 V, R _{BE} = 100 Ω	50	70	90	110	130
V _{CER} (sus) R _{BE} = 100 Ω	45	65	85	105	125
V _{CEO} (sus)	40	60	80	100	120
V _{EBO}	5	5	5	5	5
I _C	6	6	6	4	4
I _B	2	2	2	2	2
P _T	At T _C up to 25°C	40	40	40	40
	(2N6374)	(2N6373)	(2N6372)		
	(2N5956)	(2N5955)	(2N5954)		
	5.8	5.8	5.8		
	(40831)	(40830)	(40829)		
	Derate linearly to 200°C				
					40
	At T _A up to 25°C				
	At T _C above 25°C	Derate linearly to 200°C			
T _J , T _{stg}	-65 to +200				
T _L	At distances ≥ 1/32 in. (0.8 mm) from seating plane for 10 s max. +235				

*JEDEC types in accordance with JEDEC registration data format JS-6-RDF-2.

♦For p-n-p devices, voltage and current values are negative.

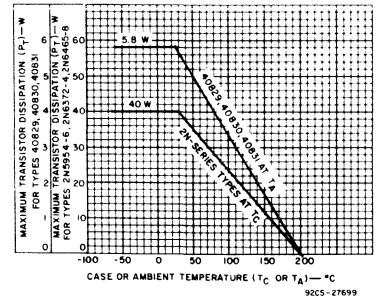


Fig. 1 - Dissipation derating chart for all types.

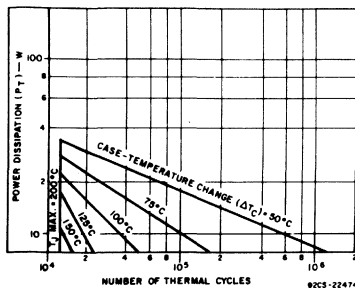


Fig. 2 - Thermal-cycling rating chart for all types.

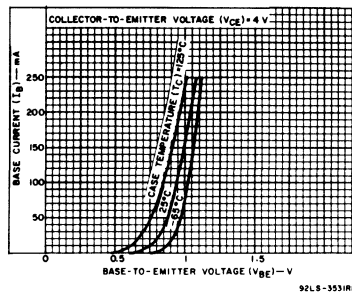


Fig. 3 - Typical input characteristics for 2N5954-56, 2N6372-74 and 40829-31.

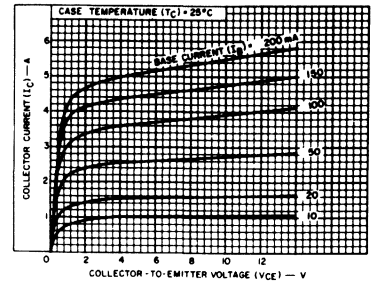


Fig. 4 - Typical output characteristics for 2N5954-56, 2N6372-74 and 40829-31.

♦For p-n-p devices, voltage and current values are negative.

2N5954-2N5956, 2N6372-2N6374, 2N6465-2N6468, 40829-40831

ELECTRICAL CHARACTERISTICS, At Case Temperature (T_C) = 25°C unless otherwise specified

CHARACTERISTIC	TEST CONDITIONS				LIMITS						U N I T S
	VOLTAGE V dc		CURRENT A dc		2N6374 2N5956 40831		2N6373 2N5955 40830		2N6372 2N5954 40829		
	V_{CE}	V_{BE}	I_C	I_B	Min.	Max.	Min.	Max.	Min.	Max.	
I_{CER} $R_{BE}=100\ \Omega$	35 55 75				-	100	-	-	-	-	μA
I_{CEX} $R_{BE}=100\ \Omega$	45 65 85	-1.5 -1.5 -1.5			-	100	-	-	-	-	μA
$R_{BE}=100\ \Omega$ $T_C=150^\circ C$	45 65 85	-1.5 -1.5 -1.5			-	2	-	-	-	-	mA
I_{CEO}	25 45 65				-	1	-	-	-	-	mA
I_{EBO}		-5			-	0.1	-	0.1	-	0.1	mA
h_{FE}	4 4 4 4		3a 2.5a 2a 6a		20 100 - 5	100 - - 5	-	20 100 - 5	-	- - 20 100	
$V_{CEO}(sus)$			0.1a		40b	-	60b	-	80b	-	
$V_{CER}(sus)$ $R_{BE}=100\ \Omega$			0.1a		45b	-	65b	-	85b	-	V
$V_{CEX}(sus)$ $R_{BE}=100\ \Omega$		-1.5	0.1a		50b	-	70b	-	90b	-	
V_{BE} All types All types All types 2N6372-2N6374	4 4 4 4		3a 2.5a 2a 6a		- - - - 3	2 - - - 3	-	- 2 - - 3	-	- - 2 - 3	V
$V_{CE}(sat)$ 2N5954-2N5956			3a 2.5a 2a 6	0.3 0.25 0.2 1.2	- - - - 2	1 - - - 2	-	- 1 - - 2	-	- - 1 - 2	V
$ h_{fe} $ f=1 MHz 2N6372-2N6374 2N5954-56,40829-31	4 -4		1 -1		4 5	-	4 5	-	4 5	-	
h_{fe} f=1 kHz	4		0.5		25	-	25	-	25	-	
$R_{\theta JC}$ 2N5954-56, 2N6372-74					-	4.3	-	4.3	-	4.3	$^{\circ}C/W$
$R_{\theta JA}$ 40829-40831					-	30	-	30	-	30	$^{\circ}C/W$

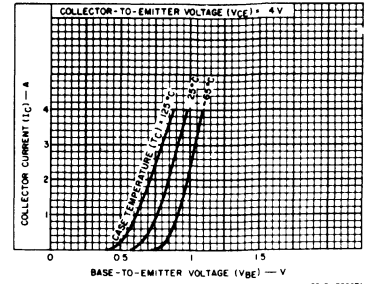


Fig. 5 - Typical transfer characteristics for 2N5954-56, 2N6372-74 and 40829-31.

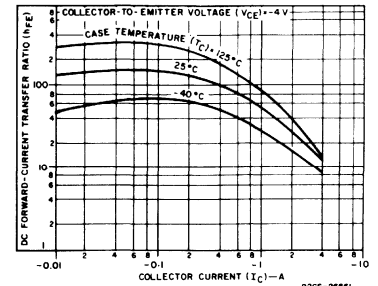


Fig. 6 - Typical dc beta characteristics for 2N6467 and 2N6468.

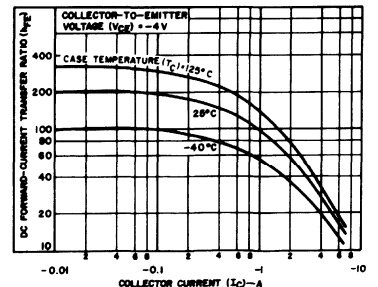


Fig. 7 - Typical dc beta characteristics for 2N5954-2N5956 and 40829-40831.

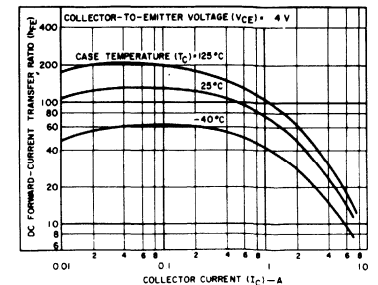


Fig. 8 - Typical dc beta characteristics for 2N6372-2N6374.

* In accordance with JEDEC registration data format JS-6 RDF-2 for JEDEC (2N5954-2N5956, 2N6372-2N6374, 2N6465-2N6468, 40829-40931) types.

♦ For p-n-p devices, voltage and current values are negative.

a Pulsed, pulse duration = 300 μs , duty factor = 1.8%.

b CAUTION: Sustaining voltages $V_{CEO}(sus)$, $V_{CER}(sus)$, and $V_{CEX}(sus)$ MUST NOT be measured on a curve tracer.

♦ For p-n-p devices, voltage and current values are negative.

2N5954-2N5956, 2N6372-2N6374, 2N6465-2N6468, 40829-40831

ELECTRICAL CHARACTERISTICS, At Case Temperature (T_C) = 25°C
unless otherwise specified

CHARACTERISTIC	TEST CONDITIONS				LIMITS				UNITS
	VOLTAGE V dc		CURRENT A dc		2N6465 2N6467♦		2N6486 2N6468♦		
	V_{CE}	V_{BE}	I_C	I_B	Min.	Max.	Min.	Max.	
I_{CER} $R_{BE} = 100 \Omega$	95				-	100	-	-	μA
	100				-	-	-	100	
* I_{CEX} $R_{BE} = 100 \Omega$	100	-1.5			-	100	-	-	μA
	120	-1.5			-	-	-	100	
$R_{BE} = 100 \Omega$, $T_C = 150^\circ C$	100	-1.5			-	2	-	-	mA
	120	-1.5			-	-	-	2	
* I_{CEO}	50				-	1	-	-	mA
	60				-	-	-	1	
* I_{EBO}		-5			-	0.1	-	0.1	mA
* h_{FE}	4		1.5 ^a		15	150	15	150	
	4		4 ^a		5	5	5	5	
* $V_{CE0}(sus)$			0.1 ^a		100 ^b	-	120 ^b	-	
$V_{CER}(sus)$ $R_{BE} = 100 \Omega$			0.1 ^a		105 ^b	-	125 ^b	-	V
* $V_{CEX}(sus)$ $R_{BE} = 100 \Omega$		-1.5	0.1 ^a		110 ^b	-	130 ^b	-	
* V_{BE}	4		1.5 ^a		-	2	-	2	V
	4		4 ^a		-	3.5	-	3.5	
$V_{CE}(sat)$	All types		1.5 ^a	0.15	-	1.2	-	1.2	V
	2N6465-2N6466		4 ^a	0.8	-	3*	-	3*	
	2N6467-2N6468		4 ^a	-0.8	-	4*	-	4*	
* $ h_{fe} $ f = 1 MHz	4		1		5	-	5	-	
* h_{fe} f = 1 kHz	4		0.5		25	-	25	-	
$R_{\theta JC}$					-	4.3	-	4.3	$^\circ C/W$

* In accordance with JEDEC registration data format JS-6 RDF-2.

♦ For p-n-p devices, voltage and current values are negative.

^a Pulsed, pulse duration = 300 μs , duty factor = 1.8%

^b CAUTION: Sustaining voltages $V_{CE0}(sus)$, $V_{CER}(sus)$, and $V_{CEX}(sus)$ MUST NOT be measured on a curve tracer.

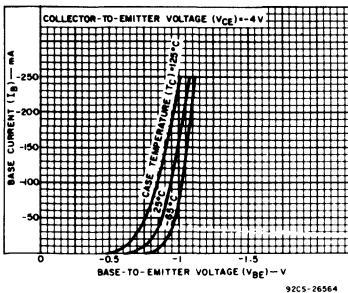


Fig. 12 - Typical input characteristics for 2N6467 and 2N6468.

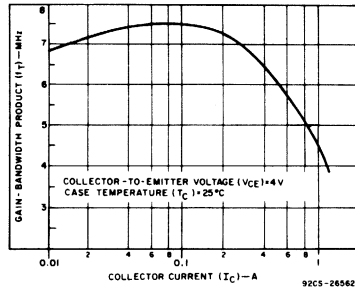


Fig. 13 - Typical gain-bandwidth product for 2N6465 and 2N6466.

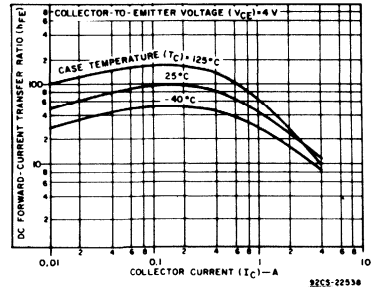


Fig. 9 - Typical dc beta characteristics for 2N6465 and 2N6466.

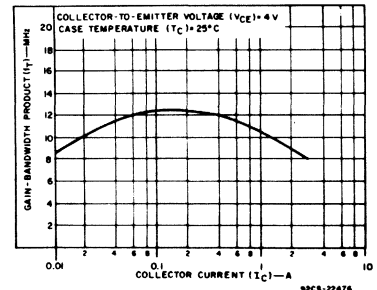


Fig. 10 - Typical gain-bandwidth product for 2N5954-56, 2N6372-74, 2N6467-68, and 40829-31. (For p-n-p devices, voltage and current values are negative.)

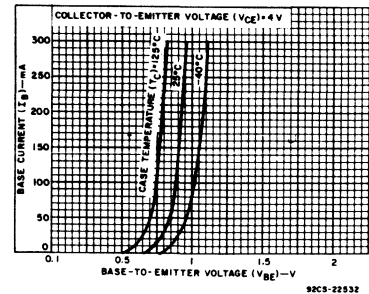


Fig. 11 - Typical input characteristics for 2N6465 and 2N6466.

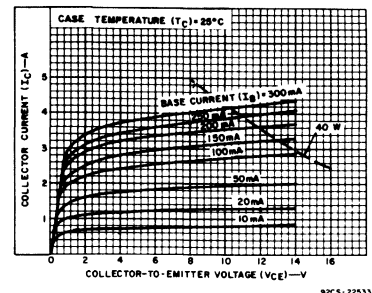


Fig. 14 - Typical output characteristics for 2N6465 and 2N6466.

2N5954-2N5956, 2N6372-2N6374, 2N6465-2N6468, 40829-40831

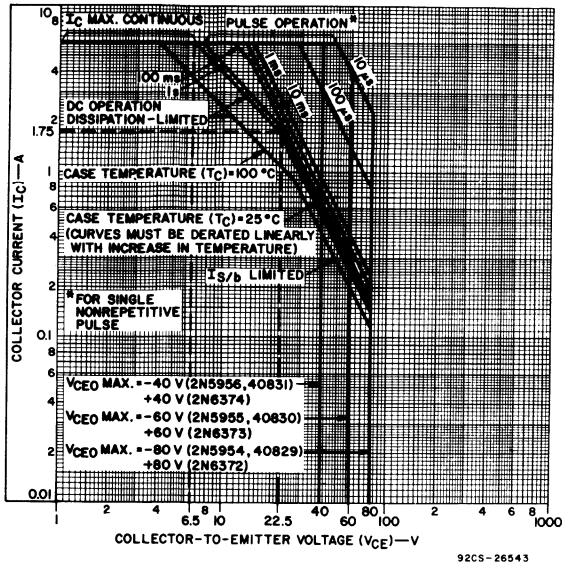


Fig. 15 - Maximum operating areas for 2N5954-56, 2N6372-74, and 40829-31. ♦

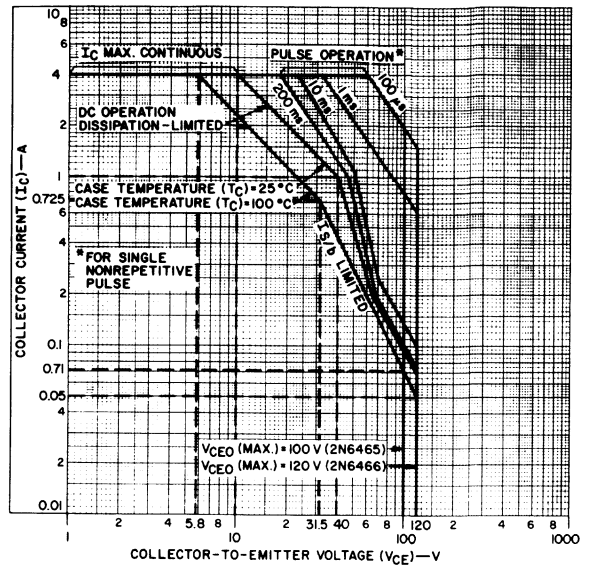


Fig. 16 - Maximum operating areas for 2N6465 and 2N6466.

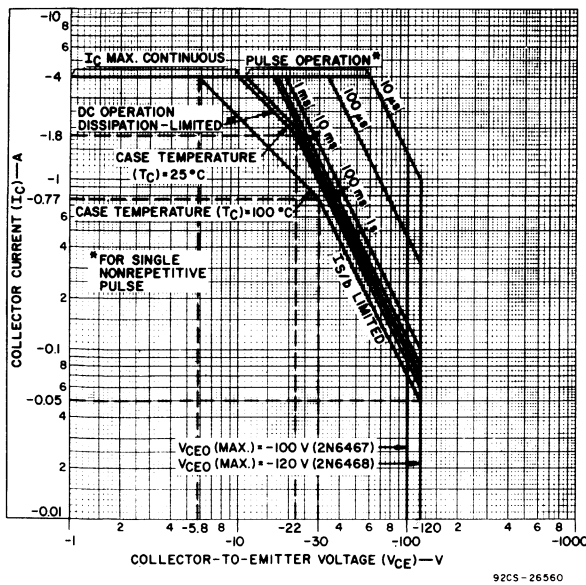


Fig. 17 - Maximum operating areas for 2N6467 and 2N6468.

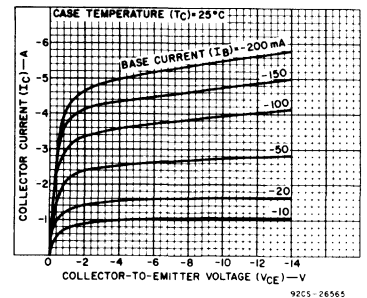


Fig. 18 - Typical output characteristics for 2N6467 and 2N6468.

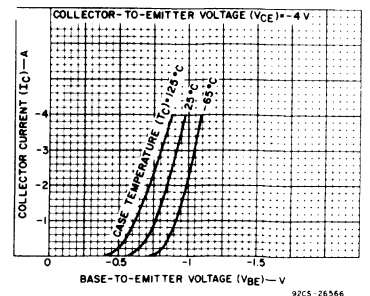


Fig. 19 - Typical transfer characteristics for 2N6467 and 2N6468.

♦For p-n-p devices, voltage and current values are negative.

2N5954-2N5956, 2N6372-2N6374, 2N6465-2N6468, 40829-40831

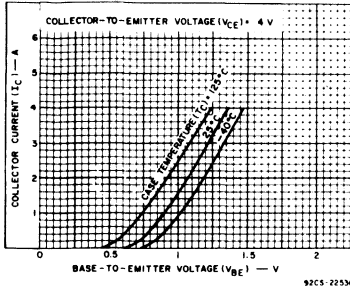


Fig. 20 - Typical transfer characteristics for 2N6465 and 2N6466.

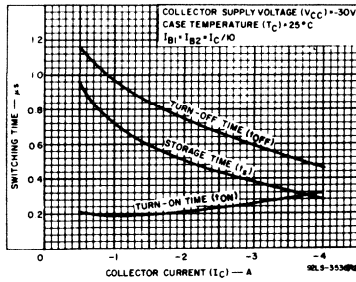


Fig. 21 - Typical saturated switching characteristics for 2N5954-56 and 40829-31.

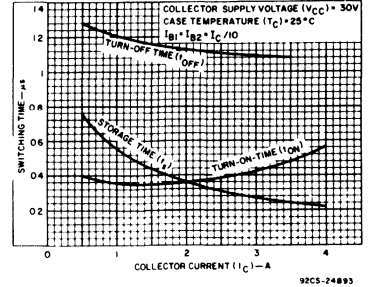


Fig. 22 - Typical saturated switching characteristics for 2N6372-2N6374.

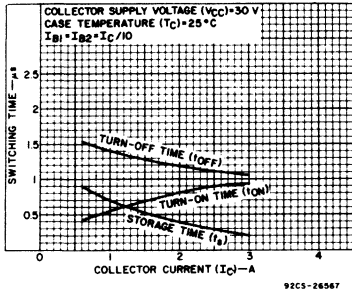


Fig. 23 - Typical saturated switching characteristics for 2N6465 and 2N6466.

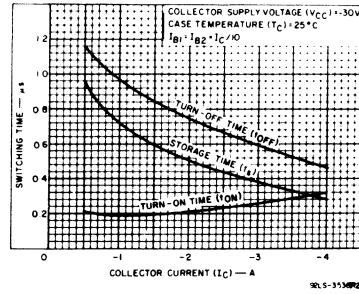


Fig. 24 - Typical saturated switching characteristics for 2N6467 and 2N6468.

2N6032, 2N6033

High-Current, High-Speed, High-Power Transistors

Silicon N-P-N Types

For Switching and Amplifier Applications in Military, Industrial, and Commercial Equipment

RCA Types 2N6032 and 2N6033* are epitaxial silicon n-p-n transistors having high-current and high-power handling capability and fast switching speed. The 2N6033 is similar to the 2N6032; they differ in maximum values for continuous collector current and sustaining voltage.

They are supplied in modified TO-3 hermetic steel packages with 0.60-in. diameter pins.

*Formerly RCA Dev. Types TA7337 and TA7337A, respectively.

Applications:

- Switching-control amplifiers
- Power gates
- Switching regulators
- Power-switching circuits
- Power oscillators
- DC-RF amplifiers
- Converters
- Inverters
- Control circuits

Features:

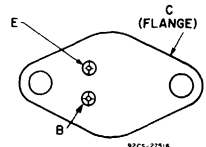
- Low $V_{CE(sat)}$ = 1.0 V max. at 40 A, 1.3 V max. at 50 A
- Maximum Safe-Area-of-Operation Curve... I_S/I_B limit line beginning at 24 V
- Fast Storage Time... $t_s = 1.5 \mu s$ max at $I_C = 40$ A (2N6033) 50 A (2N6032)
- High-Current Capability... $V_{CE(sat)}$ & V_{BE} measured at $I_C = 40$ A (2N6033) = 50 A (2N6032)
- High P_T (140 W max. at $T_C = 25^\circ C$)

MAXIMUM RATINGS, Absolute Maximum Values:

	2N6032	2N6033
COLLECTOR-TO-BASE VOLTAGE V_{CBO}	120	150
COLLECTOR-TO-EMITTER SUSTAINING VOLTAGE $V_{CE(sus)}$	90	120
With base open, $V_{CE(sus)}$	110	140
With external base-to-emitter resistance (R_{BE}) $\leq 50 \Omega$, $V_{CER(sus)}$	110	140
With external base-to-emitter resistance (R_{BE}) $\leq 50 \Omega$ & $V_{BE} = -1.5$ V, $V_{CEX(sus)}$	120	150
EMITTER-TO-BASE VOLTAGE V_{EBO}	7	7
CONTINUOUS COLLECTOR CURRENT I_C	50	40
BASE CURRENT I_B	10	10
EMITTER CURRENT I_E	50	40
TRANSISTOR DISSIPATION P_T		
At case temperatures up to $25^\circ C$ and V_{CE} up to 24 V	140	140
At case temperatures above $25^\circ C$	Derate linearly to $200^\circ C$	
TEMPERATURE RANGE: Storage & Operating (Junction)	-65 to +200 $^\circ C$	
PIN TEMPERATURE (During Soldering): At distances $\geq 1/32$ in. (0.8 mm) from seating plane for 10 s max.	230 $^\circ C$	

*In accordance with JEDEC registration data format JS-6 RDF-1.

TERMINAL DESIGNATIONS



Modified JEDEC TO-3

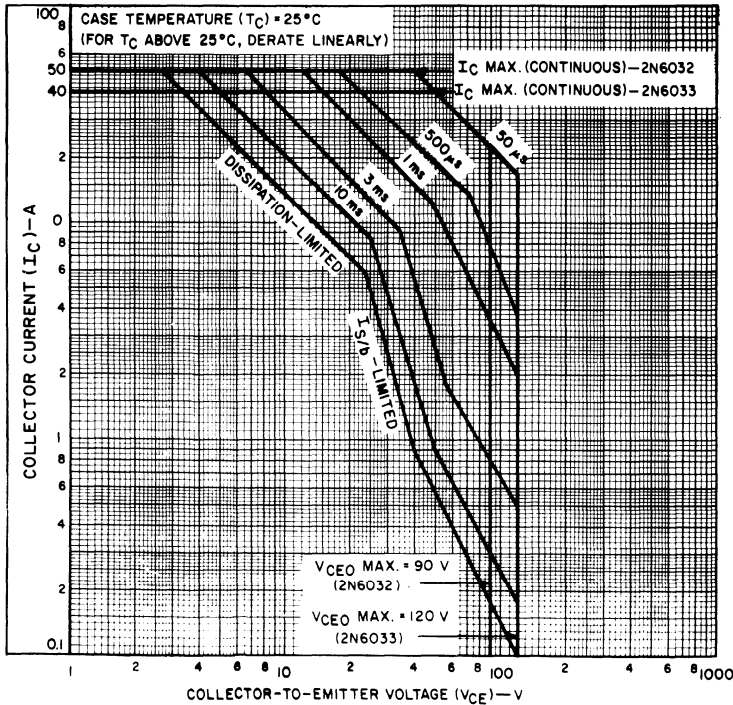


Fig. 1 - Maximum operating areas for both types.

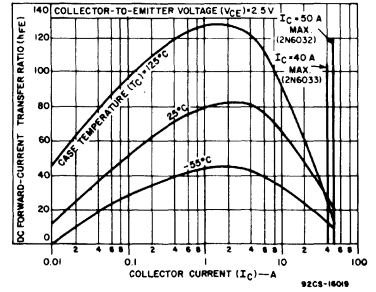


Fig. 2 - Typical de-beta characteristics for both types.

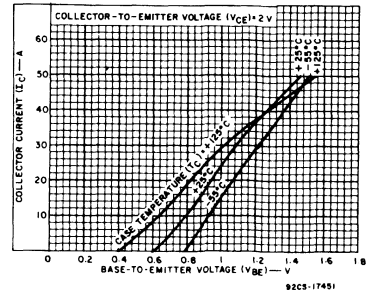


Fig. 3 - Typical transfer characteristics for both types.

2N6032, 2N6033

ELECTRICAL CHARACTERISTICS, Case Temperature (T_C) = 25°C Unless Otherwise Specified

CHARACTERISTIC	SYMBOL	TEST CONDITIONS				LIMITS				UNITS
		VOLTAGE		CURRENT		2N6032		2N6033		
		V dc	A dc	Min	Max	Min	Max	Min	Max	
Collector-Cutoff Current: With base open	I_{CEO}	80	-	-	0	-	10	-	10	mA
With base-emitter junction reverse biased $T_C = 150^\circ\text{C}$	I_{CEV}	110	-1.5	-	-	-	12	-	-	mA
		135	-1.5	-	-	-	-	-	10	mA
		100	-1.5	-	-	-	15	-	10	mA
Emitter-Cutoff Current	I_{EBO}	-	-7	0	-	-	10	-	10	mA
Collector-to-Emitter Sustaining Voltage: (See Figs. 12 & 13) With base open	$V_{CEO(sus)}$	-	-	0.2 ^b	0	90 ^a	-	120 ^a	-	V
With external base to emitter resistance ($R_{BE} \leq 50 \Omega$)	$V_{CER(sus)}$	-	-	0.2 ^b	0	110 ^a	-	140 ^a	-	V
With base-emitter junction reverse biased & $R_{BE} \leq 50 \Omega$	$V_{CEX(sus)}$	-	-1.5	0.2 ^b	0	120 ^a	-	150 ^a	-	V
Base-to-Emitter Saturation Voltage	$V_{BE(sat)}$	-	-	50 ^b 40 ^b	5 4	-	2	-	2	V
Base-to-Emitter Voltage	V_{BE}	2 2	-	50 ^b 40 ^b	-	-	2	-	2	V
Collector-to-Emitter Saturation Voltage	$V_{CE(sat)}$	-	-	50 ^b 40 ^b	5 4	-	1.3	-	1	V
DC Forward-Current Transfer Ratio	h_{FE}	26 2	-	50 ^b 40 ^b	-	10	50	-	10	50
Second-Breakdown Collector Current With base forward biased, $t = 1$ s nonrepetitive	I_{Sb}	24 40	-	-	-	-	5.8 ^c 0.9 ^c	-	5.8 ^c 0.9 ^c	A
Second-Breakdown Energy With base reverse biased ($L = 310 \mu\text{H}$, $R_{BE} = 5 \Omega$)	$E_{S,b}$	-	-4	20	-	62	-	62	-	mJ
Magnitude of common-emitter small-signal, short-circuit, forward-current transfer ratio $f = 5$ MHz	$ h_{fe} $	10	-	2	-	10	-	10	-	-
Gain Bandwidth Product $f = 5$ MHz	f_T	10	-	2	-	50	-	50	-	MHz
Output Capacitance: $V_{CB} = 10$ V, $f = 1$ MHz	C_{obo}	-	-	-	-	-	800	-	800	pF
Thermal Resistance (Junction-to-Case)	$R_{\theta JC}$	10	-	10	-	-	1.25	-	1.25	$^\circ\text{C/W}$

^aIn accordance with JEDEC registration format JS-6 RDF-1.

^cCAUTION: The sustaining voltages $V_{CEO(sus)}$, $V_{CER(sus)}$, and $V_{CEX(sus)}$ MUST NOT be measured on a curve tracer.

^bPulsed: Pulse duration 300 μs ; duty factor $\leq 2\%$.

SWITCHING TIME CHARACTERISTICS, Case Temperature (T_C) = 25°C

CHARACTERISTIC	SYMBOL	TEST CONDITIONS				LIMITS				UNITS	
		VOLTAGE		CURRENT		2N6032		2N6033			
		V dc	A dc	Min	Max	Min	Max	Min	Max		
Saturated Switching Time: ($V_{CC}=30$ V, $I_{B1} = I_{B2}$):											
Rise Time	t_r	-	-	50 40	5 4	-	1	-	-	1	μs
Storage Time	t_s	-	-	50 40	5 4	-	1.5	-	-	1.5	μs
Fall Time	t_f	-	-	50 40	5 4	-	0.5	-	-	0.5	μs

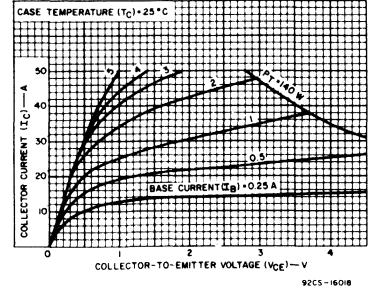


Fig. 4 - Typical output characteristics for both types.

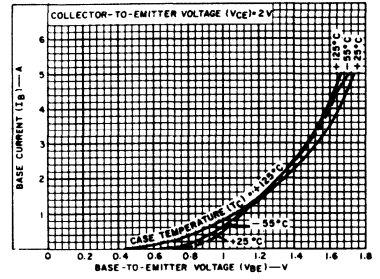


Fig. 5 - Typical input characteristics for both types.

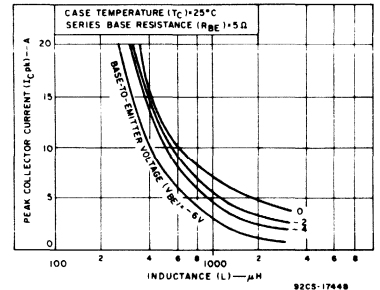


Fig. 6 - Maximum reverse-bias second-breakdown characteristics for both types.

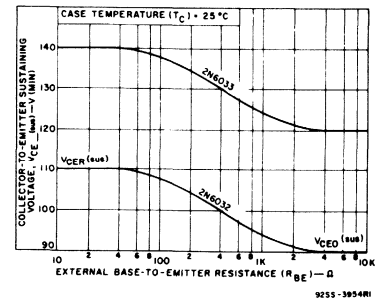


Fig. 7 - Collector-to-emitter sustaining voltage characteristics for both types.

2N6032, 2N6033

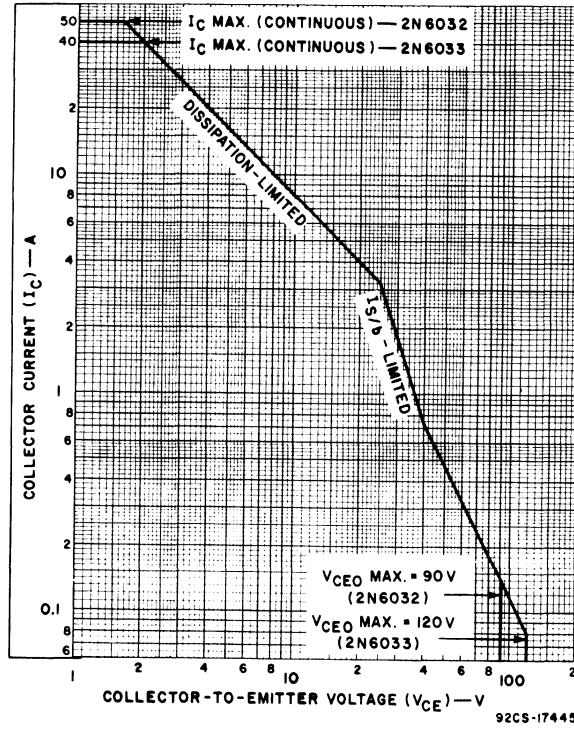


Fig. 8 - Maximum operating areas for both types at case temperature (T_C) = 100°C .

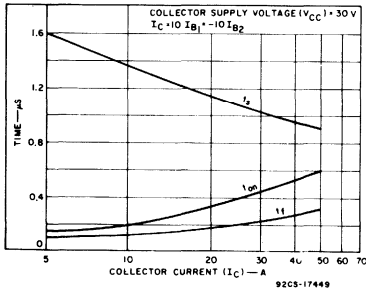


Fig. 9 - Typical saturated switching characteristics for both types.

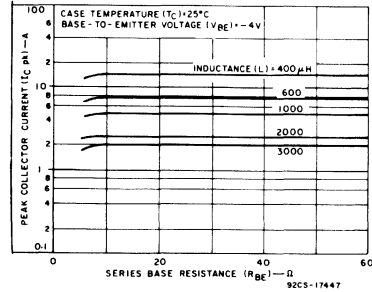


Fig. 10 - Maximum reverse-bias second-breakdown characteristics for both types.

2N6077-2N6079

High-Voltage, High-Power Silicon N-P-N Transistors

For Switching and Linear Applications

RCA 2N6077, 2N6078 and 2N6079 are multiple epitaxial silicon n-p-n power transistors utilizing a multiple-emitter-site structure. Multiple-epitaxial construction maximizes the volt-ampere characteristic of the device and provides fast switching speeds. Multiple-emitter-site design ensures uniform current flow throughout the structure, which produces a high $I_{S/B}$ and a large safe-operation area.

These devices use the popular JEDEC TO-66 package; they differ mainly in voltage ratings, leakage-current limits, and $V_{CE(sat)}$ ratings.

The 2N6077 is characterized for switching applications with load lines in the active region. These applications include sweep circuits and all circuits using the transistor as an active voltage clamp.

Type 2N6078 is characterized for switching applications with the load line extending into the reverse-bias region. Its voltage

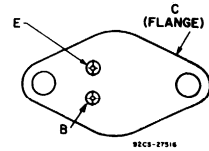
ratings make this device useful for switching regulators operating directly from a rectified 110-V or 220-V power line. The unit is rated to take surge currents up to 5 A and maintain saturation.

The 2N6079 is characterized for use in inverters operating directly from a rectified 110-V power line. The leakage current is specified at 450 volts; therefore the device can also be used in a series bridge configuration on a 220-V line. The V_{EBO} rating of 9 volts eases requirements on the drive transformer in inverter applications. Storage time, an important factor in the frequency stability of an inverter, is specified in Fig. 11, which shows variation in storage time with variation in load current from zero to maximum (4 A).

Features:

- Maximum safe-area-of-operation curves
- Low saturation voltages
- High voltage ratings:
 - $V_{CER(sus)} = 300\text{ V (2N6077)}$
 - 275 V (2N6078)
 - 375 V (2N6079)
- High dissipation rating: $P_T = 45\text{ W}$

TERMINAL DESIGNATIONS



MAXIMUM RATINGS, Absolute-Maximum Values:

	2N6077	2N6078	2N6079		
*COLLECTOR-TO-BASE VOLTAGE	V_{CBO}	300	275	375	V
COLLECTOR-TO-EMITTER SUSTAINING VOLTAGE:					
With base open	$V_{CEO(sus)}$	275	250	350	V
With reverse bias (V_{BE}) of -1.5 V	$V_{CEX(sus)}$	300	275	375	V
With external base-to-emitter resistance (R_{BE}) $\leq 500\ \Omega$	$V_{CER(sus)}$	300	275	375	V
*EMITTER-TO-BASE VOLTAGE	V_{EBO}	6	6	9	V
*COLLECTOR CURRENT:	I_C				
Continuous		7	7	7	A
Peak		10	10	10	A
*CONTINUOUS BASE CURRENT	I_B	4	4	4	A
*TRANSISTOR DISSIPATION:	P_T				
At case temperatures up to 25°C		45	45	45	W
At case temperatures above 25°C		Derate linearly to 200°C			
*TEMPERATURE RANGE:					
Storage & Operating (Junction)		-65 to +200		$^\circ\text{C}$	
*PIN TEMPERATURE (During Soldering):					
At distances $\geq 1/32\text{ in. (0.8 mm)}$ from case for 10 s max.		230		$^\circ\text{C}$	

* 2N-Series types in accordance with JEDEC registration data format (JS-6, RDF-1).

2N6077-2N6079

ELECTRICAL CHARACTERISTICS, At Case Temperature (T_C) = 25°C unless otherwise specified

CHARACTERISTIC SYMBOL	TEST CONDITIONS				LIMITS									UNITS
	VOLTAGE V dc		CURRENT A dc		2N6077			2N6078			2N6079			
	V _{CE}	V _{BE}	I _C	I _B	Min.	Typ.	Max.	Min.	Typ.	Max.	Min.	Typ.	Max.	
I _{CEO}	250			0	–	–	2	–	–	–	–	–	–	mA
* I _{CEV}	250	–1.5			–	–	5	–	–	0.05	–	–	–	mA
	450	–1.5			–	–	–	–	–	–	–	–	0.5	mA
(T _C = 125°C)	250	–1.5			–	–	8	–	–	0.2	–	–	–	mA
	450	–1.5			–	–	–	–	–	–	–	–	5	mA
* I _{EBO}		–6 –9	0 0		– –	– –	1 –	– –	– –	1 –	– –	– –	– 1	mA
* V _{CEO(sus)}			0.2 ^a		275 ^b	–	–	250 ^b	–	–	350 ^b	–	–	V
V _{CER(sus)} (R _{BE} = 500 Ω)			0.2 ^a		300 ^b	–	–	275 ^b	–	–	375 ^b	–	–	
* V _{V_{EBO}} (I _E = 1 mA)			0		6	–	–	6	–	–	9	–	–	V
* h _{FE}	1		1.2 ^a		12	28	70	12	28	70	12	28	50	
* V _{BE(sat)}			1.2 ^a	0.2	–	1.0	1.6	–	1.0	1.6	–	1.0	1.6	V
			3 ^a	0.6	–	1.2	1.9	–	–	–	–	–	–	
			4 ^a	0.8	–	–	–	–	–	–	–	1.3	2	
			5 ^a	1	–	–	–	–	1.5	2	–	–	–	
* V _{CE(sat)}			1.2 ^a	0.2	–	0.15	0.5	–	0.15	0.5	–	0.15	0.5	V
			3 ^a	0.6	–	0.25	1	–	–	–	–	–	–	
			4 ^a	0.8	–	–	–	–	–	–	–	0.5	3	
			5 ^a	1	–	–	–	–	0.8	3	–	–	–	
* C _{obo} (V _{CB} = 10 V, f = 1 MHz)					–	–	150	–	–	150	–	–	150	pF
* h _{fe} (f = 1 MHz)	10		0.2		1	7	–	1	7	–	1	7	–	
I _{S/b} (Pulse duration (non-repetitive) = 1 s)	50				0.9	–	–	0.9	–	–	0.9	–	–	A
E _{S/b} (R _B = 50Ω, L = 100μH)		–4	3 ^a		0.45	–	–	0.45	–	–	0.45	–	–	mj
* t _d ^c			1.2	0.2	–	0.02	–	–	0.02	–	–	0.02	–	μs
* t _r ^c			1.2	0.2	–	0.3	0.75	–	0.3	0.75	–	0.3	0.75	
* t _s ^c			1.2	0.2	–	2.8	5	–	2.8	5	–	2.8	5	
* t _f ^c			1.2	0.2	–	0.3	0.75	–	0.3	0.75	–	0.3	0.75	
R _{θJC}	20		2.25		–	–	3.9	–	–	3.9	–	–	3.9	°C/W

*2N-series types in accordance with JEDEC registration data format (JS-6, RDF-1).

^a Pulsed; pulse duration ≤ 350 μs, Duty factor = 2%.^b CAUTION: The sustaining voltages V_{CEO(sus)}, and V_{CER(sus)}, MUST NOT be measured on a curve tracer.^c V_{CC} = 250 V, I_{B1} = I_{B2}.

2N6077-2N6079

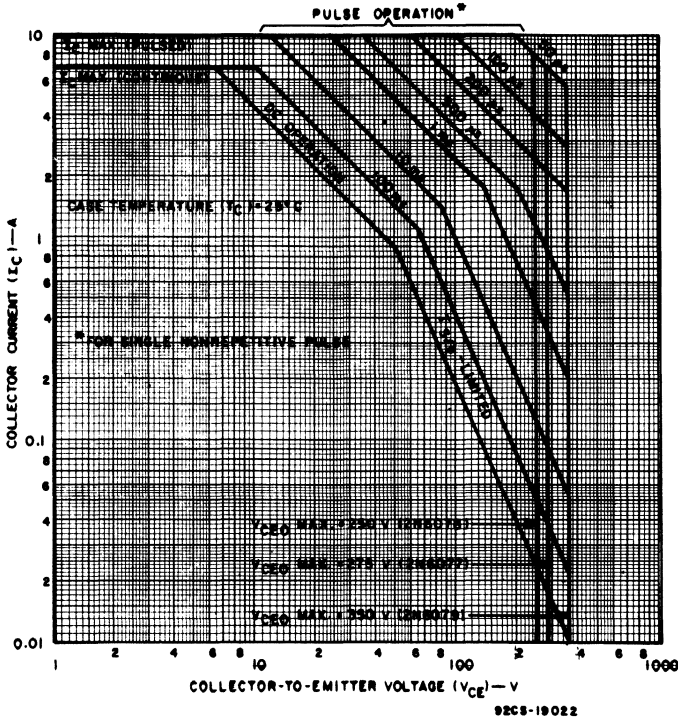


Fig. 1 - Maximum operating areas for all types.

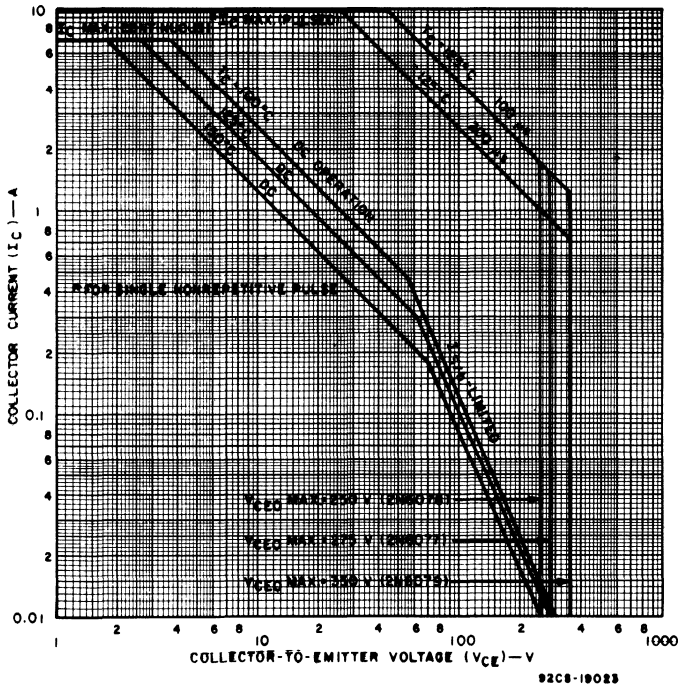


Fig. 4 - Maximum operating areas for all types.

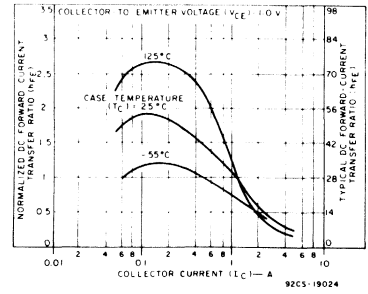


Fig. 2 - Typical normalized dc beta characteristics for all types.

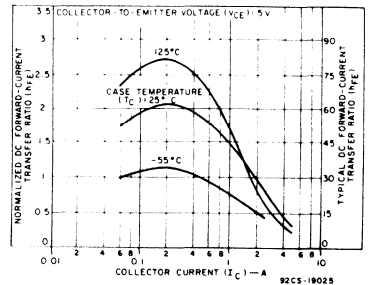


Fig. 3 - Typical normalized dc beta characteristics for all types.

Note (Figs. 2 & 3) To estimate min. max. hFE at any current and temperature, read normalized dc forward-current transfer ratio and multiply by min. max. specifications given in Electrical Characteristic Chart.

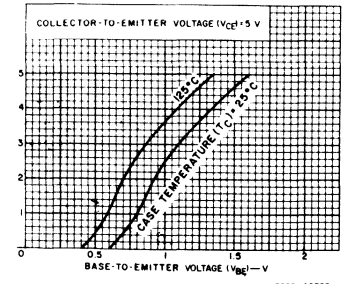


Fig. 5 - Typical transfer characteristics for all types.

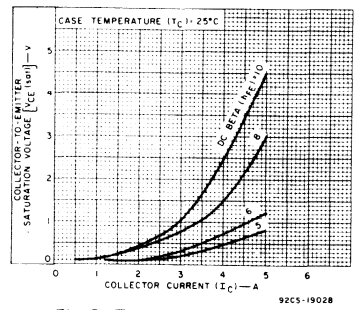


Fig. 6 - Typical saturation voltage characteristics for all types.

2N6077-2N6079

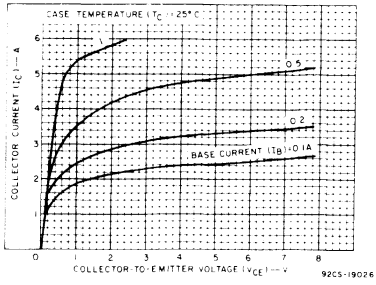


Fig. 7 - Typical output characteristics for all types.

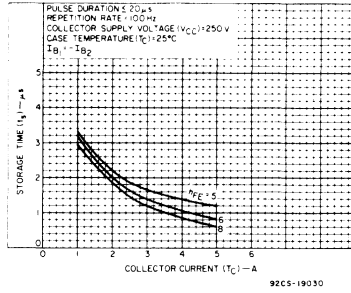


Fig. 8 - Typical storage-time characteristics for all types (with constant forced gain).

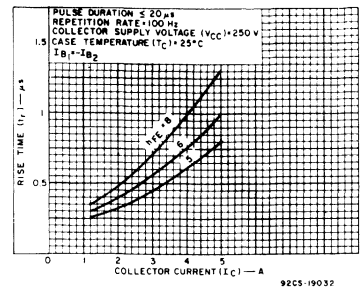


Fig. 9 - Typical rise-time characteristic for all types.

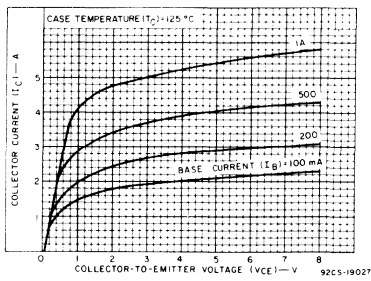


Fig. 10 - Typical output characteristics for all types.

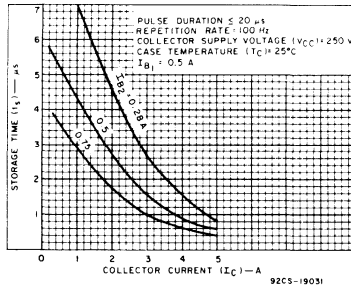


Fig. 11 - Typical storage-time characteristics for all types (with constant-base drives).

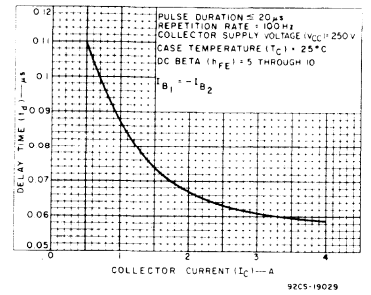


Fig. 12 - Typical delay-time characteristic for all types.

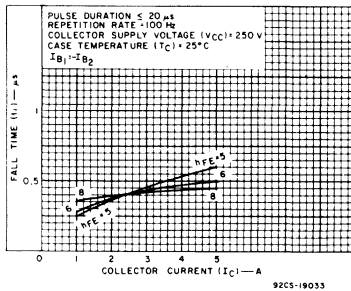


Fig. 13 - Typical fall-time characteristic for all types.

2N6098-2N6103, RCA3055

High-Current Silicon N-P-N VERSAWATT Transistor

Designed for Medium-Power Linear and Switching Service in Consumer, Automotive, and Industrial Applications

These RCA types are homotaxial-base silicon n-p-n transistors. Types 2N6098, 2N6100, and 2N6102 have formed emitter and base leads for easy insertion into TO-66 sockets. Types 2N6099, 2N6101, and 2N6103 are electrically identical to the 2N6098, 2N6100, and 2N6102, respectively.

These new VERSAWATT package transistors differ in voltage ratings and in the currents at which the parameters are controlled. They are intended for a wide

variety of medium-power switching and linear applications, such as series and shunt regulators, solenoid drivers, motor-speed controls, inverters, and driver and output stages of high-fidelity amplifiers.

OPTIONAL LEAD CONFIGURATION
An additional lead forming for printed-circuit board mounting is also available. Please submit requirements to your RCA Technical Sales Representative, or write to RCA Power Marketing, Somerville, N. J. 08876.

Features:

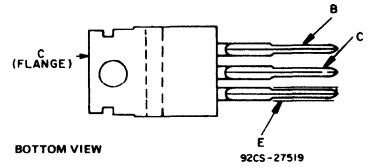
- Low saturation voltage –
 $V_{CE(sat)} = 1\text{ V max. at } I_C = 4\text{ A}$ (2N6098, 2N6099)
 $= 1\text{ V max. at } I_C = 5\text{ A}$ (2N6100, 2N6101)
 $= 1\text{ V max. at } I_C = 8\text{ A}$ (2N6102, 2N6103)
- VERSAWATT package (molded-silicone plastic)
- Maximum safe-area-of-operation curves
- Thermal-cycle rating curve

MAXIMUM RATINGS, Absolute-Maximum Values:

	2N6102 2N6103	2N6098 2N6099	2N6100 2N6101	RCA3055	
*COLLECTOR-TO-BASE VOLTAGE	45	70	80	100	V
COLLECTOR-TO-EMITTER SUSTAINING VOLTAGE					
With external base-to-emitter resistance (R_{BE}) = 100Ω	$V_{CER(sus)}$ 45	65	75	70	V
With base open	$V_{CEO(sus)}$ 40	60	70	60	V
With base reverse-biased $V_{BE} = -1.5\text{ V}$	$V_{CEV(sus)}$ —	—	—	90	V
*EMITTER-TO-BASE VOLTAGE	V_{EB0} 5	8	8	7	V
*COLLECTOR CURRENT (Continuous)	I_C 16	10	10	15	A
*BASE CURRENT	I_B 4	4	4	4	A
TRANSISTOR DISSIPATION					
At case temperatures up to 25°C	PT 75	75	75	75	W
At ambient temperatures up to 25°C	1.6	1.6	1.6	1.8	W/°C
At case temperatures above 25°C, derate linearly	— 0.6				W/°C
At ambient temperatures above 25°C, derate linearly	— 0.0144				W/°C
*TEMPERATURE RANGE	— 65 to 150				°C
Storage & Operating (Junction)	—				°C
*LEAD TEMPERATURE (During Soldering)	—				°C
At distance $\geq 1.8\text{ in. (3.17 mm)}$ from case of 10 s max.	— 235				°C

* 2N-Series types in accordance with JEDEC registration data format JS 6 RDP-2.

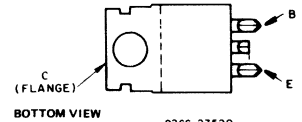
TERMINAL DESIGNATIONS



BOTTOM VIEW

92CS-27519

JEDEC TO-220AB
2N6098, 2N6101, 2N6103



BOTTOM VIEW

92CS-27520

JEDEC TO-220AA
2N6098, 2N6100, 2N6102

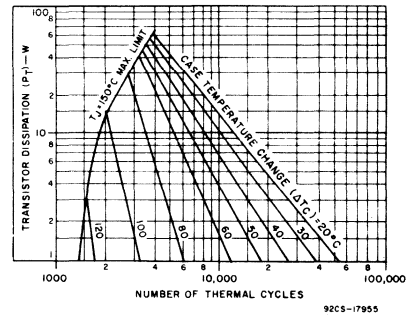


Fig. 2 – Thermal-cycling rating for all types.

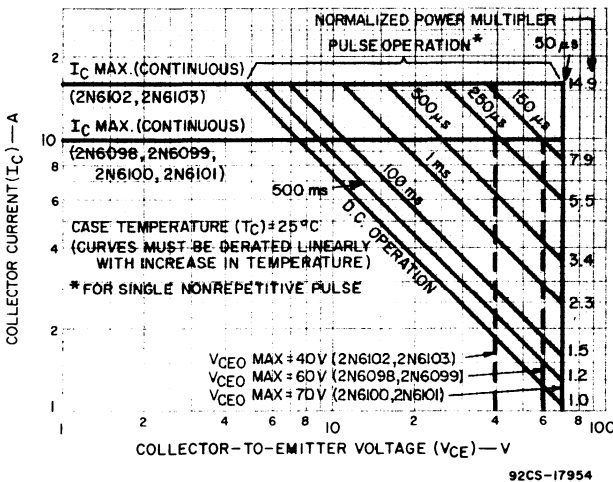


Fig. 1 – Maximum safe operating areas for 2N6098-2N6103, inclusive.

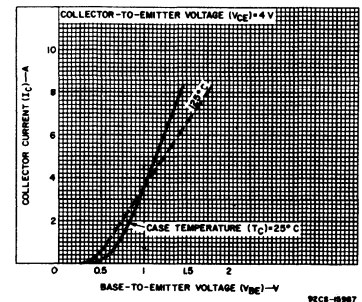


Fig. 3 – Typical transfer characteristics for all types.

2N6098-2N6103, RCA3055

ELECTRICAL CHARACTERISTICS, Case Temperature (T_C) = 25°C Unless Otherwise Specified

CHARACTERISTIC SYMBOL	TEST CONDITIONS				LIMITS								UNITS	
	VOLTAGE V dc		CURRENT A dc		2N6102 2N6103		2N6098 2N6099		2N6100 2N6101		RCA3055			
	V _{CE}	V _{EB}	I _C	I _B	MIN.	MAX.	MIN.	MAX.	MIN.	MAX.	MIN.	MAX.		
* I _{CEX}	40	1.5			—	2	—	—	—	—	—	—	mA	
	65	1.5			—	—	—	2	—	—	—	—		
	75	1.5			—	—	—	—	—	2	—	—		
	100	1.5			—	—	—	—	—	—	—	5		
* I _{CEX} (T _C = 150°C)	40	1.5			—	10	—	—	—	—	—	—	mA	
	65	1.5			—	—	—	10	—	—	—	—		
	75	1.5			—	—	—	—	—	10	—	—		
	100	1.5			—	—	—	—	—	—	—	30		
* I _{CEO}	30			0	—	2	—	—	—	—	—	0.7	mA	
	50			0	—	—	—	2	—	—	—	—		
	60			0	—	—	—	—	—	2	—	—		
* I _{EBO}		5	0		—	1	—	—	—	—	—	—	mA	
		7	0		—	—	—	—	—	—	—	5		
		8	0		—	—	—	1	—	1	—	—		
* V _{CER(sus)} R _{BE} = 100Ω ^a			0.2		45	—	65	—	75	—	70	—	V	
* V _{CEO(sus)} ^a			0.2	0	40	—	60	—	70	—	60	—		
* V _{CEV(sus)} ^a		1.5	0.1		—	—	—	—	—	—	90	—		
* h _{FE} ^a	4		4		—	—	20	80	—	—	20	70		
	4		5		—	—	—	—	20	80	—	—		
	4		8		15	60	—	—	—	—	—	—		
	4		10		—	—	5	—	5	—	5	—		
	4		16		5	—	—	—	—	—	—	—		
* V _{BE} ^a	4		4		—	—	—	1.7	—	—	—	1.8	V	
	4		5		—	—	—	—	—	1.7	—	—		
	4		8		—	1.7	—	—	—	—	—	—		
* V _{CE(sat)} ^a			4	0.4	—	—	—	—	—	—	—	1.1	V	
			10	2	—	—	—	2.5	—	2.5	—	—		
			16	3.2	—	2.5	—	—	—	—	—	—		
* I _{S/b} ^b (t ≥ 1 s)	60				—	—	—	—	—	—	1.2	—	A	
* f _{hfe}	4		1		—	—	—	—	—	—	10	—	kHz	
* h _{fe}	4	f=1 kHz	0.5		15	—	15	—	15	—	15	120		
* h _{fe}	4	f=0.1 MHz	0.5		8	28	8	28	8	28	2	—		
R _{θJC} R _{θJA}					—	1.67	—	1.67	—	1.67	—	1.67	70	°C/W

*2N-series types in accordance with JEDEC registration data format (JS-6, RDF-2)

^aPulsed, pulse duration = 300 μs, duty factor = 0.018

2N6098-2N6103, RCA3055

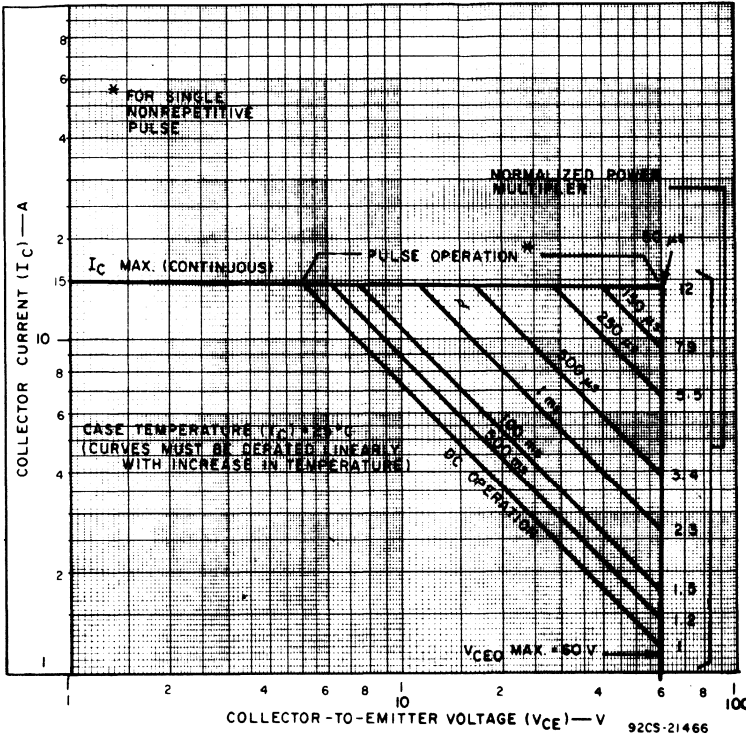


Fig. 4 - Maximum operating areas for RCA3055.

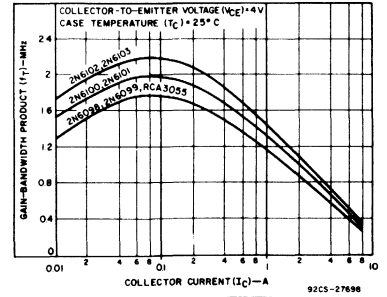


Fig. 5 - Typical gain-bandwidth product for all types.

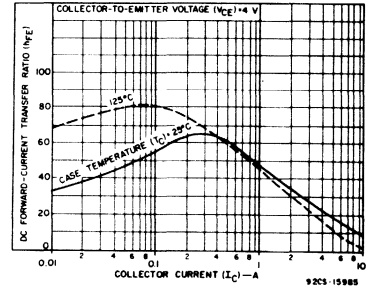


Fig. 6 - Typical dc beta characteristics for 2N6098, 2N6099, and RCA3055.

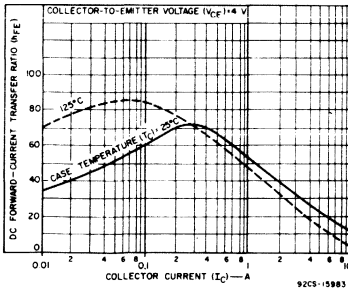


Fig. 7 - Typical dc beta characteristics for 2N6100 and 2N6101.

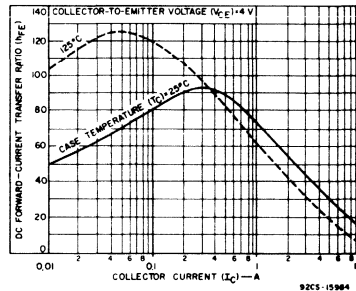


Fig. 8 - Typical dc beta characteristics for 2N6102 and 2N6103.

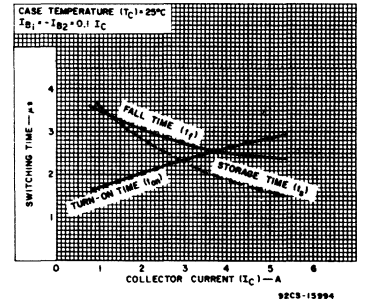


Fig. 9 - Typical saturated switching characteristics for all types.

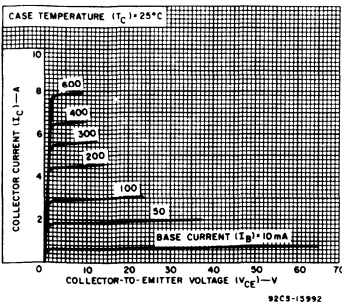


Fig. 10 - Typical output characteristics for 2N6098, 2N6099, and RCA3055.

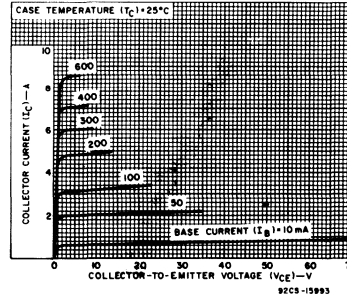


Fig. 11 - Typical output characteristics for 2N6100 and 2N6101.

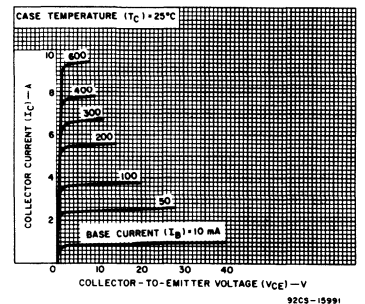


Fig. 12 - Typical output characteristics for 2N6102 and 2N6103.

2N6106-2N6111, 2N6288-2N6293, 2N6473-2N6476, 41500, 41501

Epitaxial-Base, Silicon N-P-N and P-N-P VERSAWATT Transistors

General-Purpose Medium-Power Types for Switching and Amplifier Applications

RCA 2N6106-2N6111, 2N6288-2N6293, and 2N6473-2N6476, 41500 and 41501 are epitaxial-base silicon transistors supplied in a VERSAWATT package. The 2N6288-2N6293, 2N6473, 2N6474, and 41500 are n-p-n complements of p-n-p types 2N6106-2N6111, 2N6475, 2N6476, and 41501, respectively. All these transistors are intended for a wide variety of medium-power switching and amplifier applications, such as series and shunt regulators and driver and output stages of high-fidelity amplifiers.

The 2N6289, 2N6291, and 2N6293 n-p-n types and 2N6106, 2N6108, and 2N6110 p-n-p devices fit into TO-66 sockets. The remaining types are supplied in the JEDEC TO-220AB straight-lead version of the VERSAWATT package. All of these devices are also available on special order in a variety of lead-form configurations.

Features:

- Low saturation voltages
- VERSAWATT package (molded silicone plastic)
- Complementary n-p-n and p-n-p types
- Thermal-cycling ratings
- Maximum safe-area-of-operation curves specified for dc operation

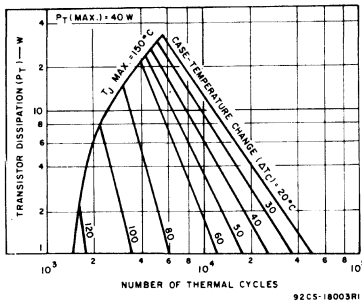
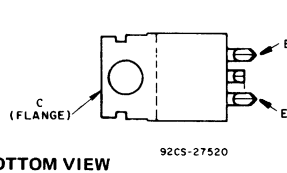


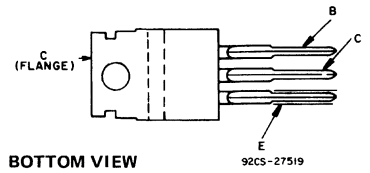
Fig. 1 - Thermal-cycling ratings for all types.

TERMINAL DESIGNATIONS



BOTTOM VIEW

JEDEC TO-220AA
2N6106, 2N6108, 2N6110
2N6289, 2N6291, 2N6293



BOTTOM VIEW

JEDEC TO-220AB
2N6107, 2N6109, 2N6111,
2N6288, 2N6290, 2N6292,
2N6473, 2N6474, 2N6475,
2N6476, 41500, 41501

MAXIMUM RATINGS, Absolute-Maximum Values:

- *COLLECTOR-TO-BASE VOLTAGE V_{CBO}
- *COLLECTOR-TO-EMITTER VOLTAGE:
With external base-supply resistance (R_{BB}) = 100Ω,
and base supply voltage (V_{BB}) = 0 V V_{CEX}
With base open V_{CEO}
- *EMITTER-TO-BASE VOLTAGE. V_{EBO}
- *COLLECTOR CURRENT (Continuous)
At case temperature ≤ 106°C I_C
*BASE CURRENT (Continuous)
At case temperature ≤ 130°C I_B
- TRANSISTOR DISSIPATION:
P_T
At case temperatures up to 25°C
At case temperatures up to 100°C
At ambient temperatures up to 25°C
At case temperatures above 25°C
At case temperatures above 100°C
At ambient temperatures above 25°C
- *TEMPERATURE RANGE:
Storage and Operating (Junction)
- *LEAD TEMPERATURE (During Soldering):
At distance ≥ 1/8 in. (3.17 mm) from case for 10 s max.

	2N6288	2N6290	2N6292			
N-P-N	2N6289	2N6291	2N6293	2N6473	2N6474	41500
P-N-P	2N6110♦	2N6108♦	2N6106♦	2N6475♦	2N6476♦	41501♦
	2N6111♦	2N6109♦	2N6107♦			
V _{CBO}	40	60	80	110	130	35
V _{CEX}	40	60	80	110	130	35
V _{CEO}	30	50	70	100	120	25
V _{EBO}	5	5	5	5	5	3
I _C	7	7	7	4	4	7
I _B	3	3	3	2	2	3
P _T						
	40	40	40	40	40	40
	16	16	16	16	16	16
	1.8	1.8	1.8	1.8	1.8	1.8
	Derate linearly at 0.32 W/°C					
	Derate linearly at 0.32 W/°C					
	Derate linearly at 0.0144 W/°C					
	-65 to 150					
	235					

* 2N-Series types in accordance with JEDEC registration data format (JS-6, RDF-2) ♦ For p-n-p devices, voltage and current values are negative

2N6106-2N6111, 2N6288-2N6293, 2N6473-2N6476, 41500, 41501ELECTRICAL CHARACTERISTICS, At Case Temperature (T_C) = 25°C Unless Otherwise Specified

CHARACTERISTIC	TEST CONDITIONS [♦]				LIMITS				UNITS
	VOLTAGE V dc		CURRENT A dc		2N6292 2N6293 2N6106 [♦] 2N6107 [♦]		2N6290 2N6291 2N6108 [♦] 2N6109 [♦]		
	V _{CE}	V _{BE}	I _C	I _B	MIN.	MAX.	MIN.	MAX.	
I _{CER} (R _{BE} = 100Ω)	75				—	0.1	—	—	mA
	55				—	—	—	0.1	
(T _C = 150°C)	70				—	2	—	—	mA
	50				—	—	—	2	
I _{CEX}	75	-1.5			—	0.1	—	—	mA
	56	-1.5			—	—	—	0.1	
(T _C = 150°C)	70	-1.5			—	2	—	—	mA
	50	-1.5			—	—	—	2	
I _{CEO}	40			0	—	—	—	1	mA
	60			0	—	1	—	—	
I _{EBO}		-5	0		—	1	—	1	mA
V _{CEO(sus)}			0.1 ^a	0	70	—	50	—	V
V _{CER(sus)} (R _{BE} = 100Ω)			0.1		80	—	60	—	V
h _{FE}	4		2 ^a		30	150	—	—	
	4		2.5 ^a		—	—	30	150	
	4		7 ^a		2.3	—	2.3	—	
V _{BE} 2N6292, 2N6293 2N6290, 2N6291 All Types	4		2 ^a		—	1.5	—	—	V
	4		2.5 ^a		—	—	—	1.5	
	4		7 ^a		—	3	—	3	
V _{CE(sat)}			2 ^a	0.2	—	1	—	—	V
			2.5 ^a	0.25	—	—	—	1	
			7 ^a	3 ^a	—	3.5	—	3.5	
h _{fe} (f = 50 kHz)	4		0.5		20	—	20	—	
f _T 2N6290 - 2N6293 2N6106 - 2N6109	4		0.5		4	—	4	—	MHz
	-4		-0.5		10	—	10	—	
h _{fe} (f = 1 MHz) 2N6290 - 2N6293 2N6106 - 2N6109	4		0.5		4	—	4	—	
	-4		-0.5		10	—	10	—	
C _{obo} (f = 1 MHz, V _{CB} = 10 V)			0		—	250	—	250	pF
R _{θJC}					—	3.125	—	3.125	°C/W
R _{θJA}					—	70	—	70	

[♦]Pulsed; pulse duration = 300 μs, duty factor = 0.018.[♦]For p-n-p devices, voltage and current values are negative^{*}In accordance with JEDEC registration data format (JS-6 RDF-2).CAUTION: The sustaining voltages V_{CEO(sus)} and V_{CER(sus)} MUST NOT be measured on a curve tracer.

2N6106-2N6111, 2N6288-2N6293, 2N6473- 2N6476, 41500, 41501ELECTRICAL CHARACTERISTICS, At Case Temperature (T_C) = 25°C Unless Otherwise Specified

CHARACTERISTIC	TEST CONDITIONS [◆]				LIMITS						UNITS
	VOLTAGE V dc		CURRENT A dc		2N6474 2N6476 [◆]		2N6473 2N6475 [◆]		41500 41501 [◆]		
	V _{CE}	V _{BE}	I _C	I _B	MIN.	MAX.	MIN.	MAX.	MIN.	MAX.	
I _{CER} (R _{BE} = 100Ω)	30				—	—	—	—	—	0.25	mA
	120				—	0.1	—	—	—	—	
(T _C = 100°C)	100				—	—	—	0.1	—	—	mA
	120				—	2	—	—	—	—	
I _{CEX}	120	-1.5			—	0.1	—	—	—	—	mA
	100	-1.5			—	—	—	0.1	—	—	
(T _C = 100°C)	120	-1.5			—	2	—	—	—	—	mA
	100	-1.5			—	—	—	2	—	—	
I _{CEO}	60			0	—	1	—	—	—	—	mA
	50			0	—	—	—	1	—	—	
I _{EBO}		-5	0		—	1	—	1	—	—	mA
		-3	0		—	—	—	—	—	1	
V _{CEO(sus)}			0.1 ^a	0	120	—	100	—	25	—	V
V _{CER(sus)} (R _{BE} = 100Ω)			0.1		130	—	110	—	35	—	V
h _{FE}	4		1 ^a		—	—	—	—	25	—	
	4		1.5 ^a		15	150	15	150	—	—	
	2.5		4 ^a		2	—	2	—	—	—	
V _{BE}	4		1 ^a		—	—	—	—	—	1.5	V
	4		1.5 ^a		—	2	—	2	—	—	
	2.5		4 ^a		—	3.5	—	3.5	—	—	
V _{CE(sat)}			1 ^a	0.1	—	—	—	—	—	1	V
			1.5 ^a	0.15	—	1.2	—	1.2	—	—	
			4 ^a	2	—	2.5	—	2.5	—	—	
h _{fe} (f = 50 kHz)	4		0.5		20	—	20	—	20	—	
f _T 41500, 2N6473, 2N6474 2N6475, 2N6476	4		0.5		4	—	4	—	4	—	MHz
	-4		-0.5		5	—	5	—	—	—	
h _{fe} (f = 1 MHz) 41500, 2N6473, 2N6474 2N6475, 2N6476											
	4		0.5		4	—	4	—	4	—	
	-4		-0.5		5	—	5	—	—	—	
C _{obo} (f = 1 MHz, V _{CB} = 10 V)			0		—	250	—	250	—	250	pF
R _{θJC}					—	3.125	—	3.125	—	3.125	°C/W
R _{θJA}					—	70	—	70	—	70	

^aPulsed; pulse duration = 300 μs, duty factor = 0.018.[◆]For p-n-p devices, voltage and current values are negative.

*2N-series types in accordance with JEDEC registration data format (JS-6 RDF-2).

CAUTION: The sustaining voltage V_{CEO(sus)} and V_{CER(sus)} MUST NOT be measured on a curve tracer.

2N6106-2N6111, 2N6288-2N6293, 2N6473-2N6476, 41500, 41501

ELECTRICAL CHARACTERISTICS, At Case Temperature (T_C) = 25°C Unless Otherwise Specified

CHARACTERISTIC	SYMBOL	TEST CONDITIONS*				LIMITS				UNITS
		VOLTAGE V dc		CURRENT A dc		2N6288 2N6289		2N6110 [†] 2N6111 [†]		
		V _{CE}	V _{BE}	I _C	I _B	MIN.	MAX.	MIN.	MAX.	
Collector-Cutoff Current: With external base-to-emitter resistance (R _{BE}) = 100 Ω	I _{CER}	35				-	0.1	-	-0.1	mA
With (R _{BE}) = 100 Ω and T _C = 150°C		30				-	2	-	-2	
With base-emitter junction reverse-biased	I _{CEX}	37.5	-1.5			-	0.1	-	-0.1	mA
With base-emitter junction reverse-biased and T _C = 150°C		30	-1.5			-	2	-	-2	
With base open	I _{CEO}	20			0	-	1	-	-1	mA
Emitter-Cutoff Current	I _{EBO}		5	0		-	1	-	-1	mA
Collector-to-Emitter Sustaining Voltage: With base open	V _{CEO(sus)}			0.1 [‡]	0	30	-	-30	-	V
With external base-to emitter resistance (R _{BE}) = 100 Ω	V _{CER(sus)}			0.1		40	-	-40	-	V
DC Forward Current Transfer Ratio	h _{FE}	4 4		3 [§] 7 [§]		30 2.3	150 -	30 2.3	150 -	
Base-to-Emitter Voltage: 2N6288, 2N6289 All Types	V _{BE}	4 4		3 [§] 7 [§]		-	1.5 3	-	-	V
Collector-to-Emitter Saturation Voltage	V _{CE(sat)}			3 [§] 7 [§]	0.3 3	-	1 3.5	-	-1 -3.5	V
Common-Emitter, Small- Signal, Forward-Current Transfer Ratio: f = 50 kHz	h _{fe}	4			0.5	20	-	20	-	
Gain-Bandwidth Product: 2N6288-2N6289 2N6110-2N6111	f _T	4 -4			0.5 -0.5	4 -	-	-	10 -	MHz
Magnitude of Common- Emitter, Small-Signal Forward- Current Transfer Ratio: f = 1 MHz	h _{fe}	4 -4			0.5 -0.5	4 -	-	4 10	-	
Collector-to-Base Capacitance: f = 1 MHz, V _{CB} = 10 V	C _{obo}				0	-	250	-	250	pF
Thermal Resistance: Junction-to-Case	R _{θJC}					-	3.125	-	3.125	°C/W
Junction-to-Ambient	R _{θJA}					-	70	-	70	

[‡]Pulsed: Pulse duration = 300 μs, duty factor = 0.018.

[§]For p-n-p devices, voltage and current values are negative.

[†]In accordance with JEDEC registration data format (US-6 RDF-2).

CAUTION: The sustaining voltage V_{CER(sus)} MUST NOT be measured on a curve tracer.

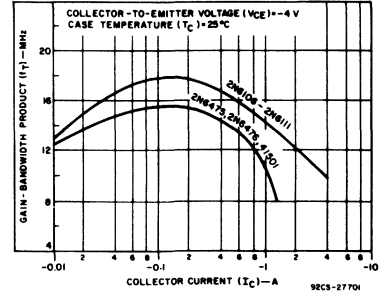


Fig. 2 - Typical gain-bandwidth product for 2N6106-2N6111, 2N6475, 2N6476, and 41501.

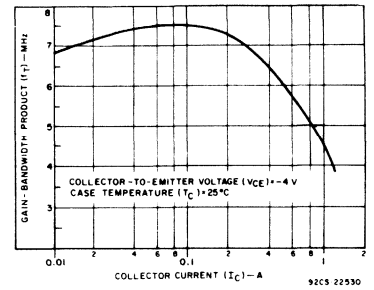


Fig. 3 - Typical gain-bandwidth product for 2N6473 and 2N6474.

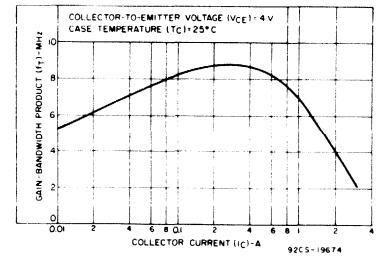


Fig. 4 - Typical gain-bandwidth product for 2N6288-2N6293, and 41500.

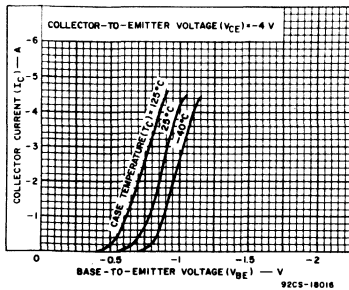


Fig. 5 - Typical transfer characteristics for 2N6106-2N6111.

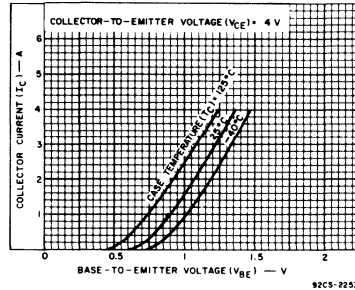


Fig. 6 - Typical transfer characteristics for 2N6473 and 2N6474.

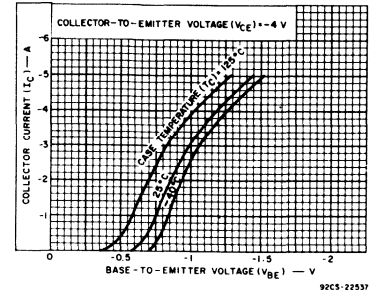


Fig. 7 - Typical transfer characteristics for 2N6475 and 2N6476.

2N6106-2N6111, 2N6288-2N6293, 2N6473-2N6476, 41500, 41501

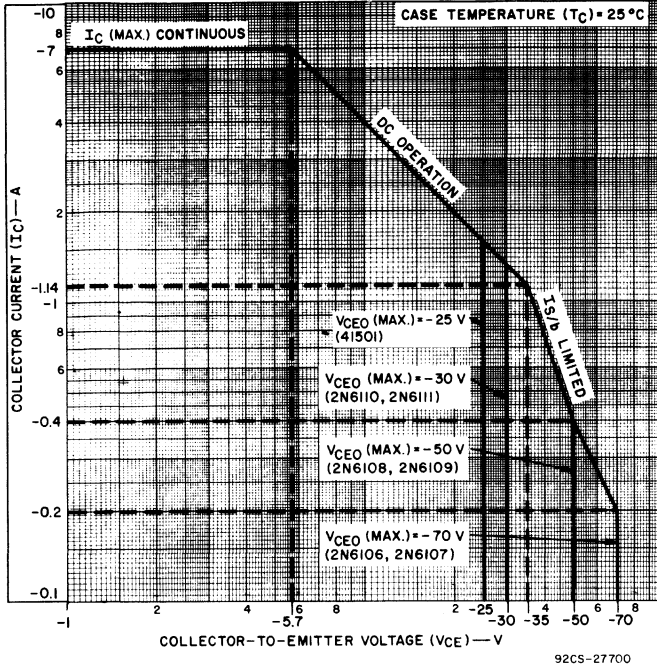


Fig. 8 - Maximum operating areas for 2N6106-2N6111 and 41501.

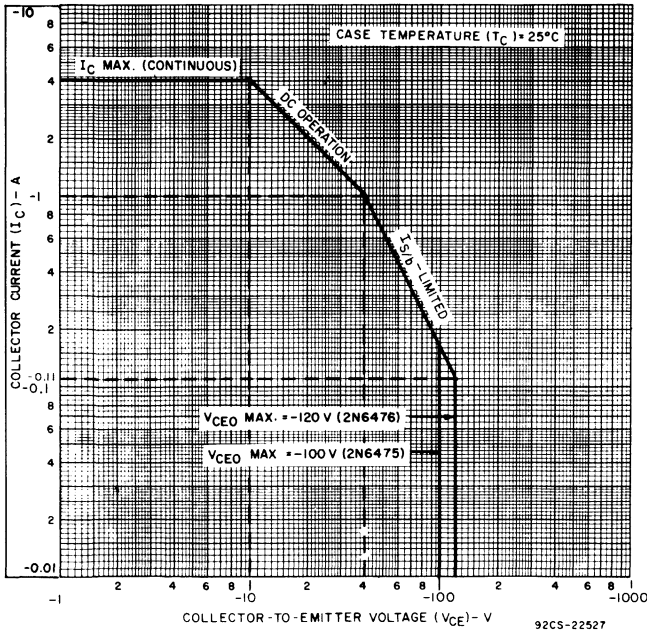


Fig. 11 - Maximum operating areas for 2N6475-2N6476.

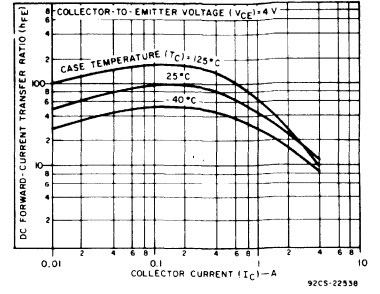


Fig. 9 - Typical dc beta characteristics for 2N6473 and 2N6474.

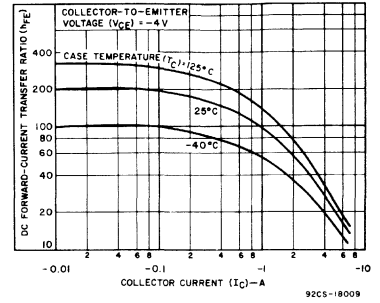


Fig. 10 - Typical dc beta characteristics for 2N6106-2N6111.

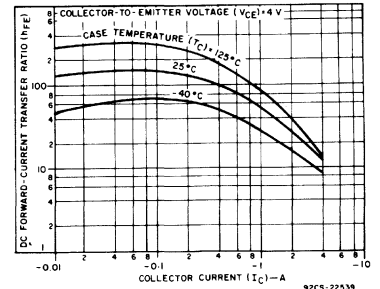


Fig. 12 - Typical dc beta characteristics for 2N6475 and 2N6476.

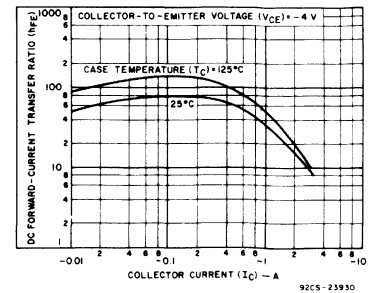


Fig. 13 - Typical dc beta characteristics for 41501.

2N6106-2N6111, 2N6288-2N6293, 2N6473-2N6476, 41500, 41501

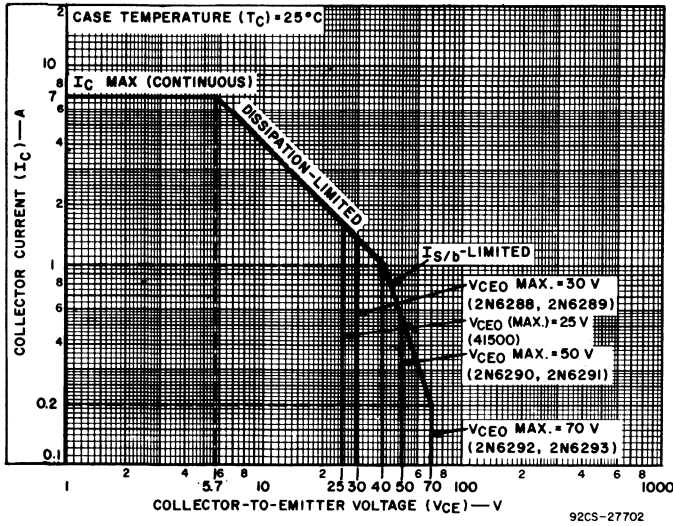


Fig. 14 - Maximum operating areas for 2N6288-2N6293 and 41500.

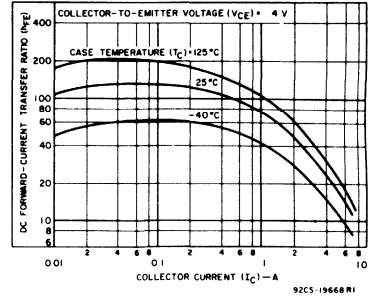


Fig. 15 - Typical dc beta characteristics for 2N6288-2N6293, and 41500.

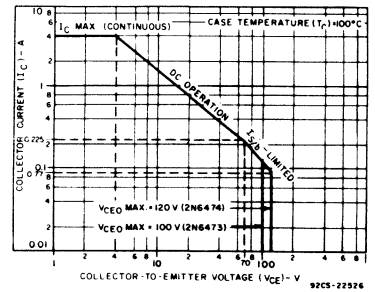


Fig. 16 - Maximum operating areas for 2N6473-2N6474.

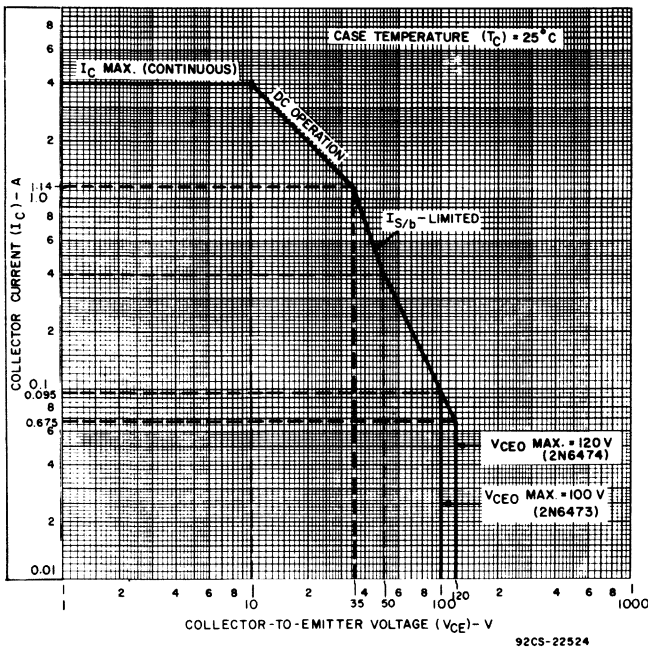


Fig. 17 - Maximum operating areas for 2N6473 and 2N6474.

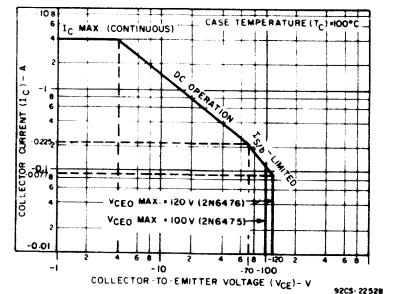


Fig. 18 - Maximum operating areas for 2N6475 and 2N6476.

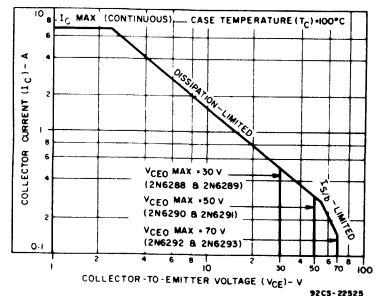


Fig. 19 - Maximum operating areas for 2N6288-2N6293.

2N6106-2N6111, 2N6288-2N6293, 2N6473-2N6476, 41500, 41501

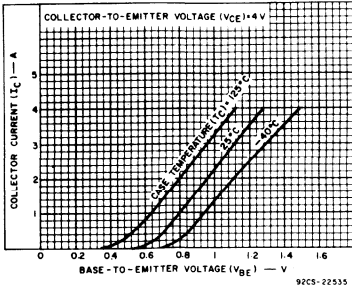


Fig. 20 - Typical transfer characteristics for 2N6288-2N6293, and 41500.

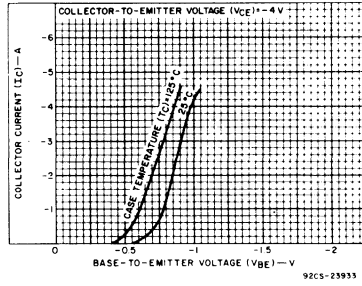


Fig. 21 - Typical transfer characteristics for 41501.

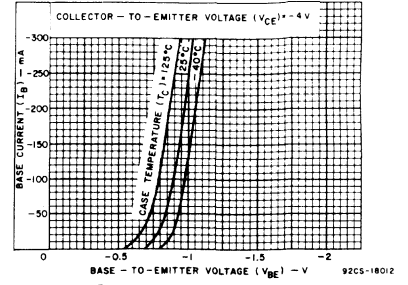


Fig. 22 - Typical input characteristics for 2N6106-2N6111, 2N6475, and 2N6476.

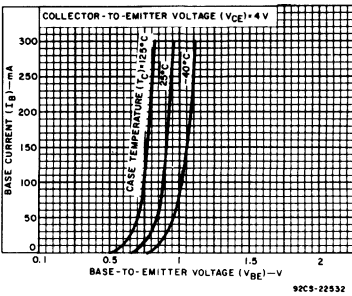


Fig. 23 - Typical input characteristics for 2N6473 and 2N6474.

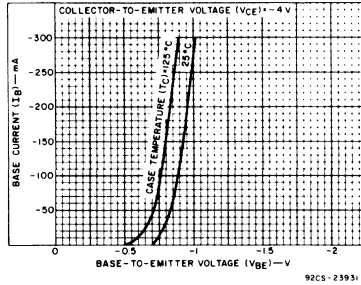


Fig. 24 - Typical input characteristics for 41501.

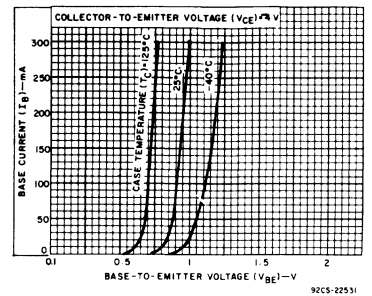


Fig. 25 - Typical input characteristics for 2N6288-2N6293.

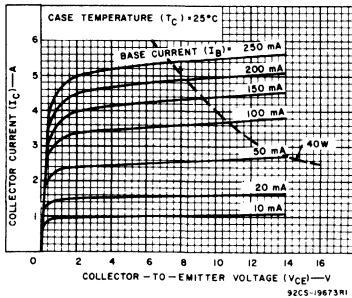


Fig. 26 - Typical output characteristics for 2N6288-2N6293, and 41500.

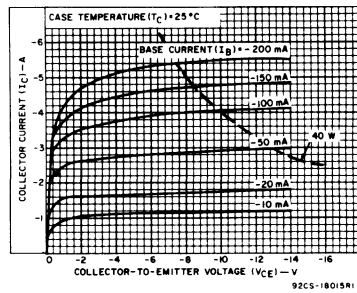


Fig. 27 - Typical output characteristics for 2N6106-2N6111.

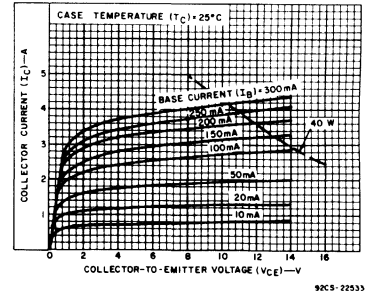


Fig. 28 - Typical output characteristics for 2N6473 and 2N6474.

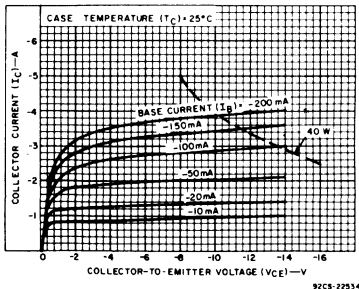


Fig. 29 - Typical output characteristics for 2N6475 and 2N6476.

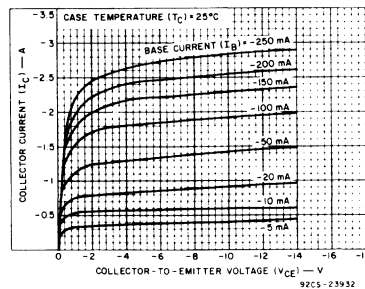


Fig. 30 - Typical output characteristics for 41501.

2N6211-2N6214

High-Voltage, Medium-Power Silicon P-N-P Transistors

For Switching and Amplifier Applications
In Military, Industrial, and Commercial Equipment

RCA types 2N6211, 2N6212, 2N6213, and 2N6214* are epitaxial silicon p-n-p transistors with high breakdown-voltage ratings and fast switching speeds. They are supplied in the popular JEDEC TO-66 package; they differ in breakdown-voltage ratings and leakage-current values.

* Formerly RCA Dev. Nos. TA7719, TA7410, TA8330, and TA8331, respectively.

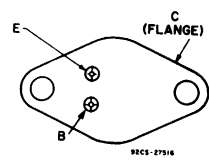
Applications:

- Power-Switching Circuits
- Switching Regulators
- Converters
- Inverters
- High-Fidelity Amplifiers

Features:

- High voltage ratings:
 - $V_{CE(sus)}$ = -400 V max. (2N6214)
 - = -350 V max. (2N6213)
 - = -300 V max. (2N6212)
 - = -225 V max. (2N6211)
- Large safe-operating area
- Complements to 2N3585 transistor family
- Thermal-cycling rating

TERMINAL DESIGNATIONS



JEDEC TO-66

MAXIMUM RATINGS, Absolute-Maximum Values:

	2N6211	2N6212	2N6213	2N6214		
*COLLECTOR-TO-BASE VOLTAGE	V_{CBO}	-275	-350	-400	-450	V
COLLECTOR-TO-EMITTER SUSTAINING VOLTAGE:						
With base open	$V_{CEO(sus)}$	-225	-300	-350	-400	V
With external base-to-emitter resistance (R_{BE}) = 50 Ω	$V_{CER(sus)}$	-250	-325	-375	-425	V
* With base-emitter junction reverse-biased (V_{BE} = 1.5 V)	$V_{CEX(sus)}$	-275	-350	-400	-450	V
*EMITTER-TO-BASE VOLTAGE	V_{EBO}	-6	-6	-6	-6	V
*COLLECTOR CURRENT (Continuous)	I_C	-2	-2	-2	-2	A
*BASE CURRENT (Continuous)	I_B	-1	-1	-1	-1	A
TRANSISTOR DISSIPATION:	P_T					
At case temperatures up to 100°C and V_{CE} up to 50 V		20	20	20	20	W
At case temperatures up to 25°C and V_{CE} up to 40 V		35	35	35	35	W
At case temperatures up to 25°C and V_{CE} above 40 V						
At case temperatures above 25°C						
Derate linearly to 200°C						
*TEMPERATURE RANGE:						
Storage & Operating (Junction)						-65 to 200 °C
*LEAD TEMPERATURE (During Soldering):						
At distance \geq 1/32 in. (0.8 mm) from case for 10s max.						230 °C

See Fig. 1

Derate linearly to 200°C

*In accordance with JEDEC registration data format (JS-6 RDF-1)

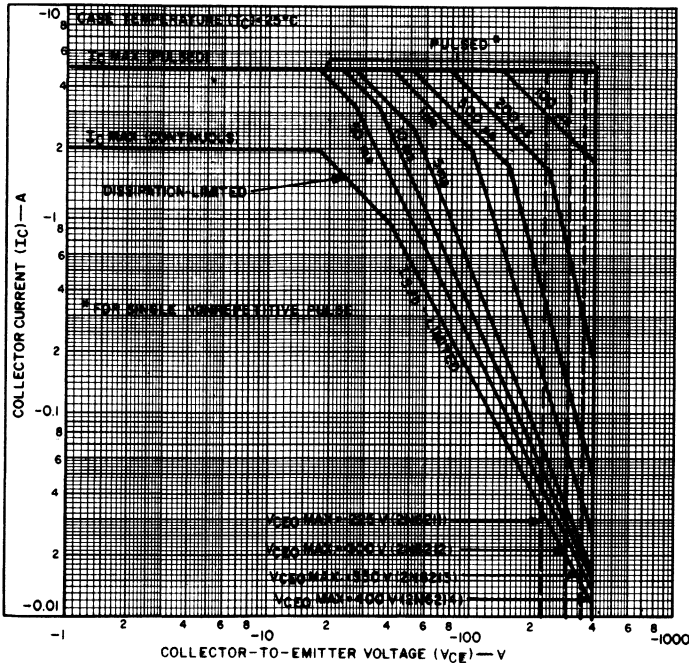


Fig. 1 - Maximum operating areas for all types.

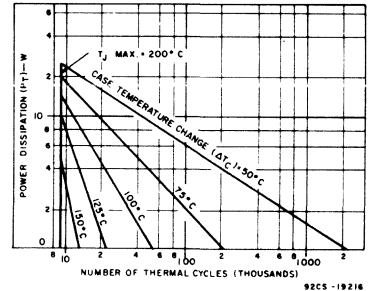


Fig. 2 - Thermal-cycling rating chart for all types.

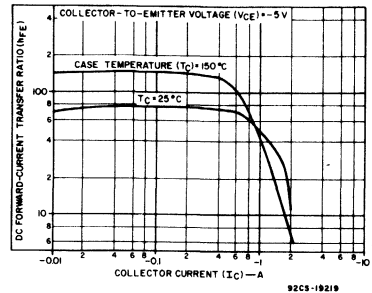


Fig. 3 - Typical dc beta characteristic for all types.

2N6211-2N6214

ELECTRICAL CHARACTERISTICS, At Case Temperature (T_C) = 25°C Unless Otherwise Specified

CHARACTERISTIC	SYMBOL	TEST CONDITIONS				LIMITS								UNITS
		Voltage V dc		Current A dc		2N6211		2N6212		2N6213		2N6214		
		V_{CE}	V_{BE}	I_C	I_B	Min.	Max.	Min.	Max.	Min.	Max.	Min.	Max.	
Collector-Cutoff Current: With base open	I_{CEO}	-150			0	-	-5	-	-5	-	-5	-	-5	mA
With base-emitter junction reverse-biased	I_{CEV}	-250	1.5			-	-0.5	-	-	-	-	-	-	
		-315	1.5			-	-	-	-0.5	-	-	-	-	
		-360	1.5			-	-	-	-	-	-0.5	-	-	
With base-emitter junction reverse biased and $T_C = 100^\circ\text{C}$		-410	1.5			-	-	-	-	-	-	-	-1	
		-250	1.5			-	-5	-	-	-	-	-	-	
		-315	1.5			-	-	-	-5	-	-	-	-	
		-360	1.5			-	-	-	-	-	-5	-	-	
		-410	1.5			-	-	-	-	-	-	-	-10	
Emitter-Cutoff Current	I_{EBO}		6		0	-	1	-	-0.5	-	-0.5	-	-0.5	mA
DC Forward Current Transfer Ratio	h_{FE}	-2.8			-1 ^a	10	100							
		-3.2			-1 ^a			10	100					
		-4			-1 ^a					10	100			
		-5			-1 ^a							10	100	
Collector to Emitter Sustaining Voltage With base open	$V_{CEO(sust)}$			-0.2 ^a	0	-225		-300		-350		-400	V	
With external base to emitter resistance (R_{BE}) = 50 Ω	$V_{CER(sust)}$			-0.2 ^a		250		-325		-375		-425		
With base emitter junction reverse biased and external base to emitter resistance (R_{BE}) 50 Ω	$V_{CEX(sust)}$		15	-0.2 ^a		275		350		400		-450		
Emitter to Base Voltage	V_{EBO}				0.5 mA 1 mA	6		6		-6		-6	V	
Emitter to Base Saturation Voltage	$V_{BE(sat)}$			-1 ^a	0.125		1.4		-1.4		-1.4		-1.4	V
Collector to Emitter Saturation Voltage	$V_{CE(sat)}$			-1 ^a	0.125		1.4		1.6		-2		-2.5	V
Output Capacitance (f = 1 MHz)	C_{obo}	-10 (V_{CB})					220		220		220		220	pF
Second Breakdown Collector Current (Base forward-biased)	$I_{S/b}$	-40				0.875		-0.875		-0.875		-0.875		A
Magnitude of Common Emitter, Small Signal, Short Circuit, Forward Current Transfer Ratio (f = 5 MHz)	$ h_{fe} $	-10			-0.2	4		4		4		4		
Saturated Switching Times	t_r	$V_{CC} = -200\text{ V}$		-1	$I_{B1} \& I_{B2} = -0.125$	0.6		0.6		0.6		0.6		μs
Storage time	t_s	$V_{CC} = -200\text{ V}$		-1	$I_{B1} \& I_{B2} = -0.125$		2.5		2.5		2.5		2.5	
Fall time	t_f	$V_{CC} = -200\text{ V}$		-1	$I_{B1} \& I_{B2} = -0.125$		0.6		0.6		0.6		0.6	
Thermal Resistance (Junction-to-case)	$R_{\theta JC}$	-10			-1		5		5		5		5	$^\circ\text{C/W}$

¹ In accordance with JEDEC registration data format JS-6 RDF-1.

^a Pulsed, pulse duration = 300 μs ; duty factor $\leq 2\%$.

2N6211-2N6214

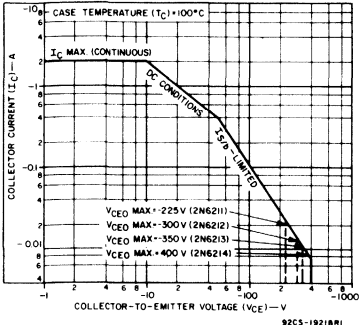


Fig. 4 - Maximum operating areas for all types.

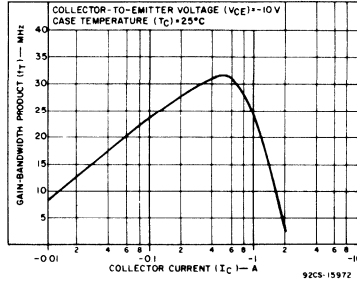


Fig. 5 - Typical gain-bandwidth product for all types.

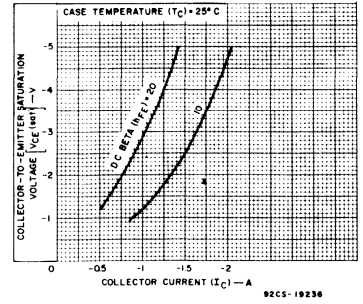


Fig. 6 - Typical saturation-voltage characteristics for all types.

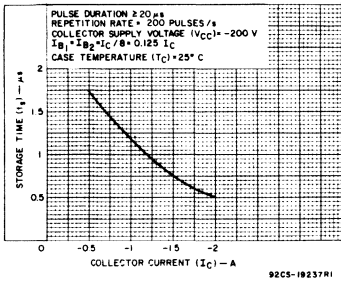


Fig. 7 - Typical storage-time characteristic for all types.

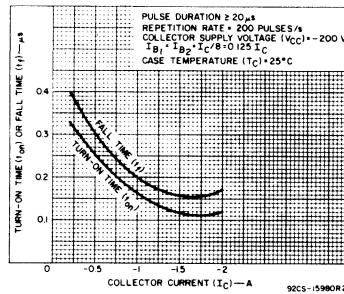


Fig. 8 - Typical turn-on time and fall-time characteristics for all types.

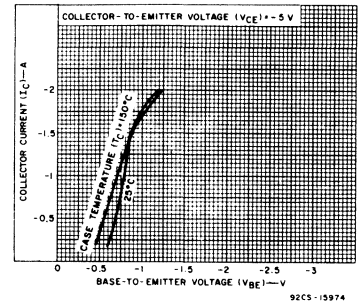


Fig. 9 - Typical transfer characteristics for all types.

2N6246, 2N6247, 2N6248, 2N6469, 2N6470, 2N6471, 2N6472

Silicon N-P-N and P-N-P Epitaxial-Base High-Power Transistors

General-Purpose Types for Switching and Linear-Amplifier Applications

RCA-2N6246, 2N6247, 2N6248, ar.J 2N6469 are epitaxial-base silicon p-n-p transistors featuring high gain at high current. RCA-2N6470, 2N6471, and 2N6472 are epitaxial-base silicon n-p-n transistors. They may be used as complements to the 2N6469, 2N6246, and 2N6247, respectively. All of these devices have a dissipation capability of 125 watts at case temperatures up to 25°C. They differ in voltage ratings

and in the currents at which the parameters are controlled. All are supplied in the JEDEC TO-3 package.

- ▲ Formerly RCA Dev. Nos. TA7281, TA7280, TA7279, and TA8724, respectively.
- Formerly RCA Dev. Nos. TA8726, TA8443, and TA8442, respectively.

Features:

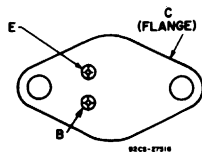
- High dissipation capability: 125 W at 25°C
- Low saturation voltages
- Maximum safe-area-of-operation curves
- Hermetically sealed JEDEC TO-3 package
- High gain at high current
- Thermal-cycling rating curve

Maximum Ratings, Absolute-Maximum Values:

	N.P.N P.N.P	2N6470	2N6471	2N6472	V	
		2N6469♦	2N6246♦	2N6247♦		2N6248♦
*COLLECTOR-TO-BASE VOLTAGE	V _{CB0}	50	70	90	110	V
COLLECTOR-TO-EMITTER VOLTAGE						
• With external base-to-emitter resistance (R _{BE}) = 100 Ω	V _{CER}	50	70	90	110	V
With base open	V _{CEO}	40	60	80	100	V
*EMITTER-TO-BASE VOLTAGE	V _{EBO}	5	5	5	5	V
*CONTINUOUS COLLECTOR CURRENT	I _C	15	15	15	10	A
*CONTINUOUS BASE CURRENT	I _B	5	5	5	5	A
*TRANSISTOR DISSIPATION:	P _T					
At case temperatures up to 25°C		125	125	125	125	W
At case temperatures above 25°C		← Derate linearly 200 °C →				
*TEMPERATURE RANGE:						
Storage & Operating (Junction)		← -65 to +200 →				°C
*PIN TEMPERATURE (During Soldering):						
At distances ≥ 1/32" (0.8 mm) from seating plane for 10 s max.		← +235 →				°C

* In accordance with JEDEC registration data format (JES 6 RDF-2).
♦ For p-n-p devices, voltage and current values are negative.

TERMINAL DESIGNATIONS



JEDEC TO-3

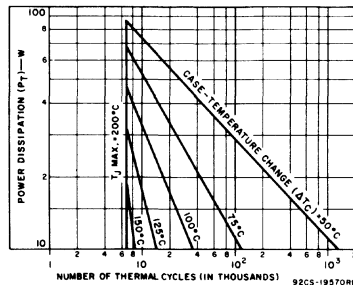


Fig. 1 - Thermal-cycling rating chart for all types.

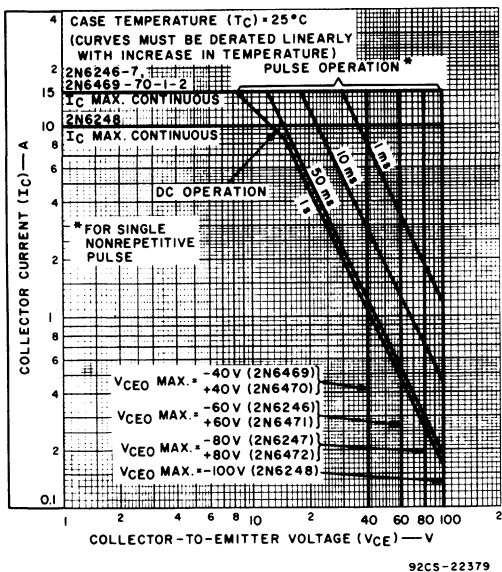


Fig. 3 - Maximum operating areas for all types. ♦

♦ For p-n-p devices, voltage and current values are negative.

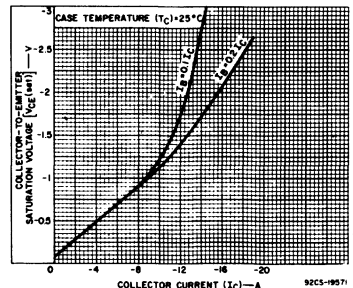


Fig. 2 - Typical collector-to-emitter saturation-voltage characteristics for 2N6246, 2N6247, 2N6248, and 2N6469.

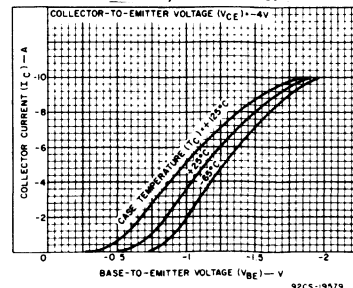


Fig. 4 - Typical transfer characteristics for 2N6246, 2N6247, 2N6248, and 2N6469.

2N6246, 2N6247, 2N6248, 2N6469, 2N6470, 2N6471, 2N6472

ELECTRICAL CHARACTERISTICS FOR N-P-N TYPES, At case temperature (T_C) = 25°C unless otherwise specified

CHARACTERISTIC	SYMBOL	TEST CONDITIONS		LIMITS						UNITS	
		VOLT-AGE V dc	CUR-RENT A dc	2N6470		2N6471		2N6472			
		V_{CE}	I_C	I_B	Min.	Max.	Min.	Max.	Min.		Max.
Collector-Cutoff Current: With external base-emitter resistance (R_{BE}) = 100 Ω	I_{CER}	35			500	—	—	—	—	—	μA
With base-emitter junction reverse-biased $V_{BE} = -1.5$ V	I_{CEX}	45			500	—	—	—	—	—	μA
With reverse bias, $V_{BE} = -1.5$ V, and $T_C = 150^\circ C$		65			—	—	500	—	—	—	μA
		85			—	—	—	—	500	—	μA
With base open	I_{CEO}	40			5	—	—	—	—	—	mA
		60			—	—	5	—	—	—	mA
		80			—	—	—	—	5	—	mA
Emitter-Cutoff Current: $V_{BE} = -5$ V	I_{EBO}		0		—	1	—	—	—	—	mA
			0		—	—	—	1	—	—	mA
			0		—	—	—	—	1	—	mA
DC Forward-Current Transfer Ratio	h_{FE}	4	5 ^a	20	150	20	150	20	150		
		4	15 ^a	5	—	5	—	5	—		
Collector-to-Emitter Sustaining Voltage: With base open	$V_{CEO(sus)}$		0.2	0	40 ^b	—	60 ^b	—	80 ^b	—	V
With external base-emitter resistance (R_{BE}) = 100 Ω	$V_{CER(sus)}$		0.2		50 ^b	—	70 ^b	—	90 ^b	—	V
Base-to-Emitter Voltage	V_{BE}	4	5 ^a		1.3	—	1.3	—	1.3		V
		4	15 ^a		3.5	—	3.5	—	3.5		V
Collector-to-Emitter Saturation Voltage	$V_{CE(sat)}$		5 ^a	0.5	—	1.3	—	1.3	—	1.3	V
			15 ^a	5	—	3.5	—	3.5	—	3.5	V
Magnitude of Common-Emitter Small-Signal Short-Circuit Forward-Current Transfer Ratio: f = 1 MHz	$ h_{fe} $	4	1		5	—	5	—	5	—	
Common-Emitter, Small-Signal, Short-Circuit, Forward-Current Transfer Ratio: f = 1 kHz	h_{fe}	4	1		25	—	25	—	25	—	
Thermal Resistance: Junction-to-case	$R_{\theta JC}$				—	1.4	—	1.4	—	1.4	$^\circ C/W$

^a In accordance with JEDEC registration data format (JS-6 RDF-2).

^b CAUTION: Sustaining voltages $V_{CEO(sus)}$ and $V_{CER(sus)}$ MUST NOT be measured on a curve tracer.

^a Pulsed; pulse duration = 300 μs , duty factor = 1.8%.

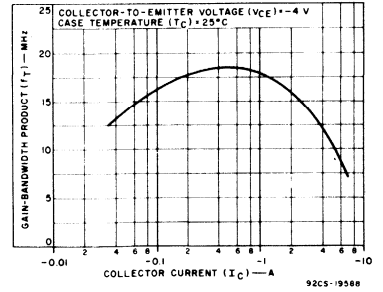


Fig. 5 - Typical gain-bandwidth product as a function of collector current for 2N6246, 2N6247, 2N6248, and 2N6469.

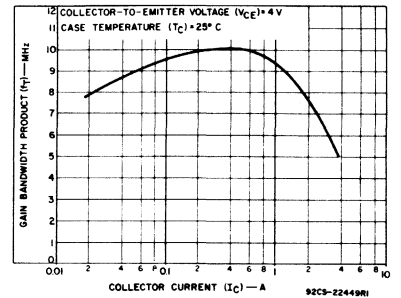


Fig. 6 - Typical gain-bandwidth product as a function of collector current for 2N6470, 2N6471, and 2N6472.

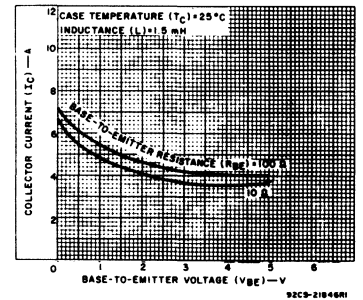


Fig. 7 - Minimum reverse-bias second-breakdown characteristics for all types. (Values for p-n-p types are negative).

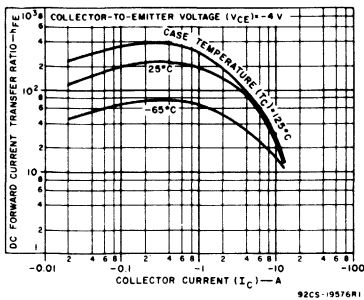


Fig. 8 - Typical dc beta characteristics for 2N6246, 2N6247, and 2N6469.

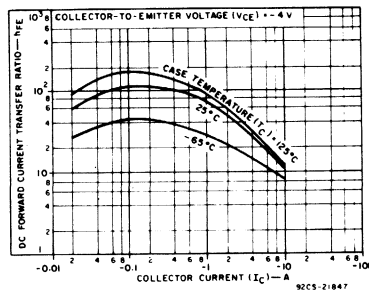


Fig. 9 - Typical dc beta characteristics for 2N6248.

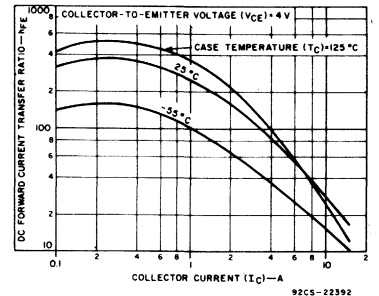


Fig. 10 - Typical dc beta characteristics for 2N6470, 2N6471, and 2N6472.

2N6246, 2N6247, 2N6248, 2N6469, 2N6470, 2N6471, 2N6472

ELECTRICAL CHARACTERISTICS FOR P-N-P TYPES, At case temperature (T_C) = 25°C unless otherwise specified

SYMBOL	TEST CONDITIONS				LIMITS				TEST CONDITIONS				LIMITS				UNITS
	VOLTAGE V dc		CURRENT A dc		2N6469		2N6246		VOLTAGE V dc		CURRENT A dc		2N6247		2N6248		
	V_{CE}	V_{BE}	I_C	I_B	Min.	Max.	Min.	Max.	V_{CE}	V_{BE}	I_C	I_B	Min.	Max.	Min.	Max.	
I_{CER} (R_{BE}) = 100 Ω	-35 -55				-	-200	-	-	-75 -95				-	-200	-	-	μA
I_{CEX}	-45 -65	1.5 1.5			-	-200	-	-	-85 -100	1.5 1.5			-	-200	-	-	μA
$T_C = 150^\circ C$	-45 -55	1.5 1.5			-	-5	-	-	-70 -90	1.5 1.5			-	-5	-	-	mA
I_{CEO}	-20 -30		0 0		-	-1	-	-	-40 -50		0 0		-	-1	-	-	mA
I_{EBO}		5		0	-	-5	-	-	5		0		-	-1	-	-	mA
h_{FE}	-4 -4 4	-5 ^a 7 ^a -15 ^a			20 5	150	-	20 5	-4 -4 -4	-5 ^a -6 ^a -10 ^a -15 ^a			20 5	100	5	20 5	
$V_{CEO(sus)}$			0.2	0	40 ^b	-	60 ^b	-			-0.2	0	-80 ^b	-	-100 ^b	-	V
$V_{CER(sus)}$			-0.2		-50 ^b	-	-70 ^b	-			-0.2		-90 ^b	-	-110 ^b	-	V
V_{BE}	-4 -4	-15 ^a 7 ^a			-	-3.5	-	-	-4 -4	-6 ^a -5 ^a			-	-1.8	-	-	-1.8
$V_{CE(sat)}$		-5 ^a -7 ^a -15 ^a -15 ^a	-0.5 -0.7 -5 3		-	-1.3	-	-	-1.3	-5 ^a -6 ^a -15 ^a -10 ^a	-0.5 -0.6 -4 -2		-	-1.3	-	-	-1.3 -3.5 -3.5
$ h_{fe} $ $f = 2 \text{ MHz}$	-4	-1			5	-	5	-	-4	-1			5	-	5	-	
h_{fe} $f = 1 \text{ kHz}$	-4	-1			25	-	25	-	-4	-1			25	-	25	-	
$R_{\theta JC}$					-	1.4	-	1.4					-	1.4	-	1.4	$^\circ C/W$

^a In accordance with JEDEC registration data format (JS 6 RDF-2)

^b CAUTION: CAUTION: Sustaining voltages $V_{CEO(sus)}$ and $V_{CER(sus)}$ MUST NOT be measured on a curve tracer.

^a Pulsed; pulse duration = 300 μs , duty factor = 1.8%.

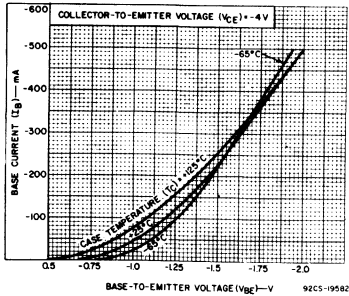


Fig. 11 - Typical input characteristics for 2N6246, 2N6247, and 2N6449.

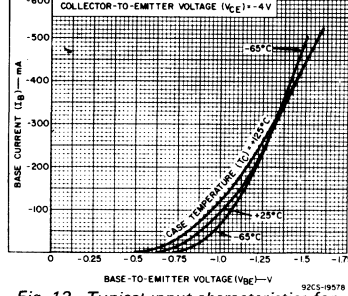


Fig. 12 - Typical input characteristics for 2N6248.

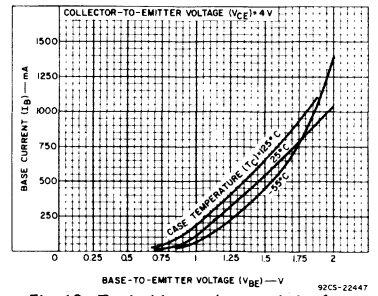


Fig. 13 - Typical input characteristics for 2N6470, 2N6471, and 2N6472.

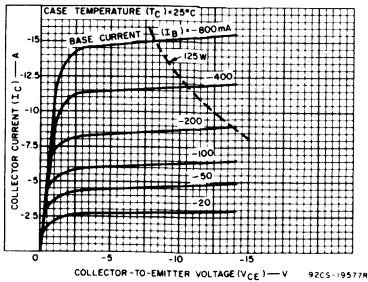


Fig. 14 - Typical output characteristics for 2N6246, 2N6247, and 2N6469.

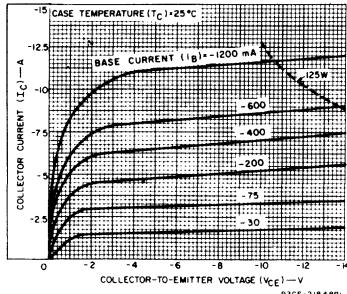


Fig. 15 - Typical output characteristics for 2N6248.

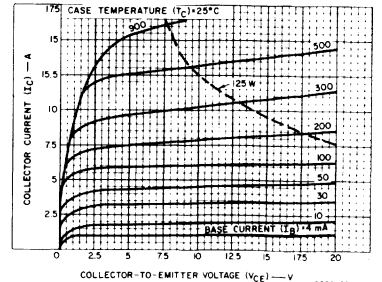


Fig. 16 - Typical output characteristics for 2N6470, 2N6471, and 2N6472.

2N6246, 2N6247, 2N6248, 2N6469, 2N6470, 2N6471, 2N6472

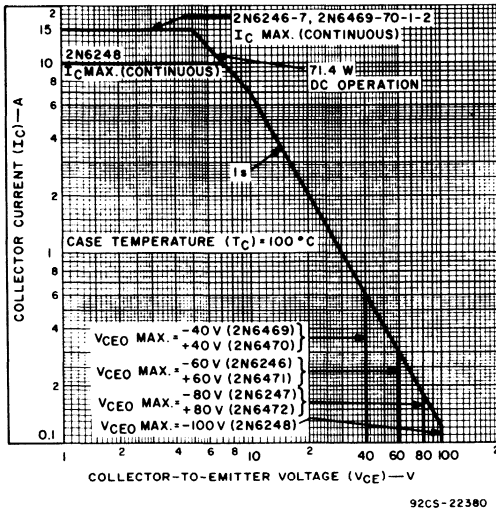


Fig. 17 - Maximum operating areas for all types. ♦

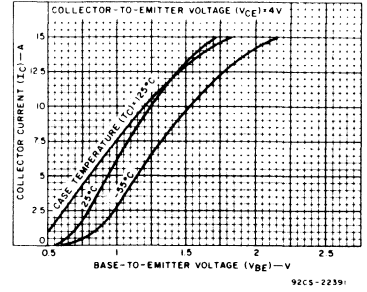


Fig. 18 - Typical transfer characteristics for 2N6470, 2N6471, and 2N6472.

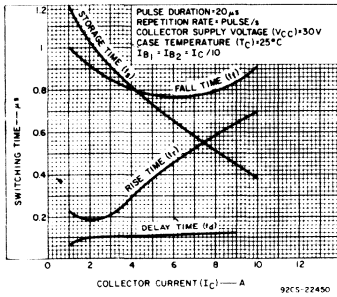


Fig. 19 - Typical saturated switching characteristics for 2N6470, 2N6471, and 2N6472.

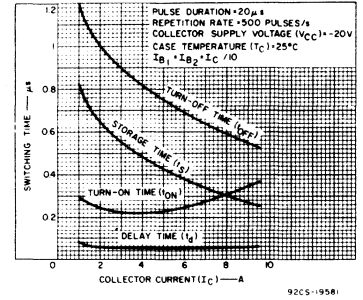


Fig. 20 - Typical saturated switching characteristics for 2N6246, 2N6247, 2N6248, and 2N6469.

♦ For p-n-p devices, voltage and current values are negative.

2N6249, 2N6250, 2N6251

450-V, 30-A, 175-W Silicon N-P-N Switching Transistors

For Switching Applications in Industrial and Commercial Equipment

RCA-2N6269, 2N6250 and 2N6251 are multiple epitaxial silicon n-p-n power transistors utilizing a multiple-emitter-site structure. Multiple-epitaxial construction maximizes the volt-ampere characteristic of the device and provides fast switching speeds. Multiple-emitter-site design assures uniform current flow throughout the structure, which produces a high I_S/b and a large safe-operation area.

These devices use the popular JEDEC TO-3/TO-204MA package; they differ mainly in voltage ratings, leakage-current limits, and $V_{CE}(sat)$ ratings.

The exceptional second-breakdown capabilities and high voltage breakdown ratings make

these transistors especially suitable for off-line inverters, switching regulators motor controls, and deflection circuit applications.

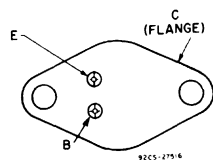
The high gain and high E_S/b energy-handling capability of the 2N6249 make it an excellent choice for motor-control applications in which large winding inductances are encountered and high surge currents are required to start the motor.

The high breakdown voltages, low saturation voltages, and fast-switching capability of the 2N6250 and 2N6251 make them especially suitable for inverter circuits operating directly off the rectified 115-V power line or a bridge configuration operating from the rectified 220-V line.

Features:

- High voltage ratings:
 $V_{CBO} = 450\text{ V}$ (2N6251)
 375 V (2N6250)
 300 V (2N6249)
- High dissipation rating:
 $P_T = 175\text{ W}$
- Low saturation voltages
- Maximum safe-area-of-operation curves

TERMINAL DESIGNATIONS



JEDEC TO3/TO-204MA

MAXIMUM RATINGS, Absolute-Maximum Values:

	2N6249	2N6250	2N6251	
* V_{CBO}	300	375	450	V
$V_{CEO}(sus)$	200	275	350	V
* $V_{CEX}(sus)$ ($V_{BE} = 0\text{ V}$)	225	300	375	V
$V_{CER}(sus)$ ($R_{BE} \leq 50\ \Omega$)	225	300	375	V
* V_{EBO}	6	6	6	V
* I_C	10	10	10	A
I_{CM}	30	30	30	A
* I_B	10	10	10	A
* P_T	175	175	175	W
At T_C up to 25°C and V_{CE} up to 30 V				
At T_C up to 25°C and V_{CE} above 30 V				
* $T_J + T_{stg}$	Derate linearly at 1			$^\circ\text{C/W}$
* T_L	-65 to +200			$^\circ\text{C}$
At distances $\geq 1/32$ in. (0.8 mm) from case for 10 s max.				
			230	$^\circ\text{C}$

* 2N-Series types in accordance with JEDEC registration data format (JS-6, RDF-1).

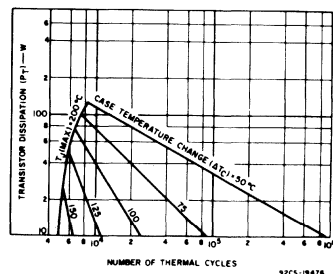


Fig. 1 - Thermal-cycle rating chart for all types.

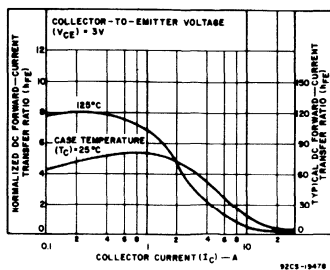


Fig. 2 - Typical normalized dc beta characteristics for all types.

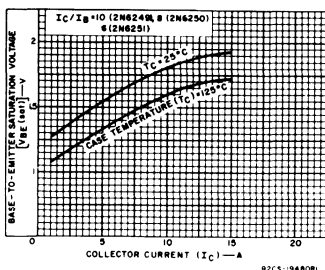


Fig. 3 - Typical base-to-emitter saturation voltage characteristics for all types.

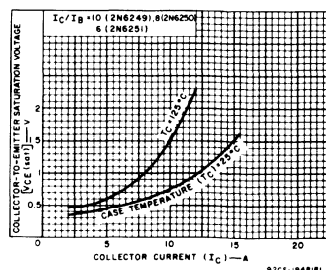


Fig. 4 - Typical collector-to-emitter saturation voltage characteristics for all types.

2N6249, 2N6250, 2N6251

ELECTRICAL CHARACTERISTICS, At Case Temperature (T_C) = 25°C Unless Otherwise Specified

CHARACTERISTIC	TEST CONDITIONS			LIMITS									UNITS
	DC VOLTAGE (V)	DC CURRENT (A)	I_B	2N6249			2N6250			2N6251			
				MIN.	TYP.	MAX.	MIN.	TYP.	MAX.	MIN.	TYP.	MAX.	
	V_{CE}	I_C	I_B										
I_{CEO}	150 225 300		0 0 0	- - -	- - -	5	- - -	- - -	5	- - -	- - -	5	mA
* I_{CEV} $V_{BE} = -1.5$	225 300 375 450				5			5			5		
* I_{CEV} $V_{BE} = -1.5$ $T_C = 125^\circ C$	225 300 375 450				10			10			10		
* I_{EBO} $V_{BE} = -6$					1			1			1	mA	
* $V_{CEO(sus)}$		0.2		200 ^b	-	-	275 ^b	-	-	350 ^b	-		-
* $V_{CER(sus)}$ $R_{BE} = 50 \Omega$		0.2		225 ^b	-	-	300 ^b	-	-	375 ^b	-	-	
* V_{EBO} $I_E = 1 \text{ mA}$				6	-	-	6	-	-	6	-	-	V
* h_{FE}	3 3 3 4	10 ^a 10 ^a 10 ^a 10 ^a		10	-	50	-	-	50	-	-	50	
* $V_{BE(sat)}$		10 ^a 10 ^a 10 ^a 16 ^a	1 1.25 1.67 3.2	-	-	2.25	-	-	2.25	-	-	2.25	V
* $V_{CE(sat)}$		10 ^a 10 ^a 10 ^a 16 ^a	1 1.25 1.67 3.2	-	-	1.5	-	-	1.5	-	-	1.5	
* $ h_{fe} $ $f = 1 \text{ MHz}$	10	1		2.5	8	-	2.5	8	-	2.5	8	-	A
* I_S/b $t_p = 1 \text{ s nonrep.}$	30			5.8	-	-	5.8	-	-	5.8	-	-	
* E_S/b $V_{BE} = -4$ $R_B = 50 \Omega$ $L = 50 \mu H$		10 ^c		2.5	-	-	2.5	-	-	2.5	-	-	mJ
* t_r $V_{CC} = 200 \text{ V}$ $I_{B1} = -I_{B2}$	10 10 10	1 1.25 1.67		-	0.8	2	-	-	0.8	2	-	-	
* t_s $V_{CC} = 200 \text{ V}$ $I_{B1} = -I_{B2}$	10 10 10	1 1.25 1.67		-	1.8	3.5	-	-	1.8	3.5	-	-	μs
* t_f $V_{CC} = 200 \text{ V}$ $I_{B1} = -I_{B2}$	10 10 10	1 1.25 1.67		-	0.5	1	-	-	0.5	1	-	-	
* $R_{\theta JC}$	10	5		-	-	1	-	-	1	-	-	1	$^\circ C/W$

* 2N-Series types in accordance with JEDEC registration data format (JS-6 RDF-1).
 a Pulsed; pulse duration $\leq 300 \mu s$, duty factor = 2%.
 b CAUTION: The sustaining voltages $V_{CEO(sus)}$ and $V_{CER(sus)}$ MUST NOT be measured on a curve tracer.

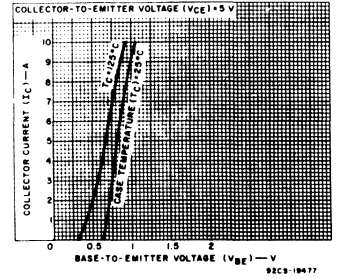


Fig. 5 - Typical transfer characteristics for all types.

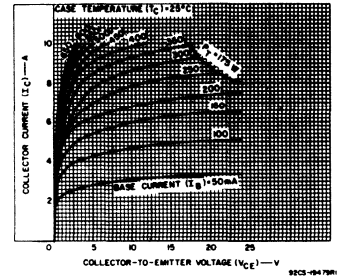


Fig. 6 - Typical output characteristics for all types.

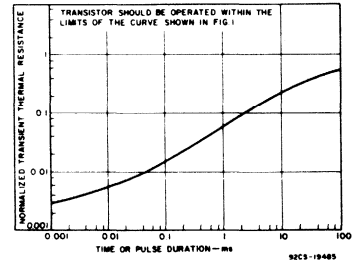


Fig. 7 - Typical thermal response characteristics for all types.

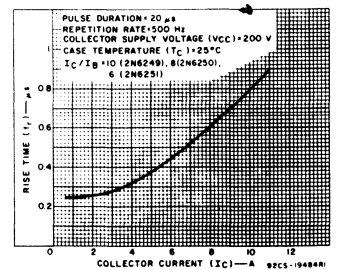


Fig. 8 - Typical rise-time characteristics for all types.

2N6249, 2N6250, 2N6251

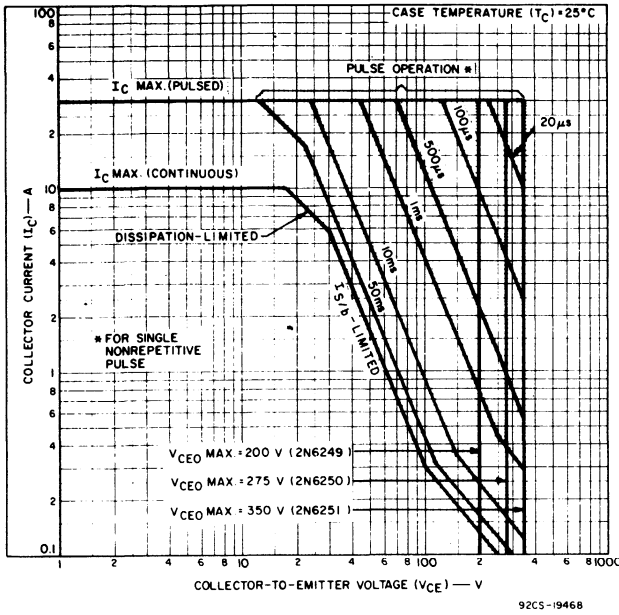


Fig. 9 - Maximum operating areas for all types at $T_C = 25^\circ\text{C}$.

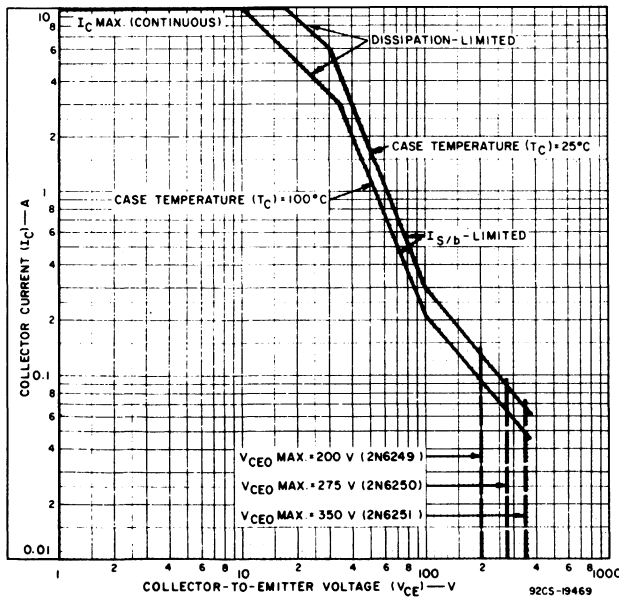


Fig. 10 - Maximum operating areas for all types at $T_C = 100^\circ\text{C}$.

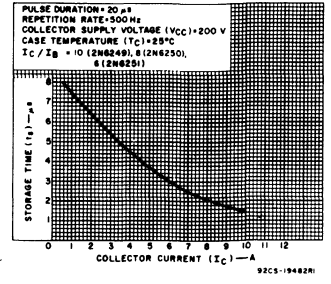


Fig. 11 - Typical storage-time characteristics for all types (with constant forced gain).

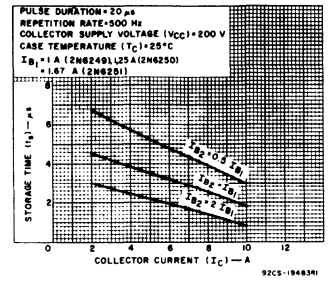


Fig. 12 - Typical storage-time characteristics for all types (with constant base drive).

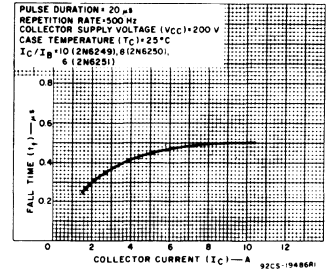


Fig. 13 - Typical fall-time characteristic for all types.

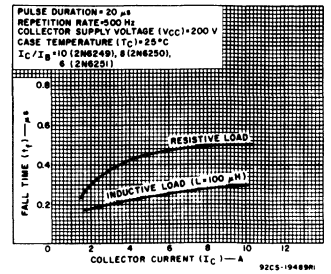


Fig. 14 - Typical inductive- and resistive-load fall-time characteristics for all types.

2N6282, 2N6283, 2N6284, 2N6285, 2N6286, 2N6287

20-Ampere Complementary N-P-N and P-N-P Monolithic Darlington Power Transistors

60-80-100 Volts, 160 Watts

Gain of 2400 (Typ.) at 10 A (2N6282, 2N6283, 2N6284)

Gain of 3500 (Typ.) at 10 A (2N6285, 2N6286, 2N6287)

The RCA-2N6282, 2N6283, and 2N6284 and the 2N6285, 2N6286, and 2N6287 are complementary n-p-n and p-n-p monolithic silicon Darlington transistors designed for general-purpose amplifier and low-speed switching applications. The high gain of these devices makes it possible for them to be driven directly from integrated circuits. These devices are supplied in the JEDEC TO-3 hermetic steel package.

Features:

- Operates from IC without predriver
- High reverse second-breakdown capability
- Monolithic construction
- High voltage ratings:
 - $V_{CEO(sus)} = 60 \text{ V Min.} - 2N6282, 2N6285^{\bullet}$
 - $= 80 \text{ V Min.} - 2N6283, 2N6286^{\bullet}$
 - $= 100 \text{ V Min.} - 2N6284, 2N6287^{\bullet}$

Applications:

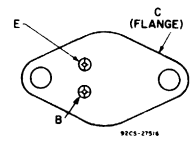
- Power switching
- Hammer drivers
- Series and shunt regulators
- Audio amplifiers

MAXIMUM RATINGS, Absolute-Maximum Values:

	2N6282 2N6285 [•]	2N6283 2N6286 [•]	2N6284 2N6287 [•]	
* V_{CBO}	60	80	100	V
* $V_{CEO(sus)}$	60	80	100	V
* V_{EBO}	5	5	5	V
* I_C	20	20	20	A
* I_{CM}	40	40	40	A
* I_B	0.5	0.5	0.5	A
* P_T				
$T_C \leq 25^{\circ}\text{C}$	160	160	160	W
$T_C > 25^{\circ}\text{C}$	Derate linearly			0.915 W/ $^{\circ}\text{C}$
* T_{stg}, T_J	-65 to 200			$^{\circ}\text{C}$
* T_L	235			$^{\circ}\text{C}$
At distances $\geq 1/16$ in. (1.58 mm) from case for 10 s max.				

* In accordance with JEDEC registration data.
 • For p-n-p devices, voltage and current values are negative.

TERMINAL DESIGNATIONS



JEDEC TO-3

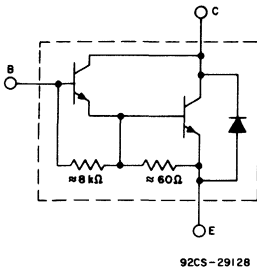


Fig. 1 - Schematic diagram for 2N6282, 2N6283, and 2N6284.

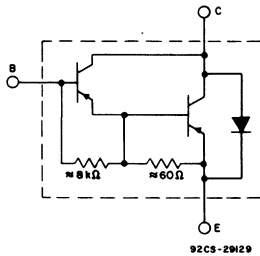


Fig. 2 - Schematic diagram for 2N6285, 2N6286, and 2N6287.

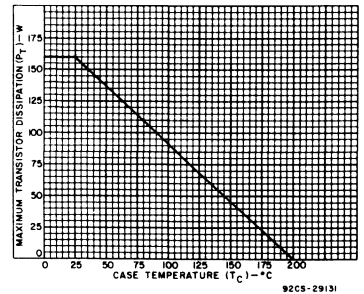


Fig. 3 - Power derating curve for all types.

2N6282, 2N6283, 2N6284, 2N6285, 2N6286, 2N6287

ELECTRICAL CHARACTERISTICS, at Case Temperature (T_C) = 25°C Unless Otherwise Specified

CHARACTERISTIC	TEST CONDITIONS				LIMITS					UNITS	
	VOLTAGE V dc		CURRENT A dc		2N6282 2N6285*		2N6283 2N6286*		2N6284 2N6287*		
	V_{CE}	V_{BE}	I_C	I_B	MIN.	MAX.	MIN.	MAX.	MIN.		MAX.
* I_{CEO}	30 40 50			0 0 0	- - -	1 - -	- - -	- 1 -	- - 1	mA	
* I_{CEX}	60 80 100	-1.5 -1.5 -1.5			- - -	0.5 - -	- - -	- 0.5 -	- - 0.5		
$T_C = 150^\circ\text{C}$	60 80 100	-1.5 -1.5 -1.5			- - -	5 - -	- - -	- 5 -	- - 5		
* I_{EBO}		-5	0		-	2	-	2	-	2	mA
* $V_{CEO(sus)}$			0.1 ^a	0	60	-	80	-	100	-	V
* h_{FE}	3 3		20 ^a 10 ^a		100 750	- 18,000	100 750	- 18,000	100 750	- 18,000	
* $V_{CE(sat)}$			20 ^a 10 ^a	0.2 0.04	- -	3 2	- -	3 2	- -	3 2	V
* V_{BE}	3		10 ^a		-	2.8	-	2.8	-	2.8	V
* $V_{BE(sat)}$			20 ^a	0.2	-	4	-	4	-	4	V
* h_{fe} f = 1 kHz	3		10		300	-	300	-	300	-	
* $ h_{fe} $ f = 1 MHz	3		10		4	-	4	-	4	-	
* C_{ob} $V_{CB} = 10\text{V}, I_E = 0,$ f = 0.1 MHz 2N6282-84 2N6285-87					- -	400 600	- -	400 600	- -	400 600	pF
I_S/b t = 1 s, nonrep.	30				5.3	-	5.3	-	5.3	-	A
$R_{\theta JC}$						1.09	-	1.09	-	1.09	°C/W

- ^a Pulsed: Pulse duration = 300 μs , duty factor = 1.8%.
- * In accordance with JEDEC registration data.
- For p-n-p devices, voltage and current values are negative.

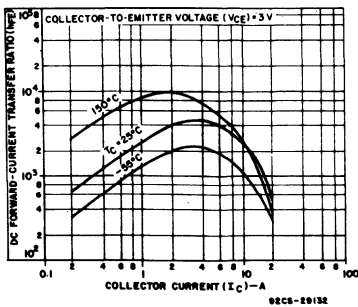


Fig. 4 – Typical dc beta characteristics for 2N6282, 2N6283, and 2N6284.

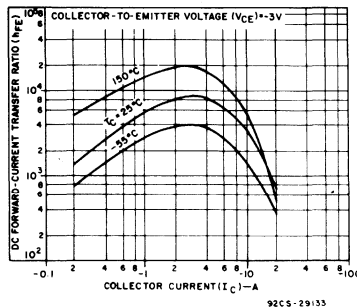


Fig. 5 – Typical dc beta characteristics for 2N6285, 2N6286, and 2N6287.

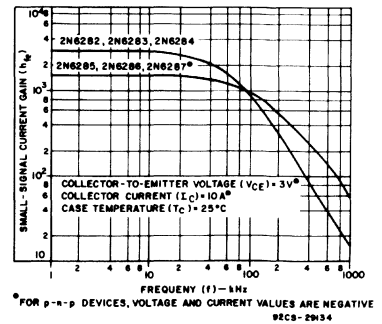
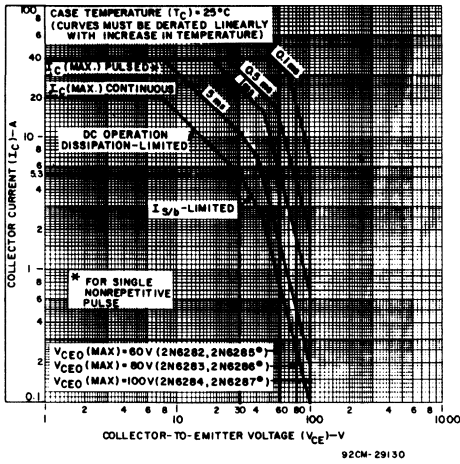


Fig. 6 – Typical small-signal current gain for all types.

2N6282, 2N6283, 2N6284, 2N6285, 2N6286, 2N6287



* FOR p-n-p DEVICES, VOLTAGE AND CURRENT VALUES ARE NEGATIVE

Fig. 7 - Maximum operating areas for all types.

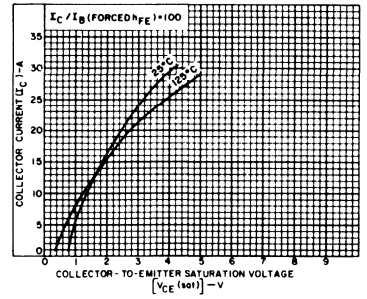


Fig. 8 - Typical saturation characteristics for all types.

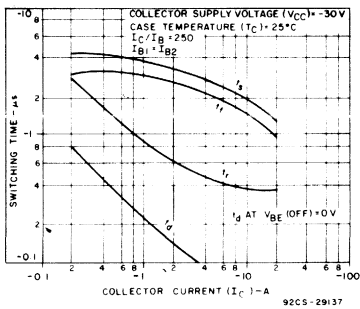


Fig. 10 - Typical switching times for 2N6285, 2N6286, and 2N6287.

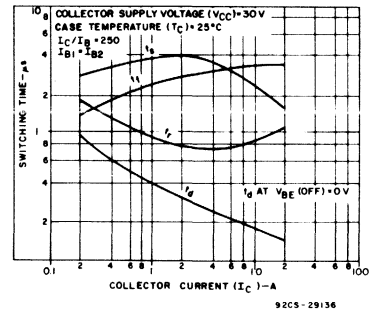


Fig. 9 - Typical switching times for 2N6282, 2N6283, and 2N6284.

2N6300, 2N6301

8-Ampere Silicon N-P-N Monolithic Darlingtons Power Transistors

60- and 80-Volt, 75-Watt Types With Gain of 750 at 4 Amperes

The RCA-2N6300 and 2N6301 are monolithic n-p-n silicon Darlington transistors designed for low- and medium-frequency power applications. The double epitaxial construction of these devices provides good forward and reverse second-breakdown capability. Their high gain makes it possible for them to be driven directly from integrated circuits.

These transistors are supplied in JEDEC TO-213MA/TO-66 hermetic packages.

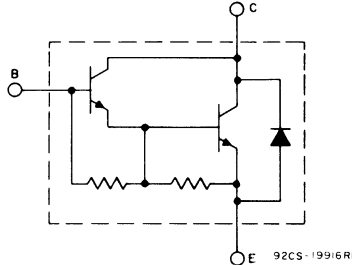


Fig. 1 - Schematic diagram of 2N6300 and 2N6301 Darlington power transistors.

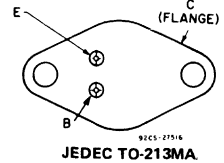
Features:

- Operation from IC without predriver
- Low leakage at high temperature
- High reverse-second-breakdown capability

Applications:

- Power switching
- Audio amplifiers
- Hammer drivers
- Series and shunt regulators

TERMINAL DESIGNATIONS



MAXIMUM RATINGS, Absolute-Maximum Values:

	2N6300	2N6301	
* V_{CBO}	60	80	V
* V_{CEO}	60	80	V
* V_{EBO}	5	5	V
* I_C	8	8	A
* I_{CM}	16	16	A
* I_B	120	120	mA
* P_T			
$T_C \leq 25^\circ C$	75	75	W
$T_C > 25^\circ C$	See Figs. 2 and 3		$^\circ C$
* T_{stg}, T_J	-65 to +200		$^\circ C$
* T_L	At distances $\geq 1/16$ in. (1.58 mm) from set seating plane for 10 s max.		$^\circ C$

* In accordance with JEDEC registration format JS-6 RDF-2.

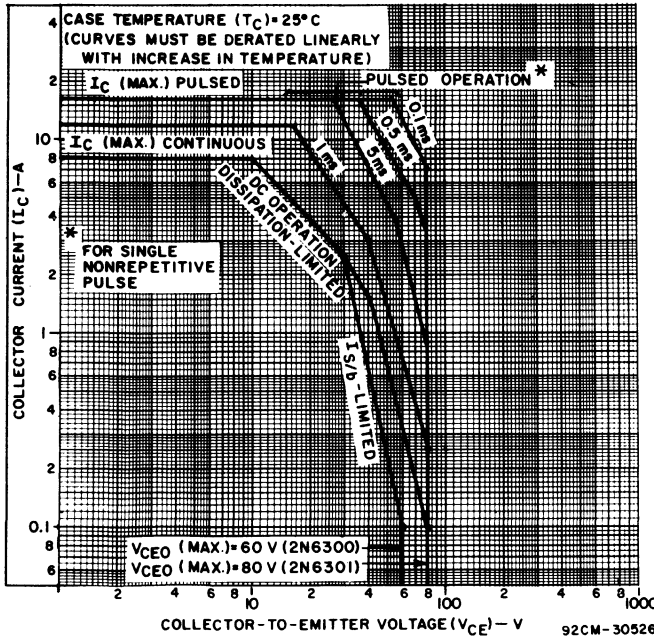


Fig. 2 - Maximum operating areas for types 2N6300 and 2N6301.

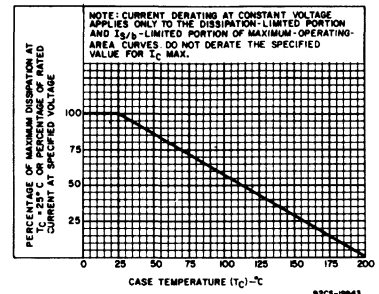


Fig. 3 - Derating curve for both types.

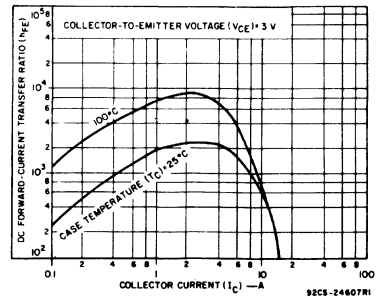


Fig. 4 - Typical dc beta characteristics for both types.

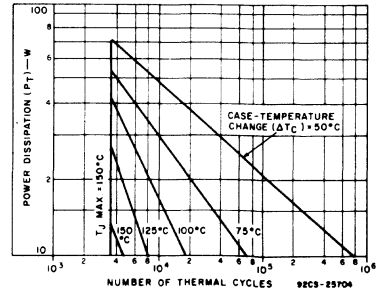


Fig. 5 - Thermal-cycling rating chart for both types.

2N6300, 2N6301

ELECTRICAL CHARACTERISTICS, At Case Temperature (T_C) = 25°C Unless Otherwise Specified

CHARACTERISTIC SYMBOL	TEST CONDITIONS						LIMITS				UNITS	
	DC VOLTAGE V			DC CURRENT A			2N6300		2N6301			
	VCE	VEB	VBE	IC	IE	IB	MIN.	MAX.	MIN.	MAX.		
* I_{CEO}	30 40					0 0	—	0.5	—	—	0.5	mA
* I_{CEX}	60 80		-1.5 -1.5				—	0.5	—	—	0.5	
* I_{CEX} $T_C = 150^\circ\text{C}$	60 80		-1.5 -1.5				—	5	—	—	5	
* I_{EBO}		5		0			—	2	—	2		mA
* h_{FE}	3 3			8 ^a 4 ^a			100 750	— 18,000	100 750	— 18,000		
* $V_{CEO}(sus)$				0.1 ^a			60 ^a	—	80 ^a	—		V
* $V_{CE}(sat)$				4 ^a 8 ^a	0.016 0.08		—	2 3	—	2 3		V
* V_{BE}	3			4 ^a			—	2.8	—	2.8		V
* $V_{BE}(sat)$				8 ^a	0.08		—	4	—	4		V
* $ h_{fe} $ f = 1 MHz	3			3			4	—	4	—		
* C_{obo} f = 0.1 MHz, $V_{CB} = 10\text{ V}$					0		—	200	—	200		pF
* h_{fe} f = 1 kHz	3			3			300	—	300	—		
* $I_{S/b}$ t = 1 s, non rep.	30						2.5	—	2.5	—		A
* $R_{\theta JC}$							—	2.33	—	2.33		°C/W

* In accordance with JEDEC registration data format JS-6 RDF-2.

a Pulsed: Pulse duration = 300 μs , duty factor = 2%.

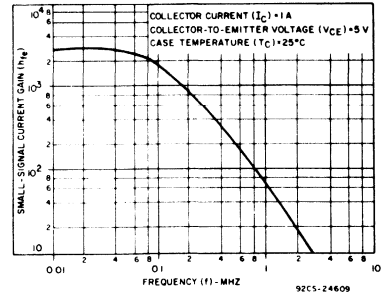


Fig. 6 — Typical small-signal gain for both types.

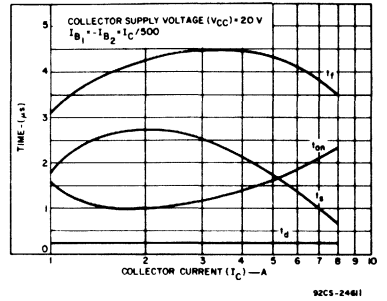


Fig. 7 — Typical saturated switching-time characteristics for both types.

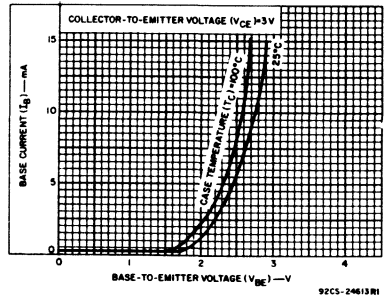


Fig. 8 — Typical input characteristics for both types.

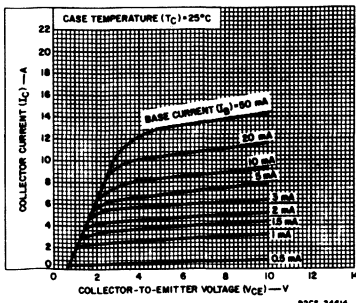


Fig. 9 — Typical output characteristics for both types.

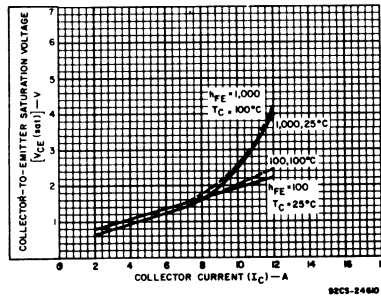


Fig. 10 — Typical saturation-voltage characteristics for both types.

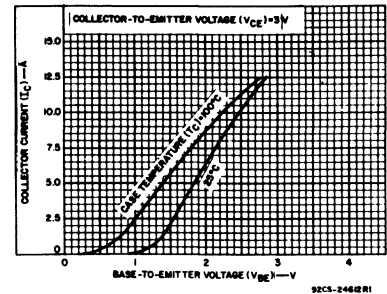


Fig. 11 — Typical transfer characteristics for both types.

2N6306-2N6308, RCS579

High-Voltage, High-Current Silicon N-P-N Power-Switching Transistors

For Off-Line Power Supplies and Other High-Voltage Switching Applications

The RCA-2N6306, 2N6307, 2N6308, and RCS579 are epitaxial silicon n-p-n power transistors with pi-nu construction. They are hermetically sealed in a steel JEDEC TO-3 package, and differ mainly in voltage ratings, saturation voltage, and beta characteristics. The exceptional second-breakdown and high voltage ratings, to-

gether with the high gain, low saturation voltage and fast-switching capability of this series of devices, make them particularly suitable for inverter circuits operating directly off the rectified 120-volt power line or in a bridge configuration operating from the rectified 240-volt line.

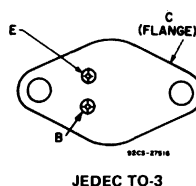
Features:

- Fast Switching Speed
- High Voltage Ratings:
V_{CE}R = 350 V to 450 V
- High Gain at I_C = 3 A
- Thermal-Cycling Rating Chart

Applications:

- Off-Line Power Supplies
- High-Voltage Inverters
- Switching Regulators
- Motor Controls

TERMINAL DESIGNATIONS



MAXIMUM RATINGS, Absolute-Maximum Values:

	RCS579	2N6306	2N6307	2N6308	
V _{CBO}	500	500	600	700	V
V _{CE} R(sus) R _{BE} = 50 Ω	400	350	400	450	V
V _{CE} O(sus)	250	250	300	350	V
V _{EBO}	6	8	8	8	V
I _C	8	8	8	8	A
I _{CM}	16	16	16	16	A
I _B	4	4	4	4	A
P _T T _C up to 25°C	125	125	125	125	W
T _C above 25°C	Derate linearly to 200°C				
T _{stg} , T _J	-65 to +200				°C
T _L At distance ≥ 1/16 in. (1.58 mm) from seating plane for 10 s max.	235				°C

*2N-Series types in accordance with JEDEC registration data format (JS-6 RDF-1)

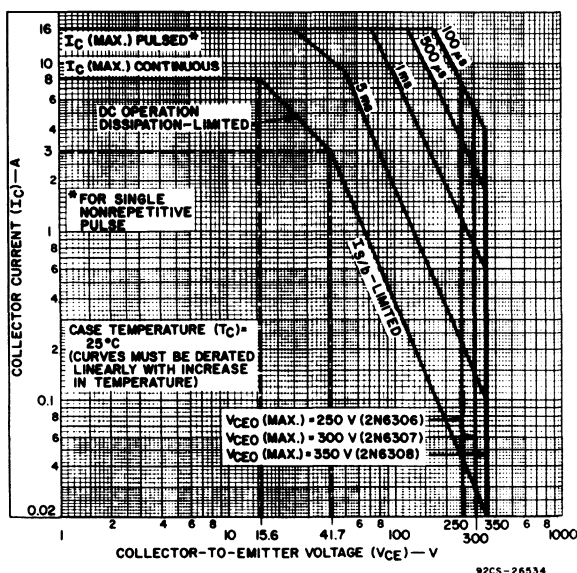


Fig. 1 - Maximum operating areas for 2N6306-2N6308.

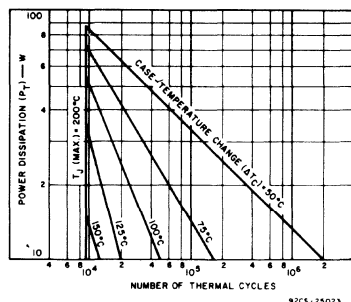


Fig. 2 - Thermal-cycling rating chart for all types.

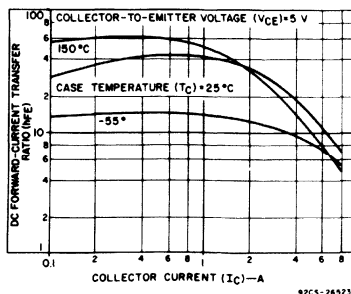


Fig. 3 - Typical dc beta characteristics for all types.

2N6306-2N6308, RCS579

ELECTRICAL CHARACTERISTICS, $T_C = 25^\circ\text{C}$ Unless Otherwise Specified.

CHARACTERISTIC	TEST CONDITIONS				LIMITS								UNITS
	VOLTAGE V dc		CURRENT A dc		2N6306		2N6307		2N6308		RCS579		
	V _{CE}	V _{BE}	I _C	I _B	MIN.	MAX.	MIN.	MAX.	MIN.	MAX.	MIN.	MAX.	
* I _{CEO}	250			0	-	0.5	-	-	-	-	-	0.5	
	300			0	-	-	-	0.5	-	-	-	-	
	350			0	-	-	-	-	-	0.5	-	-	
* I _{CEV}	500	-1.5			-	0.5	-	-	-	-	-	0.5	
	600	-1.5			-	-	-	0.5	-	-	-	-	
	700	-1.5			-	-	-	-	-	0.5	-	-	
* T _C = 150°C	450	-1.5			-	2.5	-	-	-	-	-	2.5	
	550	-1.5			-	-	-	2.5	-	-	-	-	
	650	-1.5			-	-	-	-	-	2.5	-	-	
* I _{EBO}		-6 -8	0 0		- -	- 1	- -	- 1	- -	- 1	- -	2 -	
* V _{CEO(sus)}			0.1 ^a	0	250	-	300	-	350	-	250	-	V
* V _{CER(sus)} R _{BR} = 50 Ω			0.1 ^b		350	-	400	-	450	-	400	-	V
* V _{EBO} I _E = 1 mA			0		-	-	-	-	-	-	6	-	V
* h _{FE}	5		3 ^a		15	75	15	75	12	60	12	-	
	5		8 ^a		4	-	4	-	3	-	3	-	
* V _{BE}	5		3 ^a		-	1.3	-	1.3	-	1.5	-	1.5	V
* V _{BE(sat)}			8 ^a	2	-	2.3	-	2.3	-	-	-	-	V
			8 ^a	2.67	-	-	-	-	-	2.5	-	2.5	V
* V _{CE(sat)}			3 ^a	0.6	-	0.8	-	1	-	1.5	-	1.5	V
			8 ^a	2	-	5	-	5	-	-	-	-	V
			8 ^a	2.67	-	-	-	-	-	5	-	5	V
* h _{fe} f = 1 MHz	10		0.3		5	-	5	-	5	-	5	-	
* E _{S/b} L = 40 mH R _{BB} = 3kΩ		-1.5	3		180	-	180	-	180	-	180	-	mJ
* I _{S/b} t _p = 1 s, nonrep.	40				3.15	-	3.15	-	3.15	-	3.15	-	A
* C _{obo} V _{CB} = 10 V, f = 0.1 MHz					-	250	-	250	-	250	-	250	pF
* t _r V _{CC} = 125 V			3	0.6	-	0.6	-	0.6	-	0.6	-	0.6	
* t _s V _{CC} = 125 V t _p = 25 μs			3	+0.6 -1.5	-	1.6	-	1.6	-	1.6	-	2	μs
			3	+0.6 -1.5	-	0.8	-	0.8	-	0.8	-	-	
* t _f V _{CC} = 125 V			3	+0.6 -1.5	-	0.4	-	0.4	-	0.4	-	0.4	
* R _{θJC}					-	1.4	-	1.4	-	1.4	-	1.4	°C/W

* 2N-Series types in accordance with JEDEC registration data format (JS-6, RDF-1).

^a Pulsed; pulse duration = 300 μs, duty factor ≤ 2%.^b CAUTION: The sustaining voltage V_{CEO(sus)} and V_{CER(sus)} MUST NOT be measured on a curve tracer. V_{CEO(sus)} should be measured by the pulse method (Note "a").

2N6306-2N6308, RCS579

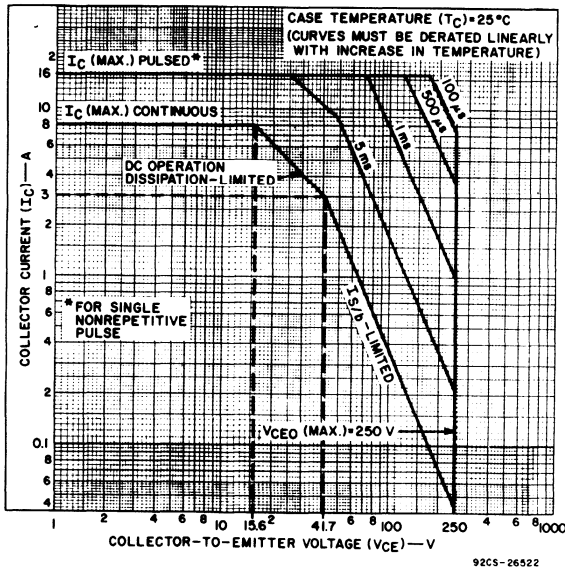


Fig. 4 - Maximum operating areas for RCS579.

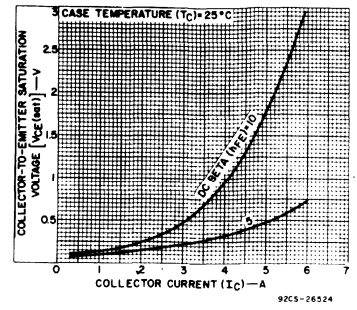


Fig. 5 - Typical collector-to-emitter saturation-voltage characteristics for all types.

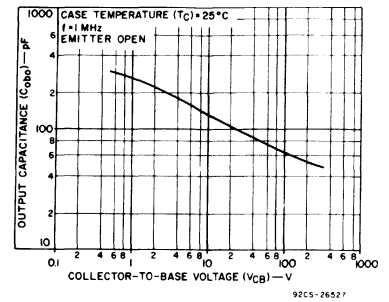


Fig. 6 - Typical output capacitance for all types.

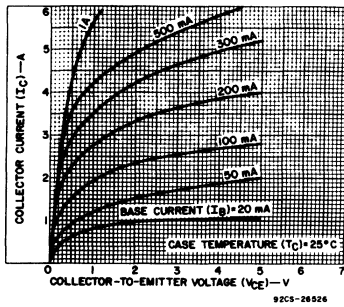


Fig. 7 - Typical output characteristics for all types.

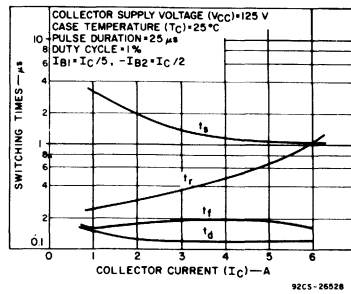


Fig. 8 - Typical saturated-switching-time characteristics for all types.

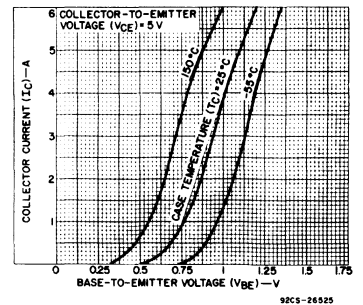


Fig. 9 - Typical transfer characteristics for all types.

2N6326, 2N6327

High-Current, High-Power, High-Speed N-P-N Power Transistors

The RCA-2N6326 and 2N6327 are epitaxial-base silicon n-p-n transistors intended for a wide variety of high-power, high-current applications, such as power-switching circuits, driver and output stages for series and shunt

regulators, dc-to-dc converters, inverters, and solenoid (hammer)/relay drivers.

These devices differ in maximum voltage ratings. They are supplied in JEDEC TO-204MA hermetic steel packages.

Features:

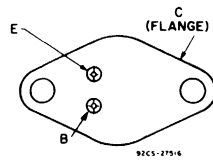
- Specification for h_{FE} and $V_{CE(sat)}$ up to 30 A
- Current gain bandwidth product $f_T = 3 \text{ MHz (min.) at } 1 \text{ A}$
- Low saturation voltage with high beta
- High dissipation capability
- 200 mJ $E_{S/b}$ characteristic

MAXIMUM RATINGS, Absolute-Maximum Values:

	2N6326	2N6327	
* V_{CBO}	60	80	V
* $V_{CEO(sus)}$	60	80	V
* V_{EBO}	5	5	V
* I_C	30	30	A
* I_{CM}	40	40	A
* I_B	10	10	A
* I_{BM}	15	15	A
* P_T			W
At $T_C \leq 25^\circ\text{C}$	200	200	
At $T_C > 25^\circ\text{C}$	Derate linearly	1.15	W/°C
See Figs. 1 and 2			
* T_{stg}, T_J	-65 to 200	-65 to 200	°C
T_L			°C
At distance $\geq 1/32$ in. (0.8 mm) from seating plane for 10 s max.	230	230	°C

* In accordance with JEDEC registration data format JS-6 RDF-2.

TERMINAL DESIGNATIONS



JEDEC TO-204MA

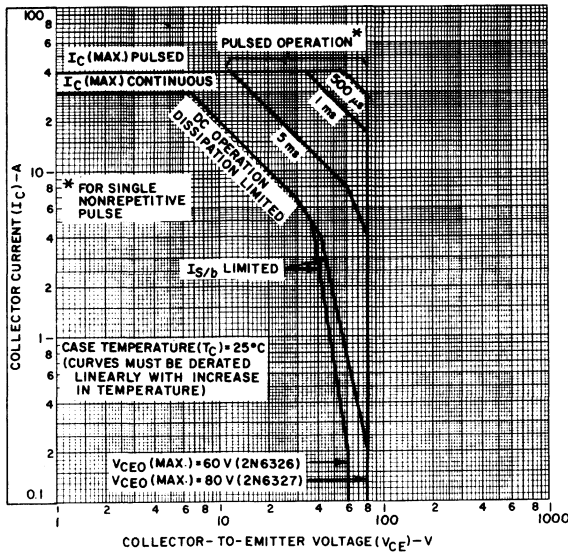


Fig. 1 - Maximum operating areas for 2N6326 and 2N6327.

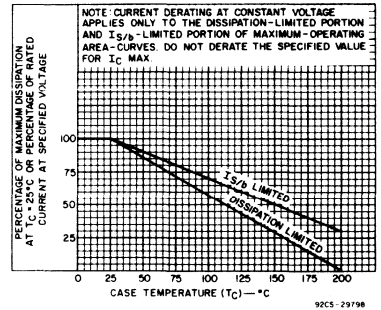


Fig. 2 - Derating curves for 2N6326 and 2N6327.

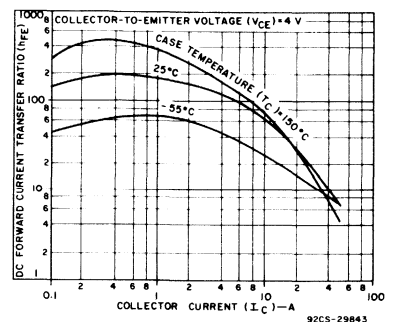


Fig. 3 - Typical dc beta characteristics as a function of collector current for 2N6326 and 2N6327.

2N6326, 2N6327

ELECTRICAL CHARACTERISTICS, At Case Temperature (T_C) = 25°C
 Unless Otherwise Specified

CHARACTERISTIC	TEST CONDITIONS				LIMITS				UNITS
	V dc		CURRENT A dc		2N6326		2N6327		
	V _{CE}	V _{BE}	I _C	I _B	Min.	Max.	Min.	Max.	
* I _{CES}	60				—	0.5	—	—	mA
	80				—	—	—	0.5	
* I _{CES} T _C = 150°C	30				—	5	—	—	
	40				—	—	—	5	
* I _{CEO}	30				—	1	—	—	mA
	40				—	—	—	1	
* I _{EBO}		-5			—	0.5	—	0.5	V
* h _{FE}	4		5 ^a		25	—	25	—	
	4		15 ^a		12	—	12	—	
	4		30 ^a		6	30	6	30	
* V _{CEO(sus)}			0.03		60	—	80	—	
* V _{BE}	4		15 ^a		—	2	—	2	
	4		30 ^a		—	4	—	4	
* V _{CE(sat)}			15 ^a	2	—	1.5	—	1.5	
			30 ^a	7.5	—	3	—	3	
I _S /b t _p = 1 s nonrep.	20				10	—	10	—	
ES/b L = 125 μH, R _{BE} = 51 Ω		-1.5	10		6.25	—	6.25	—	mJ
L = 20 mH, R _{BE} = 100 Ω		0	4.47		200	—	200	—	
* h _{fe} f = 1 MHz	10		1		3	—	3	—	μs
* h _{fe} f = 1 kHz	10		1		30	—	30	—	
t _{on}	V _{CC} =		15	2	0.45 (Typ.)	—	0.45 (Typ.)	—	μs
t _{off}	30		15	2 ^b	0.9 (Typ.)	—	0.9 (Typ.)	—	
R _{θJC}	20		5		—	0.875	—	0.875	°C/W

*In accordance with JEDEC registration data format JS-6 RDF-2.

^aPulsed; pulse duration = 300 μs, duty factor = 1.8%.

^bI_{B1} = -I_{B2}.

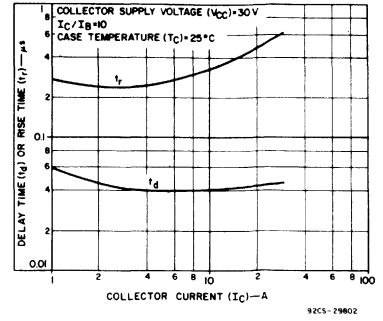


Fig. 4 — Typical delay-time and rise-time characteristics as a function of collector current for 2N6326 and 2N6327.

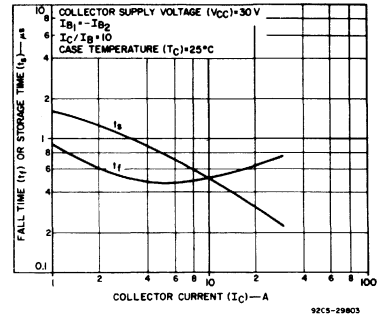


Fig. 5 — Typical storage-time and fall-time characteristics as a function of collector current for 2N6326 and 2N6327.

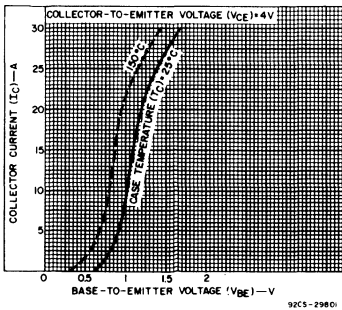


Fig. 6 — Typical transfer characteristics for 2N6326 and 2N6327.

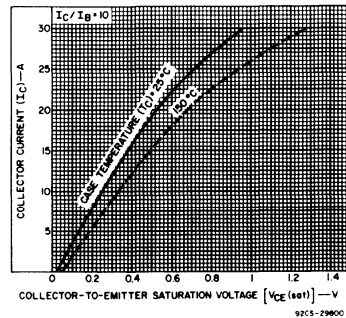


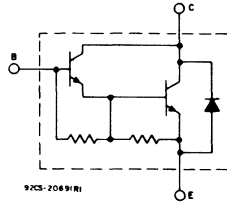
Fig. 7 — Typical saturation voltage characteristics for 2N6326 and 2N6327.

2N6383-2N6385, 2N6055, 2N6056, RCA1000, RCA1001

8- and 10-Ampere N-P-N Darlington Power Transistors

For Use as Output Devices in Switching and Amplifier Applications
40-60-80 Volts, 90-100 Watts

The RCA devices are monolithic n-p-n silicon Darlington transistors designed for low- and medium-frequency power applications. The double epitaxial construction of these devices provides good forward and reverse second-breakdown capability; their high gain makes it possible for them to be driven directly from integrated circuits.



Schematic diagram for all types.

Features:

- Operation from IC without predriver
- Low leakage at high temperature
- High reverse-second-breakdown capability

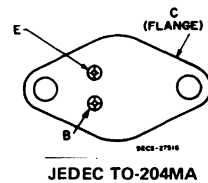
Applications:

- Power switching
- Audio amplifiers
- Series and shunt regulators
- Hammer drivers

MAXIMUM RATINGS, Absolute-Maximum Values:

	2N6385	2N6384	2N6383	2N6055	2N6056	RCA1000	RCA1001		
*V _{CB0}	80	60	40	60	80	60	80	V	
V _{CEr(sus)} R _{BE} = 100 Ω	80	60	40	60	80	—	—	V	
*V _{CEO(sus)}	80	60	40	60	80	60	80	V	
V _{CEV(sus)} V _{BE} = -1.5 V	—	—	—	60	80	—	—	V	
*V _{CEX} V _{BE} = -1.5 V, R _{BB} = 100 Ω	80	60	40	—	—	—	—	V	
*V _{EBO}	5	5	5	5	5	5	5	V	
*I _C	10	10	10	8	8	8	8	A	
I _{CM}	15	15	15	16	16	15	15	A	
*I _B	0.25	0.25	0.25	0.12	0.12	0.1	0.1	mA	
*P _T T _C < 25°C	100	100	100	100	100	90	90	W	
T _C > 25°C	Derate linearly to 200°C								
*T _{stg} , T _J	-65 to +200								°C
*T _L At distance ≥ 1/32 in. (0.8 mm) from seating plane for 10 s max.	235								°C

TERMINAL DESIGNATIONS



*2N-Series types in accordance with JEDEC registration data format JS-6 RDF-2.

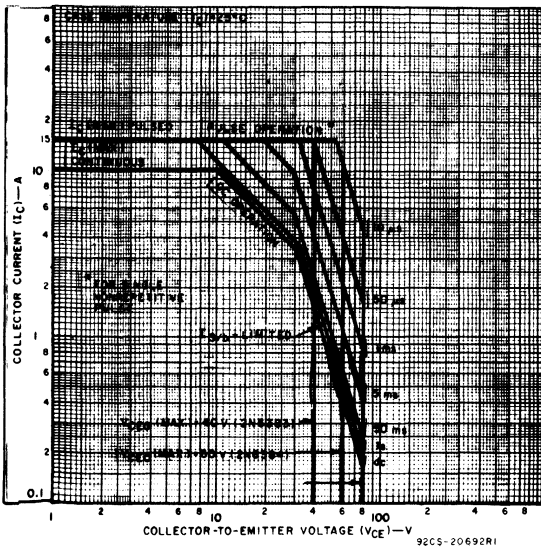


Fig. 1 — Maximum operating area for 2N6383-2N6385.

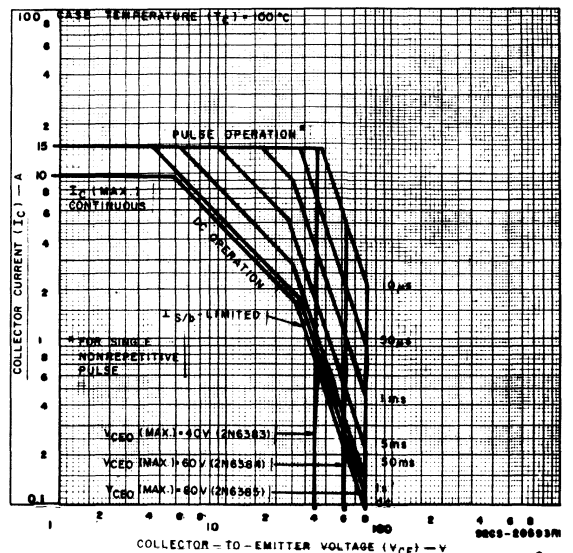


Fig. 2 — Maximum operating area for 2N6383-2N6385 at T_C = 100°C.

2N6383-2N6385, 2N6055, 2N6056, RCA1000, RCA1001

ELECTRICAL CHARACTERISTICS, At Case Temperature, $T_C = 25^\circ\text{C}$ Unless Otherwise Specified

CHARACTERISTIC	TEST CONDITIONS					LIMITS						UNITS
	VOLTAGE V dc			CURRENT A dc		2N6385		2N6384		2N6383		
	V_{CE}	V_{EB}	V_{BE}	I_C	I_B	MIN.	MAX.	MIN.	MAX.	MIN.	MAX.	
I_{CEO}	80			0	0	-	1	-	-	-	-	mA
	60			0	0	-	-	-	1	-	-	
	40			0	0	-	-	-	-	-	1	
I_{CEV}	80		-1.5			-	0.3	-	-	-	-	mA
	60		-1.5			-	-	-	0.3	-	-	
	40		-1.5			-	-	-	-	-	0.3	
$T_C = 150^\circ\text{C}$	80		-1.5			-	3	-	-	-	-	mA
	60		-1.5			-	-	-	3	-	-	
	40		-1.5			-	-	-	-	-	3	
I_{EBO}		5		0		-	5	-	5	-	5	mA
$V_{CEO(sus)}$				0.2 ^a	0	80	-	60	-	40	-	V
$V_{CE(sus)}$ $R_{BE} = 100 \Omega$				0.2 ^a		80	-	60	-	40	-	V
$V_{CEV(sus)}$			-1.5	0.2 ^a		80	-	60	-	40	-	V
h_{FE}	3			5 ^a		1000	20,000	1000	20,000	1000	20,000	
	3			10 ^a		100	100	100	100	100	100	
V_{BE}	3			5 ^a		-	2.8	-	2.8	-	2.8	V
	3			10 ^a		-	4.5	-	4.5	-	4.5	V
$V_{CE(sat)}$				5 ^a	0.01 ^a	-	2	-	2	-	2	V
				10 ^a	0.1 ^a	-	3	-	3	-	3	V
V_F				-10		-	4	-	4	-	4	V
h_{fe} $f = 1 \text{ kHz}$	5			1		1000	-	1000	-	1000	-	
	5			1		20	-	20	-	20	-	
C_{obo} $f = 1 \text{ MHz}$	$V_{CB} = 10$				$I_E = 0$	-	200	-	200	-	200	pF
							-	0.55	-	-	-	A
I_S/b $t = 1 \text{ s}$ non rep.	75					0.22	-	-	-	-	-	A
	55					3.33	-	3.33	-	3.33	-	A
$R_{\theta JC}$						-	1.75	-	1.75	-	1.75	$^\circ\text{C/W}$

^a Pulsed: Pulse duration = 300 μs , duty factor = 1.8%.

* 2N-Series types in accordance with JEDEC registration data format JS-6 RDF-2.

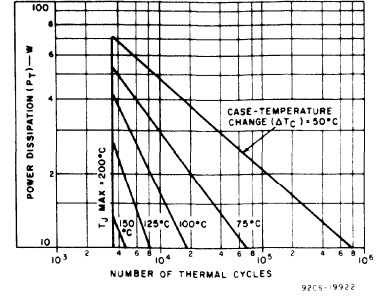


Fig. 3 - Thermal-cycling rating chart for 2N6055-2N6056, 2N6383-2N6385.

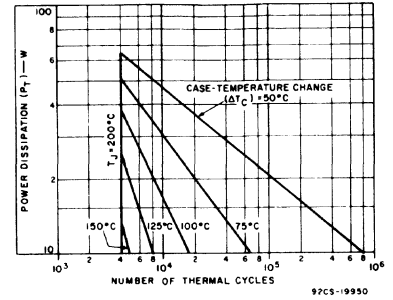


Fig. 4 - Thermal-cycling rating chart for RCA1000, RCA1001.

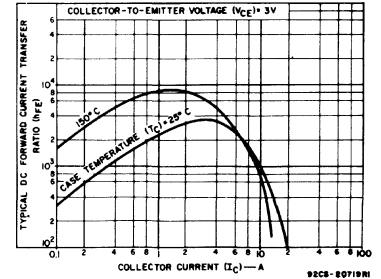


Fig. 5 - Typical dc beta characteristics for all types.

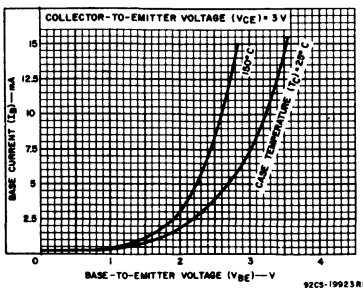


Fig. 6 - Typical input characteristics for 2N6383-2N6385, 2N6055, 2N6056.

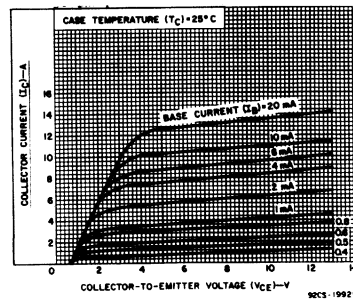


Fig. 7 - Typical output characteristics for 2N6383-2N6385, 2N6055, 2N6056.

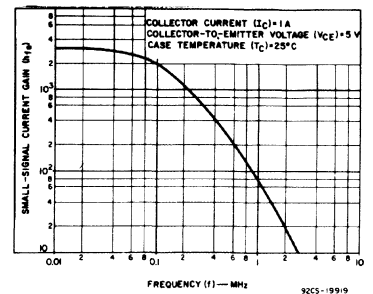


Fig. 8 - Typical small-signal gain for all types.

2N6383-2N6385, 2N6055, 2N6056, RCA1000, RCA1001

ELECTRICAL CHARACTERISTICS, At Case Temperature, $T_C = 25^\circ\text{C}$ Unless Otherwise Specified

CHARACTERISTIC	TEST CONDITIONS						LIMITS								UNITS	
	DC VOLTAGE V			DC CURRENT A			2N6055		2N6056		RCA1000		RCA1001			
	V_{CE}	V_{EB}	V_{BE}	I_C	I_E	I_B	MIN.	MAX.	MIN.	MAX.	MIN.	MAX.	MIN.	MAX.		
I_{CEO}	30 40				0 0		-	0.5	-	-	0.5	-	-	0.5	mA	
I_{CER} $R_{BE} = 1\text{ k}\Omega$	60 80						-	-	-	-	1	-	-	1		
I_{CER} $R_{BE} = 1\text{ k}\Omega$ $T_C = 150^\circ\text{C}$	60 80						-	-	-	-	5	-	-	5	mA	
I_{CEX}	60 80	-1.5 -1.5					-	0.5	-	-	-	-	-	-	mA	
I_{CEX} $T_C = 150^\circ\text{C}$	60 80	-1.5 -1.5					-	5	-	-	5	-	-	-	mA	
E_{BO}		5		0			-	2	-	2	-	2	-	2	mA	
h_{FE}	3 3 3			$8^{\#}$ $4^{\#}$ $3^{\#}$			100 750 18,000	-	100 750 18,000	-	-	750 1000 1000	-	-		
$V_{(BR)CEO}$				$0.1^{\#}$	0		-	-	-	-	-	-	-	80	V	
$V_{CEO(sat)}$				$0.1^{\#}$			$60^{\#}$	-	$80^{\#}$	-	-	-	-	-	V	
$V_{CER(sat)}$ $R_{BE} = 100\ \Omega$				$0.1^{\#}$			$60^{\#}$	-	$80^{\#}$	-	-	-	-	-	V	
$V_{CEX(sus)}$			-1.5	$0.1^{\#}$			$60^{\#}$	-	$80^{\#}$	-	-	-	-	-	V	
$V_{CE(sat)}$				$3^{\#}$ $4^{\#}$ $8^{\#}$ $8^{\#}$			0.012 0.016 0.04 0.08	-	-	2	2	-	2	4	4	V
V_{BE}	3 3			$3^{\#}$ $4^{\#}$			-	-	2.8	2.8	-	2.5	-	2.5	V	
$V_{BE(sat)}$				$8^{\#}$			0.08	-	4	4	-	-	-	-	V	
h_{fe} $f = 1\text{ MHz}$	3			3			4	-	4	-	-	-	-	-		
C_{obo} $f = 0.1\text{ MHz}$ $V_{CB} = 10\text{ V}$					0		-	200	-	200	-	-	-	-	pF	
τ_{fe} $f = 1\text{ kHz}$	3			3			300	-	300	-	-	-	-	-		
S/b $f = 1\text{ s}$ non rep.	33.3 40						3	-	3	-	-	-	-	-	A	
$R_{\theta JC}$							-	1.75	-	1.75	-	1.94	-	1.94	$^\circ\text{C/W}$	

* In accordance with JEDEC registration data format JS-6 RDF-2.
 # Pulsed. Pulse duration = 300 μs , duty factor = 2%

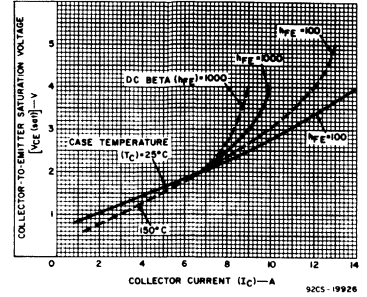


Fig. 9 - Typical saturation characteristics for 2N6055, 2N6056, RCA1000, RCA1001.

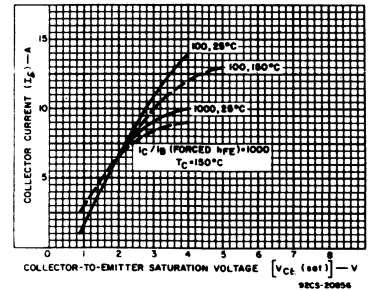


Fig. 10 - Typical saturation characteristics for 2N6383-2N6385.

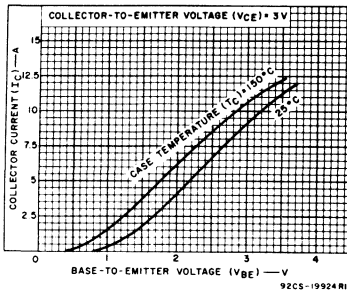


Fig. 11 - Typical transfer characteristics for 2N6383-2N6385, 2N6055, 2N6056.

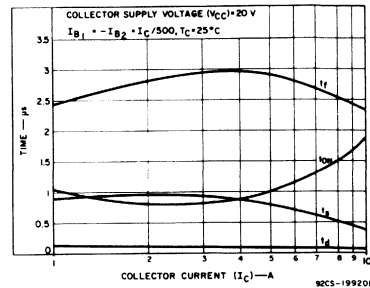


Fig. 12 - Typical saturated switching-time characteristics for 2N6383-2N6385, 2N6055, 2N6056.

2N6383-2N6385, 2N6055, 2N6056, RCA1000, RCA1001

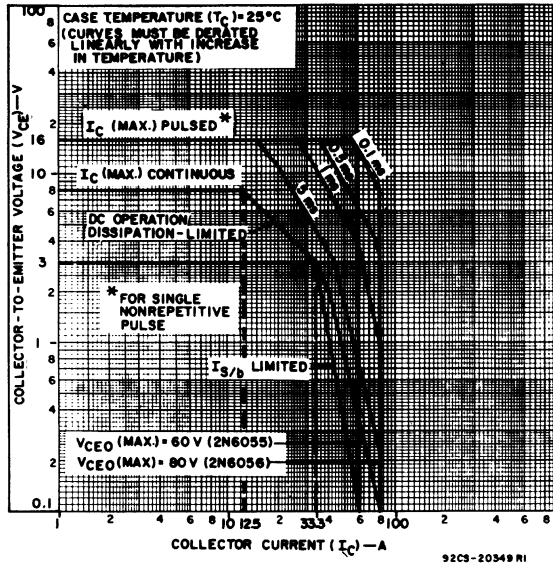


Fig. 13 - Maximum operating areas for 2N6055 and 2N6056.

2N6386, 2N6387, 2N6388

8- and 10-Ampere N-P-N Darlington Power Transistors

60-80-100 Volts, 65 Watts

These RCA devices are monolithic n-p-n silicon Darlington transistors designed for low- and medium-frequency power applications. The double epitaxial construction of these transistors provides good forward and reverse second-breakdown capability; their high gain makes it possible for them to be driven directly from integrated circuits.

These devices are supplied in the JEDEC TO-220AB straight-lead version of the VERSA-WATT package. Optional lead configurations are available upon request. For information, contact your nearest RCA Sales Office.

The 2N6386 is complementary to the RCA8203 and the 2N6666, the 2N6387 is complementary to the RCA8203A and

the 2N6667, and the 2N6388 is complementary to the RCA8203B and the 2N6668.

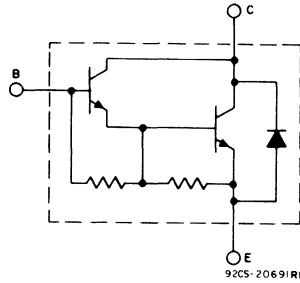


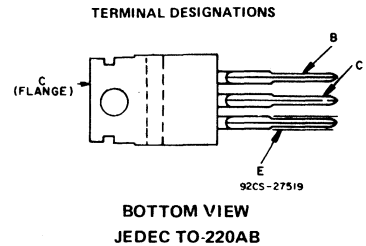
Fig. 1 - Schematic diagram for all types.

Features:

- Operates from IC without predriver
- Low leakage at high temperature
- High reverse second-breakdown capability

Applications:

- Power switching
- Hammer drives
- Series and shunt regulators
- Audio amplifiers



BOTTOM VIEW
JEDEC TO-220AB

MAXIMUM RATINGS, Absolute-Maximum Values:

	2N6386	2N6387	2N6388	
V _{CB0}	40	60	80	V
V _{CEr} (sus)				
R _{BE} = 100 Ω	40	60	80	V
V _{CEO} (sus)	40	60	80	V
V _{CEV} (sus)				
V _{BE} = -1.5 V	40	60	80	V
V _{EB0}	5	5	5	V
I _C	8	10	10	A
I _{CM}	15	15	15	A
I _B	0.25	0.25	0.25	A
P _T				
T _C < 25°C	65	65	65	W
T _C > 25°C	Derate linearly to 150°C			
θ _{stg} , T _J	-65 to +150			°C
θ _L	At distances > 1/8 in. (3.17 mm) from case for 10 s max.			235 °C

1 2N- Series types in accordance with JEDEC registration data format JS-6 RDF-2.

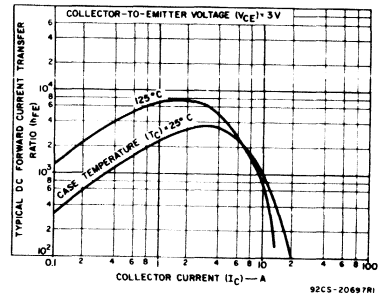


Fig. 2 - Typical dc beta characteristics for 2N6386, 2N6387, and 2N6388.

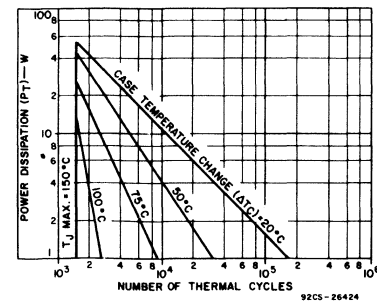


Fig. 3 - Thermal-cycling rating chart for 2N6386, 2N6387, and 2N6388.

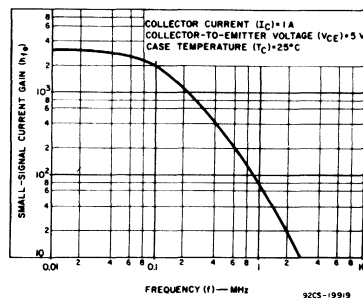


Fig. 4 - Typical small-signal gain for all types.

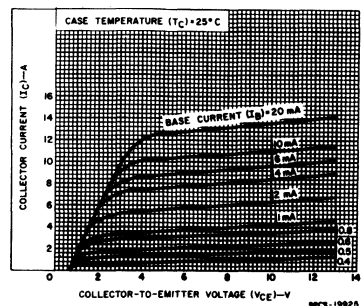


Fig. 5 - Typical output characteristics for 2N6386, 2N6387, and 2N6388.

2N6386, 2N6387, 2N6388

ELECTRICAL CHARACTERISTICS, At Case Temperature (T_C) = 25°C Unless Otherwise Specified

CHARACTERISTIC SYMBOL	TEST CONDITIONS				LIMITS						UNITS
	VOLTAGE V dc		CURRENT A dc		2N6386		2N6387		2N6388		
	V _{CE}	V _{BE}	I _C	I _B	MIN.	MAX.	MIN.	MAX.	MIN.	MAX.	
* I _{CEO}	80 60 40			0 0 0	- - -	- - -	- - -	1 - -	- - -	1 - -	mA
* I _{CEV}	80 60 40	-1.5 -1.5 -1.5			- - -	- - -	- - -	1 0.3 -	- - -	0.3 - -	
$T_C = 125^\circ\text{C}$	80 60 40	-1.5 -1.5 -1.5			- - -	- - -	- - -	3 3 -	- - -	3 - -	
* I _{EBO}		5	0		-	5	-	5	-	5	mA
* V _{CEO(sus)}			0.2 ^a	0	40	-	60	-	80	-	
* V _{CER(sus)} R _{BE} = 100 Ω			0.2 ^a		40	-	60	-	80	-	
* V _{CEV(sus)}		-1.5	0.2 ^a		40	-	60	-	80	-	V
* h _{FE}	3 3 3 3		3 ^a 5 ^a 8 ^a 10 ^a		1000 20,000 - -	-	1000 20,000 - -	1000 20,000 - -	1000 20,000 - -	20,000 20,000 - -	
* V _{BE}	3 3 3 3		3 ^a 5 ^a 8 ^a 10 ^a		- - - -	2.8 - - -	- - - -	2.8 - - -	- - - -	2.8 - - -	
* V _{CE(sat)}			3 ^a 5 ^a 8 ^a 10 ^a	0.006 ^a 0.01 ^a 0.08 ^a 0.1 ^a	- - - -	2 - - -	- - - -	2 - - -	- - - -	2 - - -	V
* V _F			-8 ^a -10 ^a		- - -	4 - -	- - -	- - -	4 - -	- - -	
* h _{fe} f = 1 kHz	5		1		1000	-	1000	-	1000	-	
* h _{fe} f = 1 MHz	5		1		20	-	20	-	20	-	
* C _{ob} V _{CB} = 10 V, f = 1 MHz					-	200	-	200	-	200	pF
* I _{S/b} t = 1 s, nonrep.	25				2.6	-	2.6	-	2.6	-	
R θ JC					-	1.92	-	1.92	-	1.92	°C/W

^a Pulsed: Pulse duration = 300 μs, duty factor = 1.8%.
* In accordance with JEDEC registration data format JS-6 RDF-2.

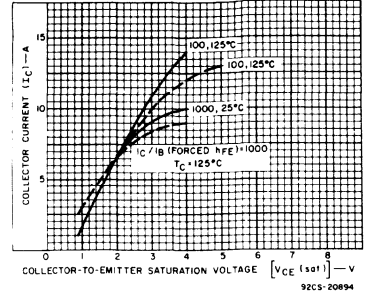


Fig. 6 - Typical saturation characteristics for 2N6386, 2N6387, and 2N6388.

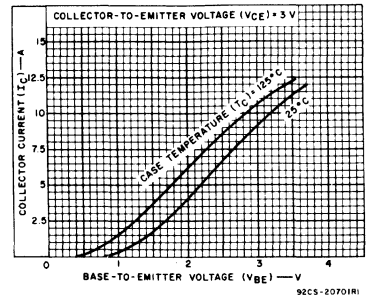


Fig. 7 - Typical transfer characteristics for 2N6386, 2N6387, and 2N6388.

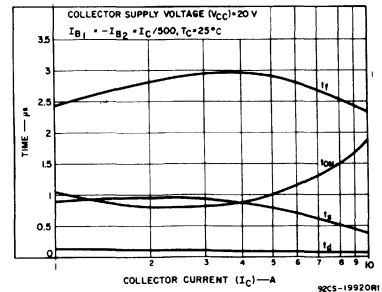


Fig. 8 - Typical saturated switching-time characteristics for 2N6386, 2N6387, and 2N6388.

2N6386, 2N6387, 2N6388

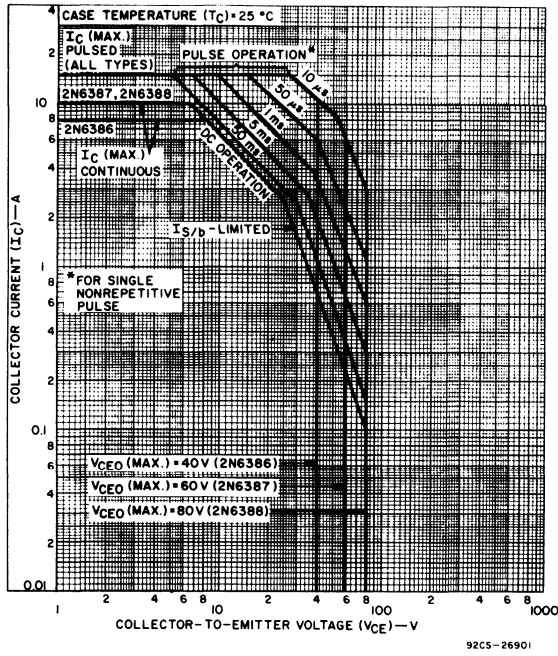


Fig. 9 — Maximum operating areas for 2N6386, 2N6387, and 2N6388 at $T_C = 25^\circ\text{C}$.

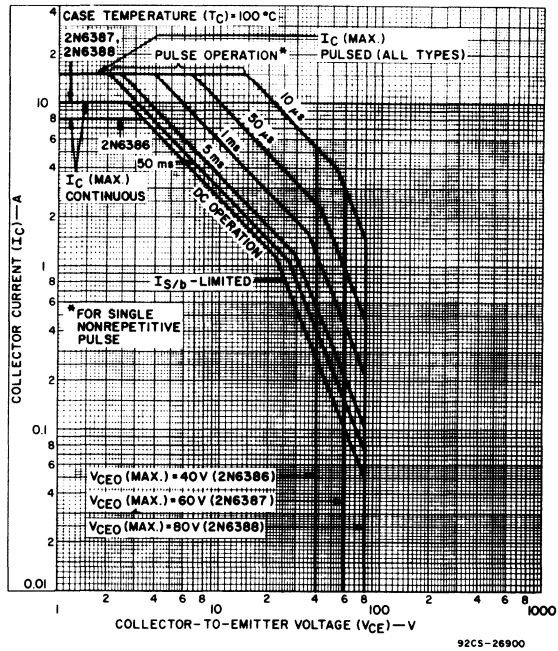


Fig. 10 — Maximum operating areas for 2N6386, 2N6387, and 2N6388 at $T_C = 100^\circ\text{C}$.

2N6420, 2N6421, 2N6422, 2N6423

High-Voltage Medium-Power Silicon P-N-P Transistors

For High-Speed Switching and Linear-Amplifier Applications

The RCA-2N6420, 2N6421, 2N6422, and 2N6423 are epitaxial silicon p-n-p power transistors with high-voltage ratings and fast switching speeds. Typical applications for these transistors include high-voltage

operational amplifiers, switching regulators, converters, inverters, deflection stages and high-fidelity amplifiers.

These types are supplied in steel JEDEC TO-213MA hermetic packages.

Features:

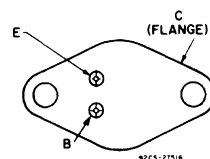
- High voltage ratings:
 - $V_{CEO(sus)} = -175$ V max. (2N6420)
 - $= -250$ V max. (2N6421)
 - $= -300$ V max. (2N6422)
 - $= -300$ V max. (2N6423)
- Large safe-operating area
- Thermal-cycling rating

MAXIMUM RATINGS, Absolute-Maximum Values:

	2N6420	2N6421	2N6422	2N6423	
V_{CBO}	-250	-375	-500	-500	V
$V_{CEO(sus)}$	-175	-250	-300	-300	V
V_{EBO}			-6		V
I_C	-1		-2		A
I_{CM}			-5		A
I_B			-1		A
P_T			20		W
$T_C \leq 100^\circ C, V_{CE} \leq 50$ V			35		W
$T_C \leq 25^\circ C, V_{CE} \leq 40$ V					
$T_C > 25^\circ C, V_{CE} > 40$ V					See Fig. 1
$T_C > 25^\circ C, V_{CE} > 40$ V					See Figs. 1 & 3
$T_{stg}^* T_J$			-65 to +200		$^\circ C$
T_L					$^\circ C$
At distances $\geq 1/32$ in. (0.8 mm) from case for 10 s max.					235

* In accordance with JEDEC registration data.

TERMINAL DESIGNATIONS



JEDEC TO-213MA

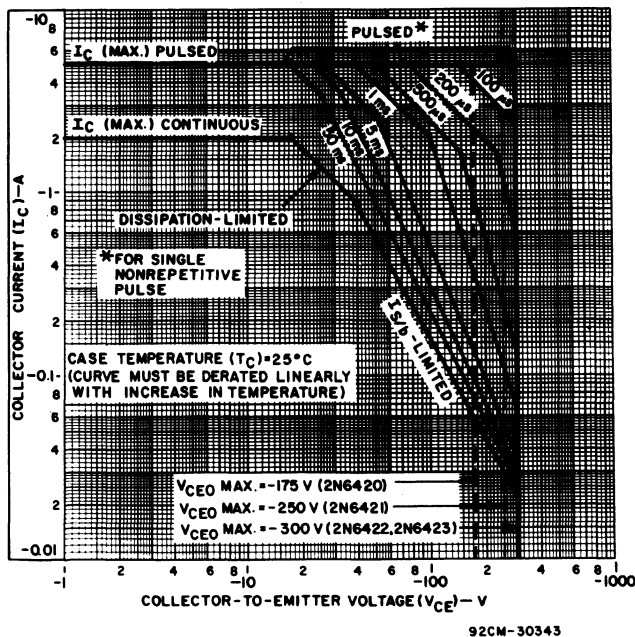


Fig. 1 - Maximum operating areas for all types at $T_C = 25^\circ C$.

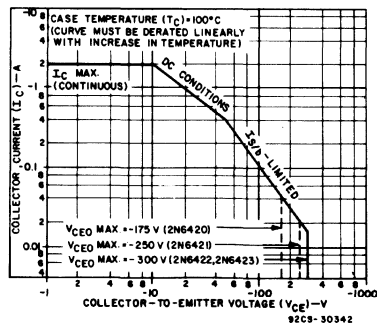


Fig. 2 - Maximum operating areas for all types, at $T_C = 100^\circ C$.

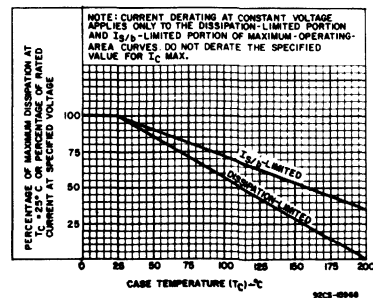


Fig. 3 - Derating curves for all types.

2N6420, 2N6421, 2N6422, 2N6423

ELECTRICAL CHARACTERISTICS, At Case Temperature (T_C) = 25°C
Unless Otherwise Specified

CHARACTERISTIC	TEST CONDITIONS				LIMITS						Units
	VOLTAGE V dc		CURRENT A dc		2N6420		2N6421 2N6422		2N6423		
	V _{CE}	V _{BE}	I _C	I _B	Min.	Max.	Min.	Max.	Min.	Max.	
* I _{CEO}	-150				-	-10	-	-5	-	-5	mA
* I _{CEX}	-225	1.5			-	-1	-	-	-	-	
2N6421	-340	1.5			-	-	-	-1	-	-	
2N6422	-450	1.5			-	-	-	-1	-	-	
* I _{CEX} T _C =150°C	-225	1.5			-	-3	-	-3	-	-5	mA
	-300	1.5			-	-	-	-	-	-	
* I _{EBO}		6	0		-	-5	-	-0.5	-	-0.5	V
* h _{FE}	-10		-0.1 ^a		40		40		40		
	-10		-0.5 ^a		40	200					
	-2		-0.75 ^a		-	-	-	-	10	100	
	-10		-0.75 ^a		-	-	-	-	30	150	
	-2		-1 ^a		-	-	8	80	-	-	
	-10		-1 ^a		10	-	25	100	-	-	
* V _{BE}	-10		-1 ^a		-	-1.4	-	-1.4	-	-1.4	V
* V _{BE(sat)}			-0.75 ^a -1 ^a	-0.075 -0.1	-	-1.4	-	-1.4	-	-1.8	
* V _{CE(sat)}			-0.75 ^a -1 ^a	-0.075 -0.125	-	-5	-	-0.75	-	-1	
* V _{CE0(sus)} ^b			-0.05 ^a -0.05 ^a -0.05 ^a	0 0 0	-175 - -300	-	-	-	-300 - -	-	
* I _{S/b}	-100				-0.15	-	-0.15	-	-0.15	-	A
* h _{fe} f = 5 MHz	-10		-0.2		2		2		3		pF
f = 1 kHz	-30		-0.1		25	350					
* C _{obo} V _{CB} =10V f = 1 MHz			0		-	180	-	180	-	180	
* t _r ^c			-0.75 -1	-0.075 ^d -0.1 ^d	-	-	-	-	3	0.5	μs
* t _s ^c			-0.75 -1	-0.075 ^d -0.1 ^d	-	-	-	-	4	6	
* t _f ^c			-0.75 -1	-0.075 ^d -0.1 ^d	-	-	-	-	3	3	
			-0.75 -1	-0.075 ^d -0.1 ^d	-	-	-	-	3	-	
R _{θJC}	-10		-1		-	5	-	5	-	5	°C/W

* In accordance with JEDEC registration data.
^a Pulsed: pulse duration = 300 μs, duty factor ≤ 2%.
^b CAUTION: The sustaining voltage V_{CE0} (sus)
MUST NOT be measured on a curve tracer.

^c V_{CC} = -200 V, t_p = 20 μs
^d -I_{B1} = I_{B2}

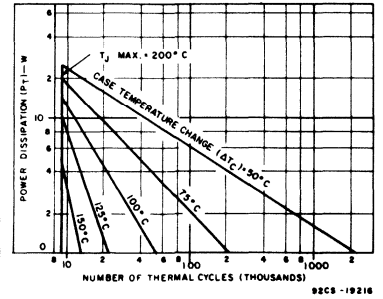


Fig. 4 - Thermal-cycling rating chart for all types.

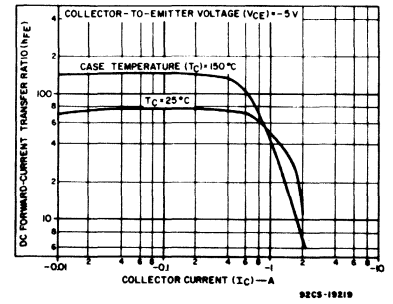


Fig. 5 - Typical dc beta characteristics for all types.

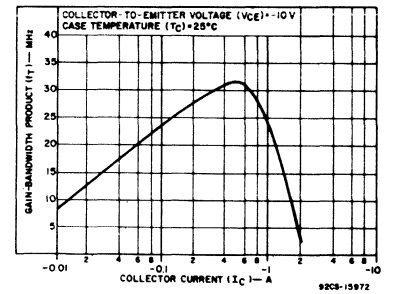


Fig. 6 - Typical gain-bandwidth product for all types.

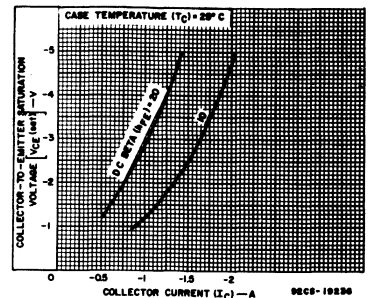


Fig. 7 - Typical saturation-voltage characteristics for all types.

2N6420, 2N6421, 2N6422, 2N6423

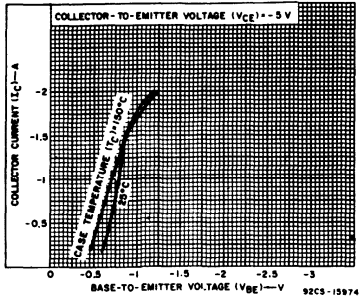


Fig. 8 - Typical transfer characteristics for all types.

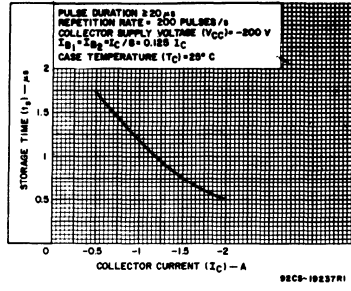


Fig. 9 - Typical storage time characteristic for all types.

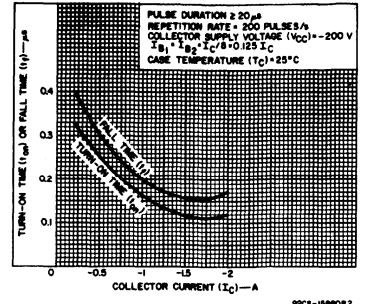


Fig. 10 - Typical turn-on time and fall-time characteristics for all types.

2N6477, 2N6478, RCA3441, RCA6263 Hometaxial-Base, Medium-Power Silicon N-P-N Transistors

Designed for Medium-Power Linear and Switching Service in Consumer, Automotive, and Industrial Applications

RCA 2N6477 and 2N6478 are hometaxial-base silicon n-p-n transistors intended for a wide variety of medium-to-high power, high-voltage applications. These devices, which are voltage extensions of the 2N5298 family, are especially useful in vertical output stages in color and black-and-white TV. The units differ in voltage ratings and in the currents at which parameters are controlled.

RCA3441 and RCA6263 are silicon n-p-n transistors intended for a wide variety of high-current applications. The hometaxial-base construction of these devices renders them highly resistant

to second breakdown over a wide range of operating conditions. The VERSAWATT case has a proven thermal-cycling capability. This capability is assured by real-time quality controls in our manufacturing locations. All these types are supplied in the JEDEC TO-220AB straight-lead version of the package. They are also available on special order in a variety of lead-form configurations. Two popular variations have leads formed to fit TO-66 sockets (specify formed lead No. 6201) or printed-circuit boards (specify formed lead No. 6207). Detailed information on these and other VERSAWATT outlines may be obtained from your RCA Sales Office.

Features:

- Maximum safe-area-of-operation curves
- Low saturation voltages
- High dissipation ratings
- Thermal-cycling rating curves

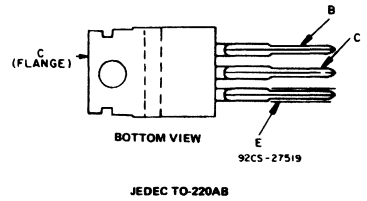
Applications:

- Series and shunt regulators
- High-fidelity amplifiers
- Power switching circuits
- Solenoid drivers
- Vertical output stages in color and B/W TV

MAXIMUM RATINGS, Absolute Maximum Values

	2N6477	2N6478	RCA6263	RCA3441		
COLLECTOR TO BASE VOLTAGE	V _{CB0}	140	160	140	180	v
COLLECTOR TO EMITTER SUSTAINING VOLTAGE	V _{CE(sus)}	120	140	120	140	v
	V _{CE0(sus)}	130	150	130	150	v
With external base-to-emitter resistance (R _{BE}) = 100 Ω	V _{CEV(sus)}	140	160	140	160	v
	V _{CEV(sus)}	140	160	140	160	v
With base open	V _{EB0}	5	5	7	7	v
With base reverse biased V _{BE} = -1.5 V	V _{CEV(sus)}	140	160	140	160	v
EMITTER TO BASE VOLTAGE	V _{EB0}	5	5	7	7	v
CONTINUOUS COLLECTOR CURRENT	I _C	2.5	2.5	3	3	A
PEAK COLLECTOR CURRENT	I _C	4	4	4	4	A
CONTINUOUS BASE CURRENT	I _B	1	1	2	2	A
TRANSISTOR DISSIPATION	P _T	50	50	36	36	W
At case temperatures up to 25°C		50	50	36	36	W
At case temperatures above 25°C		Derate linearly to 150°C				
TEMPERATURE RANGE		1.8	1.8	—	—	W/C
Storage and Operating (Junction)		Derate linearly at 0.0144		-65 to 150		°C
PIN TEMPERATURE (During Soldering)					235	°C
At distances ≥ 1/32 in. (0.8 mm) from seating plane for 10 s max						

TERMINAL DESIGNATIONS



* 2N- Series types in accordance with JEDEC registration data format JS-6 RDF-2.

ELECTRICAL CHARACTERISTICS, At Case Temperature (T_C) = 25°C unless otherwise specified

CHARACTERISTIC	SYMBOL	TEST CONDITIONS				LIMITS				UNITS
		VOLTAGE		CURRENT		2N6477		2N6478		
		V _{dc}	A _{dc}	I _C	I _B	MIN.	MAX.	MIN.	MAX.	
Collector-Cutoff Current: With base open	I _{CEO}	80			0	—	2	—	—	mA
		100			0	—	—	—	2	
	I _{CEV}	130	-1.5			—	2	—	—	
		150	-1.5			—	—	—	2	
At T _C = 150°C	I _{CEV}	120	-1.5			—	10	—	—	
At T _C = 150°C	I _{CEV}	140	-1.5			—	—	—	10	
Emitter-Cutoff Current	I _{EBO}		-5	0		—	2	—	2	mA
Collector-to-Emitter Sustaining Voltage: With base open	V _{CE0(sus)}			0.1*	0	120	—	140	—	v
				0.1*		130	—	150	—	
	V _{CEV(sus)}			0.1*		140	—	160	—	
				-1.5	0.1*	140	—	160	—	
DC Forward-Current Transfer Ratio	h _{FE}	4		1*		25	150	25	150	
		4		2.5*		5	—	5	—	
Collector-to-Emitter Saturation Voltage	V _{CE(sat)}			1*	0.1	—	1	—	1	
				2.5*	0.5	—	2	—	2	
Base-to-Emitter Voltage	V _{BE}	4		1*		—	1.8	—	1.8	
		4		2.5*		—	3	—	3	
Magnitude of Common-Emitter, Small-Signal, Short-Circuit Forward-Current Transfer Ratio: f = 40 kHz	h _{fe}	4		0.5		5	—	5	—	
		4		2.5*		—	—	—	—	
Gain-Bandwidth Product	f _T	4		0.5		200	—	200	—	kHz
Common-Emitter, Small-Signal, Short-Circuit Forward-Current Transfer Ratio: f = 1 kHz	h _{ie}	4		0.1		25	—	25	—	
		4		2.5*		—	—	—	—	
Thermal Resistance: Junction-to-Case	R _{θJC}					—	2.5	—	2.5	°C/W
						—	70	—	70	

* In accordance with JEDEC registration data format (JS-6 RDF-2).

* Pulsed: Pulse duration = 300 μs, duty factor = 1.8%.

CAUTION: The sustaining voltage V_{CE0(sus)}, V_{CEV(sus)}, and V_{CEV(sus)} MUST NOT be measured on a curve tracer.

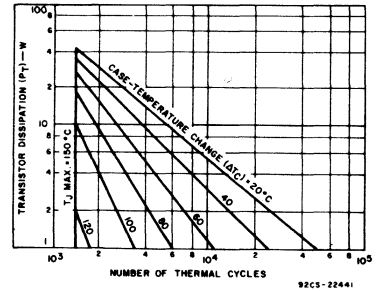


Fig. 1 - Thermal-cycling rating chart for 2N6477, 2N6478.

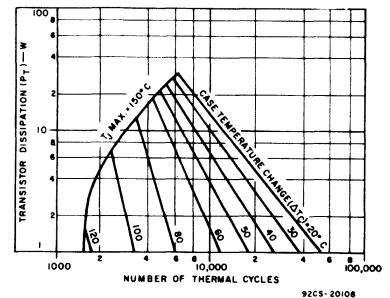


Fig. 2 - Thermal-cycling rating chart for RCA3441, RCA6263.

2N6477, 2N6478, RCA3441, RCA6263

ELECTRICAL CHARACTERISTICS, At Case Temperature (T_C) = 25°C unless otherwise specified

CHARACTERISTIC	SYMBOL	TEST CONDITIONS						LIMITS				UNITS
		VOLTAGE V dc			CURRENT A dc			RCA6263		RCA3441		
		V _{CE}	V _{EB}	V _{BE}	I _C	I _B	MIN.	MAX.	MIN.	MAX.		
Collector-Cutoff Current: With base open	I _{CEO}	100				0	-	5	-	-	-	mA
With base-emitter junction reverse-biased	I _{CEX}	120		-1.5			-	5	-	-	5	
At $T_C = 150^\circ\text{C}$	I _{CEX}	140		-1.5			-	10	-	-	10	
Emitter-Cutoff Current	I _{EBO}		5			0		2		2		mA
Collector-to-Emitter Sustaining Voltage: With base open	V _{CEO(sus)}				0.1 ^a	0	120	-	140	-	-	V
With external base-to- emitter resistance (R _{BE}) = 100 Ω	V _{CER(sus)}				0.1 ^a		130	-	150	-	-	
With base-emitter junction reverse-biased	V _{CEV(sus)}			-1.5	0.1 ^a		140	-	160	-	-	
DC Forward-Current Transfer Ratio	h _{FE}	4			0.5 ^a		20	150	20	150		
Collector-to-Emitter Saturation Voltage	V _{CE(sat)}				0.5 ^a	0.05 ^b	-	1.2	-	1.2		V
Base-to-Emitter Voltage	V _{BE}	4			0.5 ^a		-	2	-	2		V
Gain-Bandwidth Product	f _T	4			0.2		200	-	200	-		kHz
Common-Emitter, Small-Signal, Short- Circuit Forward- Current Transfer Ratio (f = 1 kHz)	h _{fe}	4			0.1		25	-	25	-		
Forward-Bias Second Breakdown Collector Current ^b (t ≥ 1 μs)	I _{S/b}	120					0.3	-	0.3	-		A
Thermal Resistance: Junction-to-Case	R _{θJC}						-	3.5	-	3.5		°C/W
Junction-to-Ambient	R _{θJA}						-	70	-	70		

^aPulsed: Pulse duration = 300 μs, duty factor = 1.8%.

^bPulsed: 1-second non-repetitive pulse.

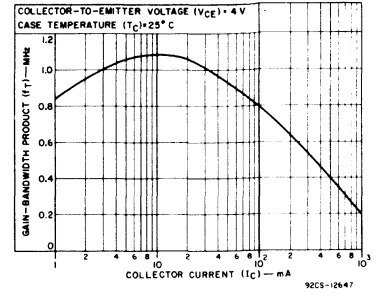


Fig. 3 - Typical gain-bandwidth product for all types.

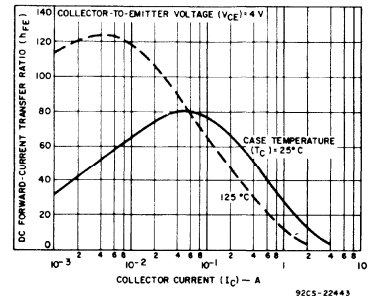


Fig. 4 - Typical dc beta characteristics for 2N6477.

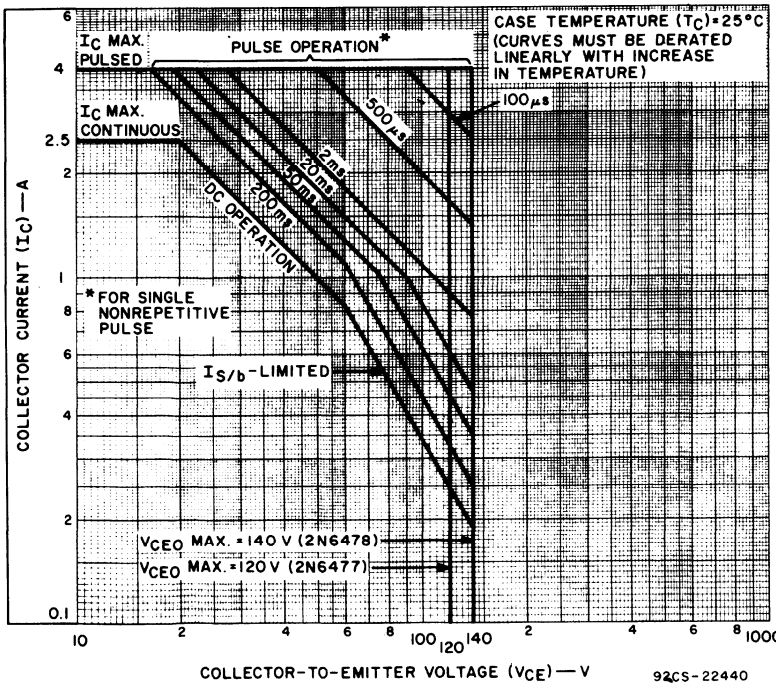


Fig. 6 - Maximum operating areas for 2N6477 and 2N6478.

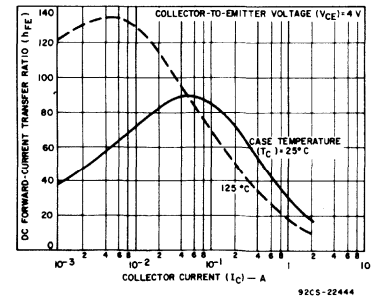


Fig. 5 - Typical dc beta characteristics for 2N6478.

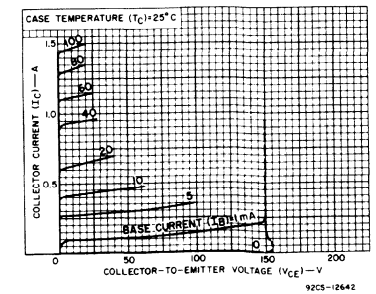


Fig. 7 - Typical output characteristics for 2N6478 and RCA3441.

2N6477, 2N6478, RCA3441, RCA6263

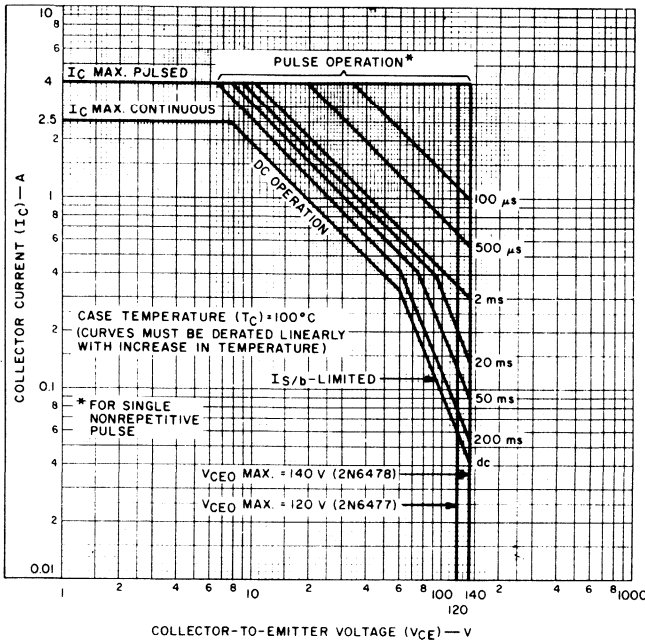


Fig. 8 - Maximum operating areas for 2N6477 and 2N6478.

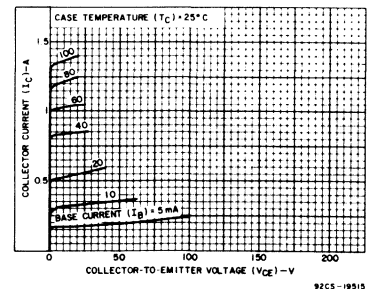


Fig. 9 - Typical output characteristics for 2N6477 and RCA6263.

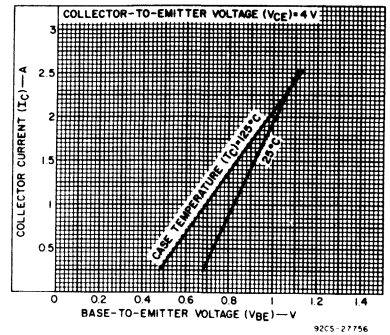


Fig. 10 - Typical transfer characteristics for 2N6477 and 2N6478.

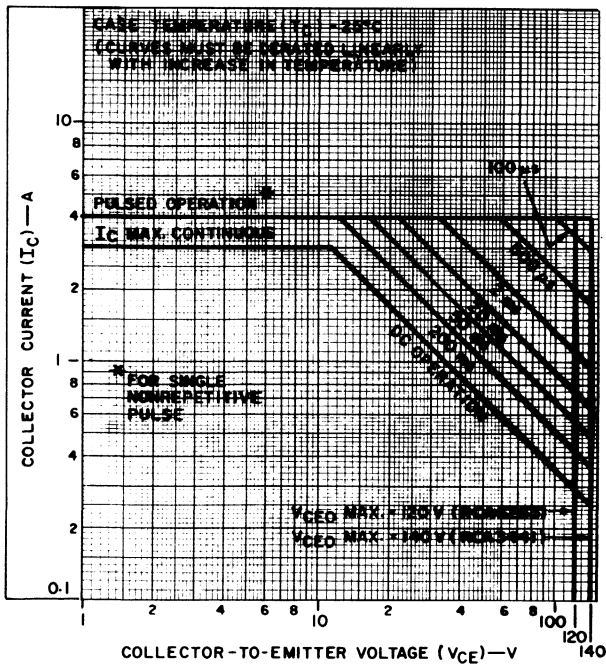


Fig. 11 - Maximum operating areas for RCA3441, RCA6263.

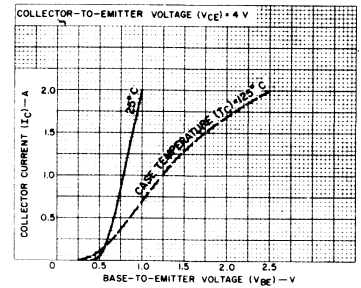


Fig. 12 - Typical transfer characteristics for RCA3441.

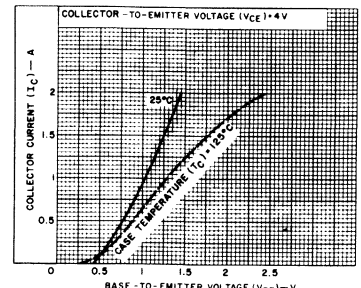


Fig. 13 - Typical transfer characteristics for RCA6263.

2N6479, 2N6480

Radiation-Hardened Silicon N-P-N Power Transistors

Epitaxial-Planar Types for Aerospace and Military Applications

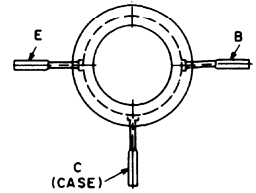
Rated for Operation in Radiation Environments with Cumulative Neutron Fluence Levels to 1×10^{14} Neutrons/cm² and Gamma Intensity to 1×10^8 Rad(Si)/s

The RCA-2N6479 and 2N6480* are epitaxial silicon n-p-n planar power-switching transistors. They are designed for aerospace applications in which they might be subjected to extreme neutron and gamma-ray exposure.

The 2N6479 and 2N6480 are intended for use in 5-to-10 ampere high-frequency power inverter service. They are supplied in hermetic flat 3/4-inch (19.05 mm) diameter packages with radial leads.

*Formerly RCA Dev. Nos. TA8007 and TA8007B, respectively.

TERMINAL DESIGNATIONS



92CS-27523

(RADIAL)

MAXIMUM RATINGS, Absolute-Maximum Values

	2N6479	2N6480	
* V _{CB0}	100	100	V
V _{CER(sus)} R _{BE} ≤ 100 Ω	80	100	V
* V _{CEX}	60	80	V
* V _{CEO(sus)}	60	80	V
* V _{EBO}	_____	6	V
* I _C	_____	12	A
I _{CM}	_____	25	A
* I _B	_____	5	A
* P _T : T _C ≤ 25°C	_____	87	W
T _C < 25°C	See Fig. 1 and 5		
* T _C = 100°C	_____	50	W
* T _J , T _{stg}	_____	-65 to 200	°C
* T _L : During soldering, at distances 1/32 in. (0.8 mm) from seating plane for 10 s max.	_____	230	°C

*In accordance with JEDEC registration data

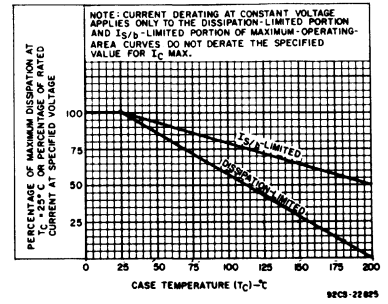


Fig. 1 - Derating curves for both types.

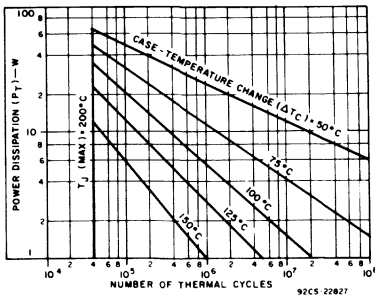


Fig. 2 - Thermal-cycling rating chart for both types.

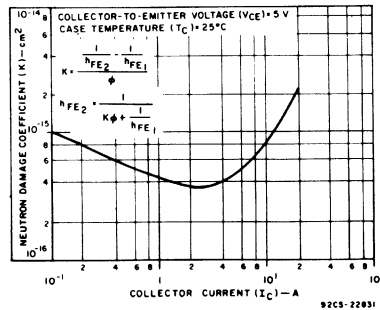


Fig. 3 - Typical 1-Me V-equivalent neutron damage coefficient as a function of collector current for both types.

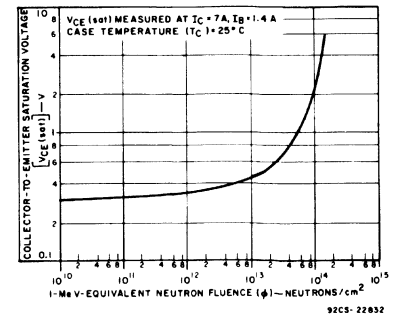


Fig. 4 - Typical collector-to-emitter saturation voltage as a function of 1-Me V-equivalent neutron fluence for both types.

2N6479, 2N6480**ELECTRICAL CHARACTERISTICS, At Case Temperature (T_C) = 25°C
PRE-RADIATION**

CHARACTERISTIC	TEST CONDITIONS				LIMITS		UNITS
	VOLTAGE V dc		CURRENT A dc		2N6479 2N6480		
	VCE	VBE	IC	IB	Min.	Max.	
ICBO	100 ^a				—	1	mA
ICES	60				—	200	μA
* ICEV	100	0			—	1	mA
($T_C = 100^\circ\text{C}$)	60	0			—	1	
* IEBO		—6			—	2	
VEBO (IE = 2 mA)					6	—	
* VCEO(sus) ^b			0.2 ^c		60	—	V
2N6479 2N6480			0.2 ^c		80	—	
VCE(sus) ^b (RBE = 100 Ω)			0.2 ^c		80	—	
2N6479 2N6480			0.2 ^c		100	—	
* hFE	2		12 ^c		20	300	
* VBE(sat)			12 ^c	1.2	—	1.5	V
* VCE(sat)			12 ^c	1.2	—	0.75	
IS/b (t = 1 s)	12				7.3	—	A
ES/b (RBE = 100 Ω, L = 100 μH)			5		1.25	—	mJ
* hfe (f = 10 MHz)	5 ^e		1		10	—	
f _T	5		1		100	—	MHz
C _{obo} (f = 1 MHz)	10 ^a				—	400	pF
* t _r	30 ^d		12	1.2	—	400	ns
* t _s	30 ^d		12	1.2 ^e	—	800	
* t _f	30 ^d		12	1.2 ^e	—	200	
R _{θJC}	10			5	—	2	°C/W

*In accordance with JEDEC registration data.

^aV_{CB} value.^bCAUTION: The sustaining voltages V_{CEO(sus)} and V_{CER(sus)} MUST NOT be measured on a curve tracer. These sustaining voltages should be measured by means of the test circuit shown in Fig. 10.^cPulsed; pulse duration ≤ 350 μs, duty factor ≤ 2%.^dV_{CC} value.^eI_{B1} = -I_{B2}.**TYPICAL CHARACTERISTIC DURING GAMMA EXPOSURE FOR DOSE RATES
OF LESS THAN 1 x 10⁸ RAD(SI)/sec**

CHARACTERISTIC	TEST CONDITIONS		LIMITS	UNITS
	VOLTAGE — V dc		For both Types	
	V _{CB}	V _{BE}	TYPICAL	
Collector-to-Base Charge Generation Constant (C)	20	0	5x10 ⁻⁸	Coulomb Rad

The charge generated in the depletion region of a transistor is proportional to the volume of the depletion region, the total dose, and the energy of the gamma radiation.

The primary base-collector photo current [I_{pp(base)}] = (C)γ, where γ is the gamma dose rate in Rad(Si)/s.

2N6479, 2N6480

POST-NEUTRON-RADIATION ELECTRICAL CHARACTERISTICS
AFTER EXPOSURE TO 5×10^{13} NEUTRONS/cm² (1 MeV equiv.), At Case
Temperature ($T_C = 25^\circ\text{C}$)

CHARACTERISTIC	TEST CONDITIONS				LIMITS		UNITS
	VOLTAGE V dc		CURRENT A dc		2N6479 2N6480		
	V _{CE}	V _{BE}	I _C	I _B	Min.	Max.	
* I _{CEV}	100	0			—	1.2	mA
* I _{EBO}		-5			—	2.2	
* V _{CEO(sus)} ^b	2N6479 2N6480		0.2 ^c 0.2 ^c		60 80	—	V
* h _{FE}	5		7 ^c		12	—	
* V _{BE(sat)}			7 ^c	1.4	—	1.5	V
* V _{CE(sat)}			7 ^c	1.4	—	1.5	
* h _{fe} (f = 10 MHz)	5		1		10		
* K ^a					—	9×10^{-16}	

^aIn accordance with JEDEC registration data.
^bCAUTION: The sustaining voltage V_{CEO(sus)} MUST NOT be measured on a curve tracer. This sustaining voltage should be measured by means of test circuit shown in Fig. 10.
^cPulsed; pulse duration $\leq 350 \mu\text{s}$, duty factor $\leq 2\%$.

$$\text{Damage constant } K = \frac{1}{h_{FE2}} - \frac{1}{h_{FE1}}$$

Where h_{FE1} = Beta prior to exposure
 h_{FE2} = Beta after exposure
 θ = Neutron fluence (1 MeV equiv.)

Knowing K, h_{FE2} may be calculated for other fluences using the relationship:

$$h_{FE2} = \frac{1}{K\theta + \frac{1}{h_{FE1}}}$$

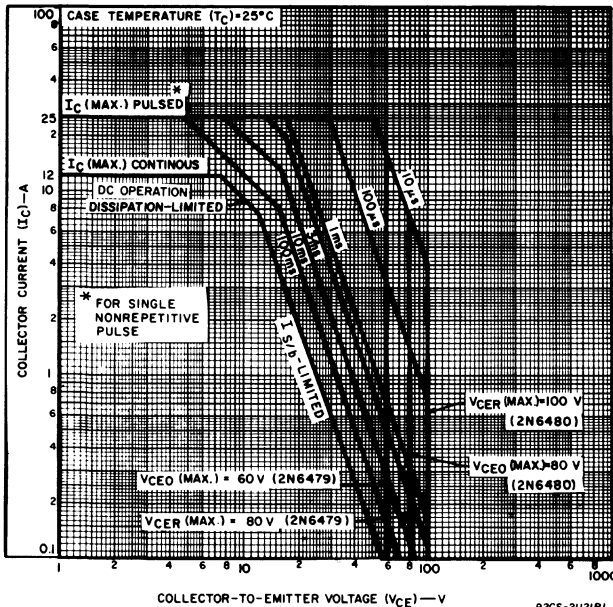


Fig. 5 - Maximum operating areas for both types ($T_C = 25^\circ\text{C}$).

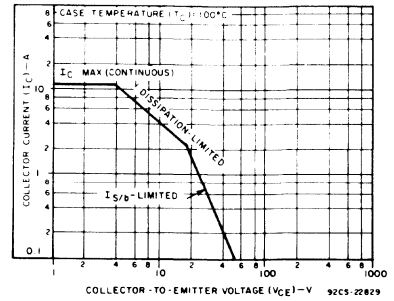


Fig. 6 - Maximum operating area for both types ($T_C = 100^\circ\text{C}$).

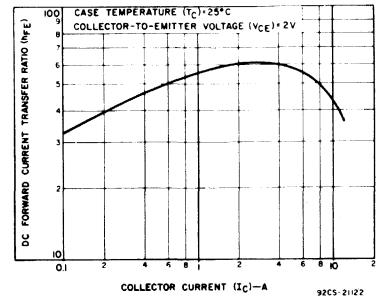


Fig. 7 - Typical dc beta characteristic for both types.

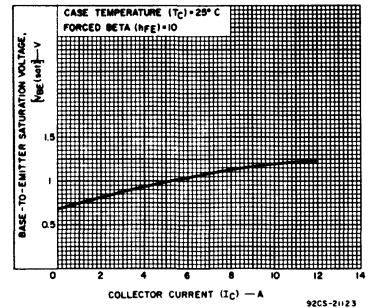


Fig. 8 - Typical base-to-emitter saturation voltage characteristic as a function of collector current for both types.

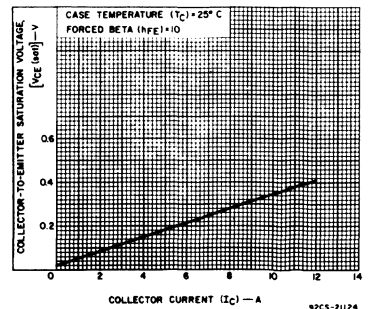


Fig. 9 - Typical collector-to-emitter saturation voltage characteristic as a function of collector current for both types.

2N6486-2N6491

15-A, 75-W, Silicon N-P-N and P-N-P Epitaxial-Base VERSAWATT Transistors

Complementary Pairs for General-Purpose Switching and Amplifier Applications

RCA-2N6486-2N6491*, inclusive, are epitaxial-base silicon transistors. The 2N6486, 2N6487, and 2N6488 are n-p-n complements of p-n-p types 2N6489, 2N6490, and 2N6491, respectively. All these devices are intended for a wide variety of medium-power switching and amplifier applications, and are particularly useful in high-fidelity amplifiers utilizing complementary-symmetry circuits.

* Formerly RCA Div. Nos. TA8325, TA8324, TA8323, TA8328, TA8327, and TA8326, respectively.

MAXIMUM RATINGS, Absolute-Maximum Values:

- **COLLECTOR-TO-BASE VOLTAGE** V_{CB0}
- **COLLECTOR-TO-EMITTER VOLTAGE:**
 - With 1.5 volts (V_{BE}) of reverse bias, and external base-to-emitter resistance (R_{BE}) = 100 Ω V_{CEX}
 - With external base-to-emitter resistance (R_{BE}) = 100 Ω V_{CER}
 - With base open V_{CEO}
- **EMITTER-TO-BASE VOLTAGE** V_{EBO}
- **CONTINUOUS COLLECTOR CURRENT** I_C
- **CONTINUOUS BASE CURRENT** I_B
- **TRANSISTOR DISSIPATION:** P_T
 - At case temperatures up to 25°C
 - At ambient temperatures up to 25°C
 - At case temperatures above 25°C
 - At ambient temperatures above 25°C
- **TEMPERATURE RANGE:**
 - Storage and operating (Junction)
- **LEAD TEMPERATURE (During soldering):**
 - At distance \geq 1/8 in. (3.17 mm) from seating plane for 10 s max.

These devices are supplied in the RCA VERSAWATT package in color-coded molded-silicone plastic; the 2N6489-2N6491 (p-n-p) devices are green, and the 2N6486-2N6488 (n-p-n) devices are gray. All are regularly supplied in the JEDEC TO-220AB straight-lead version of the package. They are also available on special order in a variety of lead-form configurations.

N-P-N	2N6486	2N6487	2N6488
P-N-P	2N6489*	2N6490*	2N6491*
V_{CB0}	50	70	90
V_{CEX}	50	70	90
V_{CER}	45	65	85
V_{CEO}	40	60	80
V_{EBO}	5	5	5
I_C	15	15	15
I_B	5	5	5
P_T	75	75	75
	1.8	1.8	1.8
	Derate linearly 0.6		W/°C
	Derate linearly 0.0144		W/°C
	-65 to +150		
	235		

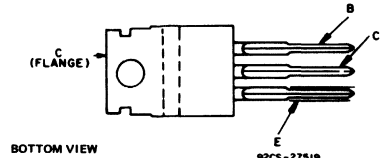
♦ For p-n-p devices, voltage and current values are negative.

* In accordance with JEDEC registration data format JS-6 RDF-2.

Features:

- Thermal-cycling ratings
- Maximum safe-area-of-operation curves
- Color-coded packages of molded-silicone plastic:
 - Green - p-n-p (2N6489, 2N6490, 2N6491)
 - Gray - n-p-n (2N6486, 2N6487, 2N6488)

TERMINAL DESIGNATIONS



BOTTOM VIEW

JEDEC TO-220AB

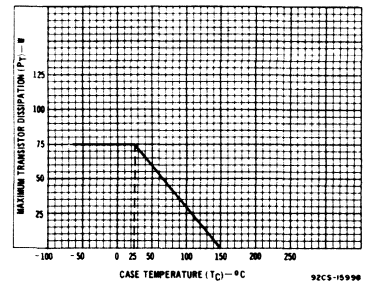


Fig. 1 - Derating chart for all types.

ELECTRICAL CHARACTERISTICS, At case temperature (T_C) = 25°C unless otherwise specified

CHARACTERISTIC	SYMBOL	TEST CONDITIONS			LIMITS						UNITS	
		VOLTAGE V dc	CURR A dc	I_C	2N6486 2N6489*		2N6487 2N6490*		2N6488 2N6491*			
					Min.	Max.	Min.	Max.	Min.	Max.		
Collector-Cutoff Current With external base-emitter resistance (R_{BE}) = 100 Ω	I_{CER}	35 75			500			500			500	μ A
• With base-emitter junction reverse biased and external base-to-emitter resistance (R_{BE}) = 100 Ω	I_{CEX}	45 65 85	-1.5 -1.5 -1.5		500			500			500	μ A
• At $T_C = 150^\circ\text{C}$		40 60 80	-1.5 -1.5 -1.5		5			5			5	mA
• With base open	I_{CEO}	20 30 40			1			1			1	mA
• Emitter-Cutoff Current	I_{EBO}		-5	0		1		1			1	mA
• DC Forward-Current Transfer Ratio	h_{FE}	4			5*	20	150	5*	20	150	5*	
• Collector-to-Emitter Sustaining Voltage With base open	$V_{CEO(sus)}$			0.2	40 ^b			60 ^b			80 ^b	V
• With external base-emitter resistance (R_{BE}) = 100 Ω	$V_{CER(sus)}$			0.2	45 ^b			65 ^b			85 ^b	V
• With base-emitter junction reverse biased and external base-to-emitter resistance (R_{BE}) = 100 Ω	$V_{CEX(sus)}$		1.5	0.2	50 ^b			70 ^b			90 ^b	V
• Base-to-Emitter Voltage	V_{BE}	4			5*	1.3	3.5	5*	1.3	3.5	5*	V
• Collector-to-Emitter Saturation Voltage $I_B = 0.5$ A $I_C = 5$ A	$V_{CE(sat)}$				5*	1.3	3.5	5*	1.3	3.5	5*	V
• Magnitude of Common-Emitter Small-Signal Short-Circuit Forward-Current Transfer Ratio: $f = 1$ MHz	$ h_{fe} $	4		1	5			5			5	
• Common-Emitter, Small-Signal, Short-Circuit, Forward-Current Transfer Ratio ($f = 1$ kHz)	h_{fe}	4		1	25			25			25	
• Thermal Resistance: Junction-to-case	$R_{\theta JC}$					1.67		1.67			1.67	°C/W
• Junction-to-ambient	$R_{\theta JA}$						70				70	°C/W

* In accordance with JEDEC registration data format (JS-6 RDF-2).

^b CAUTION: Sustaining voltages $V_{CEO(sus)}$, $V_{CER(sus)}$, and $V_{CEX(sus)}$ MUST NOT be measured on a curve tracer. (See Fig. 19.)

* Pulsed, pulse duration = 300 μ s, duty factor = 1.8%

♦ For p-n-p devices, voltage and current values are negative.

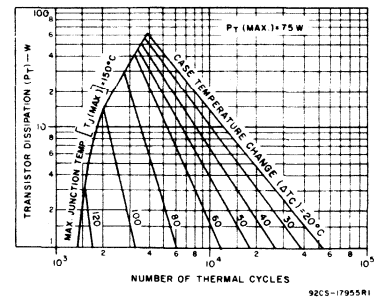


Fig. 2 - Thermal-cycling rating chart for all types

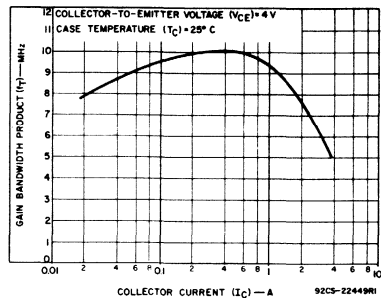


Fig. 3 - Typical gain-bandwidth product as a function of collector current for all types. ♦

♦ For p-n-p devices, voltage and current values are negative.

2N6486-2N6491

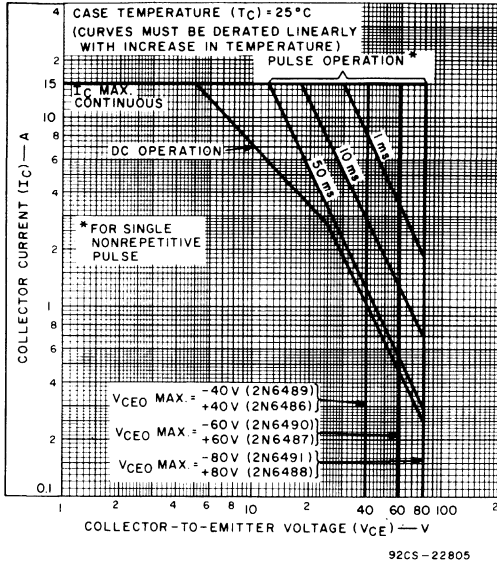


Fig. 4 - Maximum operating areas for all types.

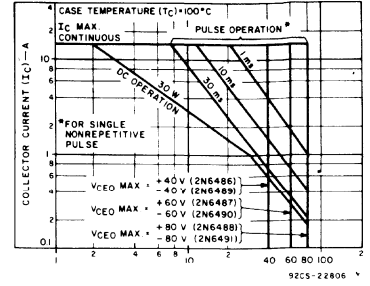


Fig. 5 - Maximum operating areas for all types.

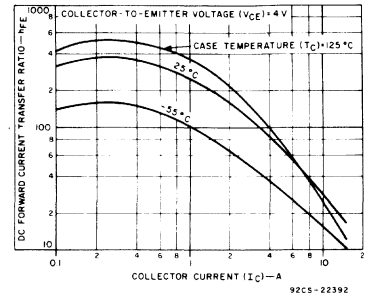


Fig. 6 - Typical dc beta characteristics for 2N6486, 2N6487, and 2N6488.

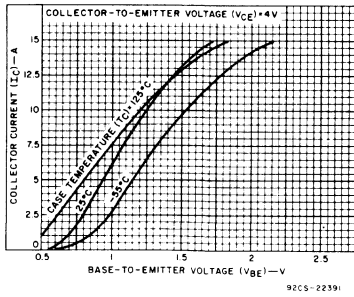


Fig. 7 - Typical transfer characteristics for all types.

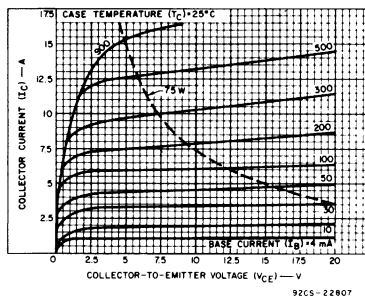


Fig. 8 - Typical output characteristics for all types.

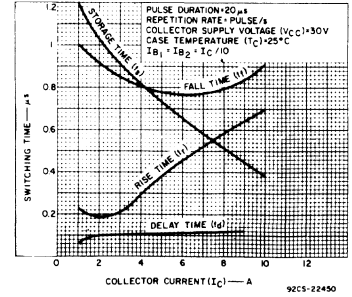


Fig. 9 - Typical saturated switching characteristics for 2N6486, 2N6487, and 2N6488.

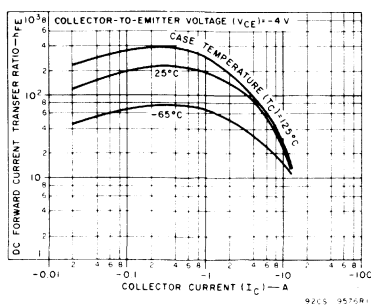


Fig. 10 - Typical dc beta characteristics for 2N6489, 2N6490, 2N6491.

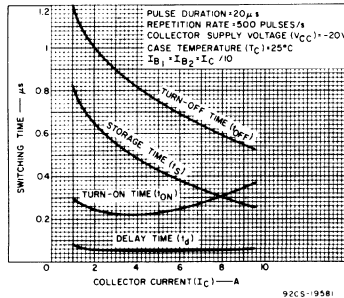


Fig. 11 - Typical saturated switching characteristics for 2N6489, 2N6490, and 2N6491.

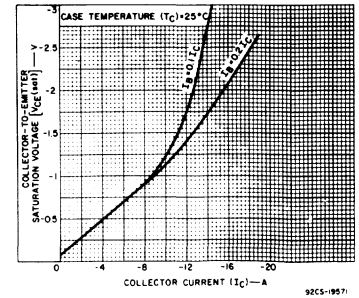


Fig. 12 - Typical collector-to-emitter saturation-voltage characteristics for all types.

♦ For p-n-p devices, voltage and current values are negative.

2N6510-2N6514

High-Voltage, High-Current, Silicon N-P-N Power Switching Transistors

For Switching Applications in Industrial Commercial and Military Equipment

The RCA-2N6510, -2N6511, -2N6512, -2N6513, and 2N6514* are epitaxial silicon n-p-n power transistors with pi-ni construction. They are especially designed for use in electronic ignition circuits and other applications requiring high voltage, high-energy, and fast-switching-speed capability.

These devices are hermetically sealed in a steel JEDEC TO-3 package. They differ from each other in breakdown-voltage ratings, leakage, and beta characteristics.

*Formerly RCA Dev. Nos. TA8847D, TA8847A, TA8847B, TA8847C, and TA8847E, respectively.

Features:

- Fast switching speed
- Epitaxial pi-ni construction
- Hermetic steel package—JEDEC TO-3
- Maximum-safe-area-of-operation curves
- Thermal-cycling rating chart

MAXIMUM RATINGS, Absolute-Maximum Values:

	2N6510	2N6511	2N6512	2N6513	2N6514	
*COLLECTOR-TO-BASE VOLTAGE	V _{CB0}	250	300	350	400	350
COLLECTOR-TO-EMITTER SUSTAINING VOLTAGE	V _{CE0}	250	300	350	400	350
With external base-to-emitter resistance R _{BE} = 50 Ω	V _{CE0} (sus)	200	250	300	350	300
* With base open	V _{CE0} (sus)	6	6	6	6	6
*EMITTER-TO-BASE VOLTAGE	V _{EB0}	7	7	7	7	7
*CONTINUOUS COLLECTOR CURRENT	I _C	3	3	3	3	3
*CONTINUOUS BASE CURRENT	I _B	10	10	10	10	10
*EMITTER CURRENT	I _E	10	10	10	10	10
*TRANSISTOR DISSIPATION:	P _T	120	120	120	120	120
At case temperatures up to 25°C						
At case temperatures above 25°C		See Figs. 1 and 2.				
*TEMPERATURE RANGE:						
Storage and Operating (Junction)		-65 to +200				
*PIN TEMPERATURE (During Soldering):						
At distances ≥ 1/32 in. (0.8 mm) from seating plane for 10 s max.		230				

*In accordance with JEDEC registration data format JC 25 R D F 1.

TERMINAL DESIGNATIONS

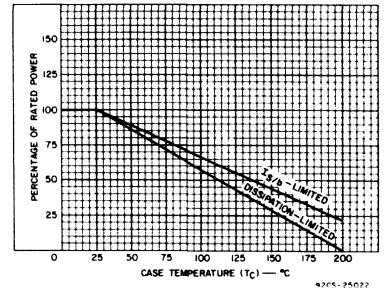
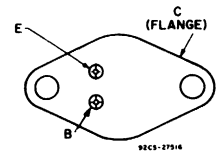


Fig. 2 - Derating curve for all types.

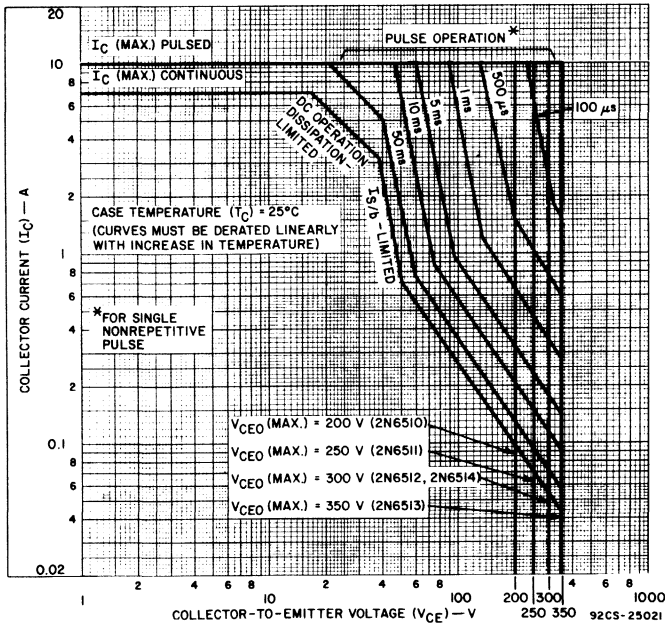


Fig. 1 - Maximum operating areas for all types.

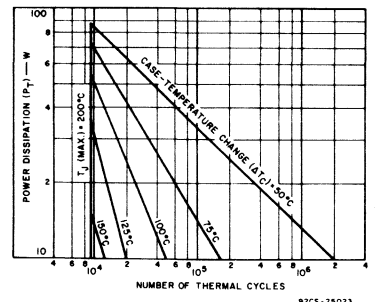


Fig. 3 - Thermal-cycling rating chart for all types.

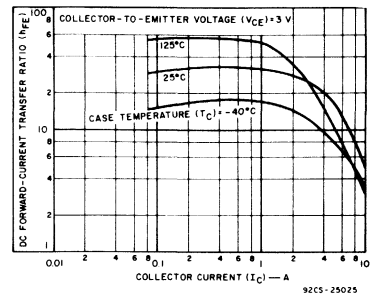


Fig. 4 - Typical dc beta characteristic for all types.

2N6510-2N6514

ELECTRICAL CHARACTERISTICS, Case Temperature (T_C) = 25°C Unless Otherwise Specified

CHARACTERISTIC	SYMBOL	TEST CONDITIONS				LIMITS						UNITS
		VOLTAGE V dc		CURRENT A dc		2N6512 2N6514			2N6513			
		V_{CE}	V_{BE}	I_C	I_B	Min.	Typ.	Max.	Min.	Typ.	Max.	
Collector-Cutoff Current: With base open	I_{CEO}	250 300				—	—	5	—	—	5	mA
With base-emitter junction reverse biased	I_{CEV}	350 400	-1.5 -1.5			—	—	5	—	—	5	mA
With base-emitter junction reverse biased, $T_C = 100^\circ\text{C}$		350 400	-1.5 -1.5			—	—	10	—	—	10	mA
Emitter-Cutoff Current	I_{EBO}		-6			—	—	3	—	—	3	mA
Collector-to-Emitter Sustaining Voltage: With base open	$V_{CEO(sus)}$			0.2		300 ^b	—	—	350 ^b	—	—	V
With external base-to-emitter resistance: $R_{BE} = 50 \Omega$	$V_{CER(sus)}$			0.2		350 ^b	—	—	400 ^b	—	—	V
Emitter-to-Base Voltage: $I_E = 3 \text{ mA}$	V_{EBO}					6	—	—	6	—	—	V
DC Forward-Current Transfer Ratio: 2N6512, 2N6513 2N6514	h_{FE}	3 3		4 ^a 5 ^a		10 10	—	50 50	10 10	—	50 50	
Base-to-Emitter Saturation Voltage: 2N6512, 2N6513 2N6514	$V_{BE(sat)}$			4 ^a 5 ^a	0.8 1	— —	— —	1.7 1.7	— —	— —	1.7 —	V
Collector-to-Emitter Saturation Voltage: 2N6512, 2N6513 2N6514 All types	$V_{CE(sat)}$			4 ^a 5 7	0.8 1 3	— — —	— — —	1.5 1.5 1.5	— — —	— — —	1.5 — 2.5	V
Output Capacitance: $V_{CB} = 10 \text{ V}$, $f = 1 \text{ MHz}$	C_{obo}					100	—	200	100	—	200	pF
Magnitude of Common Emitter, Small-Signal Short-Circuit, Forward-Current Transfer Ratio: $f = 1 \text{ MHz}$	$ h_{fe} $	10		1		3	—	9	3	—	9	MHz
Forward-Bias, Second-Breakdown Collector Current: $t = 1 \text{ s}$, nonrepetitive	$I_{S/b}$	38 200				3.16 0.1	— —	— —	3.16 0.1	— —	— —	A
Switching Time: ^c ($V_{CC} = 200 \text{ V}$, $I_{B1} = I_{B2}$): Delay Time: 2N6512, 2N6513 2N6514	t_d			4 5	0.8 1	— —	0.1 0.1	0.2 0.2	— —	0.1 —	0.2 —	μs
Rise Time: 2N6512, 2N6513 2N6514	t_r			4 5	0.8 1	— —	0.7 0.7	1.5 1.5	— —	0.7 —	1.5 —	μs
Storage Time: 2N6512, 2N6513 2N6514	t_s			4 5	0.8 1	— —	3 3	5 5	— —	3 —	5 —	μs
Fall Time: 2N6512, 2N6513 2N6514	t_f			4 5	0.8 1	— —	0.5 0.5	1.5 1.5	— —	0.5 —	1.5 —	μs
Thermal Resistance: Junction-to-Case	$R_{\theta JC}$	20		5		—	—	1.46	—	—	1.46	$^\circ\text{C/W}$

^a Minimum and maximum values and test conditions in accordance with JEDEC registration data format JC-25 RDF-1.

^b CAUTION: The sustaining voltages $V_{CEO(sus)}$ and $V_{CER(sus)}$ MUST NOT be measured on a curve tracer.

^c Pulsed; pulse duration = 300 μs , duty factor $\leq 2\%$.

^c See Figs. 10 and 11.

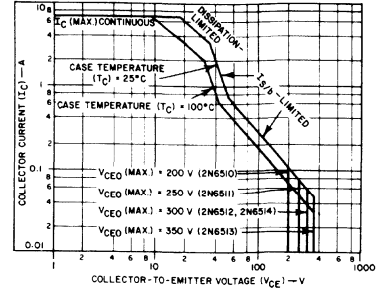


Fig. 5 - Maximum operating areas for all types at 25°C and 100°C.

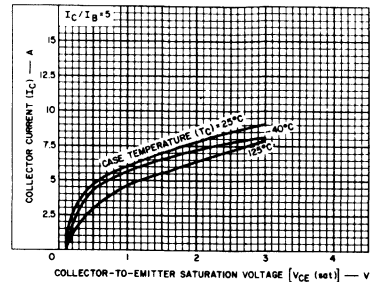


Fig. 6 - Typical collector-to-emitter saturation-voltage characteristics for all types.

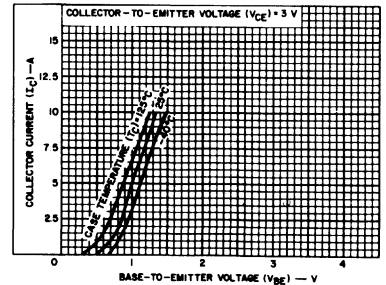


Fig. 7 - Typical transfer characteristics for all types.

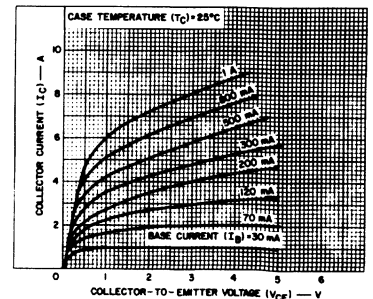


Fig. 8 - Typical output characteristics for all types.

2N6510-2N6514

ELECTRICAL CHARACTERISTICS, Case Temperature (T_C) = 25°C Unless Otherwise Specified

CHARACTERISTIC	SYMBOL	TEST CONDITIONS				LIMITS						UNITS	
		VOLTAGE V dc		CURRENT A dc		2N6510			2N6511				
		V_{CE}	V_{BE}	I_C	I_B	Min.	Typ.	Max.	Min.	Typ.	Max.		
Collector-Cutoff Current: With base open	I_{CEO}	150 200				—	—	5	—	—	—	5 ^a	mA
With base-emitter junction reverse biased	I_{CEV}	250 300	-1.5 -1.5			—	—	5	—	—	—	5	mA
		250 300	-1.5 -1.5			—	—	10	—	—	—	10	
Emitter-Cutoff Current	I_{EBO}		-6			—	—	3	—	—	—	3	mA
Collector-to-Emitter Sustaining Voltage: With base open	$V_{CEO(sus)}$			0.2		200 ^b	—	—	250 ^b	—	—	—	V
With external base-to- emitter resistance: $R_{BE} = 50 \Omega$	$V_{CER(sus)}$			0.2		250 ^b	—	—	300 ^b	—	—	—	V
Emitter-to-Base Voltage: $I_E = 3 \text{ mA}$	V_{EBO}					6	—	—	6	—	—	—	V
DC Forward Current Transfer Ratio	h_{FE}	3		3 ^a 4 ^a		10	—	50	—	—	—	—	
Base-to-Emitter Saturation Voltage	$V_{BE(sat)}$			3 ^a 4 ^a 7 ^a	0.6 0.8	—	—	1.7	—	—	—	—	V
Collector-to-Emitter Saturation Voltage	$V_{CE(sat)}$			3 ^a 4 ^a 7 ^a	0.6 0.8 3	—	—	1.5	—	—	—	1.5 2.5	V
Output Capacitance: $V_{CB} = 10 \text{ V}$, $f = 1 \text{ MHz}$	C_{obo}					100	—	200	100	—	—	200	pF
Magnitude of Common Emitter, Small-Signal Short-Circuit, Forward- Current Transfer Ratio: $f = 1 \text{ MHz}$	$ h_{fe} $	10		1		3	—	9	3	—	—	9	MHz
Forward-Bias, Second- Breakdown Collector Current: $t = 1 \text{ s}$, nonrepetitive	$I_{S/B}$	38 200				3.16 0.1	—	—	3.16 0.1	—	—	—	A
Switching Time: ^c ($V_{CC} = 200 \text{ V}$, $I_{B1} = I_{B2}$):													
Delay Time	t_d			3 4	0.6 0.8	—	0.1	0.2	—	—	0.1	0.2	μs
Rise Time	t_r			3 4	0.6 0.8	—	0.7	1.5	—	—	0.7	1.5	
Storage Time	t_s			3 4	0.6 0.8	—	3	5	—	—	3	5	
Fall Time	t_f			3 4	0.6 0.8	—	0.5	1.5	—	—	0.5	1.5	
Thermal Resistance: Junction-to-Case	$R_{\theta JC}$	20		5		—	—	1.46	—	—	—	1.46	

^a Minimum and maximum values and test conditions in accordance with JEDEC registration data format JC-25 RDF-1.

^b Pulsed; pulse duration = 300 μs , duty factor $\leq 2\%$.

^c CAUTION: The sustaining voltages $V_{CEO(sus)}$ and $V_{CER(sus)}$ MUST NOT be measured on a curve tracer. These sustaining voltages should be measured by means of the test circuit shown in Fig. 11.

^c See Figs. 8-10.

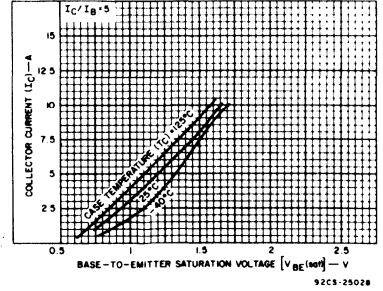


Fig. 9 - Typical base-to-emitter saturation-voltage characteristics for all types.

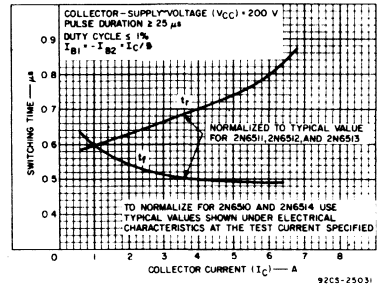


Fig. 10 - Typical rise and fall-time characteristics for all types.

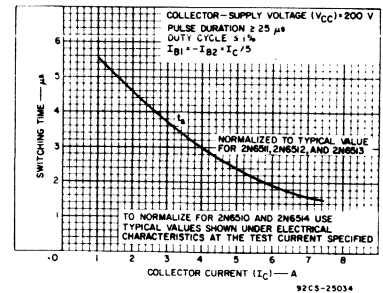


Fig. 11 - Typical storage-time characteristic for all types.

2N6530-2N6533

8-Ampere N-P-N Darlington Power Transistors

80, 100, 120 Volts, 60 Watts

Gain of 1000 at 5 A (2N6530, 2N6532)

Gain of 1000 at 3 A (2N6533)

Gain of 500 at 3 A (2N6531)

The RCA-2N6530, 2N6531, 2N6532, and 2N6533[®] are monolithic n-p-n silicon Darlington transistors designed for power applications at low and medium frequencies. The double epitaxial construction of these devices provides good forward and reverse second-breakdown characteristics. Their high gain allows them to be driven directly from integrated circuits.

• Formerly RCA Dev. Nos. TA8904C, TA8904D, TA8904B, and TA8904A, respectively.

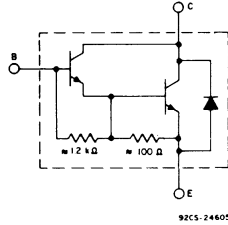


Fig. 1 - Schematic diagram for all types.

Features:

- Operate from IC without predriver
- Low leakage at high temperature
- High reverse second-breakdown capability

Applications:

- Power switching
- Hammer drivers
- Series and shunt regulators
- Audio amplifiers

MAXIMUM RATINGS, Absolute-Maximum Values:

	2N6530	2N6531	2N6532	2N6533	
*V _{CB0}	80	100	100	120	V
V _{CER(sus)}					
R _{BE} = 100 Ω	80	100	100	120	V
V _{CEO(sus)}	80	100	100	120	V
*V _{CEV(sus)}					
V _{BE} = -1.5 V	80	100	100	120	V
*V _{EBO}	5	5	5	5	V
*I _C	8	8	8	8	A
I _{CM}	15	15	15	15	A
*I _B	0.25	0.25	0.25	0.25	A
*P _T					
Up to 25°C	65	65	65	65	W
Above 25°C	See Fig. 2				
*T _J , T _{stg}	-65 to +150				°C
*T _L					
At distances ≥ 1/8 in. (3.17 mm) from case for 10 s max.	235				°C

* In accordance with JEDEC registration data format JS-6, RDF-4.

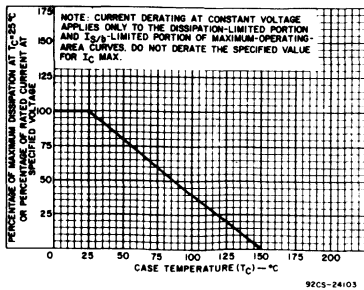
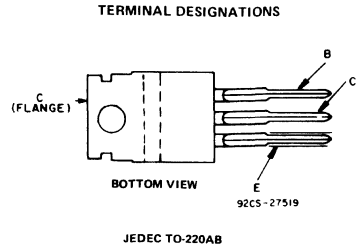


Fig. 2 - Dissipation derating curve for all types.

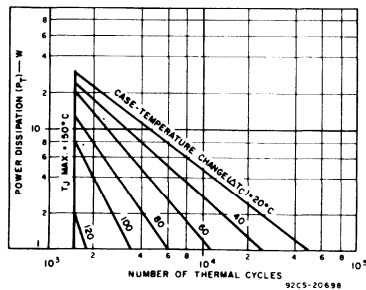


Fig. 3 - Thermal-cycling rating chart for all types.

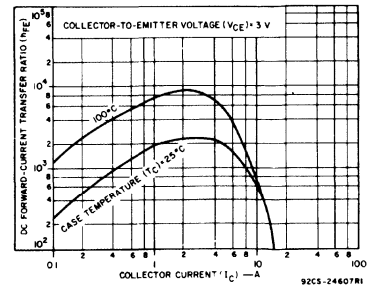


Fig. 4 - Typical dc beta characteristics for all types.

2N6530-2N6533

ELECTRICAL CHARACTERISTICS, At Case Temperature (T_C) = 25°C unless otherwise specified

CHARACTERISTIC SYMBOL	TEST CONDITIONS				LIMITS				UNITS
	VOLTAGE V dc		CURRENT A dc		2N6530		2N6531		
	V_{CE}	V_{BE}	I_C	I_B	Min.	Max.	Min.	Max.	
I_{CEO}	80 100			0 0	— —	1 —	— —	— 1	mA
I_{CEV}	80 100	-1.5 -1.5			— —	0.5 —	— 0.5		
$T_C = 125^\circ\text{C}$	80 100	-1.5 -1.5			— —	5 —	— 5		
I_{EBO}		-5	0		—	5	—	5	mA
h_{FE}	3 3 3		5 ^a 3 ^a 8 ^a		1,000 — 100	10,000 — 5,000	— 500 100	— 10,000 5,000	
$V_{CEO(sus)}$			0.2	0	80 ^b	—	100 ^b	—	V
$V_{CER(sus)}$ $R_{BE} = 100 \Omega$			0.2		80 ^b	—	100 ^b	—	
$V_{CEV(sus)}$		-1.5	0.2		80 ^b	—	100 ^b	—	
V_{BE}	3 3 3		5 ^a 3 ^a 8 ^a		— — —	2.8 — 4.5*	— — —	— 2.8 4.5*	V
$V_{CE(sat)}$			3 ^a 5 ^a 8 ^a	0.006 0.01 0.08	— — —	— 2 3*	— — —	3 — 3*	V
V_F			5 ^a 8 ^a		— —	— 5	— —	4 —	V
h_{fe} $f = 1 \text{ kHz}$	5		1		1,000	—	1,000	—	
$ h_{fe} $ $f = 1 \text{ MHz}$	5		1		20	—	20	—	
C_{obo} $V_{CB} = 10 \text{ V}$ $f = 1 \text{ MHz}$					—	200	—	200	pF
$I_{S/b}$ $t = 0.5 \text{ s}$, nonrep.	24				2.7	—	2.7	—	A
$E_{S/b}$ $L = 12 \text{ mH}$ $R_{BE} = 100 \Omega$		-1.5	4.5		120	—	120	—	mJ
$R_{\theta JC}$					—	1.92	—	1.92	°C/W

* In accordance with JEDEC registration data format JS-6, RDF-4.

^a Pulsed, pulse duration = 300 μs , duty factor $\leq 2\%$.

^b CAUTION: Sustaining voltages $V_{CEO(sus)}$, $V_{CER(sus)}$, and $V_{CEV(sus)}$ MUST NOT be measured on a curve tracer.

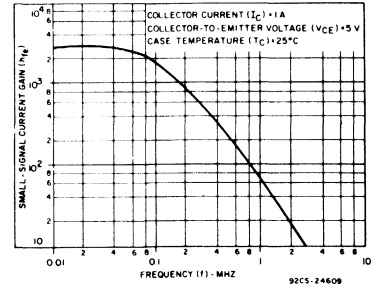


Fig. 5 - Typical small-signal current gain for all types.

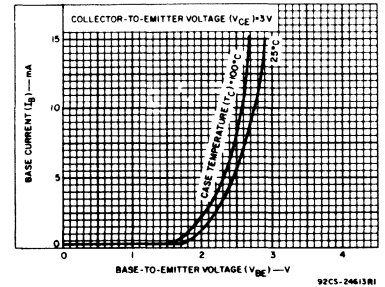


Fig. 6 - Typical input characteristics for all types.

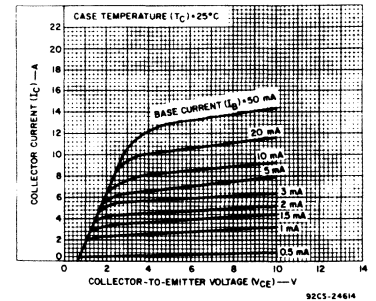


Fig. 7 - Typical output characteristics for all types.

2N6530-2N6533

ELECTRICAL CHARACTERISTICS, At Case Temperature (T_C) = 25°C unless otherwise specified

CHARACTERISTIC SYMBOL	TEST CONDITIONS				LIMITS				UNITS
	VOLTAGE V dc		CURRENT A dc		2N6532		2N6533		
	V_{CE}	V_{BE}	I_C	I_B	Min.	Max.	Min.	Max.	
I_{CEO}	120 100			0 0	— —	— 1	— —	— 1	mA
I_{CEV}	120 100	-1.5 -1.5			— —	— 0.5	— —	— —	
$T_C = 125^\circ\text{C}$	120 100	-1.5 -1.5			— —	— 5	— —	— —	
I_{EBO}		-5	0		—	5	—	5	mA
h_{FE}	3 3 3		3 ^a 5 ^a 8 ^a		— 1,000 100	— 10,000 5,000	1,000 — 100	10,000 — 5,000	
$V_{CEO(sus)}$			0.2	0	100 ^b	—	120 ^b	—	V
$V_{CER(sus)}$ $R_{BE} = 100 \Omega$			0.2		100 ^b	—	120 ^b	—	
$V_{CEV(sus)}$		-1.5	0.2		100 ^b	—	120 ^b	—	
V_{BE}	3 3 3		3 ^a 5 ^a 8 ^a		— — —	— 2.8 4.5*	— — —	2.8 — 4.5*	V
$V_{CE(sat)}$			3 ^a 5 ^a 8 ^a	0.006 0.01 0.08	— — —	— 2 3*	— — —	2 — 3*	V
V_F			5 ^a 8 ^a		— —	— 5	— —	4 —	V
h_{fe} $f = 1 \text{ kHz}$	5		1		1,000	—	1,000	—	
$ h_{fe} $ $f = 1 \text{ MHz}$	5		1		20	—	20	—	
C_{obo} $V_{CB} = 10 \text{ V}$ $f = 1 \text{ MHz}$					—	200	—	200	pF
$I_{S/b}$ $t = 0.5 \text{ s, nonrep.}$	24				2.7	—	2.7	—	A
$E_{S/b}$ $L = 12 \text{ mH}$ $R_{BE} = 100 \Omega$		-1.5	4.5		120	—	120	—	mJ
$R_{\theta JC}$					—	1.92	—	1.92	°C/W

* In accordance with JEDEC registration data format JS-6, RDF-4.

^a Pulsed, pulse duration = 300 μs , duty factor $\leq 2\%$.

^b CAUTION: Sustaining voltages $V_{CEO(sus)}$, $V_{CER(sus)}$, and $V_{CEV(sus)}$ MUST NOT be measured on a curve tracer.

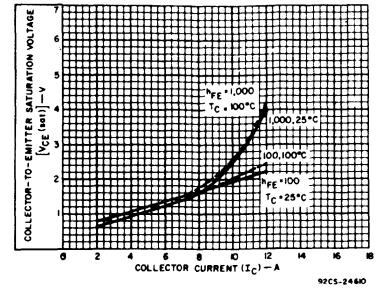


Fig. 8 - Typical saturation characteristics for all types.

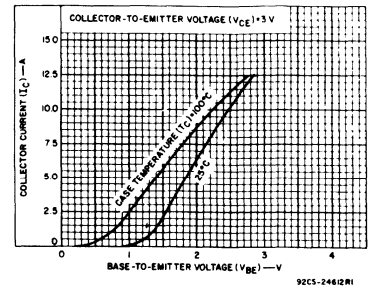


Fig. 9 - Typical transfer characteristics for all types.

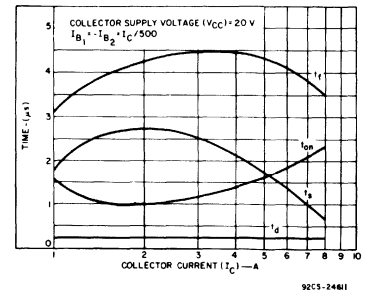


Fig. 10 - Typical saturated switching-time characteristics for all types.

2N6530-2N6533

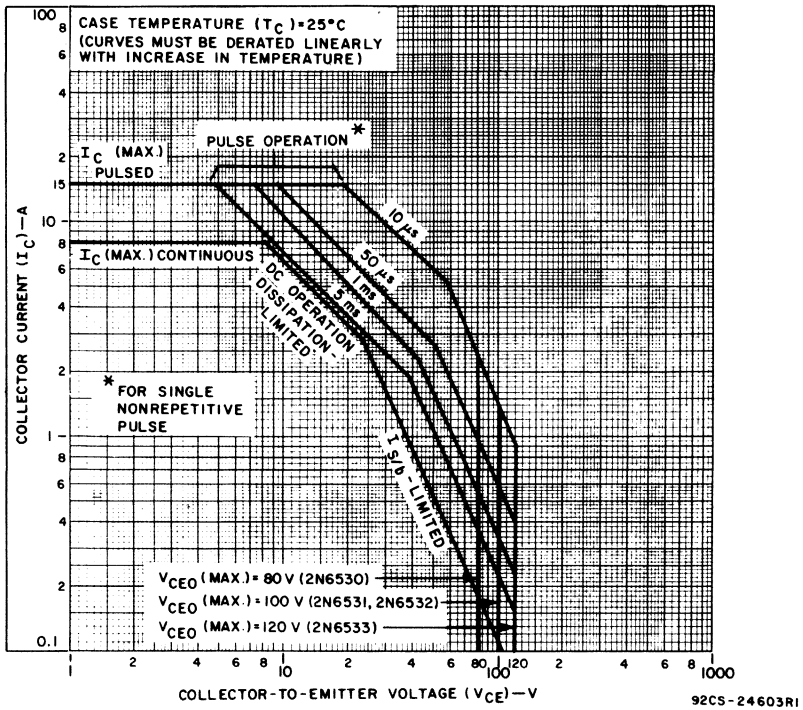


Fig. 11 - Maximum operating areas for all types at case temperature of 25°C.

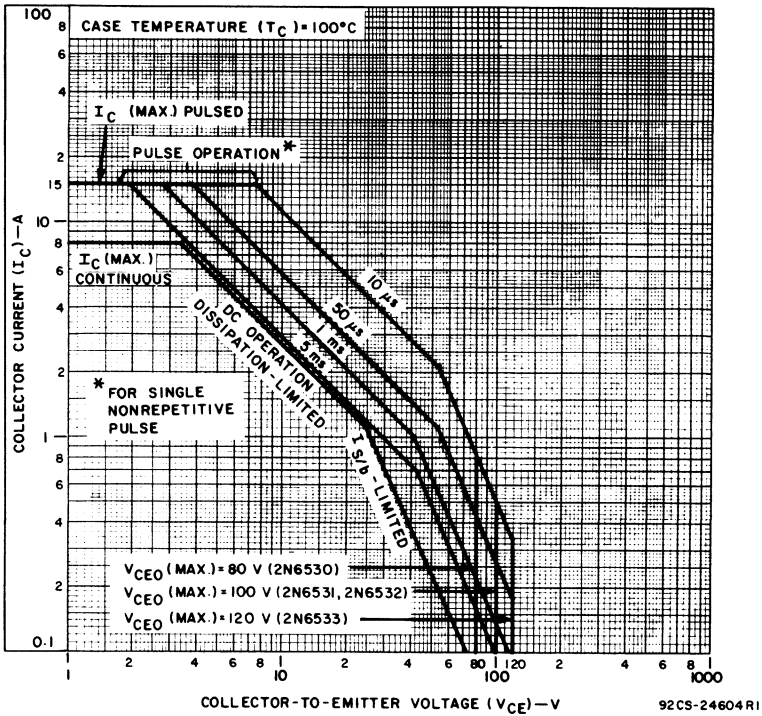


Fig. 12 - Maximum operating areas for all types at case temperature of 100°C.

2N6534-2N6537

8-Ampere N-P-N Darlington Power Transistors

80, 100, 120 Volts, 36 Watts
Gain of 1000 at 5 A (2N6534, 2N6536)

Gain of 1000 at 3 A (2N6537)
Gain of 500 at 3 A (2N6535)

Features:

- Operate from IC without predriver
- Low leakage at high temperature
- High reverse second-breakdown capability

Applications:

- Power switching ■ Audio amplifiers
- Hammer drivers ■ Series and shunt regulators

The RCA-2N6534, 2N6535, 2N6536, and 2N6537[●] are monolithic n-p-n silicon Darlington transistors designed for power applications at low and medium frequencies. The double epitaxial construction of these devices provides good forward and reverse second-breakdown characteristics. Their high gain allows them to be driven directly from integrated circuits.

These transistors are supplied in JEDEC TO-66 hermetic packages.

[●] Formerly RCA Dev. Nos. TA8941C, TA8941D, TA8941B, and TA8941A, respectively.

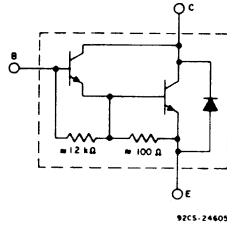
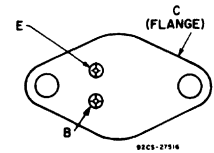


Fig. 1 - Schematic diagram for all types.

TERMINAL DESIGNATIONS



JEDEC TO-66

MAXIMUM RATINGS, Absolute-Maximum Values:

	2N6534	2N6535	2N6536	2N6537	
[*] V _{CB0}	80	100	100	120	V
V _{CER(sus)}					
R _{BE} = 100 Ω	80	100	100	120	V
V _{CEO(sus)}	80	100	100	120	V
[*] V _{CEV(sus)}					
V _{BE} = -1.5 V	80	100	100	120	V
[*] V _{EBO}	5	5	5	5	V
[*] I _C	8	8	8	8	A
I _{CM}	15	15	15	15	A
[*] I _B	0.25	0.25	0.25	0.25	A
[*] P _T					
Up to 25°C	36	36	36	36	W
Above 25°C	See Fig. 2				
[*] T _{stg}	-65 to +200				°C
[*] T _J	-65 to +150				°C
[*] T _L	At distances ≥ 1/8 in. (3.17 mm) from case for 10 s max.				235 °C

^{*} In accordance with JEDEC registration data format JS-6, RDF-4.

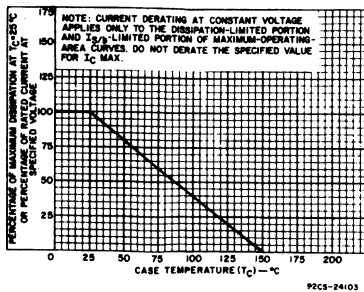


Fig. 2 - Dissipation derating curve for all types.

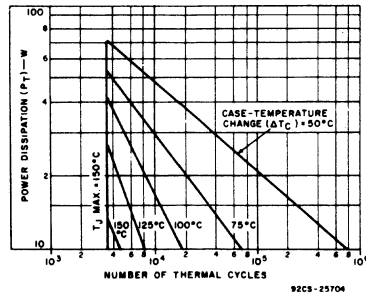


Fig. 3 - Thermal-cycling rating chart for all types.

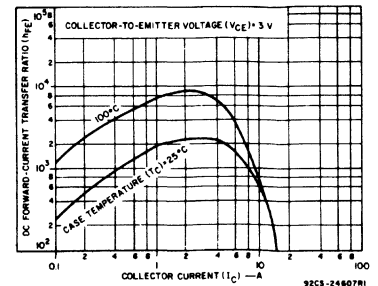


Fig. 4 - Typical dc beta characteristics for all types.

2N6534-2N6537

ELECTRICAL CHARACTERISTICS, At Case Temperature (T_C) = 25°C unless otherwise specified

CHARACTERISTIC SYMBOL	TEST CONDITIONS				LIMITS				UNITS
	VOLTAGE V dc		CURRENT A dc		2N6534		2N6535		
	V_{CE}	V_{BE}	I_C	I_B	Min.	Max.	Min.	Max.	
I_{CEO}	80 100		0 0		— —	1 —	— —	— 1	mA
I_{CEV}	80 100	-1.5 -1.5			— —	0.5 —	— —	— 0.5	
$T_C = 150^\circ\text{C}$	80 100	-1.5 -1.5			— —	5 —	— —	— 5	
I_{EBO}		-5	0		—	5	—	5	mA
h_{FE}	3 3 3		5 ^a 3 ^a 8 ^a		1,000 — 100	10,000 — 5,000	— — 100	— — 5,000	
$V_{CEO}(sus)$			0.2	0	80 ^b	—	100 ^b	—	V
$V_{CER}(sus)$ $R_{BE} = 100 \Omega$			0.2		80 ^b	—	100 ^b	—	
$V_{CEV}(sus)$		-1.5	0.2		80 ^b	—	100 ^b	—	
V_{BE}	3 3 3		5 ^a 3 ^a 8 ^a		— — —	2.8 — 4.5*	— — —	— 2.8 4.5*	V
$V_{CE}(sat)$			3 ^a 5 ^a 8 ^a	0.006 0.01 0.08	— — —	— 2 3*	— — —	3 — 3*	V
V_F			5 ^a 8 ^a		— —	— 5	— —	— 4	V
h_{fe} $f = 1 \text{ kHz}$	5		1		1,000	—	1,000	—	
$ h'_{fe} $ $f = 1 \text{ MHz}$	5		1		20	—	20	—	
C_{obo} $V_{CB} = 10 \text{ V}$ $f = 1 \text{ MHz}$					—	200	—	200	pF
$I_{S/b}$ $t = 1 \text{ s, nonrep.}$	34				1.06	—	1.06	—	A
$E_{S/b}$ $L = 12 \text{ mH}$ $R_{BE} = 100 \Omega$		-1.5	4.5		120	—	120	—	mJ
$R\theta_{JC}$					—	3.5	—	3.5	°C/W

* In accordance with JEDEC registration data format JS-6, RDF-4.

^a Pulsed, pulse duration = 300 μs , duty factor $\leq 2\%$.

^b CAUTION: Sustaining voltages $V_{CEO}(sus)$, $V_{CER}(sus)$, and $V_{CEV}(sus)$ MUST NOT be measured on a curve tracer.

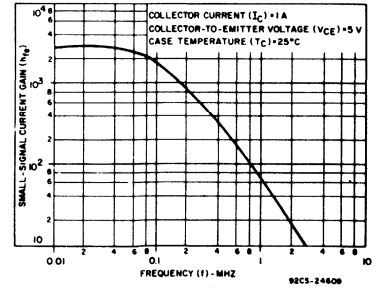


Fig. 5 - Typical small-signal current gain for all types.

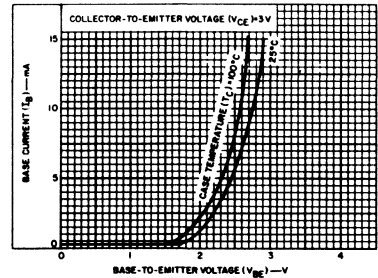


Fig. 6 - Typical input characteristics for all types.

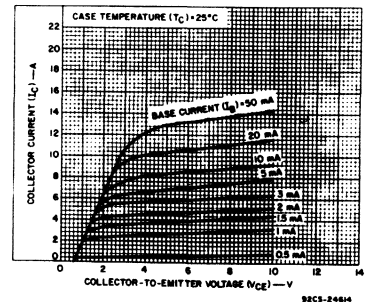


Fig. 7 - Typical output characteristics for all types.

2N6534-2N6537

ELECTRICAL CHARACTERISTICS, At Case Temperature (T_C) = 25°C unless otherwise specified

CHARACTERISTIC SYMBOL	TEST CONDITIONS				LIMITS				UNITS
	VOLTAGE V dc		CURRENT A dc		2N6536		2N6537		
	V_{CE}	V_{BE}	I_C	I_B	Min.	Max.	Min.	Max.	
I_{CEO}	120 100			0 0	— —	— 1	— —	1 —	mA
I_{CEV}	120 100	-1.5 -1.5			— —	— 0.5	— —	0.5 —	
$T_C = 150^\circ\text{C}$	120 100	-1.5 -1.5			— —	— 5	— —	5 —	
I_{EBO}		-5	0		—	5	—	5	mA
h_{FE}	3 3 3		3^a 5^a 8^a		— 1,000 100	— 10,000 5,000	1,000 — 100	10,000 — 5,000	
$V_{CEO(sus)}$			0.2	0	100^b	—	120^b	—	V
$V_{CER(sus)}$ $R_{BE} = 100 \Omega$			0.2		100^b	—	120^b	—	
$V_{CEV(sus)}$		-1.5	0.2		100^b	—	120^b	—	
V_{BE}	3 3 3		3^a 5^a 8^a		— — —	— 2.8 4.5*	— — —	2.8 — 4.5*	V
$V_{CE(sat)}$			3^a 5^a 8^a	0.006 0.01 0.08	— — —	— 2 3*	— — —	2 — 3*	V
V_F			5^a 8^a		— —	— 5	— —	4 —	V
h_{fe} $f = 1 \text{ kHz}$	5		1		1,000	—	1,000	—	
$ h_{fe} $ $f = 1 \text{ MHz}$	5		1		20	—	20	—	
C_{obo} $V_{CB} = 10 \text{ V}$ $f = 1 \text{ MHz}$					—	200	—	200	pF
I_S/b $t = 1 \text{ s}$, nonrep.	34				1.06	—	1.06	—	A
E_S/b $L = 12 \text{ mH}$ $R_{BE} = 100 \Omega$		-1.5	4.5		120	—	120	—	mJ
$R_{\theta JC}$					—	3.5	—	3.5	$^\circ\text{C/W}$

* In accordance with JEDEC registration data format JS-6, RDF-4.

^a Pulsed, pulse duration = 300 μs , duty factor $\leq 2\%$.

^b CAUTION: Sustaining voltages $V_{CEO(sus)}$, $V_{CER(sus)}$, and $V_{CEV(sus)}$ MUST NOT be measured on a curve tracer.

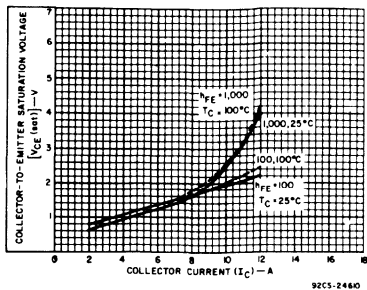


Fig. 8 - Typical saturation characteristics for all types.

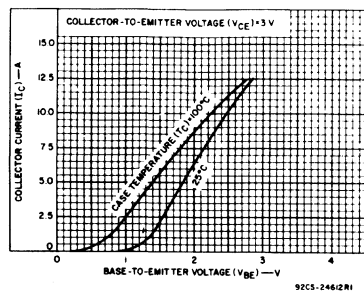


Fig. 9 - Typical transfer characteristics for all types.

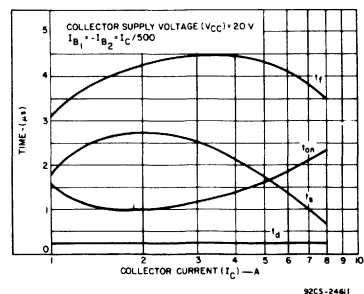


Fig. 10 - Typical saturated switching-time characteristics for all types.

2N6534-2N6537

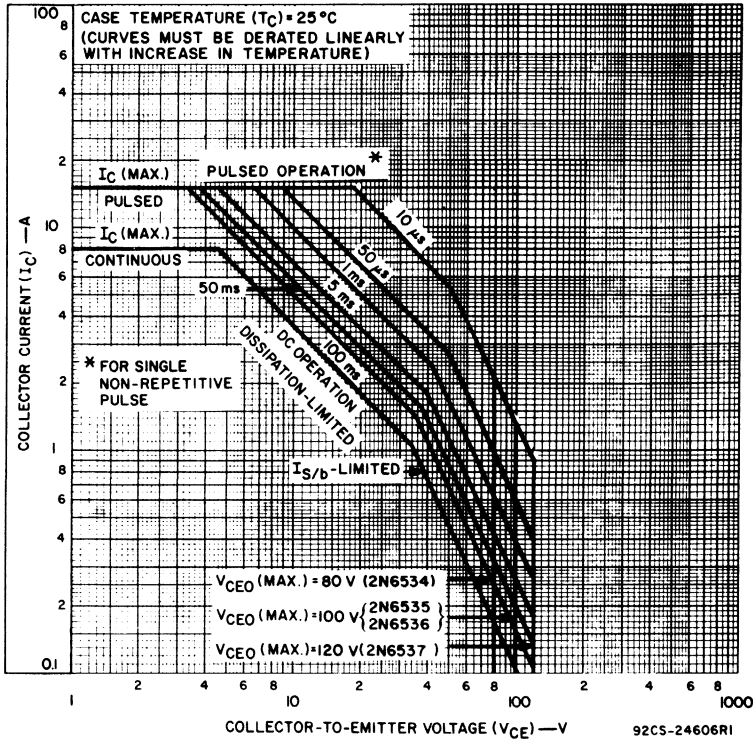


Fig. 11 - Maximum operating areas for all types at case temperature of 25°C.

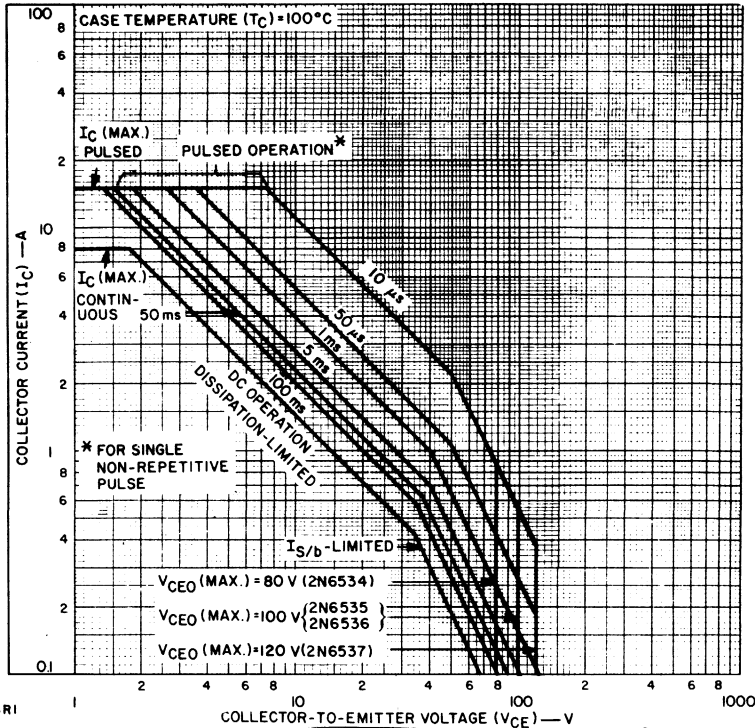


Fig. 12 - Maximum operating areas for all types at case temperature of 100°C.

2N6542, 2N6544, 2N6546

3-, 5-, and 10-A Power-Switching Transistors

High-Voltage N-P-N Types for Off-Line Power Supplies and Other High-Voltage Switching Applications

The RCA-2N6542, 2N6544, and 2N6546 series of silicon n-p-n power transistors feature high-voltage capability, fast switching speeds, and low saturation voltages, together with high safe-operating area (SOA) ratings. They are specially designed for off-line power supplies, converter circuits and pulse-width-modulated regulators. These high-voltage, high-speed transistors are 100-per-cent

tested for parameters that are essential to the design to high-power switching circuits. Switching times, including inductive turn-off time, and saturation voltages are characterized at 100°C; as well as at 25°C, to provide information necessary for worst-case design.

The 2N6542, 2N6544 and 2N6546 transistors are supplied in steel JEDEC TO-204MA hermetic packages.

Features:

- 100% High Temperature Tested for 100°C Parameters
- Fast Switching Speed
- High Voltage Rating:
V_{CEX} = 350 V
- Low V_{CE(sat)} at I_C = 3-, 5-, and 10-A
- Steel Hermetic TO-204MA Package

Applications:

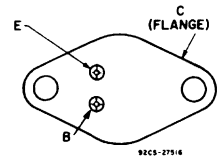
- Off-Line Power Supplies
- High Voltage Inverters
- Switching Regulators

MAXIMUM RATINGS, Absolute-Maximum Values:

	2N6542	2N6544	2N6546	
* V _{CBO}		650		V
* V _{CEV} V _{BE} = -1.5 V		650		V
* V _{CEX} (Clamped) V _{BE} = -1.5 V		350		V
* V _{CEO}		300		V
* V _{EBO}		9		V
* I _{C(sat)}	3	5	10	A
* I _C	5	8	15	A
* I _{CM}	10	16	30	A
* I _B	5	8	10	A
* P _T				W
T _C up to 25°C	100	125	175	W
T _C above 25°C, derate linearly	0.57	0.714	1	W/°C
* T _{stg} , T _J		-65 to 200		°C
* T _L At distance ≥ 1/8 in. (3.17 mm) from seating plane for 5 s max.		275		°C

* In accordance with JEDEC registration data.

TERMINAL DESIGNATIONS



JEDEC TO-204MA

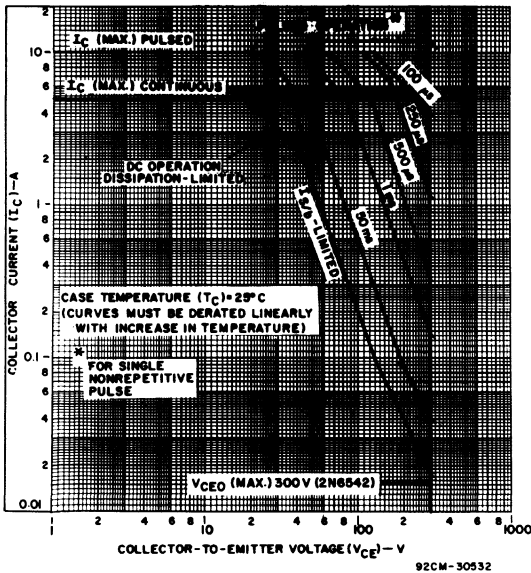


Fig. 1 - Maximum operating areas for type 2N6542 (T_C = 25°C).

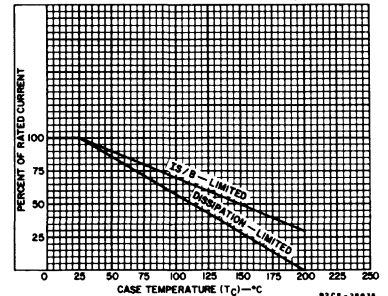


Fig. 2 - Dissipation and I_S/I_B derating curves for all types.

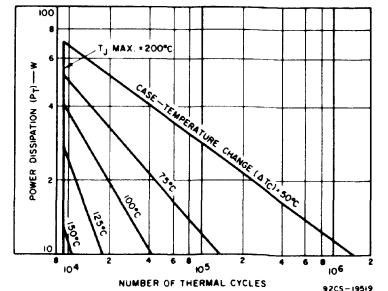


Fig. 3 - Thermal-cycling chart for type 2N6542.

2N6542, 2N6544, 2N6546

ELECTRICAL CHARACTERISTICS

CHARACTERISTIC	TEST CONDITIONS				LIMITS						Units
	VOLTAGE V dc		CURRENT A dc		2N6542		2N6544		2N6546		
	V _{CE}	V _{BE}	I _C	I _B	Min.	Max.	Min.	Max.	Min.	Max.	
<i>T_C = 25°C</i>											
* I _{CEV}	650	-1.5			-	0.5	-	0.5	-	1	mA
* I _{EBO}		-9	0		-	1	-	1	-	1	
* V _{CE0(sus)} ^b			0.1 ^a		300	-	300	-	300	-	V
* h _{FE}	2		3 ^a		7	35	-	-	-	-	
	2		1.5 ^a		12	60	-	-	-	-	
	3		5 ^a		-	-	7	35	-	-	
	3		2.5 ^a		-	-	12	60	-	-	
	2		10 ^a		-	-	-	-	6	30	
	2		5 ^a		-	-	-	-	12	60	
* V _{BE(sat)}			3 ^a	0.6	-	1.4	-	-	-	-	V
			5 ^a	1	-	-	-	1.6	-	-	
			10 ^a	2	-	-	-	-	-	1.6	
* V _{CE(sat)}			3 ^a	0.6	-	1	-	-	-	-	V
			5 ^a	1	-	5	-	1.5	-	-	
			8 ^a	2	-	-	-	5	-	-	
			10 ^a	2	-	-	-	-	-	1.5	
			15 ^a	3	-	-	-	-	-	5	
* I _{S/b} t = 1 s	100				0.2	-	0.2	-	0.2	-	A
* f _T f = 1 MHz	10		0.2		6	28	-	-	-	-	MHz
	10		0.3		-	-	6	28	-	-	
	10		0.5		-	-	-	-	6	28	
* C _{obo} f = 1 MHz	10 ^d				50	200	75	300	125	500	pF
* t _d ^e			3	0.6	-	0.05	-	-	-	-	μs
			5	1	-	-	-	0.05	-	-	
			10	2	-	-	-	-	-	0.05	
* t _r ^e			3	0.6	-	0.7	-	-	-	-	μs
			5	1	-	-	-	1	-	-	
			10	2	-	-	-	-	-	1	
* t _s ^e			3	0.6	-	4	-	-	-	-	μs
			5	1	-	-	-	4	-	-	
			10	2	-	-	-	-	-	4	
* t _f ^e			3	0.6	-	0.8	-	-	-	-	μs
			5	1	-	-	-	1	-	-	
			10	2	-	-	-	-	-	0.7	

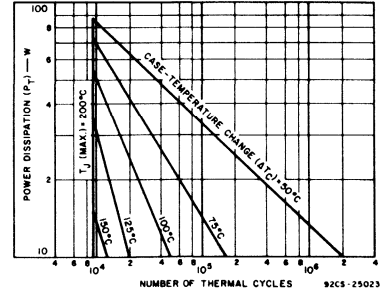


Fig. 4 - Thermal-cycling chart for type 2N6544.

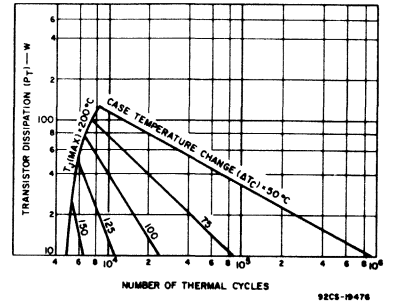


Fig. 5 - Thermal-cycle rating chart for type 2N6546.

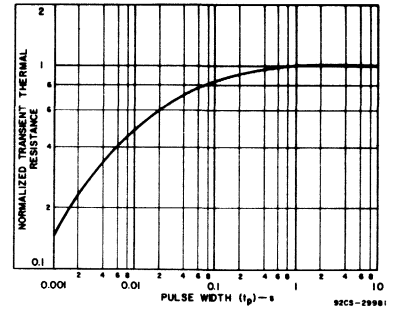


Fig. 6 - Typical thermal-response characteristic for types 2N6542 and 2N6544.

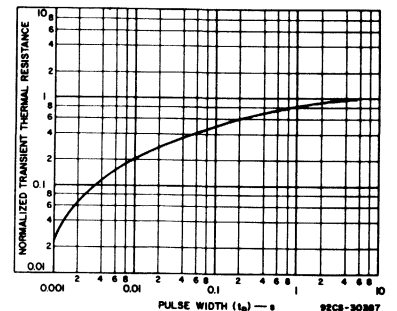


Fig. 7 - Typical thermal-response characteristic for type 2N6546.

2N6542, 2N6544, 2N6546

ELECTRICAL CHARACTERISTICS

CHARACTERISTIC	TEST CONDITIONS				LIMITS						Units
	VOLTAGE		CURRENT		2N6542		2N6544		2N6546		
	V _{CE}	V _{BE}	I _C	I _B	Min.	Max.	Min.	Max.	Min.	Max.	

T_C = 100°C

* I _{CEV}	650	-1.5			-	2.5	-	2.5	-	4	mA
* I _{CER} R _{BE} = 50 Ω	650				-	3	-	3	-	5	
* V _{CEX(sus)} ^{b,c} V _{CC} = 20 V L = 180 μH, R _C = 0.05 Ω V _{clamp} = Rated V _{CEX}			2.6 ^a		350	-	-	-	-	-	V
			4.5 ^a		-	-	350	-	-	-	
			8 ^a		-	-	-	-	350	-	
											V
			5 ^a		200	-	-	-	-	-	
			8 ^a		-	-	200	-	-	-	
			15 ^a		-	-	-	-	200	-	
* V _{BE(sat)}			3 ^a	0.6	-	1.4	-	-	-	-	V
			5 ^a	1	-	-	-	1.6	-	-	
			10 ^a	2	-	-	-	-	-	1.6	
* V _{CE(sat)}			3 ^a	0.6	-	2	-	-	-	-	V
			5 ^a	1	-	-	-	2.5	-	-	
			10 ^a	2	-	-	-	-	-	2.5	
* t _s ^f		-5	3	0.6	-	4	-	-	-	-	μs
		-5	5	1	-	-	-	4	-	-	
		-5	10	2	-	-	-	-	-	5	
* t _f ^f		-5	3	0.6	-	0.8	-	-	-	-	μs
		-5	5	1	-	-	-	0.9	-	-	
		-5	10	2	-	-	-	-	-	1.5	
* R _{θJC}					-	1.75	-	1.4	-	1	°C/W

- * In accordance with JEDEC registration data.
- † Pulsed: pulse duration = 300 μs, duty factor ≤ 2%.
- b CAUTION:** The sustaining voltage V_{CEO(sus)} and V_{CEX(sus)} **MUST NOT** be measured on a curve tracer.

- c V_{CC} = 20 V, L = 180 μH, R_C = 0.05 Ω
- d V_{CB} value
- e Resistive load, V_{CC} = 250 V, t_p = 100 μs,
I_{B1} = -I_{B2}
- f Inductive load, V_{clamp} = Rated V_{CEX(sus)},
I_{B1} = -I_C/5, L = 180 μH, R_C = 0.05 Ω, V_{CC} = 20 V

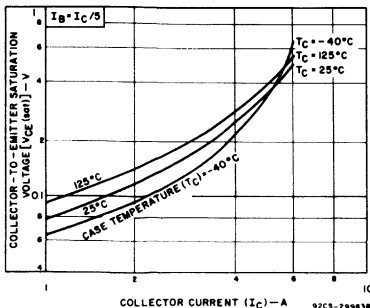


Fig. 11 - Typical collector-to-emitter saturation voltage as a function of collector current for types 2N6542 and 2N6544.

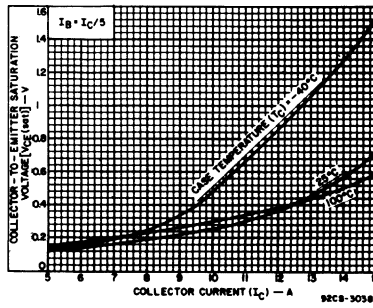


Fig. 12 - Typical collector-to-emitter saturation voltage characteristics for type 2N6546.

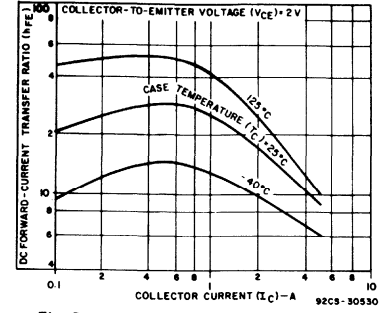


Fig. 8 - Typical dc beta characteristics for type 2N6542.

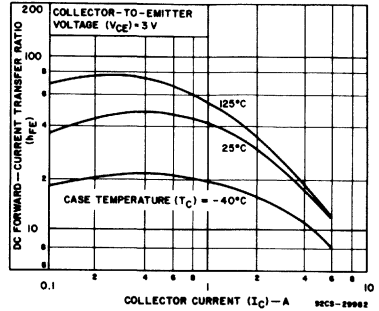


Fig. 9 - Typical dc beta characteristics for type 2N6544.

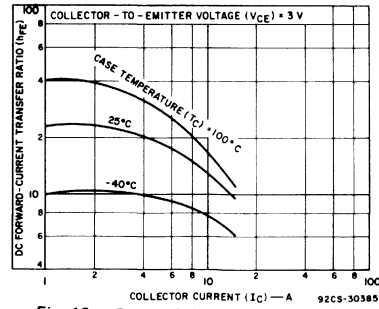


Fig. 10 - Typical dc beta characteristics for type 2N6546.

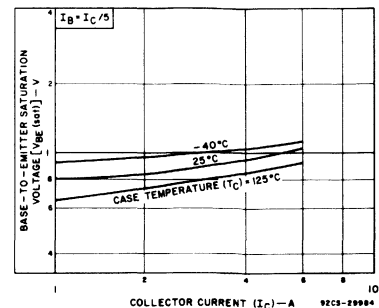


Fig. 13 - Typical base-to-emitter saturation voltage as a function of collector current for types 2N6542 and 2N6544.

2N6542, 2N6544, 2N6546

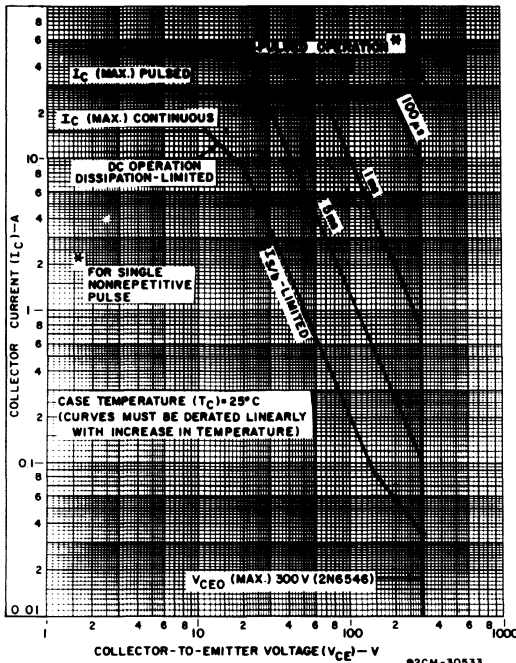


Fig. 14 - Maximum operating areas for type 2N6546 ($T_C = 25^\circ\text{C}$).

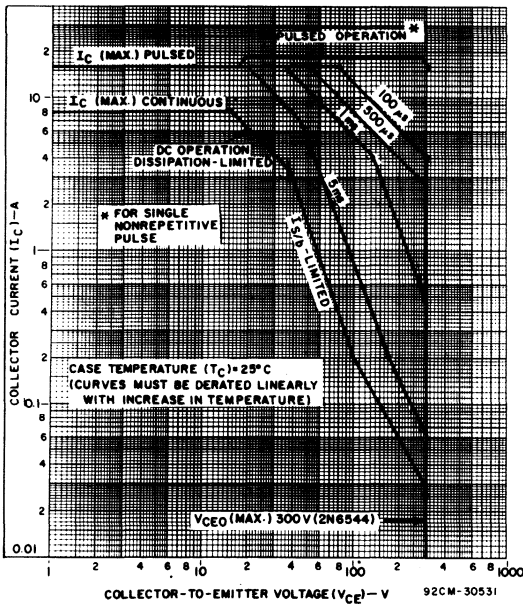


Fig. 15 - Maximum operating areas for type 2N6544 ($T_C = 25^\circ\text{C}$).

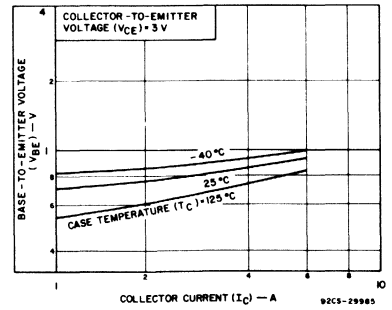


Fig. 16 - Typical base-to-emitter voltage as a function of collector current for types 2N6542 and 2N6544.

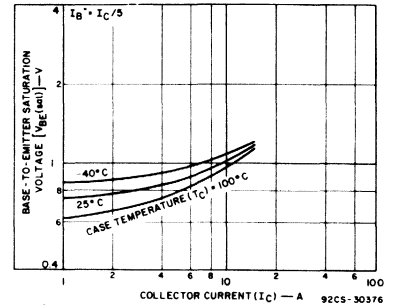


Fig. 17 - Typical base-to-emitter saturation voltage characteristics for type 2N6546.

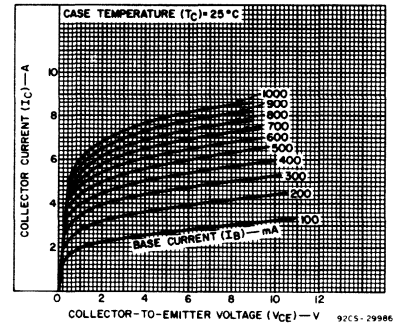


Fig. 18 - Typical output characteristics for types 2N6542 and 2N6544.

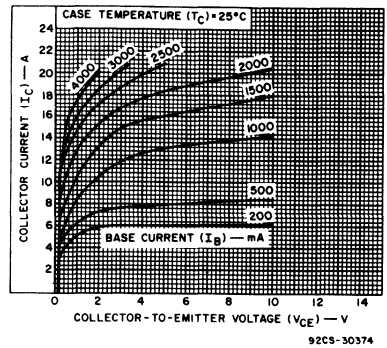


Fig. 19 - Typical output characteristics for type 2N6546.

2N6609, MJ15004, RCA9116C, RCA9116D, RCA9116E

Silicon P-N-P Epitaxial-Base High-Power Transistors

Rugged Devices, Broadly Applicable
For Industrial and Commercial Use

The RCA-2N6609, MJ15004, RCA9116C, RCA9116D, and RCA9116E are ballasted epitaxial-base silicon p-n-p transistors featuring high gain at high current. They may be used as complements to the n-p-n types RCA3773, MJ15003, RCA8638C, RCA8638D, and RCA8638E, respectively.

They differ in voltage ratings and in the currents at which the parameters are controlled. All are supplied in the steel JEDEC TO-204MA packages.

Features:

- High-dissipation capability
- Low saturation voltages
- Maximum safe-area-of-operation curves
- $f_T = 2$ MHz
- High gain at high current

Applications:

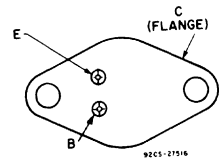
- Series and shunt regulators
- High-fidelity amplifiers
- Power-switching circuits
- Solenoid drivers

MAXIMUM RATINGS, Absolute-Maximum Values:

	2N6609	MJ15004	RCA9116C	RCA9116D	RCA9116E	
* V_{CBO}	-160	-140	-140	-120	-100	V
$V_{CEX}^{(sus)}$						
$V_{BE} = -1.5$ V; $R_{BE} = 100 \Omega$	-160	-	-	-	-	V
$V_{CER}^{(sus)}$						
$R_{BE} = 100 \Omega$	-150	-150	-150	-130	-110	V
* $V_{CEO}^{(sus)}$	-140	-140	-140	-120	-100	V
* V_{EBO}	-7	-	-5	-	-	V
* I_C	-16	-	-20	-	-	A
* I_B	-4	-	-5	-	-	A
* P_T						
At $T_C \geq 25^\circ C$	150	250	200	200	200	W
At $T_C > 25^\circ C$	Derate linearly					$W/^\circ C$
* T_{stg}, T_J	-65	-65	-65	-65	-65	$^\circ C$
* T_L						
At distance $\geq 1/32$ in. (0.8 mm) from seating plane for 10 s max.	265	-	230	-	-	$^\circ C$

* 2N-type in accordance with JEDEC registration data format JS25RDF1, Issue 1.

TERMINAL DESIGNATIONS



JEDEC TO-204MA

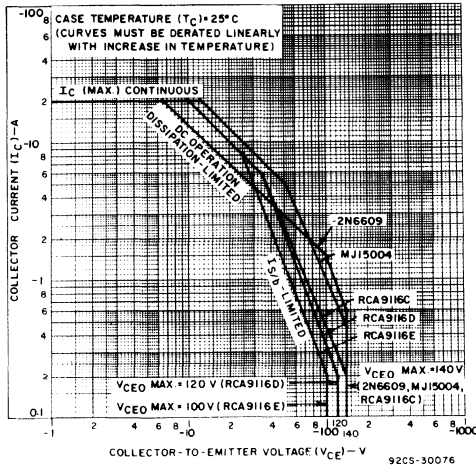


Fig. 1 - Maximum operating areas for all types.

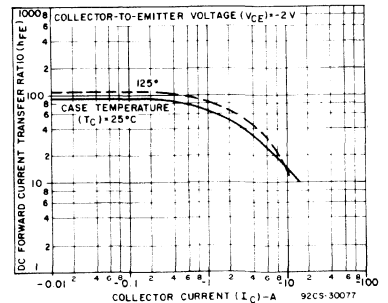


Fig. 2 - Typical dc beta characteristics as a function of collector current for all types.

2N6609, MJ15004, RCA9116C, RCA9116D, RCA9116E

ELECTRICAL CHARACTERISTICS, at Case Temperature (T_C) = 25°C Unless Otherwise Specified

CHARACTERISTIC	TEST CONDITIONS			LIMITS				UNITS	
	VOLTAGE V dc		CURRENT A dc	2N6609		MJ15004			
	V_{CE}	V_{BE}		Min.	Max.	Min.	Max.		
I_{CBO}	-160 ^a -140 ^a			-	-4	-	-		
I_{CEX}	-140	1.5		-	-	-	-0.1	mA	
I_{CEX} $T_C = 150^\circ\text{C}$	-140	1.5		-	-	-	-2		
I_{CEV}	-140	1.5		-	-2	-	-		
I_{CEV} $T_C = 150^\circ\text{C}$	-140	1.5		-	-10	-	-		
I_{CEO} $I_B = 0$	-140 -120			-	-	-	-0.25		
I_{EBO}	-7 -5			-	-5	-	-0.1		
h_{FE}	-4 -4 -2 -2		-8 ^c -16 ^c -5 ^c -10 ^c	15 5	60	- -	- -		
$V_{CEX(sus)}^b$ $R_{BE} = 100\Omega$		1.5	-0.2	-160	-	-	-		
$V_{CER(sus)}^b$ $R_{BE} \leq 100\Omega$			-0.2	-150	-	-150	-		
$V_{CEO(sus)}^b$			-0.2	-140	-	-140	-		
V_{EBO} $I_E = -1\text{ mA}$			0	-7	-	-5 ^d	-		
V_{BE}	-4 -2		-8 ^c -5 ^c	-	-2.2	-	-	V	
$V_{CE(sat)}$ $I_B = -3.2\text{ A}$ $= -0.8\text{ A}$ $= -0.5\text{ A}$			-16 ^c -8 ^c -5 ^c	-	-4 -1.4	-	-		
$I_{S/b}$ $t_p = 1\text{ s}$ nonrep.	-100 ⁱ -50			-1.5	-	-1	-		
$ h_{fe} $ $f = 0.05$ $= 0.5\text{ MHz}$	-4 -10		-1 -0.5	4 4	-	-	4	MHz	
f_T				2	-	2	-		
h_{fe} $f = 1\text{ kHz}$	-4		-1	40	-	-	-	pF	
C_{ob} $f = 0.1\text{ MHz}$	-10 ^a			-	1000	-	1000		
$R_{\theta JC}$	-10		-10	-	1.17	-	0.7	°C/W	

See page 252 for footnotes.

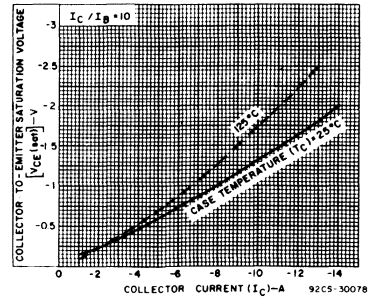


Fig. 3 — Typical saturation voltage characteristics for all types.

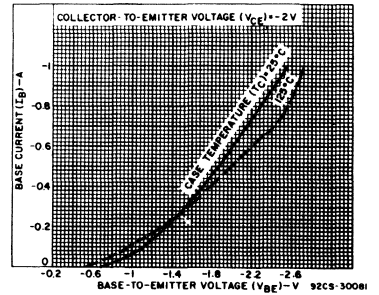


Fig. 4 — Typical input characteristics for all types.

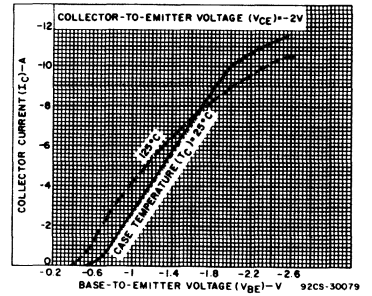


Fig. 5 — Typical transfer characteristics for all types.

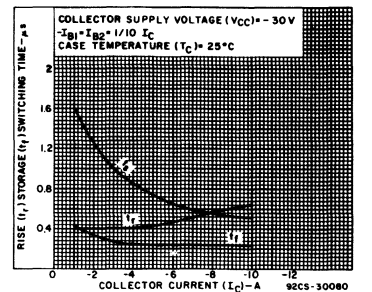


Fig. 6 — Typical saturated-switching times for all types.

2N6609, MJ15004, RCA9116C, RCA9116D, RCA9116E

ELECTRICAL CHARACTERISTICS, at Case Temperature (T_C) = 25°C
 Unless Otherwise Specified (Cont'd)

CHARACTERISTIC	TEST CONDITIONS			LIMITS						UNITS	
	VOLTAGE V dc		CUR- RENT A dc	RCA9116C		RCA9116D		RCA9116E			
	V _{CE}	V _{BE}	I _C	Min.	Max.	Min.	Max.	Min.	Max.		
I _{CBO}	-140 ^a -120 ^a -100 ^a			-	-1	-	-	-	-	-	mA
I _{CEX}	-140 -120	1.5 1.5		-	-1	-	-	-	-	-	
I _{CEX} T _C = 150°C	-140 -120	1.5 1.5		-	-5	-	-	-	-	-	
I _{CEO} I _B = 0	-70 -60			-	-1	-	-	-	-	-	
I _{EBO}	-5			-	-1	-	-1	-	-1	-	
h _{FE}	-2 -2 2		-5 ^c -7.5 ^c -10 ^c	25 -	150 -	25 -	150 -	- 10 -	- 100 -	-	V
V _{CER(sus)} ^b R _{BE} ≤ 100Ω			-0.2	-150	-	-130	-	-110	-	-	
V _{CEO(sus)} ^b			-0.2	-140	-	-120	-	-100	-	-	
V _{EBO} I _E = -1 mA			0	-5	-	-5	-	-5	-	-	
V _{BE}	-2 -2		-7.5 ^c -5 ^c	- -	- -2	- -	- -2	- -	- -	-3 -	
V _{CE(sat)} I _B = -0.75A = -0.5A			-7.5 ^c -5 ^c	- -	- -1	- -	- -1	- -	-1.5 -	-	
I _{S/b} t _p = 1 s nonrep.	-35 -25			-5.71 -	- -	-5.71 -	- -	- -8	- -	-	A
h _{fe} f = 0.5 MHz	-10		-0.5	4	-	4	-	4	-	-	MHz
f _T				2	-	2	-	2	-	-	
C _{ob} f = 0.1 MHz	-10 ^a			-	1000	-	1000	-	1000	-	pF
R _{θJC}	-10		-10	-	0.875	-	0.875	-	0.875	-	°C/W

* 2N-types in accordance with JEDEC registration data format JS25 RDF1, Issue 1.

^a V_{CB} ^b CAUTION: Sustaining voltages V_{CEX(sus)}, V_{CER(sus)}, and V_{CEO(sus)} MUST NOT be measured on a curve tracer.

^c Pulsed; pulse duration = 300 μs, duty factor = 1.8%.

^d Measured at I_E = -0.1 mA.

2N6648, 2N6649, 2N6650, RCA8350, RCA8350A, RCA8350B

10-Ampere P-N-P Darlington Power Transistors

40-60-80 Volts, 70 Watts
Gain of 1000 at 5 A

The 2N6648, 2N6649, 2N6650, and RCA8350, RCA8350A, RCA8350B, are monolithic silicon p-n-p Darlington transistors designed for low- and medium-frequency power applications. The high gain of these devices makes it possible for them to be driven directly from integrated circuits. The 2N6648 and RCA8350 are complementary to the 2N6383; the 2N6649 and the RCA8350A are complementary to the 2N6384; and the 2N6650 and RCA8350B are complementary to the 2N6385.

They are all supplied in hermetic steel JEDEC TO-204MA packages.

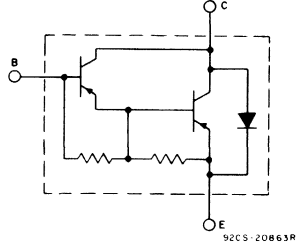


Fig. 1 — Schematic diagram for all types.

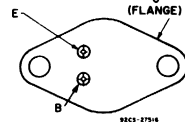
Features:

- Operates from IC without predriver
- High reverse second-breakdown capability

Applications:

- Power switching
- Audio amplifiers
- Hammer drivers
- Series and shunt regulators

TERMINAL DESIGNATIONS



JEDEC TO-204MA

• Formerly RCA Dev. Nos. TA8351, TA8488, and TA8350, respectively.

MAXIMUM RATINGS, Absolute-Maximum Values:

	2N6648 RCA8350	2N6649 RCA8350A	2N6650 RCA8350B	
* V_{CBO}	-40	-60	-80	V
$V_{CER(sus)}$ $R_{BE} = 100 \Omega$	-40	-60	-80	V
* $V_{CEO(sus)}$	-40	-60	-80	V
$V_{CEV(sus)}$ $V_{BE} = -1.5 V$	-40	-60	-80	V
* V_{EBO}	-5	-5	-5	V
* I_C	-10	-10	-10	A
* I_{CM}	-15	-15	-15	A
* I_B	-0.25	-0.25	-0.25	A
* P_T $T_C \leq 25^\circ C$	70	70	70	W
$T_C > 25^\circ C$	Derate linearly			W/°C
* T_{stg}, T_J	-65 to +150			°C
* T_L At distances $\geq 1/32$ in. (0.8 mm) from seating plane for 10 s max.	235			°C

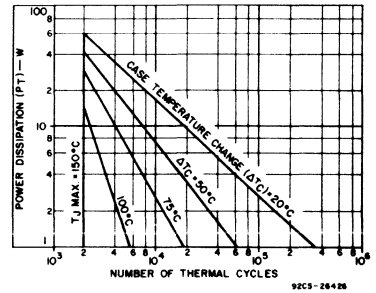


Fig. 2 — Thermal-cycling rating chart for all types.

* In accordance with JEDEC registration data format (JS-6 RDF-4)

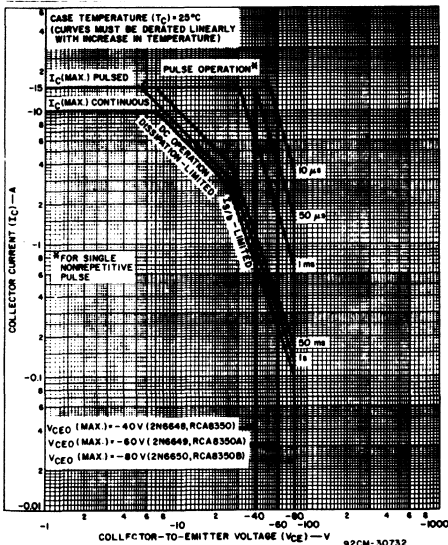


Fig. 3 — Maximum operating areas for all types.

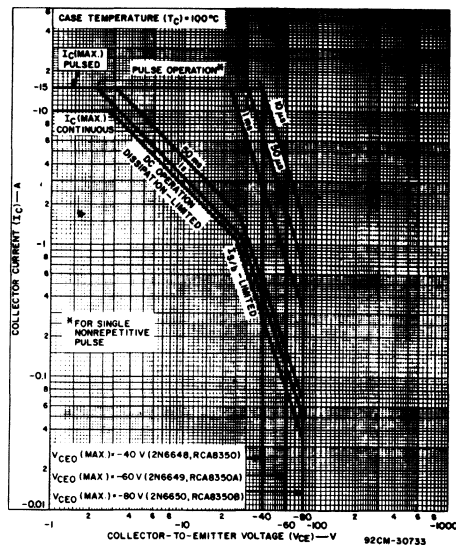


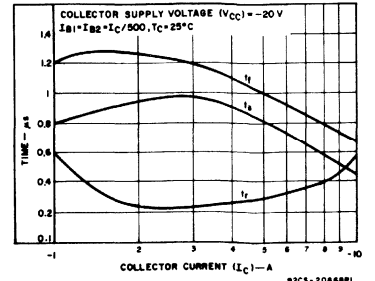
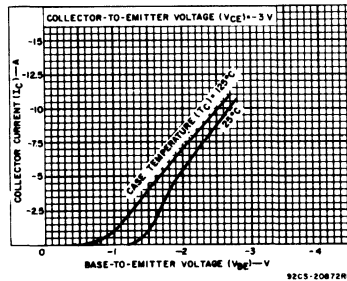
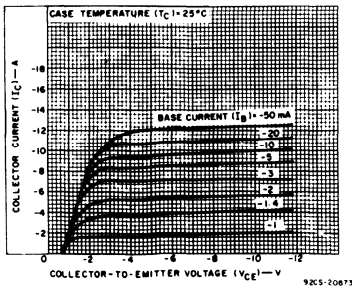
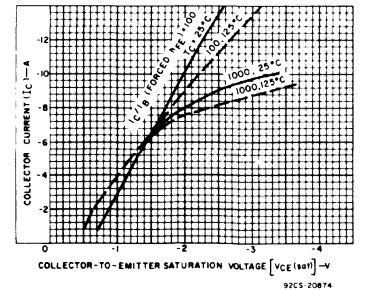
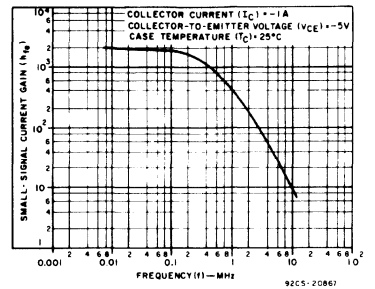
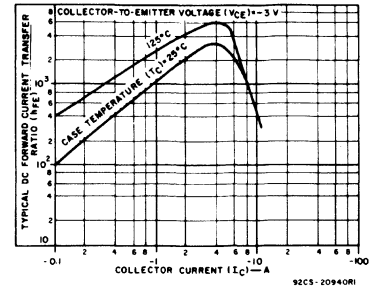
Fig. 4 — Maximum operating areas for all types at $T_C = 100^\circ C$.

2N6648, 2N6649, 2N6650, RCA8350, RCA8350A, RCA8350B

ELECTRICAL CHARACTERISTICS, At Case Temperature (T_C) = 25°C Unless Otherwise Specified

CHARACTERISTIC	TEST CONDITIONS				LIMITS						UNITS	
	VOLTAGE V dc		CURRENT A dc		2N6648 RCA8350		2N6649 RCA8350A		2N6650 RCA8350B			
	V _{CE}	V _{BE}	I _C	I _B	MIN.	MAX.	MIN.	MAX.	MIN.	MAX.		
I _{CEO}	-40 -60 -80			0 0 0	-	-1	-	-	-	-	-	mA
* I _{CEV}	-40 -60 -80	1.5 1.5 1.5			-	-0.3	-	-	-	-	-	
T _C = 150°C	-40 -60 -80	1.5 1.5 1.5			-	-3	-	-	-	-	-3	
* I _{EBO}		5	0		-	-10	-	-10	-	-10		mA
* V _{CEO(sus)}			-0.2 ^a	0	-40	-	-60	-	-80	-		V
V _{CER(sus)} R _{BE} = 100 Ω			-0.2 ^a		-40	-	-60	-	-80	-		V
V _{CEV(sus)}		1.5	-0.2 ^a		-40	-	-60	-	-80	-		V
* h _{FE}	-3 -3		-5 ^a -10 ^a		1000 100	20,000	1000	20,000	1000	20,000		
V _{BE}	-3 -3		-5 ^a -10 ^a		-	-2.8 -4.5*	-	-2.8 -4.5*	-	-2.8 -4.5*		V
V _{CE(sat)}			-5 ^a -10 ^a	-0.01 ^a -0.1 ^a	-	-2 -3*	-	-2 -3*	-	-2 -3*		V
V _F			10 ^a		-	4	-	4	-	4		V
h _{fe} f = 1 kHz	-5		-1		1000	-	1000	-	1000	-		
* h _{fe} f = 1 MHz	-5		-1		20	-	20	-	20	-		
ES/b L = 3 mH, R _{BE} = 100 Ω		1.5	-4.5		30	-	30	-	30	-		mJ
IS/b t = 1 s, nonrep.	-35 -25				-1 -2.8	-	-1 -2.8	-	-1 -2.8	-		A
R _{θJC}					-	1.75	-	1.75	-	1.75		°C/W

* In accordance with JEDEC registration data format (JS-6 RFD-4).
^a Pulsed: Pulse duration = 300 μs, duty factor = 1.8%.



2N6666, 2N6667, 2N6668, RCA8203, RCA8203A, RCA8203B

10-Ampere P-N-P Darlington Power Transistors

40-60-80 Volts, 65 Watts

Gain of 1000 at 3 A (2N6666, RCA8203)

Gain of 1000 at 5 A (2N6667, 2N6668, RCA8203A, RCA8203B)

The 2N6666, 2N6667, 2N6668, and RCA8203, RCA8203A, RCA8203B are monolithic silicon p-n-p Darlington transistors designed for low- and medium-frequency power applications. The high gain of these devices makes it possible for them to be driven directly from integrated circuits. The 2N6666 and RCA8203 are complementary to the 2N6386; the 2N6667 and RCA8203A are complementary to the 2N6387; and the 2N6668 and RCA8203B are complementary to the 2N6388.▲

These devices are supplied in the JEDEC TO-220AB straight-lead version of the VERSA-WATT package

Optional lead configurations are available upon request. For information, contact your nearest RCA Sales Office.

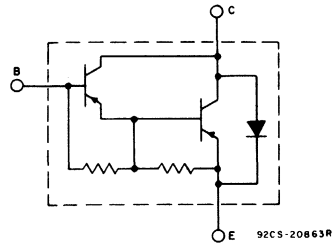


Fig. 1 — Schematic diagram for all types.

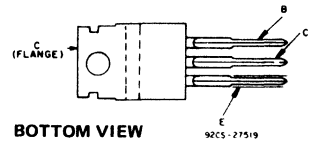
Features:

- Operates from IC without predriver
- High reverse second-breakdown capability

Applications:

- Power switching
- Audio amplifiers
- Hammer drivers
- Series and shunt regulators

TERMINAL DESIGNATIONS



BOTTOM VIEW

JEDEC TO-220AB

▲ Formerly RCA Dev. Nos. TA8204, TA8487 and TA8203, respectively.

▲ Technical data for 2N6386-2N6388 are given in RCA Bulletin File No. 610.

MAXIMUM RATINGS, Absolute-Maximum Values:

	2N6666 RCA8203	2N6667 RCA8203A	2N6668 RCA8203B	
V_{CBO}	-40	-60	-80	V
V_{CER} (sus)	-40	-60	-80	V
$R_{BE} = 100 \Omega$	-40	-60	-80	V
V_{CEO} (sus)	-40	-60	-80	V
V_{CEV} (sus)	-40	-60	-80	V
$V_{BE} = -1.5 V$	-40	-60	-80	V
V_{EBO}	-5	-5	-5	V
I_C	-8	-10	-10	A
I_{CM}	-15	-15	-15	A
I_B	-0.25	-0.25	-0.25	A
P_T	65	65	65	W
$T_C \leq 25^\circ C$	65	65	65	W
$T_C > 25^\circ C$	derate linearly			$W/^\circ C$
T_{stg}, T_J	-65 to +150			$^\circ C$
T_L	235			$^\circ C$

At distances $\geq 1/8$ in. (3.17 mm) from case for 10 s max.

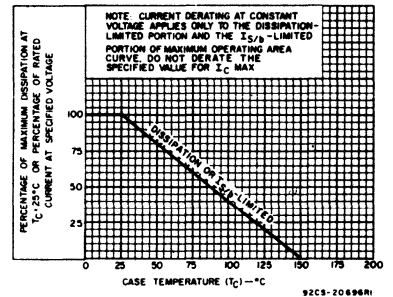


Fig. 2 — Derating curve for all types.

*In accordance with JEDEC registration data format (JS-6 RDF-4).

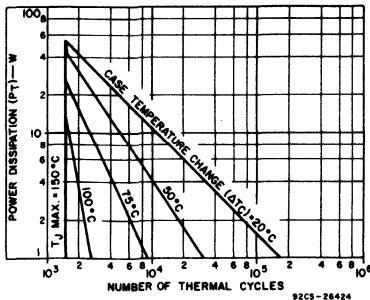


Fig. 3 — Thermal-cycling rating chart for all types.

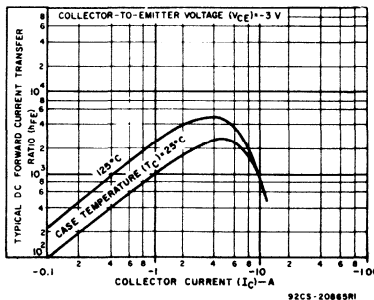


Fig. 4 — Typical dc beta characteristics for all types.

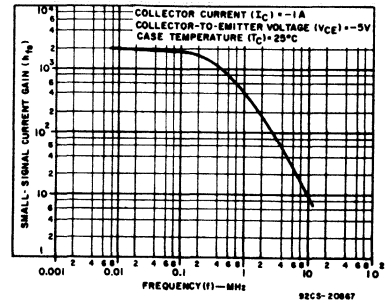


Fig. 5 — Typical small-signal gain for all types.

2N6666, 2N6667, 2N6668, RCA8203, RCA8203A, RCA8203B

ELECTRICAL CHARACTERISTICS, At Case Temperature (T_C) = 25°C Unless Otherwise Specified

CHARACTERISTIC SYMBOL	TEST CONDITIONS				LIMITS						UNITS
	VOLTAGE V dc		CURRENT A dc		2N6666 RCA8203		2N6667 RCA8203A		2N6668 RCA8203B		
	V _{CE}	V _{BE}	I _C	I _B	MIN.	MAX.	MIN.	MAX.	MIN.	MAX.	
I _{CEO}	-80 -60 -40			0 0 0	- - -	- - -1	- - -	- -1 -	- - -	-1 - -	mA
* I _{CEV}	-80 -60 -40	1.5 1.5 1.5			- - -	- -0.3 -	- - -	-0.3 - -	- - -	-0.3 - -	
$T_C = 125^\circ\text{C}$	-80 -60 -40	1.5 1.5 1.5			- - -	- -3 -	- - -	-3 - -	- - -	-3 - -	
I _{EBO}		5	0		-	-10	-	-10	-	-10	mA
* V _{CE(sus)}			-0.2 ^a	0	-40	-	-60	-	-80	-	V
V _{CE(sus)} R _{BE} = 100 Ω			-0.2 ^a		-40	-	-60	-	-80	-	
V _{CEV(sus)}		1.5	-0.2 ^a		-40	-	-60	-	-80	-	
* h _{FE}	-3 -3 -3 -3		-3 ^a -5 ^a -8 ^a -10 ^a		1000 - 100 -	20,000 - - -	- - 100 -	1000 20,000 - -	1000 - 100 -	20,000 - - -	
V _{BE}	-3 -3 -3 -3		-3 ^a -5 ^a -8 ^a -10 ^a		- - - -	2.8 - 4.5 -	- - - -	- -2.8 - -4.5	- - - -	-2.8 - - -4.5	V
* V _{CE(sat)}			-3 ^a -5 ^a -8 ^a -10 ^a	-0.006 ^a -0.01 ^a -0.08 ^a -0.1 ^a	- - - -	-2 - -3 -	- - - -	- -2 - -3	- - - -	- -2 - -3	V
V _F			8 ^a 10 ^a		- -	4 -	- -	4 -	- -	4 -	V
h _{fe} f = 1 kHz	-5		-1		1000		1000		1000		
* h _{fe} f = 1 MHz	-5		-1		20		20		20		
E _{s/b} L = 3 mH, R _{BE} = 100 Ω		1.5	4.5		30		30		30		mJ
I _{S/b} t = 1 s, nonrep.	-20				3.2		-3.2		-3.2		A
R _{θJC}					-	1.92	-	1.92	-	1.92	°C/W

^aPulsed: Pulse duration = 300 μs, duty factor = 2%.
 * In accordance with JEDEC registration data format (JS-6 RDF-4).

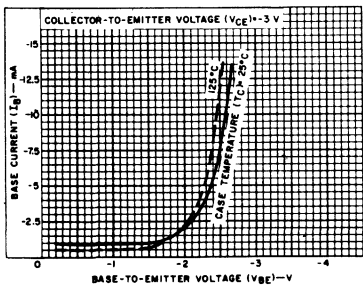


Fig. 6 - Typical input characteristics for all types.

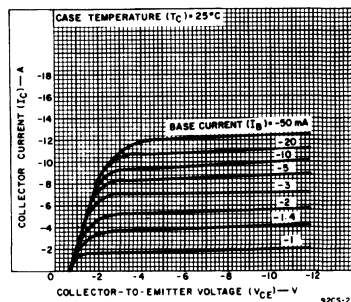


Fig. 7 - Typical output characteristics for all types.

2N6666, 2N6667, 2N6668, RCA8203, RCA8203A, RCA8203B

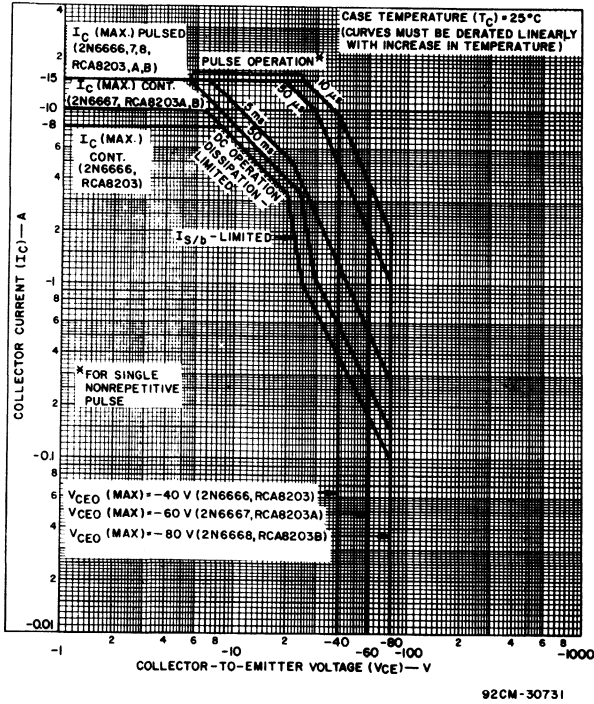


Fig. 8 — Maximum operating areas for all types of $T_C = 25^\circ C$.

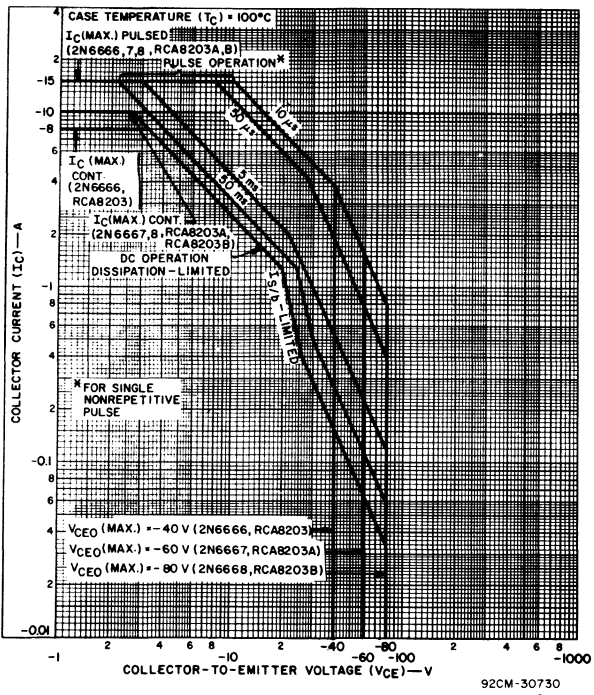


Fig. 11 — Maximum operating areas for all types at $T_C = 100^\circ C$.

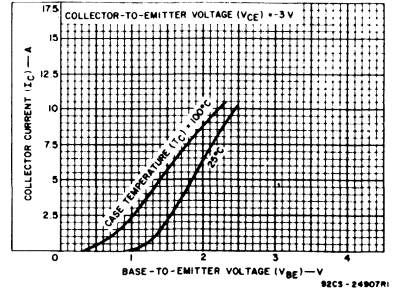


Fig. 9 — Typical transfer characteristics for all types.

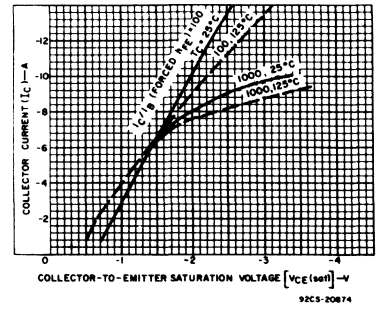


Fig. 10 — Typical saturation characteristics for all types.

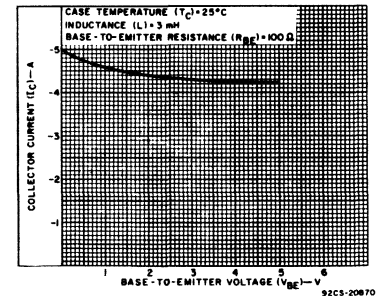


Fig. 12 — Minimum values of reverse-bias second breakdown characteristic (E_{SB}) for all types.

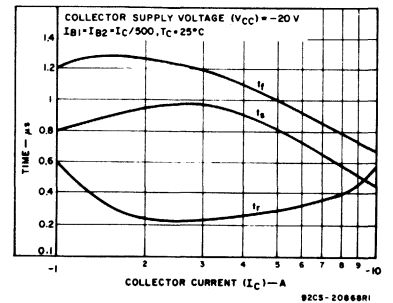


Fig. 13 — Typical saturated switching-time characteristics for all types.

2N6669

Epitaxial-Base, Silicon N-P-N VERSAWATT Transistor

Features:

- Low saturation voltages
- Switching speed

General-Purpose, Medium-Power Type for Switching and Amplifier Applications

The RCA-2N6669[●] is an epitaxial-base silicon n-p-n transistor supplied in the VERSAWATT package. This transistor is intended for a wide variety of medium-power switching and amplifier applications such as series and

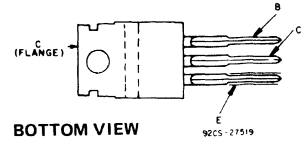
shunt regulators, automotive voltage regulators, and driver stages for high-fidelity amplifiers.

[●] Formerly RCA Dev. No. TA9105.

MAXIMUM RATINGS, Absolute-Maximum Values:		2N6669	
* V_{CBO}	40	V
* V_{CEO}	30	V
* V_{EBO}	5	V
* I_C	10	A
* I_B	4	A
* I_E	14	A
* P_T :			
At $T_C = 25^\circ\text{C}$	40	W
At $T_C = 100^\circ\text{C}$	16	W
At $T_C \geq 25^\circ\text{C}$ Derate linearly	0.32	W/ $^\circ\text{C}$
* T_{stg}, T_J	-65 to 150	$^\circ\text{C}$
* T_L (During soldering):			
At distance 0.125 in. (3.17 mm) from case for 10 s max.	235	$^\circ\text{C}$

* In accordance with JEDEC registration data format (JC-25 RDF-1).

TERMINAL DESIGNATIONS



JEDEC TO-220AB

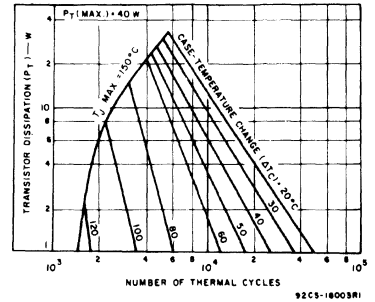


Fig. 1 - Thermal-cycling rating chart.

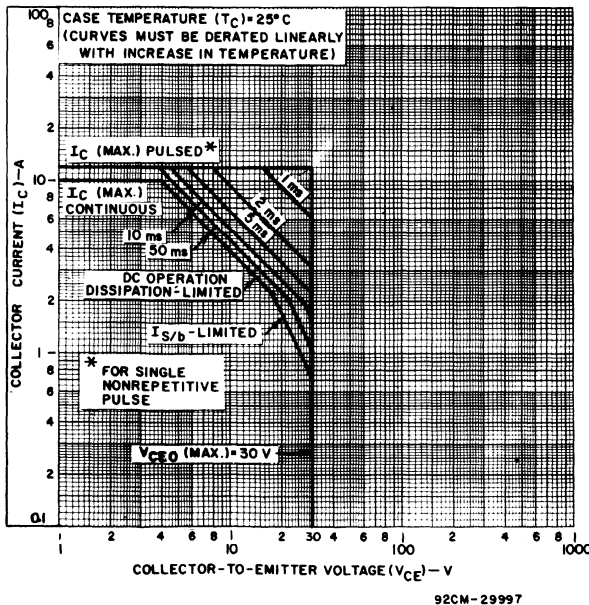


Fig. 2 - Maximum operating areas at $T_C = 25^\circ\text{C}$.

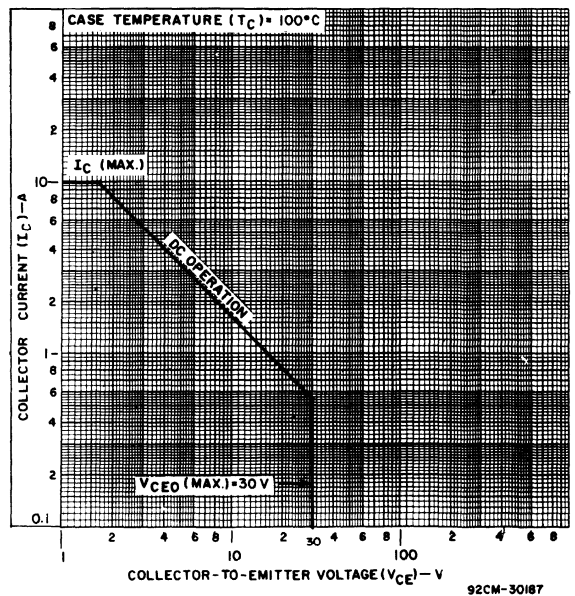


Fig. 3 - Maximum operating areas at $T_C = 100^\circ\text{C}$.

2N6669

ELECTRICAL CHARACTERISTICS, Case Temperature (T_C) = 25°C
Unless Otherwise Specified

CHARACTERISTIC	TEST CONDITIONS				LIMITS			UNITS
	VOLTAGE V dc		CURRENT A dc		2N6669			
	V_{CE}	V_{BE}	I_C	I_B	Min.	Typ.	Max.	
I_{CEO}	20				—	—	0.1	mA
* I_{CEV} $T_C = 100^\circ\text{C}$	40	-1.5			—	—	0.1	mA
* I_{EBO}		5.0			—	—	1.0	mA
* V_{CEO} (sus)			0.2		30	—	—	V
V_{CER} (sus) $R_{BE} = 50 \Omega$			0.2		40	—	—	V
* h_{FE}	2		5 ^a		20	—	100	
* V_{BE} (sat)			5 ^a	0.5	—	—	2.0	V
* V_{CE} (sat)			5 ^a 10 ^a	0.5 1.0	—	—	1.0 2.5	V
* C_{obo} $V_{CB} = 10 \text{ V}, f = 1 \text{ MHz}$					50	—	150	pF
* $ h_{fe} $ $f = 1 \text{ MHz}$	2		0.5		10	—	70	
$I_{S/b}$ $t = 0.5 \text{ s}, \text{nonrepetitive}$	25 10				1.0 4.0	—	—	A
* t_d^c			5.0	0.5	—	0.03	0.05	μs
* t_r^c			5.0	0.5	—	0.2	0.3	
* t_s^c			5.0	0.5	—	0.3	0.5	
* t_f^c			5.0	0.5	—	0.3	0.5	
* $R_{\theta JC}$	10		4		—	—	3.125	

*Minimum and maximum values and test conditions in accordance with JEDEC registration data format JC-25 RDF-1.
^aPulsed; pulse duration = 300 μs , duty factor $\leq 2\%$.

^bCAUTION: The sustaining voltages V_{CEO} (sus) and V_{CER} (sus) MUST NOT be measured on a curve tracer.

^c $V_{CC} = 30\text{V}, I_{B1} = -I_{B2}$

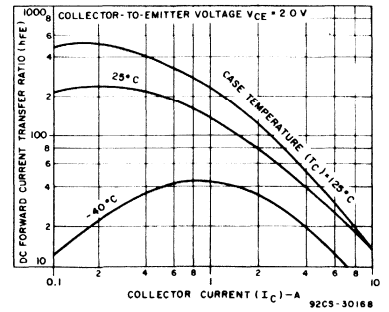


Fig. 4 - Typical dc beta characteristics.

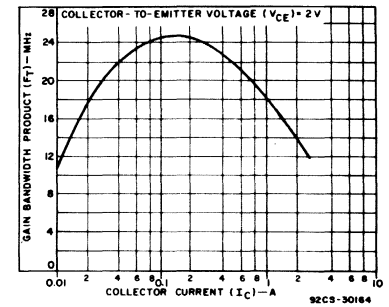


Fig. 5 - Typical gain-bandwidth product.

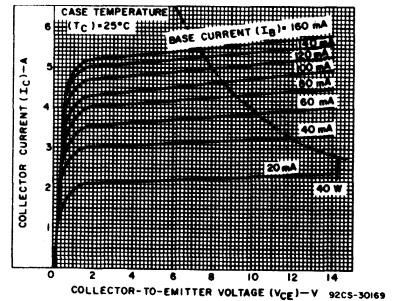


Fig. 6 - Typical output characteristics.

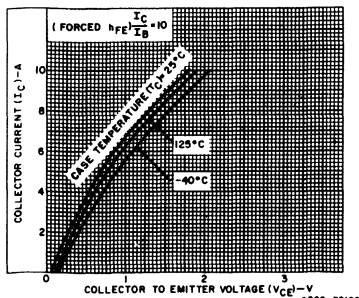


Fig. 7 - Typical saturation characteristics.

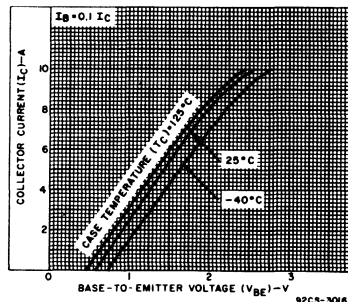


Fig. 8 - Typical base-to-emitter saturation characteristics.

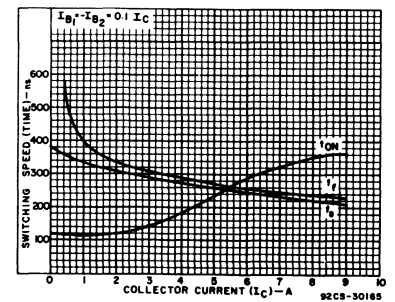


Fig. 9 - Typical saturated switching characteristics.

2N6671, 2N6672, 2N6673

5-A *SwitchMax* Power Transistors

High-Voltage N-P-N Types for Off-Line Power Supplies and Other High-Voltage Switching Applications

The RCA-2N6671, 2N6672, and 2N6673[•] SwitchMax series of silicon n-p-n power transistors feature high-voltage capability, fast switching speeds, and low saturation voltages, together with high safe-operating-area (SOA) ratings. They are specially designed for use in off-line power supplies and are also well suited for use in a wide range of inverter or converter circuits and pulse-width-modulated regulators. These high-voltage,

high-speed transistors are 100-per-cent tested for parameters that are essential to the design of industrial high-power switching circuits. Switching times, including inductive turn-off time, and saturation voltages are tested at 125°C, as well as at 25°C, to provide information necessary for worst-case design.

The RCA-2N6671, 2N6672, and 2N6673 series transistors are supplied in steel JEDEC TO-204MA hermetic packages.

Features:

- 100% High-Temperature Tested for 125°C Parameters
- Fast Switching Speed
- High Voltage Ratings:
V_{CEX} = 350 V to 450 V
- Low V_{CE(sat)} at I_C = 5 A
- Steel Hermetic TO-204MA Package

Applications:

- Off-Line Power Supplies
- High-Voltage Inverters
- Switching Regulators

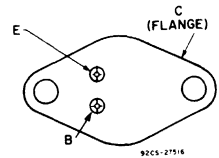
[•] Formerly RCA8767, RCA8767A, and RCA8767B, respectively.

MAXIMUM RATINGS, Absolute-Maximum Values:

	2N6671	2N6672	2N6673	
* V _{CEV} V _{BE} = -1.5 V	450	550	650	V
* V _{CEX} (Clamped) V _{BE} = -1.5 V	350	400	450	V
* V _{CEO}	300	350	400	V
* V _{EBO}	8	5	5	V
* I _{C(sat)}	5	8	10	A
* I _C	5	8	10	A
* I _{CM}	5	8	10	A
* I _B	4	4	4	A
* P _T				W
T _C up to 25°C	150			W
T _C above 25°C, derate linearly	0.86			W/°C
* T _{stg} , T _J	-65 to 200			°C
* T _L				°C
At distance ≥ 1/16 in. (1.58 mm) from seating plane for 10 s max.	235			°C

* In accordance with JEDEC registration data.

TERMINAL DESIGNATIONS



JEDEC TO-204MA

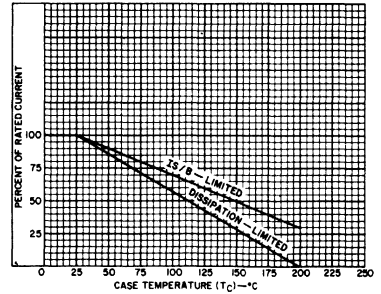


Fig. 1 - Dissipation and I_S/b derating curves for all types.

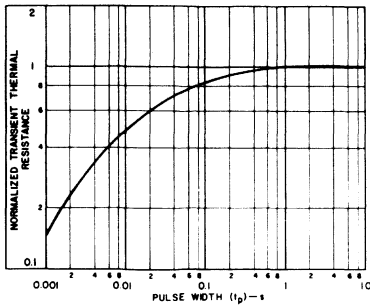


Fig. 2 - Typical thermal-response characteristic for all types.

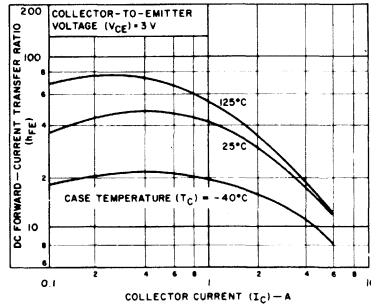


Fig. 3 - Typical dc beta characteristics for all types.

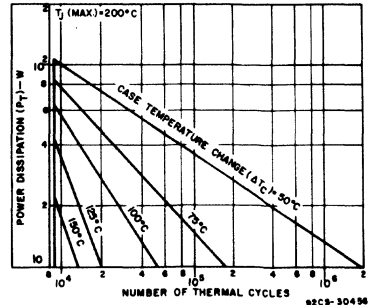


Fig. 4 - Thermal-cycling chart for all types.

2N6671, 2N6672, 2N6673

ELECTRICAL CHARACTERISTICS

CHARACTERISTIC	TEST CONDITIONS				LIMITS						UNITS
	VOLTAGE V _{dc}		CURRENT A _{dc}		2N6671		2N6672		2N6673		
	V _{CE}	V _{BE}	I _C	I _B	Min.	Max.	Min.	Max.	Min.	Max.	

T_C = 25°C

* I _{CEV}	450 550 650	-1.5 -1.5 -1.5			-	0.1	-	-	-	-	mA
* I _{EBO}		-8	0		-	2	-	2	-	2	
* V _{CEO(sus)} ^b			0.2 ^a	0	300	-	350	-	400	-	V
* h _{FE}	3		5 ^a		10	40	10	40	10	40	
* V _{BE(sat)}			5 ^a	1	-	1.6	-	1.6	-	1.6	
* V _{CE(sat)}			5 ^a 8 ^a	1 4	- 2	1	- 2	1	- 2	1	V
* V _{CEX} ^b (Clamped E _{S/b}) L=170 μH R _{BB} =5 Ω		-5 -5	5 8	1 ^e 3 ^e	350 200	-	400	-	450	-	
* I _{S/b}	25		6		1	-	1	-	1	-	s
* h _{fe} f=5 MHz	10		0.2		3	12	3	12	3	12	
* f _T	10		0.2		15	60	15	60	15	60	MHz
* C _{obo} f=0.1 MHz	10 ^c				50	300	50	300	50	300	pF
* t _d ^d			5	1	-	0.1	-	0.1	-	0.1	μs
* t _r ^d			5	1	-	0.5	-	0.5	-	0.5	
* t _s ^d			5	1 ^e	-	2.5	-	2.5	-	2.5	
* t _f ^d			5	1 ^e	-	0.4	-	0.4	-	0.4	
* t _c V _{CC} =125 V, L=170 μH, R _C =25 Ω Collector clamped to V _{CEX}			5	1 ^e	-	0.4	-	0.4	-	0.4	

T_C = 125°C

* I _{CEV}	450 550 650	-1.5 -1.5 -1.5			-	1	-	-	-	-	mA
* V _{CE(sat)}			5 ^a	1	-	2	-	2	-	2	V
* t _r ^d			5	1	-	0.8	-	0.8	-	0.8	μs
* t _s ^d			5	1 ^e	-	4	-	4	-	4	
* t _f ^d			5	1 ^e	-	0.8	-	0.8	-	0.8	
* t _c V _{CC} =125 V, L=170 μH, R _C =25 Ω Collector clamped to V _{CEX}			5	1 ^e	-	0.8	-	0.8	-	0.8	

* R _{θJC}					-	1.17	-	1.17	-	1.17	°C/W
--------------------	--	--	--	--	---	------	---	------	---	------	------

* In accordance with JEDEC registration data.

^a Pulsed: pulse duration = 300 μs, duty factor ≤ 2%.

^b CAUTION: The sustaining voltage V_{CEO(sus)}

and V_{CEX} MUST NOT be measured on a curve tracer.

^c V_{CB} value.

^e I_{B1} = -I_{B2}

^d V_{CC} = 125 V, t_p = 20 μs.

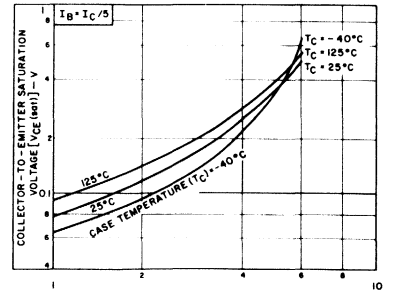


Fig. 5 - Typical collector-to-emitter saturation voltage as a function of collector current for all types.

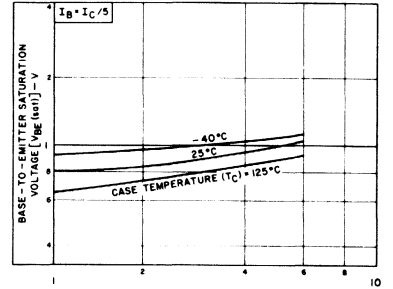


Fig. 6 - Typical base-to-emitter saturation voltage as a function of collector current for all types.

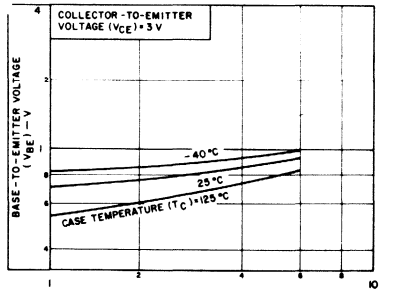


Fig. 7 - Typical base-to-emitter voltage as a function of collector current for all types.

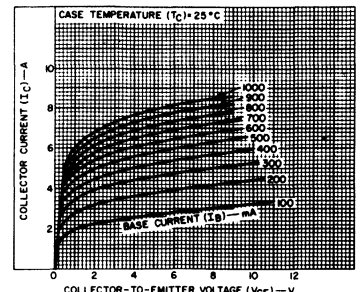


Fig. 8 - Typical output characteristics for all types.

2N6671, 2N6672, 2N6673

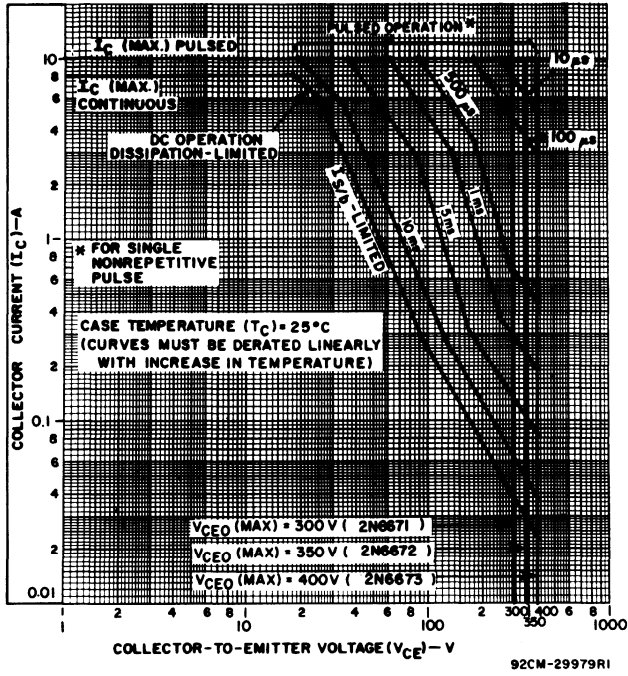


Fig. 9 - Maximum operating areas for all types ($T_C = 25^\circ C$).

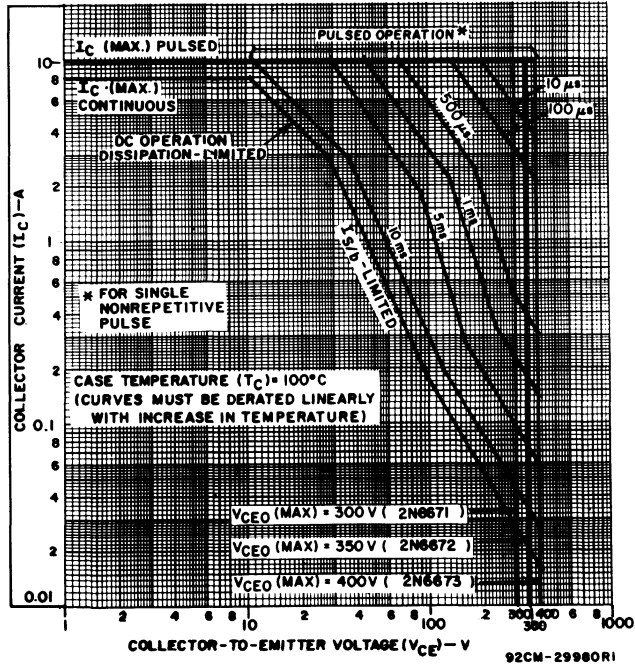


Fig. 10 - Maximum operating areas for all types ($T_C = 100^\circ C$).

2N6671, 2N6672, 2N6673

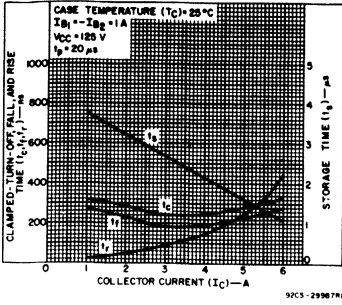


Fig. 11 — Typical saturated switching time characteristics for all types.

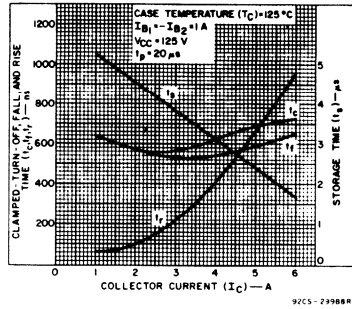


Fig. 12 — Typical saturated switching time characteristics for all types.

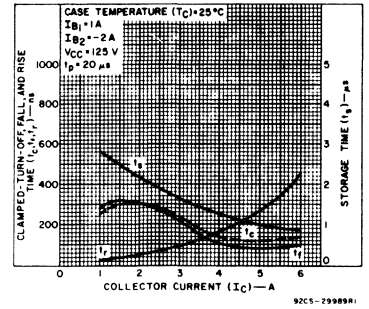


Fig. 13 — Typical saturated switching time characteristics for all types.

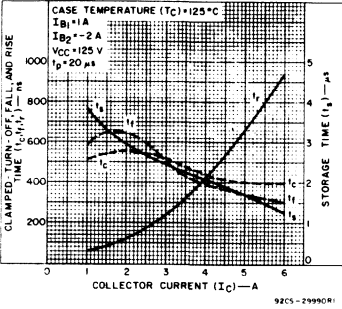


Fig. 14 — Typical saturated switching time characteristics for all types.

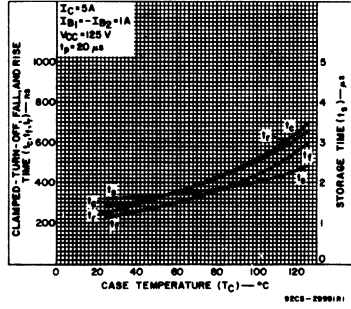


Fig. 15 — Typical saturated switching time characteristics as a function of case temperature for all types.

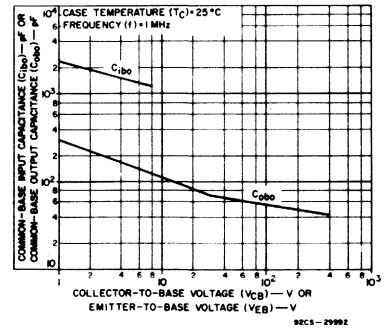


Fig. 16 — Typical common-base input or output capacitance characteristics as a function of collector-to-base voltage or emitter-to-base voltage for all types.

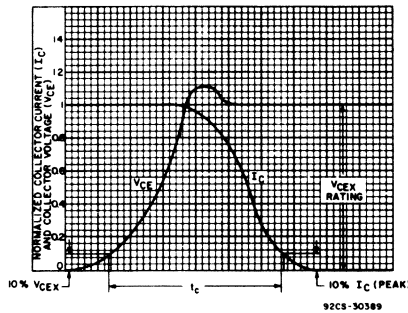


Fig. 17 — Oscilloscope display for measurement of clamped induction switching time (t_c).

2N6674, 2N6675

10-A *SwitchMax* Power Transistors

High-Voltage N-P-N Types for Off-Line Power Supplies and Other High-Voltage Switching Applications

The RCA-2N6674 and 2N6675[•] SwitchMax series of silicon n-p-n power transistors feature high-voltage capability, fast switching speeds, and low saturation voltages, together with high safe-operating-area (SOA) ratings. They are specially designed for off-line power supplies, converter circuits and pulse-width-modulated regulators. These high-voltage, high-speed transistors are 100-per-cent tested for parameters that are essential to the design of high-power switching circuits. Switching

times, including inductive turn-off time, and saturation voltages are tested at 100°C, as well as at 25°C, to provide information necessary for worst-case design.

The 2N6674 and 2N6675 transistors are supplied in steel JEDEC TO-204MA hermetic packages.

[•] Formerly RCA Dev. Type Nos. TA9114D and TA9114E, respectively.

Features:

- 100% High-Temperature Tested for
- Fast Switching Speed
- High Voltage Ratings:
V_{CEX} = 350 V to 450 V
- Low V_{CE}(sat) at I_C = 10 A
- Steel Hermetic TO-204MA Package
100°C Parameters

Applications:

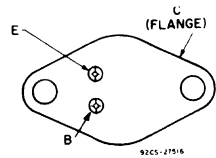
- Off-Line Power Supplies
- High-Voltage Inverters
- Switching Regulators

MAXIMUM RATINGS, Absolute-Maximum Values:

	2N6674	2N6675	
* V _{CEV} V _{BE} = -1.5 V	450	650	V
* V _{CEX} (Clamped) V _{BE} = -1.5 V	350	450	V
* V _{CEO}	300	400	V
* V _{EBO}	7	7	V
* I _C (sat)	10	10	A
* I _C	15	15	A
* I _{CM}	20	20	A
* I _B	5	5	A
* P _T T _C up to 25°C	175	175	W
T _C above 25°C, derate linearly	1	1	W/°C
* T _{stg} , T _J	-65 to 200	-65 to 200	°C
* T _L At distance ≥ 1/16 in. (1.58 mm) from seating plane for 10 s max.	235	235	°C

* In accordance with JEDEC registration data.

TERMINAL DESIGNATIONS



JEDEC TO-204MA

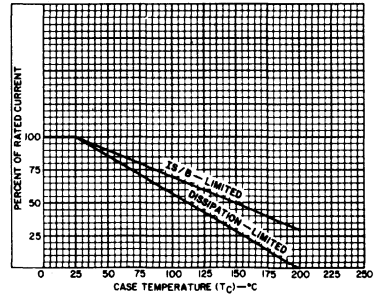


Fig. 2 - Dissipation and I_B/θ derating curves for both types.

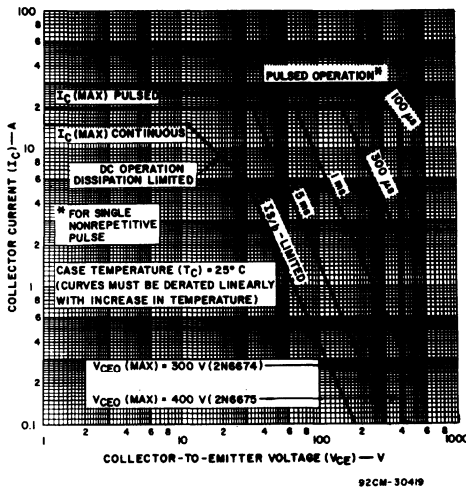


Fig. 1 - Maximum operating areas for both types (T_C = 25°C).

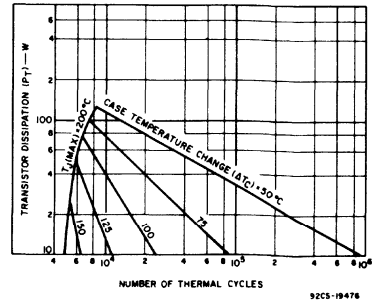


Fig. 3 - Thermal-cycling chart for both types.

2N6674, 2N6675

ELECTRICAL CHARACTERISTICS

CHARACTERISTIC	TEST CONDITIONS				LIMITS				UNITS
	VOLTAGE		CURRENT		2N6674		2N6675		
	V _{dc}		A _{dc}		Min.	Max.	Min.	Max.	

T_C = 25°C

I _{CEV}	450 650	-1.5 -1.5			-	0.1	-	-	mA
I _{EBO}		-7	0		-	2	-	2	
V _{CEO(sus)} ^b			0.2 ^a	0	300	-	400	-	V
h _{FE}	2		10 ^a		8	20	8	20	
V _{BE(sat)}			10 ^a	2	-	1.5	-	1.5	V
V _{CE(sat)}			10 ^a	2	-	1	-	1	
V _{CEX} ^b (Clamped E _{S/b}) L=50 μH, R _{BB} =2 Ω		-4	10	2	350	-	450	-	
I _{S/b}	30 100		5.9 0.35		1 1	-	1 1	-	s
h _{fe} f = 5 MHz	10		1		3	10	3	10	
f _T	10		1		15	50	15	50	MHz
C _{obo} f = 0.1 MHz	10 ^c				150	500	150	500	pF
t _d ^d		-6	10	2	-	0.1	-	0.1	μs
t _r ^d		-6	10	2	-	0.6	-	0.6	
t _s ^d		-6	10	2 ^e	-	2.5	-	2.5	
t _f ^d		-6	10	2 ^e	-	0.5	-	0.5	
t _c V _{CC} = 135 V, L=50 μH, R _C ≤ 13.5 Ω, Collector clamped to V _{CEX}		-6	10	2 ^e	-	0.5	-	0.5	

T_C = 100°C

I _{CEV}	450 650	-1.5 -1.5			-	1	-	-	mA
V _{CE(sat)}			10 ^a	2	-	2	-	2	
t _r ^d		-6	10	2	-	1	-	1	μs
t _s ^d		-6	10	2 ^e	-	4	-	4	
t _f ^d		-6	10	2 ^e	-	1	-	1	
t _c V _{CC} = 135 V, L=50 μH, R _C ≤ 13.5 Ω, Collector clamped to V _{CEX}		-6	10	2 ^e	-	0.8	-	0.8	

R _{θJC}	10		5		-	1	-	1	°C/W
------------------	----	--	---	--	---	---	---	---	------

^aPulsed: pulse duration = 300 μs, duty factor ≤ 2%.

^bCAUTION: The sustaining voltage V_{CEO(sus)} and V_{CEX} MUST NOT be measured on a curve tracer.

^cIn accordance with JEDEC registration data.

^dV_{CB} value.

^eV_{CC} = 135 V, t_p = 20 μs.

^fI_{B1} = -I_{B2}.

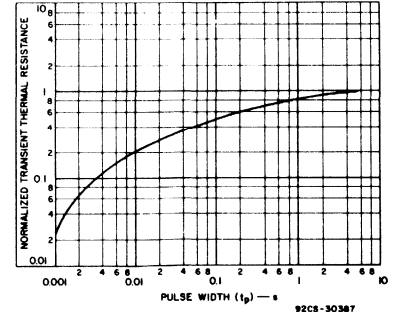


Fig. 4 - Typical thermal-response characteristic for both types.

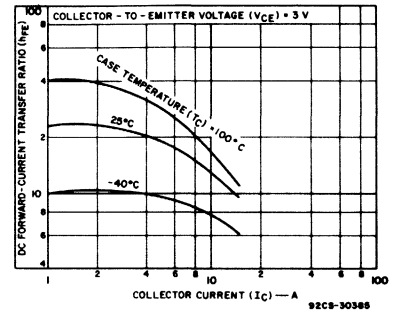


Fig. 5 - Typical dc beta characteristics for both types.

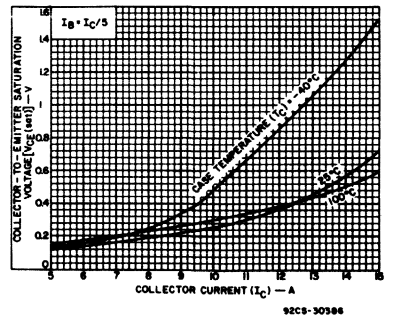


Fig. 6 - Typical collector-to-emitter saturation voltage characteristics for both types.

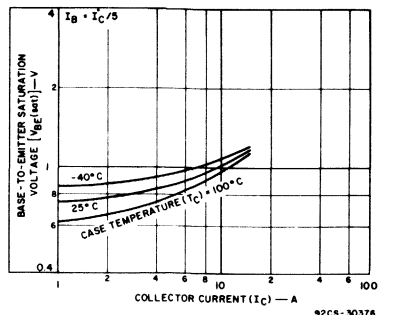


Fig. 7 - Typical base-to-emitter saturation voltage characteristics for both types.

2N6674, 2N6675

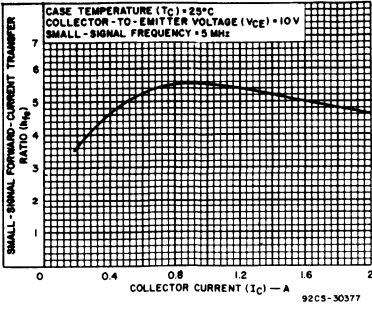


Fig. 8 - Typical small-signal forward current transfer ratio characteristic for both types ($f = 5 MHz$).

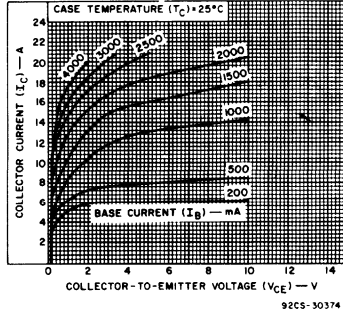


Fig. 9 - Typical output characteristics for both types.

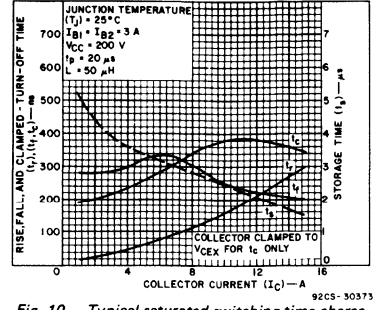


Fig. 10 - Typical saturated-switching-time characteristics at $T_J = 25^\circ C$ as a function of collector current for both types.

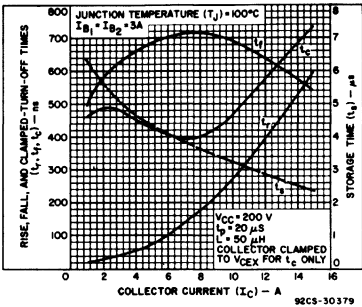


Fig. 11 - Typical saturated-switching-time characteristics at $T_J = 100^\circ C$ as a function of collector current for both types.

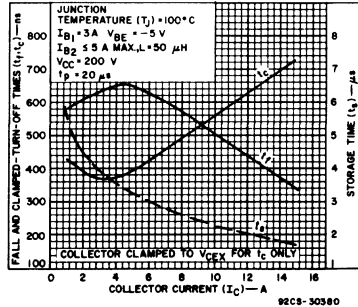


Fig. 12 - Typical saturated-switching-time characteristics at $T_J = 100^\circ C$ as a function of collector current for both types.

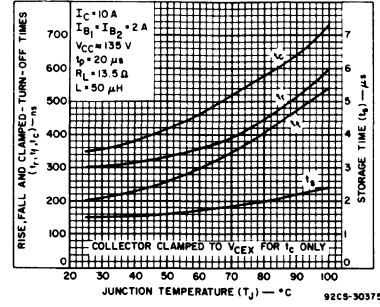


Fig. 13 - Typical saturated-switching-time characteristics as a function of junction temperature for both types.

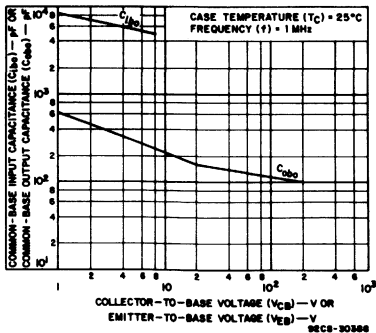


Fig. 14 - Typical common-base input (C_{ibo}) or output (C_{obo}) capacitance characteristics for both types.

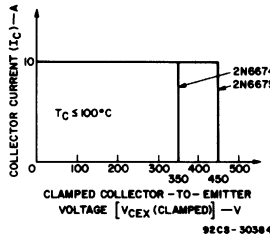


Fig. 15 - Maximum operating conditions for switching between saturation and cutoff for both types.

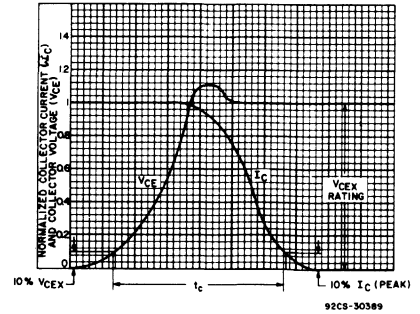


Fig. 16 - Oscilloscope display for normalized measurement of clamped inductive switching time (t_c).

2N6676, 2N6677, 2N6678

15-A *SwitchMax* Power Transistors

High-Voltage N-P-N Types for Off-Line Power Supplies and Other High-Voltage Switching Applications

The RCA-2N6676, 2N6677, and 2N6678* *SwitchMax* series of silicon n-p-n power transistors feature high-voltage capability, fast switching speeds, and low saturation voltages, together with high safe-operating-area (SOA) ratings. They are specially designed for off-line power supplies, converter circuits and pulse-width-modulated regulators. These high-voltage, high-speed transistors are 100-per-cent tested for parameters that are essential to the design of high-power

switching circuits. Switching time, including inductive turn-off time, and saturation voltages are tested at 100°C, as well as at 25°C, to provide information necessary for worst-case design.

The 2N6676, 2N6677, and 2N6678 transistors are supplied in steel JEDEC TO-204MA hermetic packages.

* Formerly RCA Dev. Type Nos. TA9114A, TA9114B, and TA9114C, respectively.

Features:

- 100% High-Temperature Tested for 100°C Parameters
- Fast Switching Speed
- High Voltage Ratings:
V_{CEX} = 350 V to 450 V
- Low V_{CE(sat)} at I_C = 15 A
- Steel Hermetic TO-204MA Package

Applications:

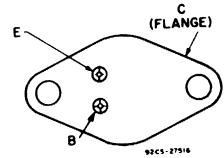
- Off-Line Power Supplies
- High-Voltage Inverters
- Switching Regulators

MAXIMUM RATINGS, Absolute-Maximum Values:

	2N6676	2N6677	2N6678	
* V _{CEV} V _{BE} = -1.5 V	450	550	650	V
* V _{CEX} (Clamped) V _{BE} = -1.5 V	350	400	450	V
* V _{CEO}	300	350	400	V
* V _{EBO}	8			V
I _{C(sat)}		15		A
* I _C		15		A
* I _{CM}		20		A
* I _B		5		A
* P _T				W
T _C up to 25°C		175		W
T _C above 25°C, derate linearly		1		W/°C
* T _{stg} , T _J		-65 to 200		°C
* T _L At distance ≥ 1/16 in. (1.58 mm) from seating plane for 10 s max.		235		°C

* In accordance with JEDEC registration data.

TERMINAL DESIGNATIONS



JEDEC TO-204MA

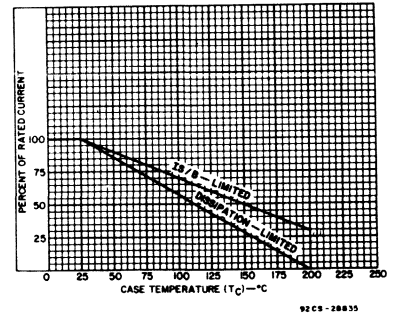


Fig. 2 - Dissipation and I_{S/B} derating curves for all types.

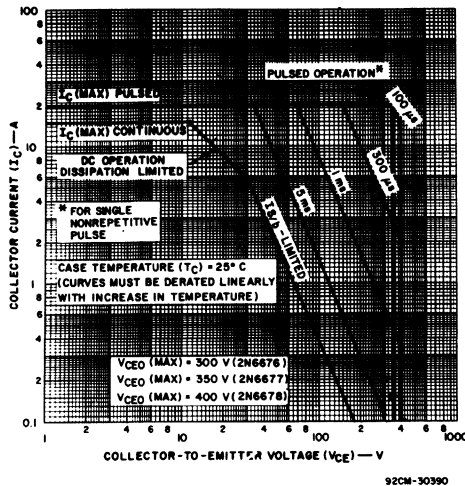


Fig. 1 - Maximum operating areas for all types (T_C = 25°C).

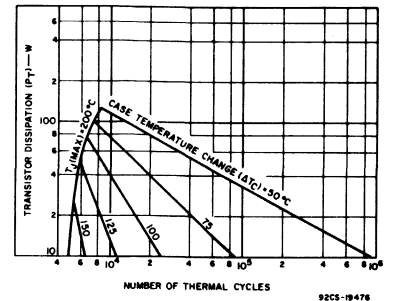


Fig. 3 - Thermal-cycling chart for all types.

2N6676, 2N6677, 2N6678

ELECTRICAL CHARACTERISTICS

CHARACTERISTIC	TEST CONDITIONS				LIMITS						UNITS
	VOLTAGE V dc		CURRENT A dc		2N6676		2N6677		2N6678		
	V _{CE}	V _{BE}	I _C	I _B	Min.	Max.	Min.	Max.	Min.	Max.	

T_C = 25°C

* I _{CEV}	450 550 650	-1.5 -1.5 -1.5			-	0.1	-	-	-	-	mA
* I _{EBO}		-8	0		-	2	-	2	-	2	
* V _{CE0(sus)} ^b			0.2 ^a	0	300	-	350	-	400	-	V
* h _{FE}	3		15 ^a		8	-	8	-	8	-	
* V _{BE(sat)}			15 ^a	3	-	1.5	-	1.5	-	1.5	V
* V _{CE(sat)}			15 ^a	3	-	1	-	1	-	1	V
* V _{CEX} ^b (Clamped E _S /b) L=50 μH, R _{BB} =2 Ω		-6	15	3	350	-	400	-	450	-	
* I _{S/b}	30 100		5.9 0.35		1 1	-	1 1	-	1 1	-	s
* h _{fe} f=5 MHz	10		1		3	10	3	10	3	10	
* f _T	10		1		15	50	15	50	15	50	MHz
* C _{obo} f=0.1 MHz	10 ^c				150	500	150	500	150	500	pF
* t _d ^d		-6	15	3	-	0.1	-	0.1	-	0.1	μs
* t _r ^d		-6	15	3	-	0.6	-	0.6	-	0.6	
* t _s ^d		-6	15	3 ^e	-	2.5	-	2.5	-	2.5	
* t _f ^d		-6	15	3 ^e	-	0.5	-	0.5	-	0.5	
* t _c ^f V _{CC} =200 V, L=50 μH, R _C ≤ 13.5 Ω		-6	15	3 ^e	-	0.5	-	0.5	-	0.5	

T_C = 100°C

* I _{CEV}	450 550 650	-1.5 -1.5 -1.5			-	1	-	-	-	-	mA
* V _{CE(sat)}			15 ^a	3	-	2	-	2	-	2	V
* t _r ^d		-6	15	3	-	1	-	1	-	1	μs
* t _s ^d		-6	15	3 ^e	-	4	-	4	-	4	
* t _f ^d		-6	15	3 ^e	-	1	-	1	-	1	
* t _c ^f V _{CC} =200 V, L=50 μH, R _C ≤ 13.5 Ω		-6	15	3 ^e	-	0.8	-	0.8	-	0.8	

* R _{θJC}	10		5		-	1	-	1	-	1	°C/W
--------------------	----	--	---	--	---	---	---	---	---	---	------

^aPulsed: pulse duration = 300 μs, duty factor ≤ 2%.

^bCAUTION: The sustaining voltage V_{CE0(sus)} and V_{CEX} MUST NOT be measured on a curve tracer.

^cIn accordance with JEDEC registration data.

^dV_{CB} value.

^eV_{CC} = 200 V, t_p = 20 μs.

^fI_{B1} = -I_{B2}.

^fCollector clamped to V_{CEX}.

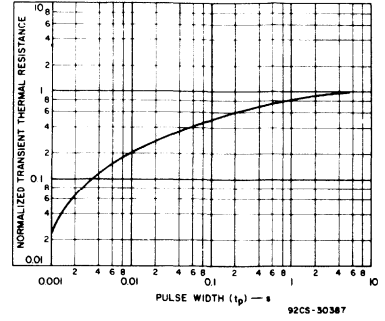


Fig. 4 - Typical thermal-response characteristic for all types.

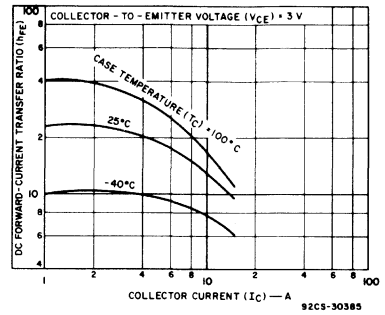


Fig. 5 - Typical dc beta characteristics for all types.

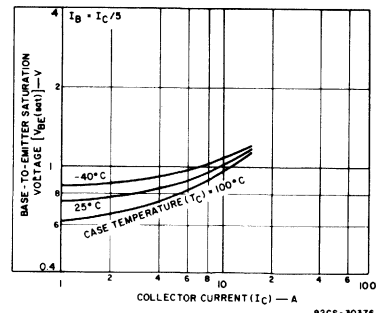


Fig. 6 - Typical base-to-emitter saturation voltage characteristics for all types.

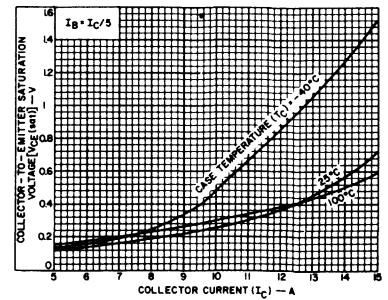


Fig. 7 - Typical collector-to-emitter saturation voltage characteristics for all types.

2N6676, 2N6677, 2N6678

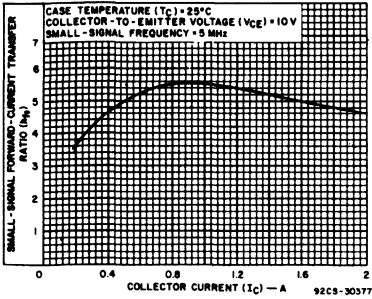


Fig. 8 - Typical small-signal forward current transfer ratio characteristic for all types ($f = 5\text{ MHz}$).

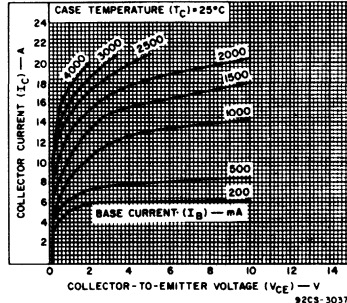


Fig. 9 - Typical output characteristics for all types.

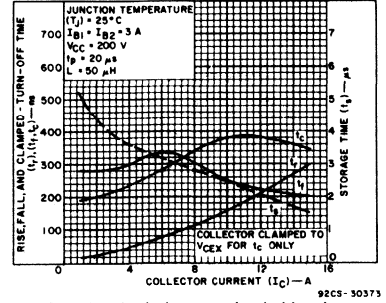


Fig. 10 - Typical saturated-switching-time characteristics at $T_J = 25^\circ\text{C}$ as a function of collector current for all types.

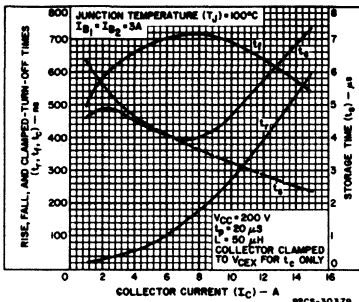


Fig. 11 - Typical saturated-switching-time characteristics at $T_J = 100^\circ\text{C}$ as a function of collector current for all types.

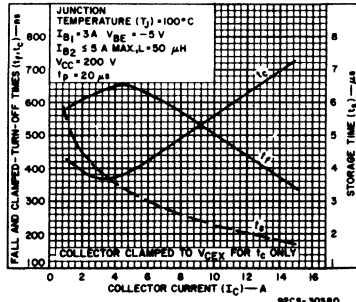


Fig. 12 - Typical saturated-switching-time characteristics at $T_J = 100^\circ\text{C}$ as a function of collector current for all types.

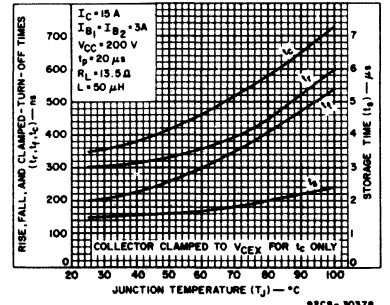


Fig. 13 - Typical saturated-switching-time characteristics as a function of junction temperature for all types.

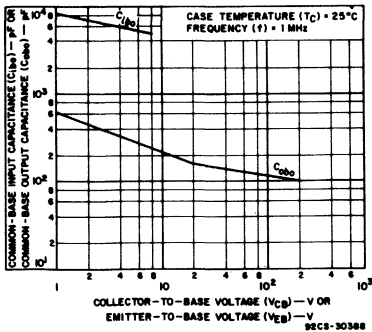


Fig. 14 - Typical common-base input (C_{ibo}) or output (C_{obo}) capacitance characteristics for all types.

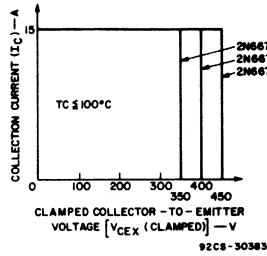


Fig. 15 - Maximum operating conditions for switching between saturation and cutoff for all types.

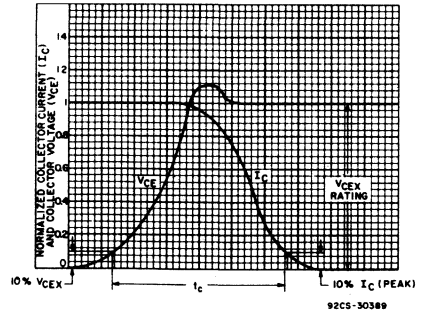


Fig. 16 - Oscilloscope display for normalized measurement of clamped inductive saturation switching time (t_c).

40310-40314, 40316-40319, 40321-40325, 40327, 40362, 40363, 40537-40539

Silicon Transistors for Audio-Frequency Linear-Amplifier Applications

These RCA transistors are diffused-junction silicon n-p-n and p-n-p types intended for specific applications in audio amplifiers. They provide high-quality economical performance in applications from low-level input stages to driver and power-output stages of 5 to 50 watts. Supply voltages range from the

nominal 12-volt vehicular type to 117-volt ac-dc type.

The use of all-silicon devices permits more flexibility in the mechanical and electrical design of amplifiers since the output heat sinks can be held to a minimum.

Features:

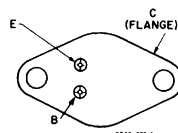
- Hermetically-sealed packages
- Pellet bonded to header — for greater power-handling capability for greater shock resistance
- Freedom from second breakdown
- 40319 and 40538 are p-n-p complements of 40317 and 40539, respectively

N-P-N TYPES IN TO-66 PACKAGE

MAXIMUM RATINGS, Absolute-Maximum Values:

	40310	40312	40313	40316	40318	40322	40324	
V_{CE0} (sus)	35	60	—	—	—	—	35	V
V_{CER} (sus)	—	—	300	40	300	300	—	V
At R_{BE}	—	—	500	500	500	500	—	Ω
V_{EBO}	2.5	2.5	2.5	5	6	6	2.5	V
I_C	4	4	2	4	2	2	4	A
I_B	2	2	1	2	1	1	2	A
P_T :								
$T_C \leq 25^\circ C$	29	29	35	29	35	35	29	W
$T_C > 25^\circ C$, derate linearly	0.17	0.17	0.2	0.17	0.2	0.2	0.17	W/ $^\circ C$
$T_C = 175^\circ C$	—	—	5	—	5	5	—	W
T_{stg}, T_J	—65 to 200							$^\circ C$
T_L (During soldering):								
At distances $\geq 1/16$ in. (1.58 mm) from case for 10 s max.	235							$^\circ C$

TERMINAL DESIGNATIONS



JEDEC TO-3

n-p-n

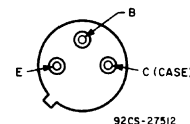
40325

40363

N-P-N TYPES IN TO-39 PACKAGE

MAXIMUM RATINGS, Absolute-Maximum Values:

	40311	40314	40317	40321	40323	40327	40539	
V_{CE0} (sus)	30	40	40	—	18	—	—	V
V_{CER} (sus)	—	—	—	300	—	300	55	V
At R_{BE}	—	—	—	500	—	1000	500	Ω
V_{EBO}	2.5	2.5	2.5	5	2.5	5	5	V
I_C	0.7	0.7	0.7	1	0.7	1	0.7	A
I_B	0.2	0.2	0.2	0.5	0.2	0.5	—	A
P_T :								
$T_C \leq 25^\circ C$	5	5	5	5	5	5	5	W
$T_C > 25^\circ C$, derate linearly				0.029				W/ $^\circ C$
$T_A \leq 25^\circ C$	1	1	1	1	1	1	1	W
T_{stg}, T_J	—65 to 200							$^\circ C$
T_L (During soldering):								
At distances $\geq 1/16$ in. (1.58 mm) from case for 10 s max.	300	300	300	255	300	255	255	$^\circ C$



JEDEC TO-39

n-p-n

40311

40314

40317

40321

40323

40327

40539

p-n-p

40319

40362

40537

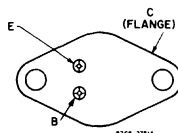
40538

N-P-N TYPES IN TO-39 PACKAGE

MAXIMUM RATINGS, Absolute-Maximum Values:

	40319	40362	40537	40538	40325	40363	
V_{CBO}	—	—	—	—	35	—	V
V_{CE0} (sus)	—40	—	—	—	35	—	V
V_{CER} (sus)	—	—70	—55	—55	—	70	V
At R_{BE}	—	200	500	500	—	200	Ω
V_{CEV} (sus)	—	—	—	—	35	—	V
At $V_{BE} = -1.5$ V	—	—	—	—	5	4	V
V_{EBO}	—2.5	—4	—5	—5	5	4	V
I_C	—0.7	—0.7	—0.7	—0.7	15	15	A
I_B	—0.2	—0.2	—0.2	—0.2	7	7	A
P_T :							
$T_C \leq 25^\circ C$	5	5	5	5	117	115	W
$T_C > 25^\circ C$, derate linearly	0.029	0.029	0.029	0.029	0.67	0.66	W/ $^\circ C$
$T_A \leq 25^\circ C$	1	1	1	1	—	—	W
T_{stg}, T_J	—65 to 200				—65 to 200		$^\circ C$
T_L (During soldering):							
At distances $\geq 1/16$ in. (1.58 mm) from case for 10 s max.	230				235		$^\circ C$

N-P-N TYPES IN TO-3 PACKAGE



JEDEC TO-66

n-p-n

40310 40316

40312 40318

40313 40322

40324

40310-40314, 40316-40319, 40321-40325, 40327, 40362, 40363, 40537-40539

Types: 40321, 40323, 40327, n-p-n

Package: JEDEC TO-39

ELECTRICAL CHARACTERISTICS, At Case Temperature (T_C) = 25°C Unless Otherwise Specified

CHARACTERISTIC	TEST CONDITIONS	LIMITS						UNITS
		40321		40323		40327		
		Min.	Max.	Min.	Max.	Min.	Max.	
I_{CBO}	$V_{CB}=15\text{ V}, I_E=0, T_C=25^\circ\text{C}$	—	—	—	0.25	—	—	μA
	$V_{CB}=150\text{ V}, I_E=0, T_C=150^\circ\text{C}$	—	0.1	—	1	—	0.1	mA
I_{CER}	$V_{CE}=150\text{ V}, R_{BE}=1000\ \Omega$	—	5	—	—	—	5	μA
I_{EBO}	$V_{BE}=-2.5\text{ V}$ (40323)	—	—	—	1	—	—	mA
	$V_{BE}=-5\text{ V}$ (40321, 40327)	—	0.1	—	—	—	0.1	
$V_{CEO(sus)}$	$I_C=100\text{ mA}^*$	—	—	18	—	—	—	V
$V_{CER(sus)}$	$I_C=50\text{ mA}^*, R_{BE}=1000\ \Omega$	300	—	—	—	300	—	V
V_{BE}	$V_{CB}=4\text{ V}, I_C=50\text{ mA}^*$ (40323)	—	—	—	1	—	—	V
	$V_{CB}=10\text{ V}, I_C=50\text{ mA}^*$ (40321, 40327)	—	2	—	—	—	2	
h_{FE}	$V_{CE}=4\text{ V}, I_C=50\text{ mA}^*$ (40323)	—	—	70	350	—	—	
	$V_{CE}=10\text{ V}, I_C=20\text{ mA}^*$ (40321, 40327)	25	200	—	—	40	250	
f_T	$V_{CE}=10\text{ V}, I_C=50\text{ mA}$	—	—	100 typ.		—	—	MHz
$R_{\theta JC}$		—	35	—	35	—	30	$^\circ\text{C/W}$
$R_{\theta JA}$		—	—	—	175	—	—	

* Pulsed: Pulse duration = 300 μs , duty factor $\leq 2\%$.

For characteristics curves and test conditions, refer to published data for prototype.

Audio Type	Prototype
40321	2N3439
40323	2N2102
40327	2N3439

Types: 40311, 40314, 40317, n-p-n 40319, p-n-p

Package: JEDEC TO-39

ELECTRICAL CHARACTERISTICS, At Case Temperature (T_C) = 25°C Unless Otherwise Specified

CHARACTERISTIC	TEST CONDITIONS [▲]	LIMITS						UNITS
		40311		40314		40317/40319 [●]		
		Min.	Max.	Min.	Max.	Min.	Max.	
I_{CBO}	$V_{CB}=15\text{ V}, I_E=0$	—	0.25	—	0.25	—	0.25	μA
	$T_C=25^\circ\text{C}$	—	1	—	1	—	1	mA
I_{EBO}	$V_{BE}=-2.5\text{ V}$	—	1	—	1	—	1	mA
$V_{CEO(sus)}$	$I_C=100\text{ mA}^*$	30	—	40	—	40	—	V
V_{BE}	$V_{CE}=4\text{ V}$	—	1	—	1	—	1	V
	$I_C=10\text{ mA}^*$ (40317); $I_C=50\text{ mA}$ (40311, 40314, 40319)	—	—	—	—	—	—	
$V_{CE(sat)}$	$I_C=150\text{ mA}^*, I_B=15\text{ mA}$	—	—	—	1.4	—	-1.4 [●]	V
h_{FE}	$V_{CE}=4\text{ V}$	—	—	—	—	40	200	
	$I_C=10\text{ mA}^*$ (40317); $I_C=50\text{ mA}^*$ (40311, 40314, 40319)	70	350	70	350	35 [●]	200 [●]	
f_T	$V_{CE}=10\text{ V}$ (40311); $V_{CE}=4\text{ V}$ (40314, 40319); $I_C=50\text{ mA}$	100 typ.		100 typ.		100 typ. [●]		MHz
$R_{\theta JC}$		—	35	—	35	—	35	$^\circ\text{C/W}$
$R_{\theta JA}$		—	175	—	175	—	175	

[▲] For p-n-p devices, voltage and current are negative.[●] 40319 *Pulsed: Pulse duration = 300 μs , duty factor $\leq 2\%$.

For characteristics curves and test conditions, refer to published data for prototype.

Audio Type	Prototype
40311	2N2102
40314	2N2102
40317	2N2102
40319	2N4036

**40310-40314, 40316-40319, 40321-40325,
40327, 40362, 40363, 40537-40539**

Types: 40362, 40537, 40538, p-n-p 40539, n-p-n

Package: JEDEC TO-39

ELECTRICAL CHARACTERISTICS, At Case Temperature (T_C) = 25°C Unless Otherwise Specified

CHARACTERISTIC	TEST CONDITIONS*	LIMITS						UNITS
		40362		40537		40538 40539*		
		Min.	Max.	Min.	Max.	Min.	Max.	
I_{CER}	$V_{CE}=-45\text{ V}, R_{BE}=500\ \Omega,$ $T_C=25^\circ\text{C}$	-	-	-	-10	-	-10	μA
	$V_{CE}=-65\text{ V}, R_{BE}=1000\ \Omega,$ $T_C=25^\circ\text{C}$	-	-1	-	-	-	-	
	$V_{CE}=-60\text{ V}, R_{BE}=1000\ \Omega,$ $T_C=150^\circ\text{C}$	-	-100	-	-	-	-	
I_{EBO}	$V_{BE}=4\text{ V}$	-	-1	-	-	-	-	mA
	$V_{BE}=5\text{ V}$	-	-	-	-1	-	-1	
$V_{CER(sus)}$	$I_C=-100\text{ mA}^*, R_{BE}=500\ \Omega$	-	-	-55	-	-55	-	V
	$I_C=-100\text{ mA}^*, R_{BE}=1000\ \Omega$	-70	-	-	-	-	-	
V_{BE}	$V_{CE}=-4\text{ V}, I_C=-50\text{ mA}^*$	-	-1	-	-1.8	-	-	V
	$V_{CE}=-4\text{ V}, I_C=-500\text{ mA}^*$	-	-	-	-	-	-2.7	
$V_{CE(sat)}$	$I_C=-50\text{ mA}^*, I_B=-5\text{ mA}$	-	-	-	-1.1	-	-	V
	$I_C=-150\text{ mA}^*, I_B=-15\text{ mA}$	-	-1.4	-	-	-	-	
	$I_C=-500\text{ mA}^*, I_B=-50\text{ mA}$	-	-	-	-	-	-2	
h_{FE}	$V_{CE}=-4\text{ V}, I_C=-50\text{ mA}^*$	35	200	50	300	-	-	
	$V_{CE}=-4\text{ V}, I_C=-500\text{ mA}^*$	-	-	-	-	15	90	
f_T	$V_{CE}=-4\text{ V}, I_C=-50\text{ mA}$	100 typ.		100 typ.		100 typ.		MHz
$R_{\theta JC}$		-	35	-	-	-	35 [▲]	°C/W
$R_{\theta JA}$		-	175	-	175	-	175	

* For n-p-n devices, voltage and current are positive.

▲ 40539 *Pulsed: Pulse duration = 300 μs , duty factor $\leq 2\%$.

For characteristics curves and test conditions, refer to published data for prototype.

Audio	Type	Prototype
	40362	2N4036
	40531	2N4036
	40538	2N5322
	40539	2N5320

Types: 40310, 40312, 40316, 40324, n-p-n

Package: JEDEC TO-66

ELECTRICAL CHARACTERISTICS, At Case Temperature (T_C) = 25°C Unless Otherwise Specified

CHARACTERISTIC	TEST CONDITIONS	LIMITS						UNITS
		40310		40316		40324		
		40312	40316	40316	40324	40324	40324	
I_{CB0}	$V_{CB}=15\text{ V}, I_E=0$							μA
	$T_C=25^\circ\text{C}$	-	10	-	10	-	10	
	$T_C=150^\circ\text{C}$	-	5	-	5	-	5	
I_{EBO}	$V_{BE}=-2.5\text{ V}$	-	5	-	-	-	5	mA
	$V_{BE}=-5\text{ V}$	-	-	-	5	-	-	
$V_{CEO(sus)}$	$I_C=100\text{ mA}^*$	35*	-	-	-	35	-	V
$V_{CER(sus)}$	$I_C=100\text{ mA}^*, R_{BE}=500\ \Omega$	60 [#]	-	40	-	-	-	V
V_{BE}	$V_{CE}=2\text{ V}, I_C=1\text{ A}^*$	-	1.4	-	1.4	-	1.4	V
h_{FE}	$V_{CE}=2\text{ V}, I_C=1\text{ A}^*$	20	120	20	120	20	120	
f_T	$V_{CE}=4\text{ V}, I_C=500\text{ mA}$	750 typ.		750 typ.		750 typ.		kHz
$R_{\theta JC}$		-	6	-	6	-	6	°C/W

* 40310 # 40312 *Pulsed: Pulse duration = 300 μs , duty factor $\leq 2\%$.

For characteristics curves and test conditions, refer to published data for prototype.

Audio	Type	Prototype
	40310	2N3054
	40312	2N3054
	40316	2N3054
	40324	2N3054

40310-40314, 40316-40319, 40321-40325, 40327, 40362, 40363, 40537-40539

Types: 40313, 40318, 40322, n-p-n

Package: JEDEC TO-66

ELECTRICAL CHARACTERISTICS, At Case Temperature (T_C) = 25°C Unless Otherwise Specified

CHARACTERISTIC	TEST CONDITIONS	LIMITS						UNITS
		40313		40318		40322		
		Min.	Max.	Min.	Max.	Min.	Max.	
I_{CEO}	$V_{CE}=150\text{ V}, I_B=0$	—	5	—	5	—	—	mA
I_{CEV}	$V_{CE}=150\text{ V}$ (40318), $V_{CE}=300\text{ V}$ (40313), $V_{BE}=-1.5\text{ V}$, $T_C=25^\circ\text{C}$, $T_C=150^\circ\text{C}$	—	10	—	5	—	—	mA
		—	10	—	10	—	—	
I_{EBO}	$V_{BE}=-2.5\text{ V}$, $V_{BE}=-6\text{ V}$	—	5	—	—	—	—	mA
		—	—	—	5	—	5	
$V_{CER(sus)}$	$I_C=200\text{ mA}^*$, $R_{BE}=200\ \Omega$, $L=500\text{ mH}$	300	—	300	—	300	—	V
V_{BE}	$V_{CE}=10\text{ V}$, $I_C=100\text{ mA}^*$, $I_C=500\text{ mA}^*$	—	1.5	—	—	—	—	V
		—	—	—	1.5	—	—	
h_{FE}	$V_{CE}=10\text{ V}$, $I_C=500\text{ mA}^*$, $I_C=100\text{ mA}^*$, $I_C=20\text{ mA}^*$	40	—	50	—	75	—	
		40	250	—	—	—	—	
		—	—	40	—	40	—	
$I_{S/b}$	$V_{CE}=150\text{ V}$	150	—	100	—	100	—	mA
$E_{S/b}$	$V_{BE}=-4\text{ V}$	—	—	50	—	50	—	μJ
$R_{\theta JC}$		—	5	—	5	—	5	$^\circ\text{C/W}$

* Pulsed: Pulse duration = 300 μs , duty factor $\leq 2\%$.

For characteristics curves and test conditions, refer to published data for prototype.

Audio Type	Prototype
40313	2N3585
40318	2N3585
40322	2N3585

Types: 40325, 40363, n-p-n

Package: JEDEC TO-3

ELECTRICAL CHARACTERISTICS, At Case Temperature (T_C) = 25°C Unless Otherwise Specified

CHARACTERISTIC	TEST CONDITIONS	LIMITS				UNITS
		40325		40363		
		Min.	Max.	Min.	Max.	
I_{CBO}	$V_{CB}=30\text{ V}$, $T_C=25^\circ\text{C}$, $T_C=150^\circ\text{C}$	—	5	—	—	mA
		—	10	—	—	
I_{CER}	$V_{CE}=60\text{ V}$, $R_{BE}=200\ \Omega$, $T_C=25^\circ\text{C}$, $T_C=150^\circ\text{C}$	—	—	—	1	mA
		—	—	—	10	
I_{EBO}	$V_{BE}=-5\text{ V}$, $V_{BE}=-4\text{ V}$	—	10	—	—	mA
		—	—	—	5	
$V_{CEO(sus)}$	$I_C=200\text{ mA}^*$	35	—	—	—	V
$V_{CER(sus)}$	$I_C=200\text{ mA}^*$, $R_{BE}=200\ \Omega$	—	—	70	—	V
V_{CBO}	$I_C=100\text{ mA}$, $I_E=0$	35	—	—	—	V
V_{BE}	$V_{CE}=4\text{ V}$, $I_C=8\text{ A}^*$, $I_C=4\text{ A}^*$	—	2	—	—	V
		—	—	—	1.8	
$V_{CE(sat)}$	$I_C=8\text{ A}^*$, $I_B=800\text{ mA}$, $I_C=4\text{ A}^*$, $I_B=400\text{ mA}$	—	1.5	—	—	V
		—	—	—	1.1	
h_{FE}	$V_{CE}=4\text{ V}$, $I_C=8\text{ A}^*$, $I_C=4\text{ A}^*$	12	60	—	—	
		—	—	20	70	
f_T	$V_{CE}=4\text{ V}$, $I_C=3\text{ A}$	—	—	700 typ.	—	kHz
$R_{\theta JC}$		—	1.5	—	1.5	$^\circ\text{C/W}$

* Pulsed: Pulse duration = 300 μs , duty factor $\leq 2\%$.

For characteristics curves and test conditions, refer to published data for prototype.

Audio Type	Prototype
40325	2N3055
40363	2N3055

40406, 40408, 40410, 40407, 40409, 40411

Silicon N-P-N and P-N-P Power Transistors

For Audio-Amplifier Applications

RCA-40406-40411, inclusive, are diffused-junction silicon n-p-n and p-n-p transistors intended for use in audio amplifiers. Giving high-quality performance economically, these six devices have power dissipation ratings of 1 to 150 W. Types 40406, 40407, and

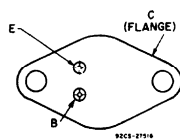
40408 are supplied in JEDEC TO-39 hermetic packages; types 40409 and 40410 are in TO-39 packages mounted on integral heat radiators. The 40411 unit, intended for use in audio output stages, is in a steel JEDEC TO-3 hermetic package.

Features:

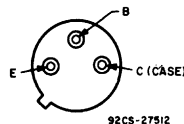
- 40406 & 40407
 - $V_{CE0}(sus) = -50\text{ V max. (40406)}$
 - $V_{CE0}(sus) = 50\text{ V max. (40407)}$
 - 40406 is p-n-p complement of 40407
 - 1 W dissipation rating
- 40408
 - $V_{CE0}(sus) = 90\text{ V max.}$
 - 1 W dissipation rating
- 40409 & 40410
 - $V_{CE0}(sus) = 90\text{ V max. (40409)}$
 - $V_{CE0}(sus) = -90\text{ V max. (40410)}$
 - 40410 is p-n-p complement of 40409
 - 3 W free-air dissipation rating
- 40411
 - $V_{CE0}(sus) = 90\text{ V max.}$
 - Hometaxial-base construction
 - 150 W dissipation rating

	40406	40407	40408	40409	40410	40411	
$V_{CE0}(sus)$	-50	50	90	—	—	—	V
$V_{CE0}(sus)$	—	—	—	90	-90	90	V
$R_{BE} = 100\ \Omega$							
V_{EBO}	-4	4	4	4	-4	4	V
I_C	-0.7	0.7	0.7	0.7	-0.7	30	A
I_B	-0.2	0.2	0.2	0.2	-0.2	15	A
P_T :							
$T_A < 25^\circ\text{C}$	1	1	1	—	—	—	W
$T_A < 50^\circ\text{C}$	—	—	—	3	3	—	W
$T_C < 25^\circ\text{C}$	—	—	—	—	—	150	W
T_J	-65 to +200						$^\circ\text{C}$

TERMINAL DESIGNATIONS



JEDEC TO-3



JEDEC TO-39

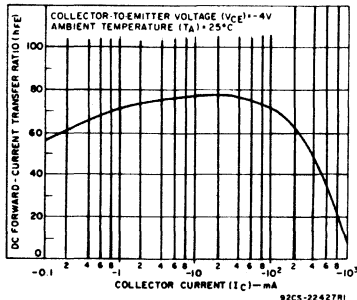


Fig. 1 — Typical dc beta characteristic for 40406 and 40410.

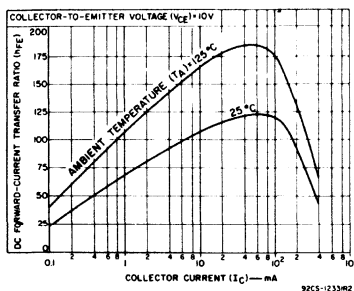


Fig. 2 — Typical dc beta characteristics for 40407, 40408, and 40409.

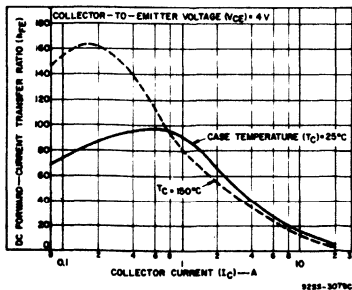


Fig. 3 — Typical dc beta characteristics for 40411.

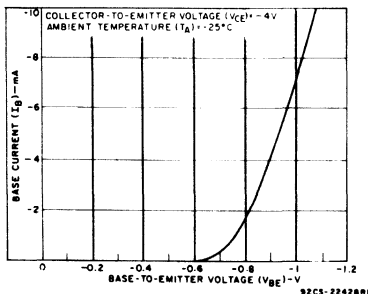


Fig. 4 — Typical input characteristic for 40406 and 40410.

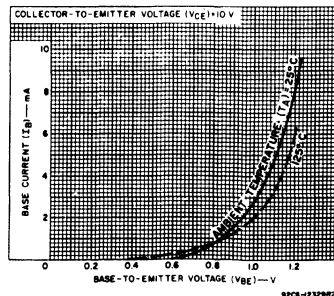


Fig. 5 — Typical input characteristics for 40407, 40408, and 40409.

40406, 40408, 40410, 40407, 40409, 40411

ELECTRICAL CHARACTERISTICS, $T_C = 25^\circ$ Unless Otherwise Specified

CHARACTERISTIC	TEST CONDITIONS			LIMITS						UNITS		
	VOLTAGE V dc	CURRENT A dc		40406# 40407		40408		40409 40410#			40411	
		V _{CE}	I _C	I _B	Min.	Max.	Min.	Max.	Min.		Max.	Min.
I _{CBO} I _E = 0	10*			-	0.25*	-	-	-	-	-	-	μA
I _{CEO}	40 80			-	1	-	-	1	-	-	-	μA
T _C = 150° C												
40406	40			-	0.01	-	-	-	-	-	-	mA
40407	40			-	0.1	-	-	-	-	-	-	
40408	80			-	-	-	0.25	-	-	-	-	
I _{CER} R _{BE} = 100 Ω	80			-	-	-	-	-	1	-	500	μA
T _C = 150° C	80			-	-	-	-	-	0.1	-	2	mA
I _{EBO} V _{BE} = -4 V		0		-	100	-	100	-	100	-	500	μA
V _{CEO} (sus)		0.1 ^a	0	50 ^b	-	90 ^b	-	-	-	-	-	V
V _{CER} (sus) R _{BE} = 100 Ω		0.1 0.2		-	-	-	-	-	-	-	90	V
V _{BE}	10 4 4 4	0.001 ^a 0.01 ^a 0.15 ^a 4 ^a		-	0.8 ^c	-	-	1	-	1	-	V
V _{CE} (sat)		0.15 ^a 4 ^a	0.015 0.4	-	-	-	1.4	-	1.4	-	-	V
h _{FE}	40406	10	0.1 mA ^a	30	200	-	-	-	-	-	-	
	40407	10	0.001 ^a	40	200	-	-	-	-	-	-	
	40408	4	0.01 ^a	-	40	200	-	-	-	-	-	
	40409-10	4	0.15 ^a	-	-	-	50	250	-	-	-	
	40411	4	4 ^a	-	-	-	-	-	35	100	-	
h _{fe} f = 20 MHz	10	0.05		6 ^b	-	-	-	-	-	-	-	
f _T	4	0.05		100 (typ.)	100 (typ.)	100 (typ.)	-	-	-	-	800 (typ.)	MHz
C _{obo} I _E = 0 f = 1 MHz	10*			15 ^b	-	-	-	-	-	-	-	pF
I _{S/b} t = 1s nonrep	40			-	-	-	-	5*	-	-	-	A
R _{θJC}				-	35	-	35	-	-	-	1.17	°C/W
R _{θJA}				-	175	-	175	-	50	-	-	

For p-n-p devices, voltage and current values are negative
 • V_{CB} • 40407 only * 40410 only
 a Pulsed; pulse duration = 300 μs, duty factor ≤ 2%

b CAUTION: The sustaining voltage V_{CEO}(sus) MUST NOT be measured on a curve tracer. V_{CEO}(sus) should be measured by the pulse method (Note 'a').
 c 40406 tested at I_C = -0.1 mA

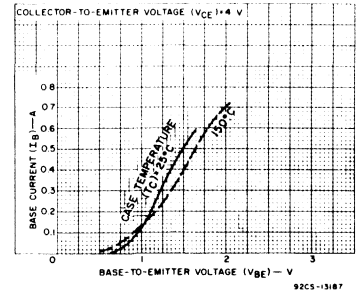


Fig. 6 – Typical input characteristics for 40411.

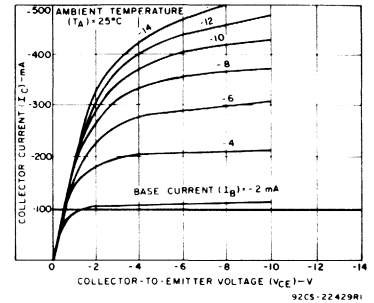


Fig. 7 – Typical output characteristics for 40406 and 40410.

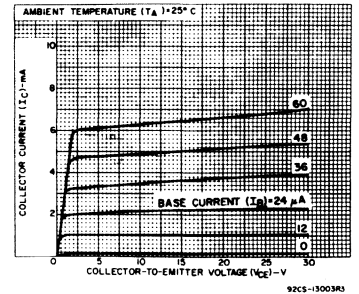


Fig. 8 – Typical output characteristics for 40407, 40408, and 40409.

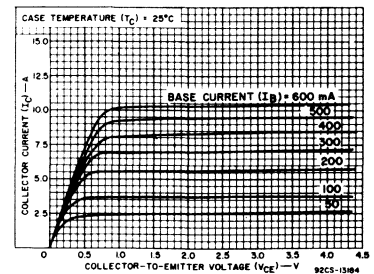


Fig. 9 – Typical output characteristics for 40411.

40631, 41504

Hometaxial-Base Silicon N-P-N VERSAWATT Transistors

Designed for Medium-Power
Linear and Switching Applications

The RCA-40631 and 41504 are hometaxial-base silicon n-p-n transistors intended for a wide variety of medium-power applications. The hometaxial-base construction of these devices renders them highly resistant to second breakdown over a wide range of operating conditions. Type 40631 is intended especially for use in driver and output stages in high-fidelity audio-amplifier circuits; the 41504 is a general-purpose device.

Both of these transistor types are supplied in the VERSAWATT flame-retardant plastic package. The 40631 is supplied in the JEDEC TO-220AA formed-lead version of this package for use with TO-66 sockets; the 41504 is supplied in the JEDEC TO-220AB, straight-lead version.

Features:

- Low saturation voltages
- High dissipation ratings

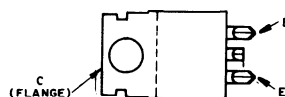
Applications:

- Series and shunt regulators
- High-fidelity amplifiers
- Power-switching circuits
- Solenoid drivers

MAXIMUM RATINGS, Absolute-Maximum Values:

	40631	41504	
$V_{CE(sus)}$	45	35	V
$R_{BE} = 100 \Omega$	5	4	V
V_{EBO}	4	4	A
I_C	2	2	A
I_B			
P_T :			
At $T_C \leq 25^\circ C$	36	36	W
At $T_C > 25^\circ C$	Derate linearly		W/ $^\circ C$
At $T_A \leq 25^\circ C$	1.8	-	W
T_J, T_{stg}	-65 to +150		$^\circ C$
T_L			
At distances $\geq 1/32$ in. (0.8 mm) from seating plane for 10 s max.	235		$^\circ C$

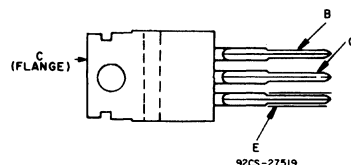
TERMINAL DESIGNATIONS



92CS-27520

BOTTOM VIEW

JEDEC TO-220AA



92CS-27519

BOTTOM VIEW

JEDEC TO-220AB

ELECTRICAL CHARACTERISTICS, At Case Temperature (T_C) = 25 $^\circ C$

CHARACTERISTIC	TEST CONDITIONS				LIMITS				UNITS
	VOLTAGE V dc		CURRENT A dc		40631		41504		
	V_{CE}	V_{BE}	I_C	I_B	Min.	Max.	Min.	Max.	
I_{CER} $R_{BE} = 100 \Omega$	20 40				-	-	-	5	mA
I_{EBO}		-4 -5	0 0		-	-	-	1	mA
$V_{CE(sus)}$ $R_{BE} = 100 \Omega$			0.1 ^a 0.2 ^a		-	-	35	-	V
h_{FE}	4 4		1 ^a 2 ^a		-	-	25	-	
$V_{CE(sat)}$			1 ^a 2 ^a	0.05 0.2	-	-	1	-	V
V_{BE}	4 4		1 ^a 2 ^a		-	-	1.5	-	V
$ h_{fe} $ $f = 0.4$ MHz	4		0.2		2	-	2	-	
$R_{\theta JC}$					-	3.5	-	3.5	$^\circ C/W$
$R_{\theta JA}$					-	70	-	70	

^a Pulsed: Pulse duration = 300 μs , duty factor $\leq 2\%$.

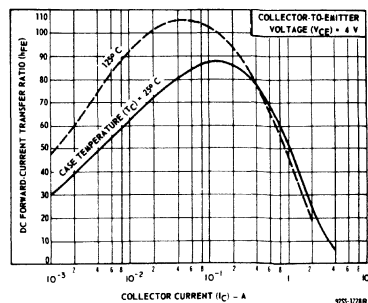


Fig. 1 - Typical dc beta characteristics for 40631.

40631, 41504

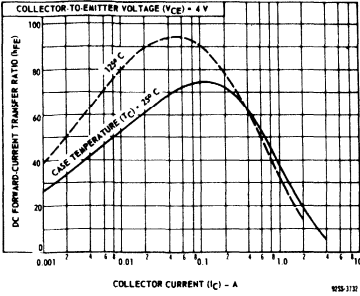


Fig. 2 – Typical dc beta characteristics for 41504.

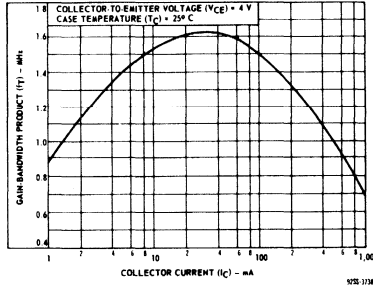


Fig. 3 – Typical gain-bandwidth product for 40631.

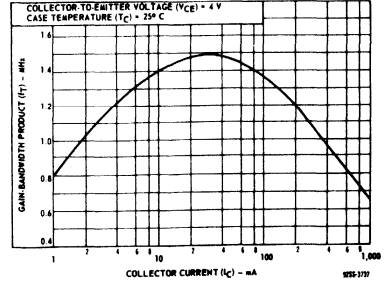


Fig. 4 – Typical gain-bandwidth product for 41504.

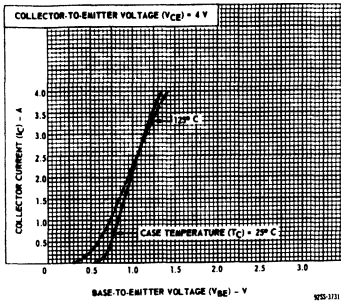


Fig. 5 – Typical transfer characteristics for 40631.

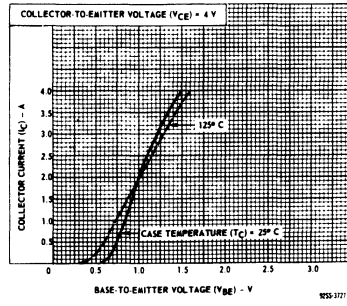


Fig. 6 – Typical transfer characteristics for 41504.

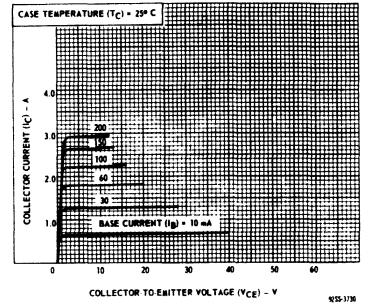


Fig. 7 – Typical output characteristics for 40631.

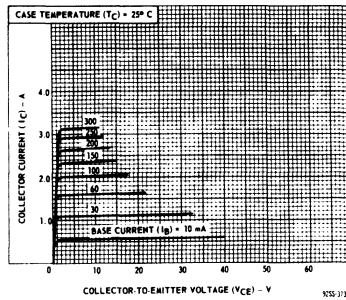


Fig. 8 – Typical output characteristics for 41504.

40850, 40851, 40852, 40854

450-V Silicon N-P-N Power Transistors

For Off-Line Switching-Regulator Type Power-Supply Applications

The RCA-40850, 40851, 40852, and 40854 are n-p-n types selected from RCA's line of silicon power transistors for power-supply applications. Their high-voltage ratings permit operation directly off the power line thereby eliminating the heavy and bulky 60-Hz power transformer; their fast switching speeds permit operation above the audio-frequency range (20 to 30 KHz) for quiet performance and permit the use of small ferrite-core transformers for changing voltage levels.

These devices have sufficient voltage capability to be used as push-pull inverters or pulse-width-modulated inverters operating directly off the 120-V power line; they can operate as switching regulators off a 240-V line; for 120-V lines, the prototypes can be used.

MAXIMUM RATINGS, Absolute-Maximum Values:

	40850	40851	40852	40854	
V _{CB0}	450	450	450	450	V
V _{CEO(sus)}	300	350	350	300	V
V _{CER(sus)}					
R _{BE} < 50 Ω	400	375	375	325	V
V _{EBO}	6	9	9	6	V
I _C	2	7	7	15	A
I _{CM} (For 10 ms max.)	5	10	10	30	A
I _B	1	4	4	10	A
P _T *					
T _C < 25°C	35	45	100	175	W
T _C > 25°C	Derate linearly to 200°C				
T _J , T _{stg}	-65 to +200				°C
T _L (During soldering): At distances ≥ 1/32 in. (0.8 mm) from case for 10 s max.	230				°C

* Safe-operating-area curves for prototype devices should be extended to the maximum values of collector current for these devices.

Type 40850 (For 5-V, 25-A & 30-V, 5-A Power Supplies)

Package: JEDEC TO-66

ELECTRICAL CHARACTERISTICS, At Case Temperature (T_C) = 25°C,

Unless Otherwise Specified

SYMBOL	TEST CONDITIONS	LIMITS		UNITS
		MIN.	MAX.	
I _{CEV}	V _{CE} = 450 V, V _{BE} = -1.5 V	-	0.2	mA
I _{CEV}	V _{CE} = 450 V, V _{BE} = -1.5 V, T _C = 125°C	-	2	mA
V _{CEO(sus)} ^a	I _C = 0.2 A, I _B = 0	300	-	V
V _{CER(sus)} ^a	I _C = 0.2 A, R _{BE} = 50 Ω	400	-	V
V _{EBO}	I _E = 5 mA, I _C = 0	6	-	V
h _{FE}	I _C = 0.75 A, V _{CE} = 10 V	25	-	
V _{CE(sat)}	I _C = 2 A, I _B = 0.4 A	-	2.0	V
V _{BE(sat)}	I _C = 2 A, I _B = 0.4 A	-	2.0	V
I _{S/b} ^a	V _{CE} = 100 V	0.35	-	A
ES/b ^a	L = 100 μH, I _{C(PEAK)} = 2 A, R _{BE} = 20 Ω V _{BE} = -4 V	0.2	-	mJ

^a For characteristics curves and test conditions, refer to published data for prototype 2N3585

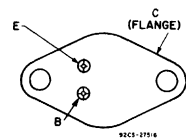
Features:

- High-voltage ratings for operation from power lines without a step-down transformer
- Popular JEDEC TO-3 and TO-66 hermetic packages

Applications:

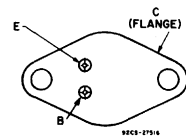
- For use in switching-regulator supplies which feature:
 - A substantial reduction in size and weight due to elimination of the 60-Hz power transformer.
 - Operation with a substantial reduction of heat.
- 5-V, off-line supplies with current ratings of 25, 50, 100, or 200 A
- 30-V, off-line supplies with current ratings of 5, 10, 20, or 40 A

TERMINAL DESIGNATIONS



JEDEC TO-3

40852
40853



JEDEC TO-66

40850
40851

40850, 40851, 40852, 40854

Type 40851 (For 5-V, 50-A & 30-V, 10-A Power Supplies)

Package: JEDEC TO-66

ELECTRICAL CHARACTERISTICS, At Case Temperature (T_C) = 25°C,*Unless Otherwise Specified*

SYMBOL	TEST CONDITIONS	LIMITS		UNITS
		MIN.	MAX.	
I_{CEV}	$V_{CE} = 450\text{ V}, V_{BE} = -1.5\text{ V}$	–	0.5	mA
I_{CEV}	$V_{CE} = 450\text{ V}, V_{BE} = -1.5\text{ V}, T_C = 125^\circ\text{C}$	–	5	mA
$V_{CEO}(\text{sus})^a$	$I_C = 0.2\text{ A}, I_B = 0$	350	–	V
$V_{CER}(\text{sus})^a$	$I_C = 0.2\text{ A}, R_{BE} = 50\ \Omega$	375	–	V
V_{EBO}	$I_E = 1\text{ mA}, I_C = 0$	9	–	V
h_{FE}	$I_C = 1.2\text{ A}, V_{CE} = 1.0\text{ V}$	12	–	
$V_{CE}(\text{sat})$	$I_C = 4\text{ A}, I_B = 0.8\text{ A}$	–	3	V
$V_{BE}(\text{sat})$	$I_C = 4\text{ A}, I_B = 0.8\text{ A}$	–	2	V
I_S/b^a	$V_{CE} = 50\text{ V}$	0.9	–	A
E_S/b^a	$L = 100\ \mu\text{H}, I_C(\text{PEAK}) = 3\text{ A}, R_{BE} = 50\ \Omega$ $V_{BE} = -4\text{ V}$	0.45	–	mJ

^a For characteristics curves and test conditions, refer to published data for prototype 2N6079

Type 40852 (For 5-V, 50-A & 30-V, 10-A Power Supplies)

Package: JEDEC TO-3

ELECTRICAL CHARACTERISTICS, At Case Temperature (T_C) = 25°C,*Unless Otherwise Specified*

SYMBOL	TEST CONDITIONS	LIMITS		UNITS
		MIN.	MAX.	
I_{CEV}	$V_{CE} = 450\text{ V}, V_{BE} = -1.5\text{ V}$	–	0.5	mA
I_{CEV}	$V_{CE} = 450\text{ V}, V_{BE} = -1.5\text{ V}, T_C = 125^\circ\text{C}$	–	5	mA
$V_{CEO}(\text{sus})^a$	$I_C = 0.2\text{ A}, I_B = 0$	350	–	V
$V_{CER}(\text{sus})^a$	$I_C = 0.2\text{ A}, R_{BE} = 50\ \Omega$	375	–	V
V_{EBO}	$I_E = 1\text{ mA}, I_C = 0$	9	–	V
h_{FE}	$I_C = 1.2\text{ A}, V_{CE} = 1.0\text{ V}$	12	–	
$V_{CE}(\text{sat})$	$I_C = 4\text{ A}, I_B = 0.8\text{ A}$	–	3.0	V
$V_{BE}(\text{sat})$	$I_C = 4\text{ A}, I_B = 0.8\text{ A}$	–	2.0	V
I_S/b^a	$V_{CE} = 40\text{ V}$	2.5	–	A
E_S/b^a	$L = 100\ \mu\text{H}, I_C(\text{PEAK}) = 3\text{ A}, R_{BE} = 50\ \Omega$ $V_{BE} = -4\text{ V}$	0.45	–	mJ

^a For characteristics curves and test conditions, refer to published data for prototype 2N5240

40850, 40851, 40852, 40854

Type 40854 (For 5-V, 200-A & 30-V, 40-A Power Supplies)

Package: JEDEC TO-3

ELECTRICAL CHARACTERISTICS, At Case Temperature (T_C) = 25°C,

Unless Otherwise Specified

SYMBOL	TEST CONDITIONS	LIMITS		UNITS
		MIN.	MAX.	
I_{CEV}	$V_{CE} = 450 \text{ V}$, $V_{BE} = -1.5 \text{ V}$	—	1.0	mA
I_{CEV}	$V_{CE} = 450 \text{ V}$, $V_{BE} = -1.5 \text{ V}$, $T_C = 125^\circ\text{C}$	—	10	mA
$V_{CEO(sus)}^a$	$I_C = 0.2 \text{ A}$, $I_B = 0$	300	—	V
$V_{CER(sus)}^a$	$I_C = 0.2 \text{ A}$, $R_{BE} = 50 \Omega$	325	—	V
V_{EBO}	$I_E = 5 \text{ mA}$, $I_C = 0$	6	—	V
h_{FE}	$I_C = 10 \text{ A}$, $V_{CE} = 4 \text{ V}$	8	—	
$V_{CE(sat)}$	$I_C = 16 \text{ A}$, $I_B = 3.2 \text{ A}$	—	3	V
$V_{BE(sat)}$	$I_C = 16 \text{ A}$, $I_B = 3.2 \text{ A}$	—	3	V
I_S/b^a	$V_{CE} = 30 \text{ V}$	5.8	—	A
E_S/b^a	$L = 50 \mu\text{H}$, $I_C(\text{PEAK}) = 10 \text{ A}$, $R_{BE} = 50 \Omega$ $V_{BE} = -4 \text{ V}$	2.5	—	mJ

^a For characteristics curves and test conditions, refer to published data for prototype 2N6251

40871, 40872

Epitaxial-Base, Silicon N-P-N and P-N-P VERSAWATT Transistors

General-Purpose Types for Medium-Power Switching and Amplifier Service in Consumer, Automotive, and Industrial Applications

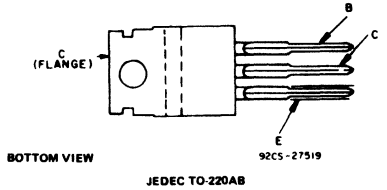
RCA-40871 is an epitaxial-base silicon n-p-n transistor. RCA-40872 is an epitaxial-base p-n-p transistor. These devices are intended for a wide variety of medium-power switching and amplifier applications, such as switching

regulators and inverters and driver and output stages of high-fidelity amplifiers. These plastic power transistors are supplied in the JEDEC TO-220AB VERSAWATT package.

Features:

- Low saturation voltage
- VERSAWATT package
- Maximum safe-operating-area curves
- Thermal-cycling ratings

TERMINAL DESIGNATIONS



MAXIMUM RATINGS, Absolute-Maximum Values:

	N-P-N	40871	
	P-N-P	40872*	
COLLECTOR-TO-EMITTER SUSTAINING VOLTAGE:	With external base-to-emitter resistance (R_{BE}) = 100 Ω	$V_{CER(sus)}$	120 V
	With base open	$V_{CEO(sus)}$	100 V
EMITTER-TO-BASE VOLTAGE:		V_{EBO}	5 V
COLLECTOR CURRENT (Continuous)		I_C	7 A
BASE CURRENT (Continuous)		I_B	3 A
TRANSISTOR DISSIPATION:		P_T	
At case temperatures up to 25°C			40 W
At ambient temperatures up to 25°C			1.8 W
At case temperatures above 25°C			Derate linearly at 0.32W/°C
At ambient temperatures above 25°C			Derate linearly at 0.0144 W/°C

TEMPERATURE RANGE:

Storage & Operating (Junction) -65 to 150 °C

LEAD TEMPERATURE (During Soldering):

At distance \geq 1/8 in. (3.17 mm) from case for 10 s max. 235 °C

* For p-n-p device, voltage and current values are negative.

ELECTRICAL CHARACTERISTICS, At Case Temperature (T_C) = 25°C, Unless Otherwise Specified

CHARACTERISTIC	SYMBOL	TEST CONDITIONS				LIMITS		UNITS
		VOLTAGE V dc		CURRENT A dc		40871 40872*		
		V_{CE}	V_{BE}	I_C	I_B	MIN.	MAX.	
Collector-Cutoff Current: With external base-to-emitter resistance (R_{BE}) = 100 Ω	I_{CER}	110				-	1	mA
Emitter-Cutoff Current	I_{EBO}		5	0		-	1	mA
Collector-to-Emitter Sustaining Voltage: With base open	$V_{CEO(sus)}$			0.1	0	100	-	V
With external base-to-emitter resistance (R_{BE}) = 100 Ω	$V_{CER(sus)}$			0.1		120	-	V
DC Forward-Current Transfer Ratio	h_{FE}	4		1*		50	250	
Base-to-Emitter Voltage	V_{BE}	4		1*		-	1.5	V
Collector-to-Emitter Saturation Voltage	$V_{CE(sat)}$			1*	0.1	-	1.0	V
Gain-Bandwidth Product	f_T	4		0.5		4	-	MHz
Thermal Resistance:								
Junction-to-Case	$R_{\theta JC}$					-	3.125	°C/W
Junction-to-Ambient	$R_{\theta JA}$						70	

* For p-n-p devices, voltage and current values are negative.
 * Pulsed: Pulse duration = 300 μ s, duty factor = 0.018.

CAUTION: The sustaining voltages $V_{CEO(sus)}$ and $V_{CER(sus)}$ MUST NOT be measured on a curve tracer.

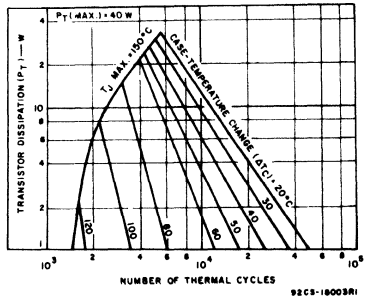


Fig. 1 - Thermal-cycling ratings for both types.

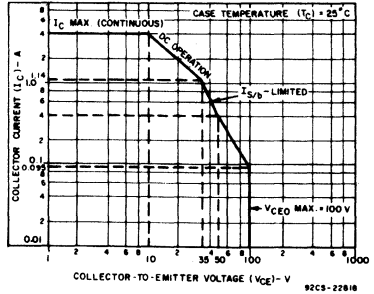


Fig. 2 - Maximum operating areas for 40871.

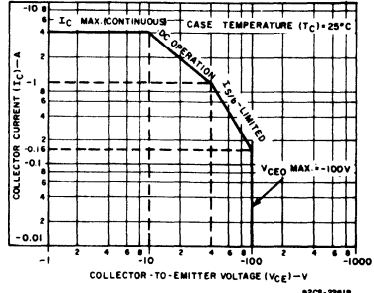


Fig. 3 - Maximum operating areas for 40872.

40871, 40872

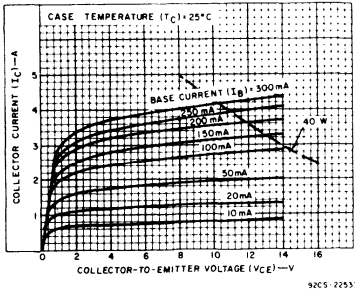


Fig. 4 - Typical output characteristics for 40871.

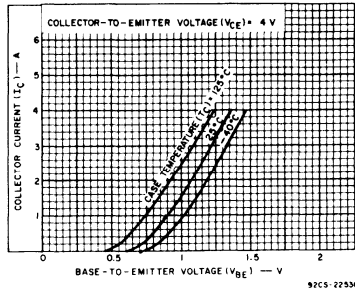


Fig. 5 - Typical transfer characteristics for 40871.

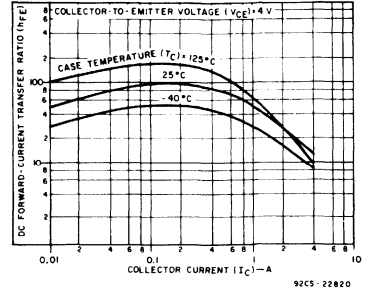


Fig. 6 - Typical dc beta characteristics for 40871.

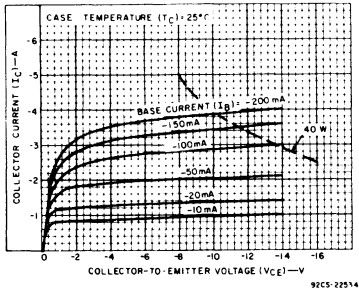


Fig. 7 - Typical output characteristics for 40872.

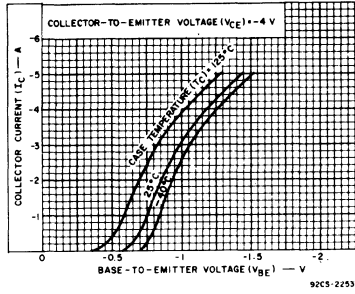


Fig. 8 - Typical transfer characteristics for 40872.

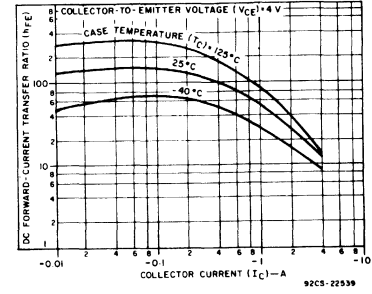


Fig. 9 - Typical dc beta characteristics for 40872.

BD142

Hometaxial-Base, High-Power Silicon N-P-N Transistor

Rugged General-Purpose Device For Commercial Use

The RCA-BD142 is a hometaxial-base diffused-junction silicon n-p-n transistor intended for a wide variety of intermediate-power and high-power applications. It is especially suited for use in audio and inverter circuits at 12 volts.

The BD142 is supplied in a JEDEC TO-3 hermetic steel package.

Applications:

- Series and shunt regulators
- High-fidelity amplifiers
- Power-switching circuits
- Solenoid drivers
- 12-V audio and inverter circuits

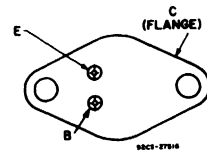
Features:

- Maximum-safe-area-of-operation curves
- Low saturation voltage
- High dissipation rating
- Thermal-cycling rating curve

MAXIMUM RATINGS, Absolute Maximum Values

COLLECTOR-TO-BASE VOLTAGE	V _{CB0}	50	V
COLLECTOR-TO-EMITTER SUSTAINING VOLTAGE:			
With base open	V _{CE0(sus)}	45	V
With base reverse bias V _{BE} = -1.5 V	V _{CEV(sus)}	50	V
EMITTER-TO-BASE VOLTAGE	V _{EBO}	7	V
CONTINUOUS COLLECTOR CURRENT	I _C	15	A
CONTINUOUS BASE CURRENT	I _B	7	A
TRANSISTOR DISSIPATION:	P _T		
At case temperatures up to 25°C		117	W
At case temperatures above 25°C		Derate linearly to 200°C	
TEMPERATURE RANGE:			
Storage and Operating (Junction)		-65 to +200	°C
PIN TEMPERATURE (During Soldering)			
At distances ≥ 1/32 in. (0.8 mm) from seating plane for 10 s max.		235	°C

TERMINAL DESIGNATIONS



JEDEC TO-3

ELECTRICAL CHARACTERISTICS, At Case Temperature (T_C) = 25°C Unless Otherwise Specified.

CHARACTERISTIC	SYMBOL	TEST CONDITIONS				LIMITS		UNITS	
		VOLTAGE V _{dc}			CURRENT A _{dc}		MIN.		MAX.
		V _{CE}	V _{EB}	V _{BE}	I _C	I _B			
Collector Cutoff Current With base-emitter junction reverse-biased	I _{CEV}	40		-1.5			2	mA	
Emitter Cutoff Current	I _{EBO}		7				1	mA	
Collector-to-Emitter Sustaining Voltage									
With base open	V _{CE0(sus)}				0.2	0	45	V	
With base-emitter junction reverse-biased	V _{CEV(sus)}			-1.5	0.1		50	V	
DC Forward Current Transfer Ratio	h _{FE}	4			4 ^a		12.5	160	
Base to Emitter Voltage	V _{BE}	4			4 ^a		1.5	V	
Collector to Emitter Saturation Voltage	V _{CE(sat)}				4 ^a	0.4	1.1	V	
Common Emitter, Small Signal, Short Circuit, Forward Current Transfer Ratio (f = 1 kHz)	h _{fe}	4			1		10	-	
Magnitude of Common-Emitter, Small-Signal, Short-Circuit, Forward Current Transfer Ratio (f = 0.4 MHz)	h _{fe}	4			1		2	-	
Gain Bandwidth Product	f _T				1		800	kHz	
Forward Bias Second-Breakdown Collector Current (t ≥ 1 s)	I _{S/b}	39					3	A	
Thermal Resistance (Junction-to-Case)	R _{θJC}						1.5	°C/W	

^a Pulsed Pulse duration = 300 μs, duty factor = 2%.

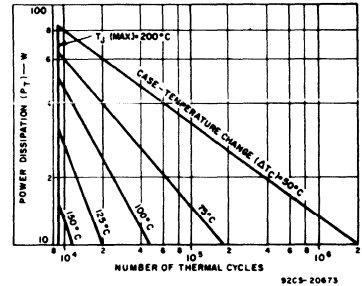


Fig. 1 - Thermal-cycling rating chart.

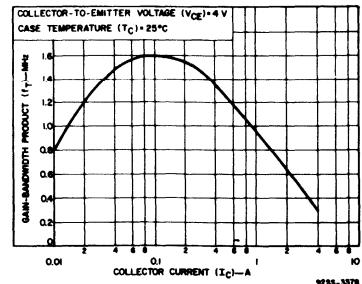


Fig. 2 - Typical gain-bandwidth product.

BD142

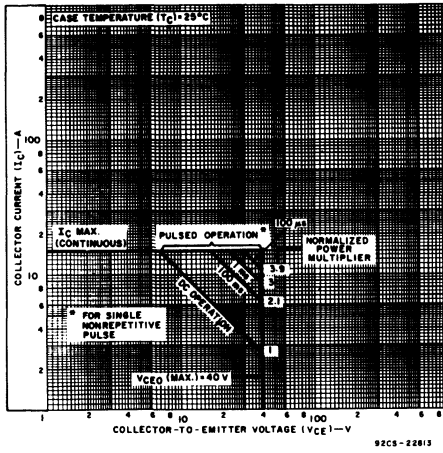


Fig. 3 – Maximum safe area of operation.

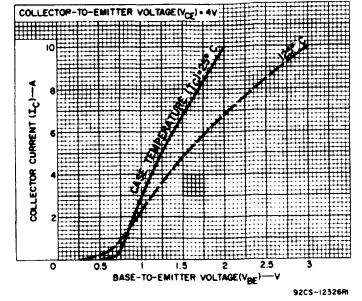


Fig. 4 – Typical transfer characteristics.

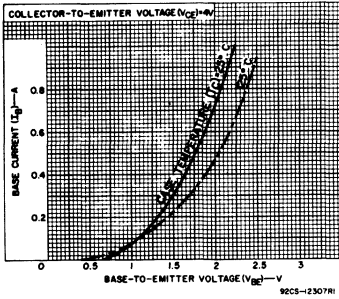


Fig. 5 – Typical input characteristics.

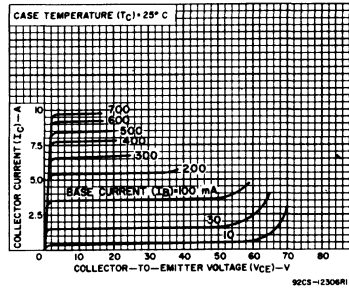


Fig. 6 – Typical output characteristics.

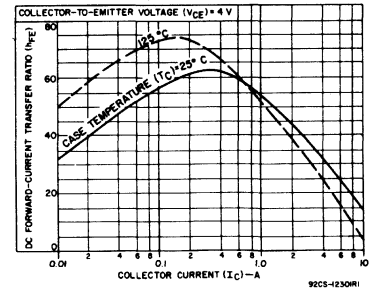


Fig. 7 – Typical dc beta characteristics.

BD181, BD182, BD183

Hometaxial-Base, High Power Silicon N-P-N Transistors

Rugged, Broadly Applicable Devices For Commercial Use

RCA-BD181, BD182 and BD183 are silicon n-p-n transistors intended for a wide variety of high-power applications. The hometaxial-base construction of these devices renders them highly resistant to second breakdown over a wide range of operating conditions.

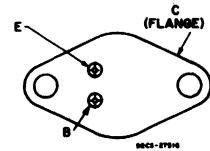
These transistors are supplied in a JEDEC TO-3 hermetic steel package.

Features:

- Maximum safe-area-of-operation curves
- Low saturation voltages
- High dissipation ratings
- Thermal-cycling rating curves

Applications:

- Series and shunt regulators
- High-fidelity amplifiers
- Power-switching circuits
- Solenoid drivers

TERMINAL DESIGNATIONS

MAXIMUM RATINGS, Absolute-Maximum Values:

	BD181	BD182	BD183		
COLLECTOR-TO-BASE VOLTAGE	55	70	85	V	
COLLECTOR-TO-EMITTER SUSTAINING VOLTAGE:					
With external base-to-emitter resistance (R_{BE}) = 100 Ω	$V_{CER(sus)}$	55	70	85	V
With base open	$V_{CEO(sus)}$	45	60	80	V
EMITTER-TO-BASE VOLTAGE	V_{EBO}	7	7	7	V
CONTINUOUS COLLECTOR CURRENT	I_C	15	15	15	A
CONTINUOUS BASE CURRENT	I_B	7	7	7	A
TRANSISTOR DISSIPATION:	P_T				
At case temperatures up to 25°C		117	117	117	W
At case temperatures above 25°C		← See Fig. 2 →			
TEMPERATURE RANGE:					
Storage and Operating (Junction)		← -65 to +200 →			°C
PIN TEMPERATURE (During Soldering):					
At distances \geq 1/32 in. (0.8 mm) from seating plane for 10 s max.		← 235 →			°C

ELECTRICAL CHARACTERISTICS, At Case Temperature (T_C) = 25°C Unless Otherwise Specified

CHARACTERISTIC	SYMBOL	TEST CONDITIONS						LIMITS						UNITS
		VOLTAGE				CUR-		BD181		BD182		BD183		
		V dc						RENT		MIN.		MAX.		
		V_{CB}	V_{CE}	V_{EB}	V_{BE}	I_C	I_B	MIN.	MAX.	MIN.	MAX.	MIN.	MAX.	
Collector-Cutoff Current:	I_{CBO}	45					0	-	2	-	-	-	-	mA
With emitter open and		60					0	-	-	-	5	-	-	
$T_C = 200^\circ\text{C}$		80					0	-	-	-	-	-	5	
With base-emitter junction reverse-biased	I_{CEX}		45		-1.5			-	1	-	-	-	-	
			60		-1.5			-	-	-	1	-	-	
			80		-1.5			-	-	-	-	-	1	
Emitter-Cutoff Current	I_{EBO}			7				-	5	-	5	-	5	mA
Collector-to-Emitter Sustaining Voltage:	$V_{CEO(sus)}$					0.2 ^a	0	45	-	60	-	80	-	V
With external base-to-emitter resistance (R_{BE})=100 Ω		$V_{CER(sus)}$					0.2 ^a		55	-	70	-	85	
DC Forward Current Transfer Ratio	h_{FE}		4			4 ^a		-	-	20	70	-	-	
			4				3 ^a		20	70	-	-	20	
Base-to-Emitter Voltage	V_{BE}		4			3 ^a		-	1.5	-	-	-	1.5	V
			4				4 ^a		-	-	-	1.5	-	
Collector-to-Emitter Saturation Voltage	$V_{CE(sat)}$					4 ^a	0.4 ^a	-	-	-	1	-	-	V
							3 ^a	0.3 ^a	-	1	-	-	-	
Magnitude of Common-Emitter, Small-Signal, Short-Circuit, Forward Current Transfer Ratio ($f = 0.4$ MHz)	$ h_{fe} $		4			1		2	-	2	-	2	-	
Gain-Bandwidth Product	f_T					1		800	-	800	-	800	-	kHz
Common-Emitter, Short-Circuit, Small-Signal, Forward Current Transfer Ratio Cutoff Frequency	f_{hfe}		4			0.3		15	-	15	-	15	-	kHz
Forward-Bias Second Breakdown Collector Current ($t \geq 1$ s)	$I_{S/b}$		30					3.95	-	3.95	-	3.95	-	A
Thermal Resistance (Junction-to-Case)	$R_{\theta JC}$							-	1.5	-	1.5	-	1.5	°C/W

^a Pulsed: Pulse duration = 300 μ s, duty factor = 1.8%.

BD181, BD182, BD183

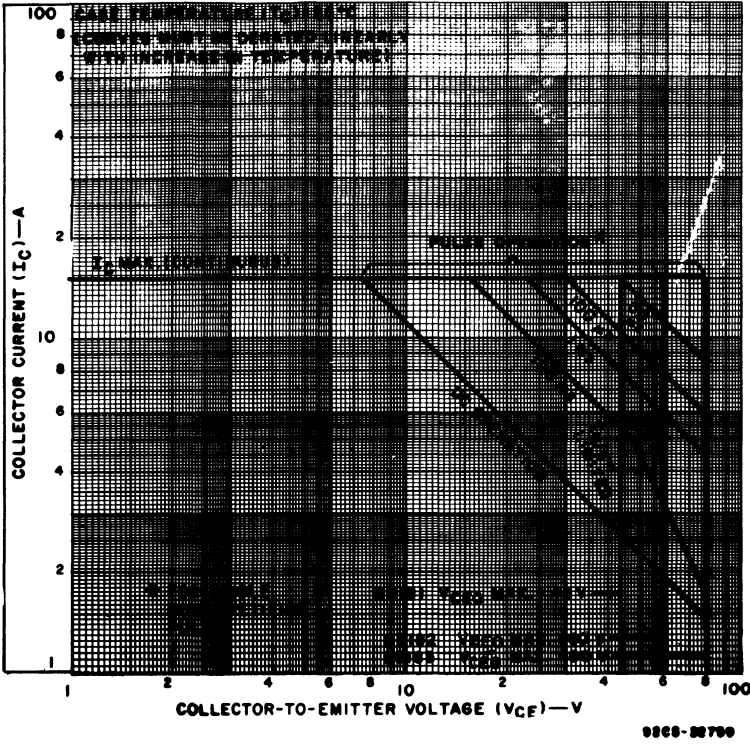


Fig. 1 - Maximum operating areas for all types.

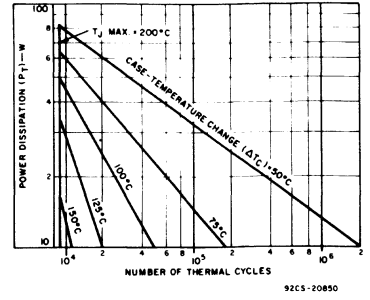


Fig. 2 - Thermal cycling rating chart for all types.

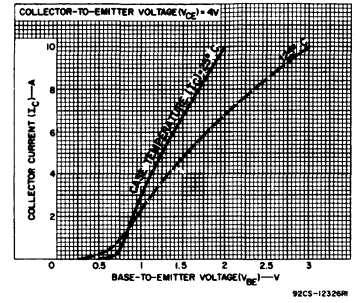


Fig. 3 - Typical transfer characteristics for all types.

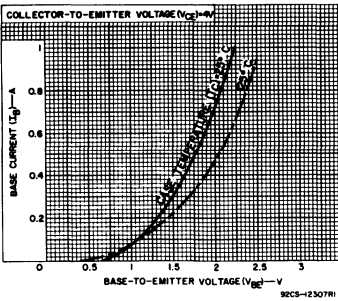


Fig. 4 - Typical input characteristics for BD182.

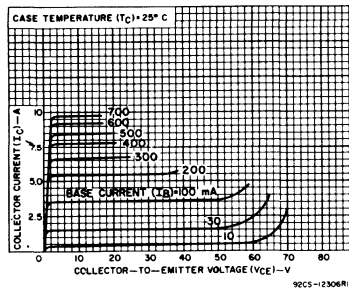


Fig. 5 - Typical output characteristics for BD182.

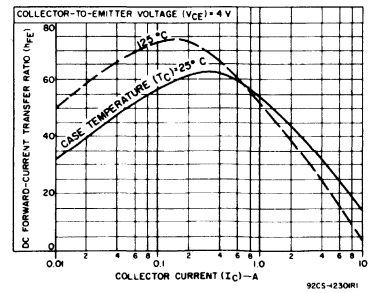


Fig. 6 - Typical dc-beta characteristics for BD182.

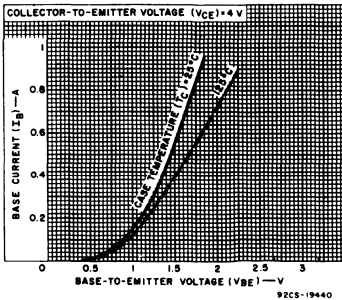


Fig. 7 - Typical input characteristics for BD181 and BD183.

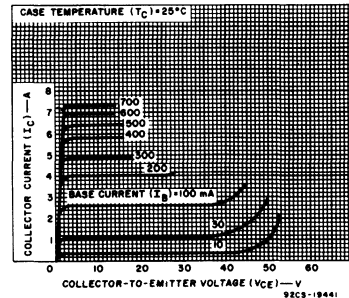


Fig. 8 - Typical output characteristics for BD181 and BD183.

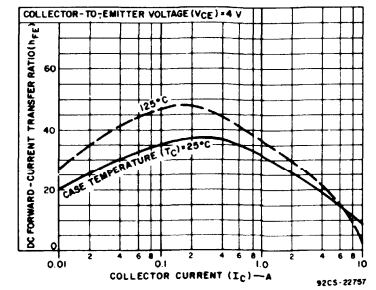


Fig. 9 - Typical dc-beta characteristics for BD181 and BD183.

BD181, BD182, BD183

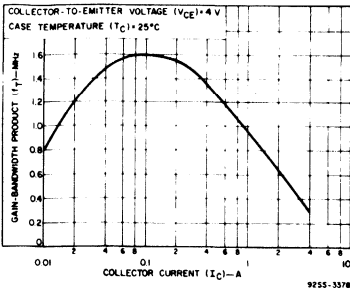


Fig. 10 — Typical gain-bandwidth product for all types.

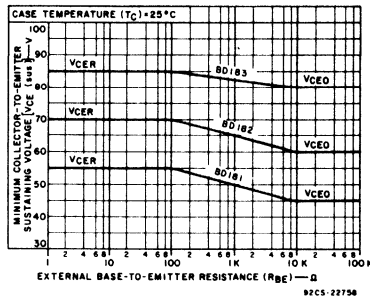


Fig. 11 — Sustaining voltage vs. base-to-emitter resistance for all types.

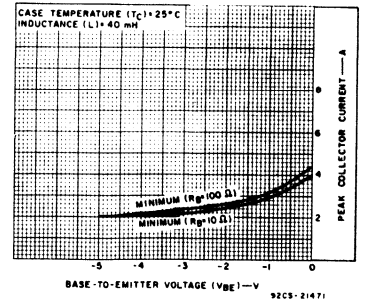


Fig. 12 — Minimum reverse-bias second-breakdown characteristics for all types.

BD239, BD239A, BD239B, BD239C BD240, BD240A, BD240B, BD240C

Epitaxial-Base Silicon N-P-N and P-N-P VERSAWATT Transistors

For Power-Amplifier and High-Speed-Switching Applications

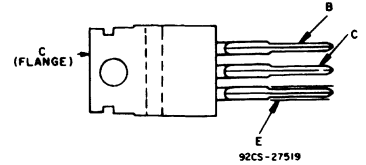
These RCA devices are epitaxial-base silicon n-p-n and p-n-p transistors; they differ only in their voltage ratings. These transistors are intended for a wide variety of switching and amplifier applications such as series and shunt regulators, and driver and output stages of high-fidelity amplifiers. The BD240-series p-n-p power transistors are complements of the n-p-n devices in the BD239 series.

All these transistors are supplied in the JEDEC TO-220AB straight-lead version of the VERSAWATT package. Optional lead configurations are available upon request. For information, contact your nearest RCA International Sales Office.

Features:

- 30 W at 25°C case temperature
- 4-A rated collector current
- Min. f_T of 3 MHz at 10 V, 200 mA

TERMINAL DESIGNATIONS



**BOTTOM VIEW
JEDEC TO-220 AB**

MAXIMUM RATINGS, Absolute-Maximum Values:

	BD239 BD240*	BD239A BD240A*	BD239B BD240B*	BD239C BD240C*	
COLLECTOR-TO-EMITTER VOLTAGE:					
With external base-to-emitter resistance (R_{BE}) = 100 Ω	V_{CER}	55	70	90	115 V
With base open	V_{CEO}	45	60	80	100 V
EMITTER-TO-BASE VOLTAGE	V_{EBO}	5	5	5	5 V
CONTINUOUS COLLECTOR CURRENT	I_C	4	4	4	4 A
CONTINUOUS BASE CURRENT	I_B	1	1	1	1 A
TRANSISTOR DISSIPATION:	P_T				
At case temperatures up to 25°C		30	30	30	30 W
At ambient temperatures up to 25°C		2	2	2	2 W
At case temperatures above 25°C		Derate linearly to 150°C			
TEMPERATURE RANGE:					
Storage & Operating (Junction)		-65 to 150			°C
LEAD TEMPERATURE (During Soldering):					
At distance 1/8 in. (3.17 mm) from case for 10 s max.		235			°C

* For p-n-p devices, voltage and current values are negative.

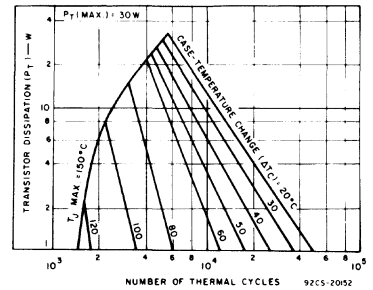


Fig. 1 - Thermal-cycling ratings for all types.

ELECTRICAL CHARACTERISTICS at Case Temperature (T_C) = 25°C

CHARACTERISTIC	SYMBOL	TEST CONDITIONS ∇				LIMITS								UNITS
		VOLTAGE V dc		CURRENT A dc		BD239 BD240*		BD239A BD240A*		BD239B BD240B*		BD239C BD240C*		
		V_{CE}	V_{BE}	I_C	I_B	MIN.	MAX.	MIN.	MAX.	MIN.	MAX.	MIN.	MAX.	
Collector Cutoff Current: With base open	I_{CEO}	-30			0	-	-0.3	-	-0.3	-	-	-	-	
		-60			0	-	-	-	-	-	-0.3	-	0.3	mA
With base-to-emitter junction short-circuited	I_{CES}	-45	0		-	-	-0.2	-	-	-	-	-	-	
		-60	0		-	-	-	-	-	-	-	-	-	
Emitter Cutoff Current	I_{EBO}	-80	0		-	-	-	-	-	-	-0.2	-	-0.2	
		-100	0		-	-	-	-	-	-	-	-	-0.2	
Collector-to-Emitter Breakdown Voltage: With base open	$V_{BR(CEO)}$			0.03 ^a	0	-45	-	-60	-	-80	-	-100	-	V
DC Forward-Current Transfer Ratio	h_{FE}	-4		-0.2 ^a		40	-	40	-	40	-	40	-	
		-4		-1 ^a		15	-	15	-	15	-	15	-	
Base-to-Emitter Voltage	V_{BE}	-4		-1 ^a		-	-	-1.3	-	-1.3	-	-1.3	-	V
Collector-to-Emitter Saturation Voltage	$V_{CE(sat)}$			-1 ^a	-0.2	-	-	-0.7	-	-0.7	-	-0.7	-	V
Common-Emitter Small-Signal Short- Circuit Forward- Current Transfer Ratio ($f = 1$ kHz)	h_{fe}	-10		0.2		20	-	20	-	20	-	20	-	
Magnitude of Common Emitter Small-Signal Short-Circuit Forward- Current Transfer Ratio ($f = 1$ MHz)	$ h_{fe} $	-10		0.2		3	-	3	-	3	-	3	-	
Thermal Resistance Junction-to-Case	$R_{\theta JC}$					-	4.17	-	4.17	-	4.17	-	4.17	°C/W
Junction-to-Ambient	$R_{\theta JA}$					-	62.5	-	62.5	-	62.5	-	62.5	

* For p-n-p devices, voltage and current values are negative.

^aPulsed Pulse duration = 300 μ s, duty factor = 2%.

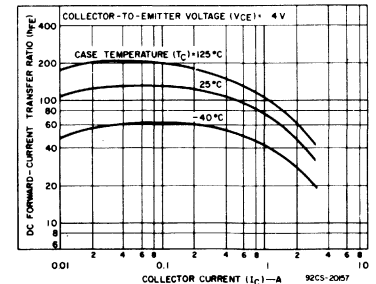


Fig. 2 - Typical dc beta characteristics for BD239-series types.

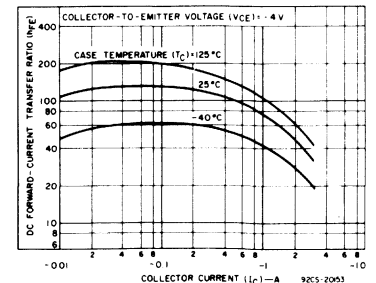


Fig. 3 - Typical dc beta characteristics for BD240-series types.

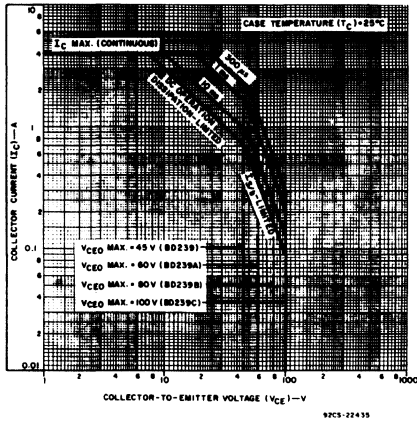
BD239, BD239A, BD239B, BD239C, BD240, BD240A, BD240B, BD240C


Fig. 4 – Maximum safe operating areas for BD239-series types.

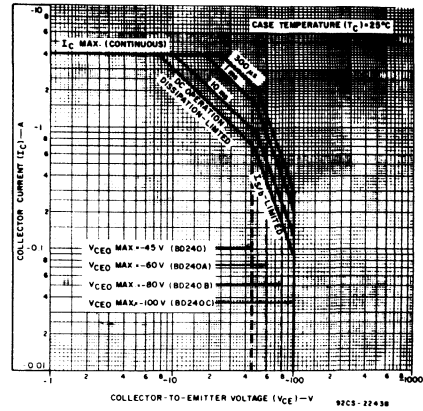


Fig. 5 – Maximum safe operating areas for BD240-series types.

BD241, BD241A, BD241B, BD241C, BD242, BD242A, BD242B, BD242C

Epitaxial-Base Silicon N-P-N and P-N-P VERSAWATT Transistors

For Power-Amplifier and High-Speed-Switching Applications

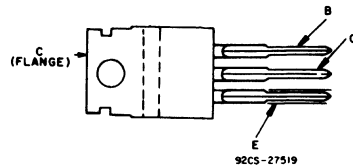
These RCA devices are epitaxial-base silicon n-p-n and p-n-p transistors; they differ only in their voltage ratings. These transistors are intended for a wide variety of switching and amplifier applications such as series and shunt regulators, and driver and output stages of high-fidelity amplifiers. The BD242-series p-n-p power transistors are complements of the n-p-n devices in the BD241 series.

All these transistors are supplied in the JEDEC TO-220AB straight lead version of the VERSAWATT package. Optional lead configurations are available upon request. For information, contact your nearest RCA International Sales Office.

Features:

- 40 W at 25°C case temperature
- 5-A rated collector current
- Min. f_T of 3 MHz at 10 V, 500 mA

TERMINAL DESIGNATIONS



BOTTOM VIEW
JEDEC TO-220 AB

MAXIMUM RATINGS, Absolute-Maximum Values:

COLLECTOR-TO-EMITTER VOLTAGE:

With external base-to-emitter resistance (R_{BE}) = 100 Ω V_{CER}
 With base open V_{CEO}
EMITTER-TO-BASE VOLTAGE V_{EBO}
CONTINUOUS COLLECTOR CURRENT I_C
CONTINUOUS BASE CURRENT I_B
TRANSISTOR DISSIPATION: P_T
 At case temperatures up to 25°C
 At ambient temperatures up to 25°C
 At case temperatures above 25°C

	BD241 BD242*	BD241A BD242A*	BD241B BD242B*	BD241C BD242C*	
V_{CER}	55	70	90	115	V
V_{CEO}	45	60	80	100	V
V_{EBO}	5	5	5	5	V
I_C	5	5	5	5	A
I_B	1	1	1	1	A
P_T	40	40	40	40	W
	2	2	2	2	W
		Derate linearly to 150°C			

TEMPERATURE RANGE:

Storage & Operating (Junction) \leftarrow -65 to 150 \rightarrow °C
LEAD TEMPERATURE (During Soldering):
 At distance 1/8 in. (3.17 mm) from case for 10 s max. \leftarrow 235 \rightarrow °C

* For p-n-p devices, voltage and current values are negative.

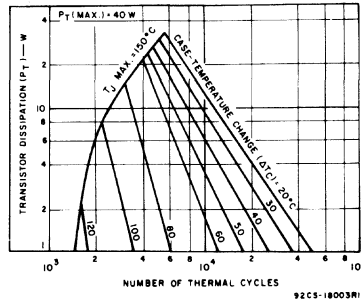


Fig. 1 - Thermal-cycling ratings for all types.

ELECTRICAL CHARACTERISTICS at Case Temperature (T_C) = 25°C

CHARACTERISTIC	SYMBOL	TEST CONDITIONS				LIMITS								UNITS
		VOLTAGE		CURRENT		BD241 BD242*		BD241A BD242A*		BD241B BD242B*		BD241C BD242C*		
		V_{CE}	V_{BE}	I_C	I_B	MIN.	MAX.	MIN.	MAX.	MIN.	MAX.	MIN.	MAX.	
Collector Cutoff Current: With base open	I_{CEO}	30			0	-	0.3	-	0.3	-	-	-	-	mA
		60			0	-	-	-	-	-	0.3	-	0.3	
		45	0		-	-	0.2	-	-	-	-	-	-	
With base-to-emitter junction short-circuited	I_{CES}	60	0		-	-	-	-	0.2	-	-	-	-	mA
		80	0		-	-	-	-	-	-	0.2	-	-	
		100	0		-	-	-	-	-	-	-	-	0.2	
Emitter Cutoff Current	I_{EBO}		-5	0	-	1	-	1	-	1	-	1	mA	
Collector-to-Emitter Breakdown Voltage: With base open	$V_{BR(ICE)}$			0.03 ^a	0	45	-	60	-	80	-	100	-	V
DC Forward-Current Transfer Ratio	h_{FE}	4		1 ^a		25	-	25	-	25	-	25	-	
		4		3 ^a		10	-	10	-	10	-	10	-	
Base-to-Emitter Voltage	V_{BE}	4		3 ^a		-	1.8	-	1.8	-	1.8	-	1.8	V
Collector-to-Emitter Saturation Voltage	$V_{CE(sat)}$			3 ^a	0.6	-	1.2	-	1.2	-	1.2	-	1.2	V
Common-Emitter Small-Signal Short-Circuit Forward-Current Transfer Ratio ($f = 1$ kHz)	h_{fe}	10		0.5		20	-	20	-	20	-	20	-	
		10		0.5		3	-	3	-	3	-	3	-	
Thermal Resistance	$R_{\theta JC}$					-	3.125	-	3.125	-	3.125	-	3.125	°C/W
						-	62.5	-	62.5	-	62.5	-	62.5	

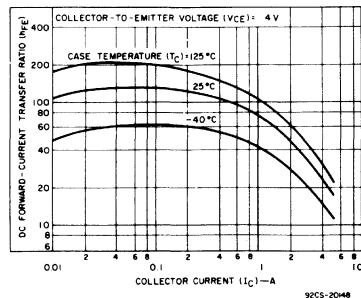


Fig. 2 - Typical dc beta characteristics for BD241-series types.

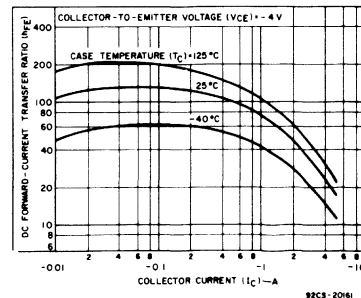


Fig. 3 - Typical dc beta characteristics for BD242-series types.

BD241, BD241A, BD241B, BD241C, BD242, BD242A, BD242B, BD242C

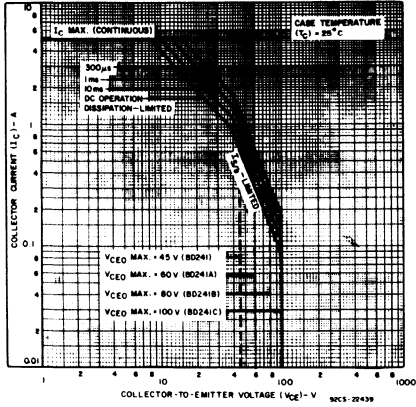


Fig. 4 – Maximum safe operating areas for BD241-series types.

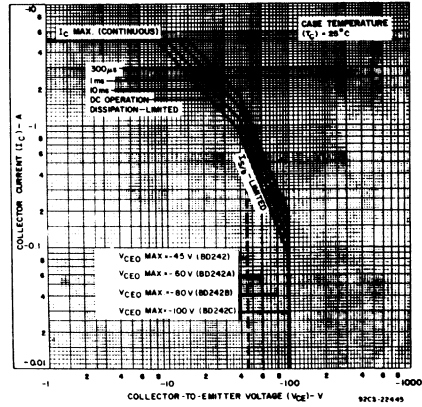


Fig. 5 – Maximum safe operating areas for BD242-series types.

BD243, BD243A, BD243B, BD243C, BD244, BD244A, BD244B, BD244C

Epitaxial-Base Silicon N-P-N and P-N-P VERSAWATT Transistors

For Power Amplifier and High Speed-Switching Applications

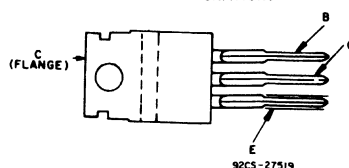
These RCA devices are epitaxial-base silicon n-p-n and p-n-p transistors; they differ only in their voltage ratings. These transistors are intended for a wide variety of switching and amplifier applications such as series and shunt regulators, and driver and output stages of high-fidelity amplifiers. The BD244-series p-n-p power transistors are complements of the n-p-n devices in the BD243 series.

All these transistors are supplied in the JEDEC TO-220AB straight-lead version of the VERSAWATT package. Optional lead configurations are available upon request. For information, contact your nearest RCA International Sales Office.

Features:

- 65 W at 25°C case temperature
- 7-A rated collector current
- Min. f_T of 3 MHz at 10 V, 500 mA

TERMINAL DESIGNATIONS



**BOTTOM VIEW
JEDEC TO-220 AB**

MAXIMUM RATINGS, Absolute-Maximum Values:

	BD243 BD244*	BD243A BD244A*	BD243B BD244B*	BD243C BD244C*		
COLLECTOR-TO-EMITTER VOLTAGE With external base to emitter resistance (R_{BE}) = 100 Ω	V_{CE} 55	70	90	115	V	
With base open.....	V_{CEO} 45	60	80	100	V	
EMITTER-TO-BASE VOLTAGE	V_{EBO} 5	5	5	5	V	
CONTINUOUS COLLECTOR CURRENT	I_C 6.5	6.5	6.5	6.5	A	
CONTINUOUS BASE CURRENT	I_B 1	1	1	1	A	
TRANSISTOR DISSIPATION: At case temperatures up to 25°C.....	P_T 65	65	65	65	W	
At ambient temperatures up to 25°C.....	2	2	2	2	W	
At case temperatures above 25°C.....	Derate linearly to 150°C					
TEMPERATURE RANGE: Storage & Operating (Junction).....	-65 to 150					°C
LEAD TEMPERATURE (During Soldering): At distance 1/8 in. (3.17 mm) from case for 10 s max.	235					°C

* For p-n-p devices, voltage and current values are negative.

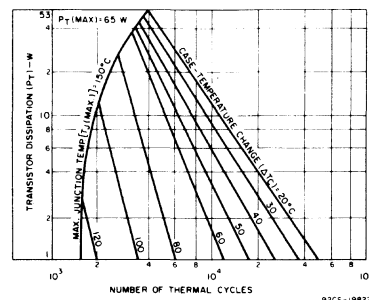


Fig. 1 - Thermal-cycling ratings for all types.

ELECTRICAL CHARACTERISTICS at Case Temperature (T_C) = 25°C

CHARACTERISTIC	SYMBOL	TEST CONDITIONS*				LIMITS								UNITS
		VOLTAGE V dc		CURRENT A dc		BD243 BD244*		BD243A BD244A*		BD243B BD244B*		BD243C BD244C*		
		V_{CE}	V_{BE}	I_C	I_B	MIN.	MAX.	MIN.	MAX.	MIN.	MAX.	MIN.	MAX.	
Collector Cutoff Current: With base open	I_{CEO}	30	60	0	0	-	0.7	-	0.7	-	-	-	0.7	mA
With base-to-emitter junction short-circuited	I_{CES}	45	60	0	0	-	0.4	-	0.4	-	-	-	0.4	mA
Emitter Cutoff Current	I_{EBO}	-5	0	0	0	-	1	-	1	-	1	-	1	mA
Collector-to-Emitter Breakdown Voltage: With base open	$V_{BR}(CEO)$			0.03 ^a	0	45	-	60	-	80	-	100	-	V
DC Forward-Current Transfer Ratio	h_{FE}	4	4	0.3 ^a	3 ^a	30	-	30	-	30	-	30	-	
Base-to-Emitter Voltage	V_{BE}	4	4	6 ^a	6 ^a	-	2	-	2	-	2	-	2	V
Collector-to-Emitter Saturation Voltage	$V_{CE}(sat)$			6 ^a	1	-	1.5	-	1.5	-	1.5	-	1.5	V
Common-Emitter Small-Signal Short-Circuit Forward-Current Transfer Ratio ($f = 1$ kHz)	h_{fe}	10	10	0.5	0.5	20	-	20	-	20	-	20	-	
Magnitude of Common Emitter Small-Signal Short-Circuit Forward-Current Transfer Ratio ($f = 1$ MHz)	$ h_{fe} $	10	10	0.5	0.5	3	-	3	-	3	-	3	-	
Thermal Resistance Junction-to-Case	$R_{\theta JC}$					-	1.92	-	1.92	-	1.92	-	1.92	°C/W
Junction-to-Ambient	$R_{\theta JA}$					-	62.5	-	62.5	-	62.5	-	62.5	°C/W

* Pulsed: Pulse duration = 300 μ s, duty factor = 2%

* For p-n-p devices, voltage and current values are negative.

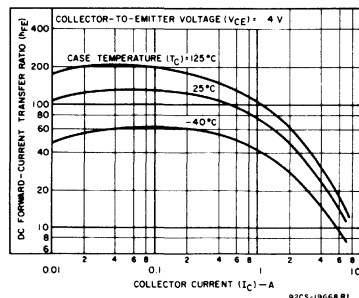


Fig. 2 - Typical dc beta characteristics for BD243-series types.

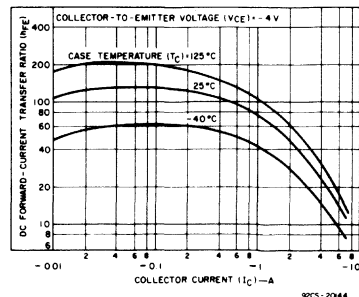


Fig. 3 - Typical dc beta characteristics for BD244-series types.

BD243, BD243A, BD243B, BD243C, BD244, BD244A, BD244B, BD244C

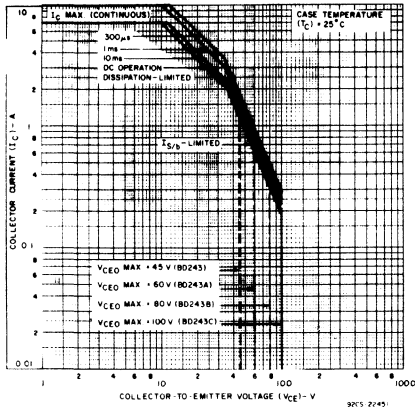


Fig. 4 – Maximum safe operating areas for BD243-series types.

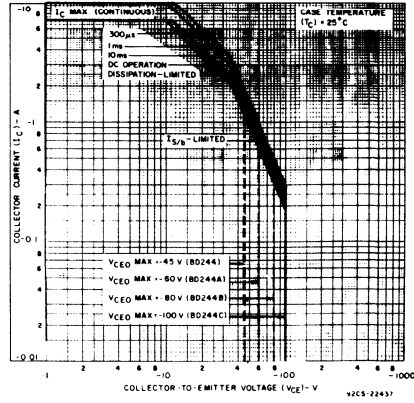


Fig. 5 – Maximum safe operating areas for BD244-series types.

BD277

7-A, 70-W, Epitaxial-Base, Silicon P-N-P VERSAWATT Transistor

For Applications in Series and Shunt Regulators

Type BD277 is an epitaxial-base silicon p-n-p transistor supplied in the JEDEC TO-220AB straight-lead VERSAWATT package. It is also available in the TO-220AA package (leads formed to fit a TO-66 socket); to order this version, specify formed lead No. 6201.

The BD277 is useful in series regulators and shunt regulators because of its low saturation voltage and high power-dissipation capability. It is also useful as a replacement for germanium p-n-p transistors in many applications.

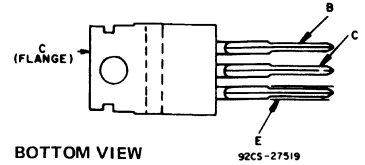
Features:

- Thermal-cycling ratings
- Maximum-safe-area-of-operation curve
- Low saturation voltage
- VERSAWATT package (molded silicone plastic)
- High power-dissipation capability

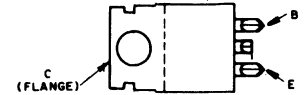
MAXIMUM RATINGS, Absolute-Maximum Values:

COLLECTOR-TO-BASE VOLTAGE:			
With emitter open	V _{CB0}	-45	V
COLLECTOR-TO-EMITTER VOLTAGE:			
With base open	V _{CEO}	-45	V
EMITTER-TO-BASE VOLTAGE:			
With collector open	V _{EBO}	-4	V
Collector Current (Continuous)	I _C	-7	A
Base Current (Continuous)	I _B	-3	A
TRANSISTOR DISSIPATION:			
At case temperatures up to 25°C	P _T	70	W
At case temperatures above 25°C			
Derate linearly at 0.56 W/°C			
TEMPERATURE RANGE:			
Storage & Operating (Junction)		-65 to 150	°C
LEAD TEMPERATURE (During Soldering):			
At distance ≥ 1/8 in. (3.17 mm) from case for 10 s max.		235	°C

TERMINAL DESIGNATIONS



TO-220AB



TO-220AA

ELECTRICAL CHARACTERISTICS, At Case Temperature (T_C) = 25°C unless specified otherwise

CHARACTERISTIC	SYMBOL	TEST CONDITIONS					LIMITS		UNITS	
		VOLTAGE			CURRENT			MIN.		MAX.
		V _{CE}	V _{CB}	V _{EB}	I _C	I _B	I _E			
Collector Cutoff Current:	I _{CBO}								mA	
With emitter open		-45			0			-0.1		
With emitter open and T _C = 150°C		-40			0			-2.0		
With base open	I _{CEO}	-30			0			-1.0		
Emitter Cutoff Current:	I _{EBO}			-4	0			-1.0	mA	
Collector-to-Emitter Breakdown Voltage:	V(BR)CEO				-0.1*	0		-45	V	
With base open										
Base-to-Emitter Voltage	V _{BE}	-2			-1.75*			-1.2	V	
DC Forward-Current Transfer Ratio	h _{FE}	-2			-1.75*		30	150		
Collector-to-Emitter Saturation Voltage	V _{CE(sat)}				-1.75*	-0.1		-0.5	V	
Gain-Bandwidth Product	f _T	-4			-0.5		10		MHz	
Thermal Resistance:										
Junction-to-Case	R _{θJC}							1.78	°C/W	
Junction-to-Ambient	R _{θJA}							70		

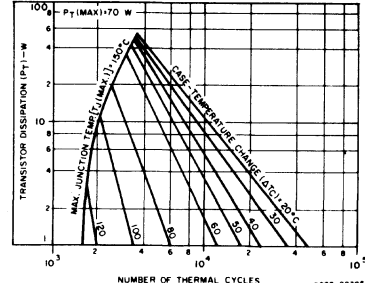


Fig. 1 - Thermal-cycling ratings.

* Pulsed: Pulse duration = 300 μs, duty factor ≤ 2%.

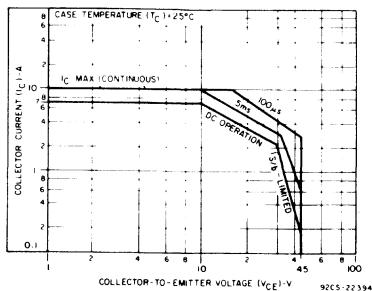


Fig. 2 - Maximum operating area.

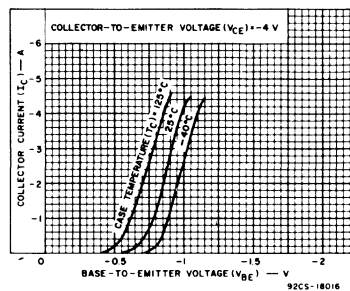


Fig. 3 - Typical transfer characteristics.

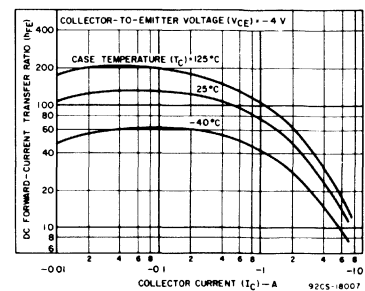


Fig. 4 - Typical dc beta characteristics.

BD278, BD278A

High-Current, Silicon N-P-N VERSAWATT Transistors

For Medium-Power Linear and Switching Service in Consumer, Automotive, and Industrial Applications

The RCA BD278 and BD278A are homotaxial-base silicon n-p-n transistors supplied in the JEDEC TO-220AB straight-lead VERSAWATT package. They are also available in the TO-220AA package (leads formed to fit a TO-66 socket), to order this version, specify formed lead No. 6201.

These transistors are intended for a wide variety of medium-power switching and linear applications such as series regulators, solenoid drivers, motor-speed controls, inverters, output stages for high-fidelity amplifiers, and power supply and vertical-deflection circuits for monochrome and color TV.

Features:

- Low saturation voltage: $V_{CE(sat)} = 1 \text{ V max. at } I_C = 4 \text{ A}$
- VERSAWATT package (molded-silicon plastic)
- Maximum-safe-area-of-operation curve
- Thermal-cycling rating curve

MAXIMUM RATINGS, Absolute-Maximum Values:

	BD278	BD278A		
COLLECTOR-TO-BASE VOLTAGE	V_{CB0}	55	70	V
COLLECTOR-TO-EMITTER SUSTAINING VOLTAGE:				
With external base-to-emitter resistance (R_{BE}) = 100Ω	$V_{CER(sus)}$	55	70	V
With base open	$V_{CEO(sus)}$	45	60	V
EMITTER-TO-BASE VOLTAGE	V_{EBO}	5	5	V
COLLECTOR CURRENT (Continuous)	I_C	10	10	A
BASE CURRENT	I_B	4	4	A
TRANSISTOR DISSIPATION:	P_T			
At case temperature: up to 25°C		75	75	W
At ambient temperatures up to 25°C		1.8	1.8	W
At case temperatures above 25°C, derate linearly		0.6	0.6	W/°C
At ambient temperatures above 25°C, derate linearly		0.0144	0.0144	W/°C
TEMPERATURE RANGE:				
Storage & Operating (Junction)			-65 to 150	°C
LEAD TEMPERATURE (During Soldering):				
At distance $\geq 1/8$ in. (3.17 mm) from case for 10 s max.			235	°C

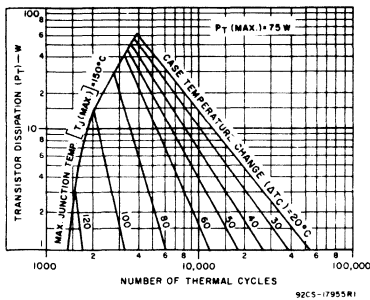
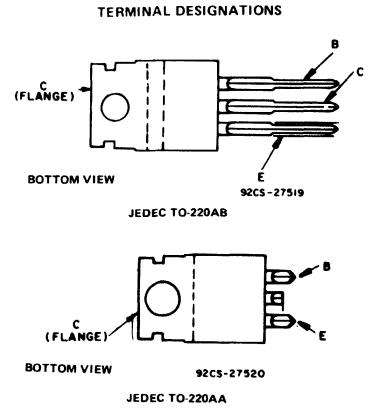


Fig. 1 - Thermal-cycling ratings.

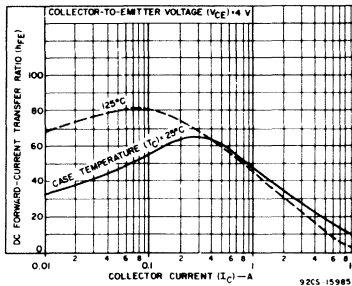


Fig. 2 - Typical dc beta characteristics.

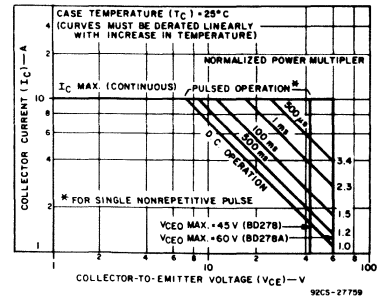


Fig. 3 - Maximum safe operating area.

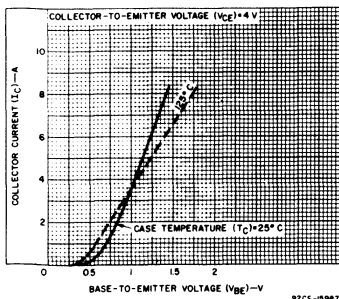


Fig. 4 - Typical transfer characteristics.

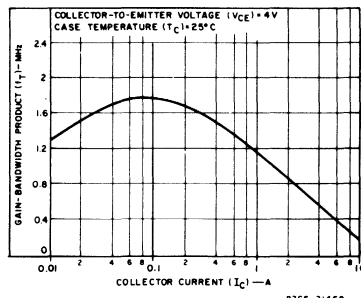


Fig. 5 - Typical gain bandwidth product.

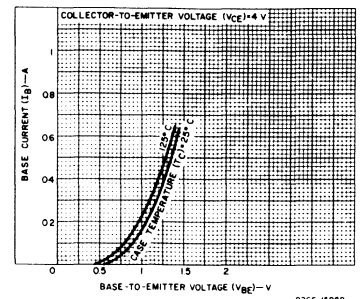


Fig. 6 - Typical input characteristics.

BD278, BD278A

ELECTRICAL CHARACTERISTICS, at Case Temperature (T_C) = 25°C unless otherwise specified

CHARACTERISTIC	SYMBOL	TEST CONDITIONS				LIMITS				UNITS
		VOLTAGE V _{dc}		CURRENT A _{dc}		BD278		BD278A		
		V _{CE}	V _{EB}	I _C	I _B	MIN.	MAX.	MIN.	MAX.	
Collector Cutoff Current: With base-to-emitter junction reverse-biased	I _{CEX}	55	1.5			—	2	—	—	mA
With base-to-emitter junction reverse-biased and T _C = 150°C		70	1.5			—	—	—	2	
With base open	I _{CEO}	30			0	—	2	—	—	mA
		45			0	—	—	—	2	
Emitter Cutoff Current	I _{EBO}		5			—	5	—	5	mA
Collector-to-Emitter Sustaining Voltage: With external base-to-emitter resistance (R _{BE}) = 100Ω ^a	V _{CER(sus)}			0.2		55	—	70	—	V
With base open ^a	V _{CEO(sus)}			0.2	0	45	—	60	—	
DC Forward-Current Transfer Ratio ^a	h _{FE}	4		4		15	75	15	75	
Base-to-Emitter Voltage ^a	V _{BE}	4		4		—	1.8	—	1.8	V
Collector-to-Emitter Saturation Voltage ^a	V _{CE(sat)}			4	0.4	—	1	—	1	V
Common-Emitter Small-Signal Short-Circuit Forward-Current Transfer Ratio (f = 1 kHz)	h _{fe}	4		0.5		15	—	15	—	
Magnitude of Common-Emitter Small-Signal Short-Circuit Forward-Current Transfer Ratio (f = 0.1 MHz)	h _{fe}	4		0.5		8	28	8	28	
Forward-Bias Second-Breakdown Collector Current (t = 0.5 s)	I _{S/b}	40				1.87	—	1.87	—	A
Thermal Resistance: Junction-to-Case	R _{θJC}					—	1.67	—	1.67	°C/W
Junction-to-Ambient	R _{θJA}					—	70	—	70	

^a Pulsed, pulse duration = 300μs, duty factor = 0.018

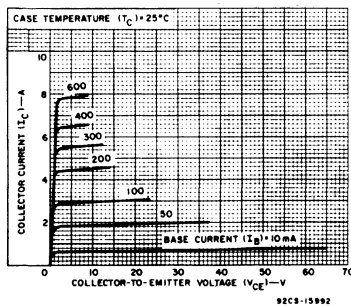


Fig. 7 – Typical output characteristics.

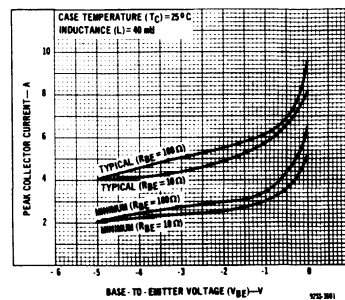


Fig. 8 – Reverse-bias second-breakdown characteristics.

BD450, BD451

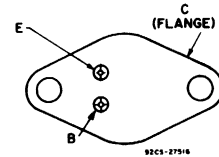
Silicon Transistors for 70-Watt Quasi-Complementary-Symmetry Audio Amplifiers with Hometaxial-Base Output Transistors

The RCA-BD450 and BD451 are n-p-n hometaxial-base silicon transistors particularly suitable for output stages of audio amplifiers. The BD451 is intended for 70-W amplifiers with 8-ohm loads and will also deliver 38 W with 16-ohm loads. The BD450 is intended for 70-W amplifiers with 4-ohm loads. The 70-W amplifier shown in Figs. 2 and 5 uses two BD451 in conjunction

with seven TO-39 case transistors, eleven diodes, and an 84-volt split power supply. The amplifier output is directly coupled to an 8-ohm speaker. This amplifier is especially suitable for instrumentation applications where ruggedness is essential.

The BD450 and BD451 are supplied in the JEDEC TO-204MA (formerly TO-3) hermetic steel case.

TERMINAL DESIGNATIONS



JEDEC TO-204MA

MAXIMUM RATINGS, Absolute-Maximum Values :

	BD450	BD451	
V _{CB0}	80	95	V
V _{CEO}	50	60	V
V _{CER} (R _{BE} = 100 Ω)	80	95	V
V _{EB0}	—	—	V
I _C	—	15	V
I _B	—	7	A
P _T :			
At T _C < 25°C	—	115	W
At T _C > 25°C	—	See Fig. 1	—
T _{stg} , T _J	—	—	- 65 to 200 °C
T _L :			
At distance ≥ 1/32 in. (0.8 mm) from seating plane for 10 s max.	—	230	°C

TYPICAL PERFORMANCE DATA For 70-Watt Audio Amplifier

Measured at a line voltage of 220 V, T_A = 25°C, and a frequency of 1 kHz, unless otherwise specified.

Power:	IM Distortion:
Rated power (8-Ω load, at rated distortion) 70 W	10 dB below continuous power output at 60 Hz and 7 kHz (4:1) 0.1%
Typical power (4-Ω load) 70 W	
Typical power (16-Ω load) 38 W	Sensitivity:
Music power (8-Ω load, at 5% THD with regulated supply) 100 W	At continuous power-output rating 700 mV
Dynamic power (8-Ω load, at 1% THD with regulated supply) 88 W	Hum and Noise:
Total Harmonic Distortion:	Below continuous power output:
Rated distortion 1.0%	Input shorted 85 dB
	Input open 80 dB
	Input Resistance 20 kΩ

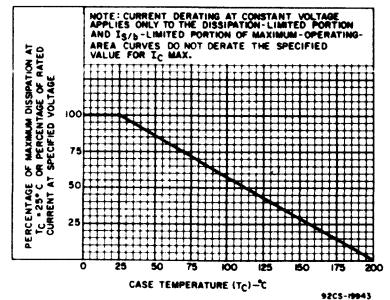


Fig. 1 - Derating curve.

With 60-volt split power supply and 2-BD450 substituted for 2-BD451.

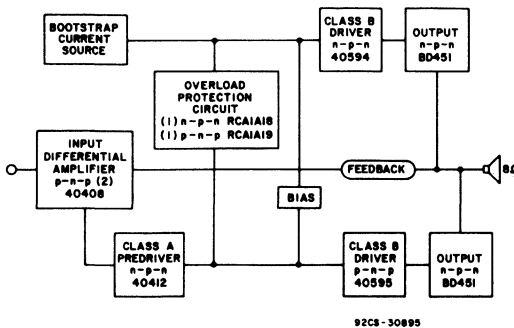


Fig. 2 - Block diagram and transistor complement for 70 watt quasi-complementary-symmetry audio amplifier with hometaxial-base output transistors.

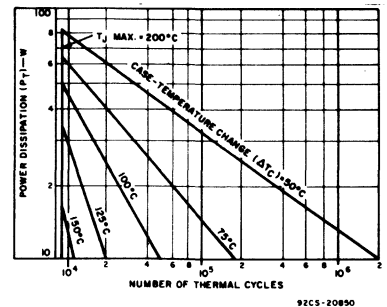


Fig. 3 - Thermal-cycling ratings.

BD450, BD451

ELECTRICAL CHARACTERISTICS, At Case Temperature (T_C) = 25°C

CHARACTERISTIC	TEST CONDITIONS	LIMITS				UNITS
		BD450▲		BD451▲		
		Min.	Max.	Min.	Max.	
I_{CER}	$V_{CE} = 70\text{ V}, R_{BE} = 100\Omega$ $V_{CE} = 85\text{ V}, R_{BE} = 100\Omega$	—	0.5	—	—	mA
I_{EBO}	$V_{EB} = 4\text{ V}, I_C = 0$	—	1	—	1	mA
V_{CER}	$I_C = 0.2\text{ A}, R_{BE} = 100\Omega$	80	—	95	—	V
f_T	$I_C = 1\text{ A}, V_{CE} = 4\text{ V}$	0.8	—	0.8	—	MHz
h_{FE}	$I_C = 4\text{ A}, V_{CE} = 4\text{ V}$ $I_C = 6\text{ A}, V_{CE} = 4\text{ V}$	—	—	20	70	
$V_{CE(sat)}$	$I_C = 4\text{ A}, I_B = 0.4\text{ A}$ $I_C = 6\text{ A}, I_B = 0.6\text{ A}$	—	—	1	—	V
V_{BE}	$I_C = 4\text{ A}, V_{CE} = 4\text{ V}$ $I_C = 6\text{ A}, V_{CE} = 4\text{ V}$	—	1.4	—	—	V
$I_{S/b}$	$V_{CE} = 50\text{ V}, t = 1\text{ s}$ $V_{CE} = 60\text{ V}, t = 1\text{ s}$	2.3	—	—	1.95	A

▲For characteristics curves and test conditions, refer to published data for prototype 2N3055 (Hometaxial), File 1077.

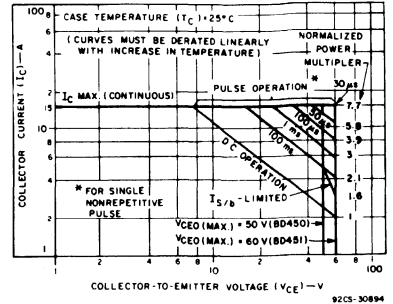


Fig. 4 - Maximum operating areas.

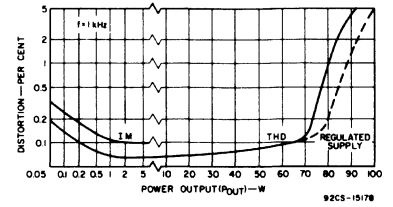


Fig. 6 - Typical intermodulation and total harmonic distortion as a function of power output at 1 kHz for 70-W amplifier.

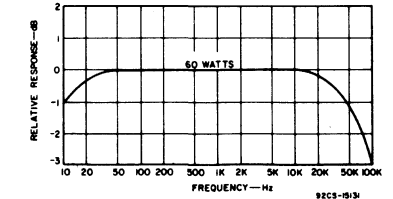
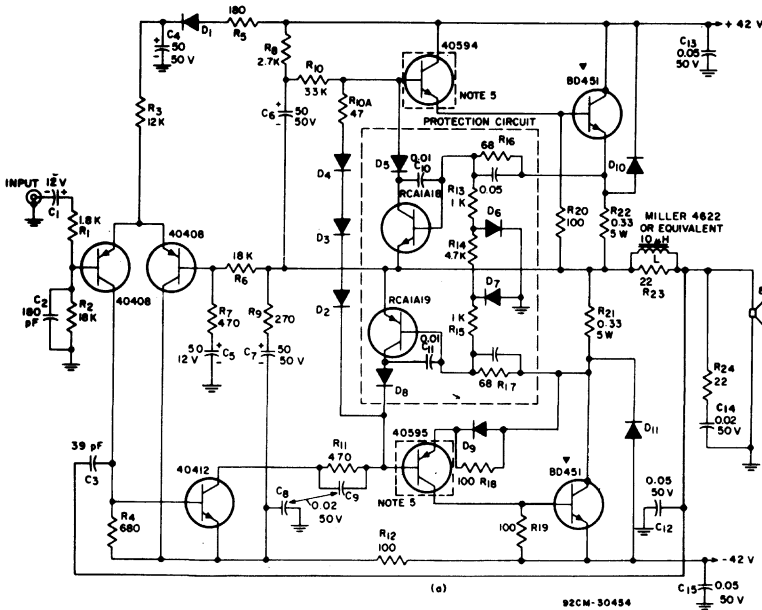


Fig. 7 - Typical response as a function of frequency at 60-W output for the 70-W amplifier.



NOTES:

1. D1-D11—D1201A.
2. Resistors are 1/2-watt, ±10%, unless otherwise specified; values are in ohms.
3. Non-inductive resistors.
4. Capacitances are in μF unless otherwise specified.
5. Mount each device on TO-39 heat sink.
6. Provide heat sink of approx. 1.2°C/W per output device, with contact thermal resistance of 0.5°C/W max. and $T_A = 45^\circ\text{C}$ max.

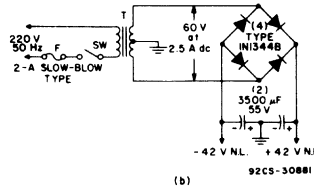


Fig. 5 - 70-watt amplifier circuit featuring quasi-complementary-symmetry output employing hometaxial-base construction output transistors: (a) basic amplifier circuit, (b) power supply circuit.

BD500, BD501 Series

Silicon Transistors for 40-Watt Full-Complementary-Symmetry Audio Amplifiers

The BD500-Series and BD501-Series types are p-n-p and n-p-n epitaxial-base silicon transistors, respectively, especially suitable for audio-output applications. The 40-watt amplifier shown in Figs. 1 and 5 uses the BD500B and BD501B in conjunction with seven TO-39 transistors, ten diodes, and a 64-volt split power supply. The amplifier output is directly

coupled to an 8-ohm speaker. The BD500A and BD501A are intended for similar 40-watt audio amplifiers except for a 4-ohm speaker and a split 46-volt power supply. The BD500 and BD501 are intended for 25-watt audio amplifiers of similar circuitry except for a 4-ohm speaker and a split 40-volt power supply.

MAXIMUM RATINGS, Absolute-Maximum Values:

	BD501 BD500*	BD501A BD500A*	BD501B BD500B*	N-P-N P-N-P
V _{CB0}	60	70	90	V
V _{CEO}	50	60	80	V
V _{CE(RBE = 100 Ω)}	55	65	85	V
V _{EBO}	_____	5	_____	V
I _C	_____	10	_____	A
I _B	_____	4	_____	A
P _T :				
At T _C ≤ 25°C	_____	75	_____	W
At T _C > 25°C	_____	See Figs. 2 and 4	_____	
T _{stg} , T _J	_____	-65 to 150	_____	°C
T _L :				
At distances ≥ 1/32 in. (0.8 mm) from case for 10 s max.	_____	230	_____	°C

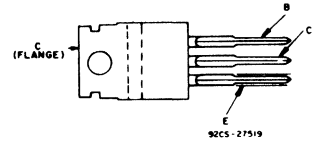
* For p-n-p devices, voltage and current values are negative.

**TYPICAL PERFORMANCE DATA
For 40-Watt Audio Amplifier**

Measured at a line voltage of 220 V, T_A = 25°C, and a frequency of 1 kHz, unless otherwise specified.

- Power:**
- Rated power (8-Ω load, at rated distortion) 40 W
 - Typical power (4-Ω load) 75 W ■
 - Typical power (16-Ω load) 22 W
- Total Harmonic Distortion:**
- Rated distortion 1.0%
 - Typical at 20 W 0.05%
- IM Distortion:**
- 10 dB below continuous power output at 60 Hz and 7 kHz (4:1) 0.1%
- Typical power (4Ω load) with 46-volt split power supply and BD500A, BD501A output 40 W**
Typical power (4Ω load) with 40-volt split power supply and BD500, BD501 output 25W
- IHF Power Bandwidth:**
- 3 dB below rated continuous power at rated distortion 80 kHz
- Sensitivity:**
- At continuous power-output rating 600 mV
- Hum and Noise:**
- Below continuous power output:
 - Input shorted 80 dB
 - Input open 75 dB
 - Input Resistance 20 kΩ

TERMINAL DESIGNATIONS



BOTTOM VIEW

JEDEC TO-220AB

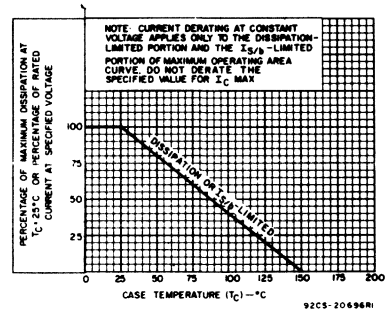


Fig. 2 - Derating curve for all types.

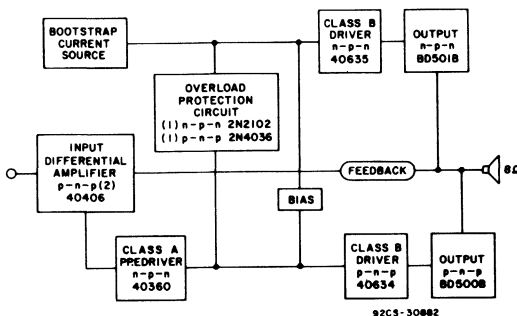


Fig. 1 - Block diagram and transistor complement for 40-watt full-complementary-symmetry audio amplifier.

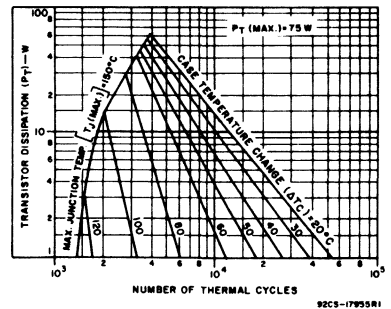


Fig. 3 - Thermal-cycling ratings.

BD500, BD501 Series

ELECTRICAL CHARACTERISTICS, At Case Temperature (T_C) = 25°C

CHARACTERISTICS	TEST CONDITIONS	LIMITS [▲]						UNITS	
		BD500* BD501		BD500A* BD501A		BD500B* BD501B			
		Min.	Max.	Min.	Max.	Min.	Max.		
I_{CER} $R_{BE} = 100 \Omega$	$V_{CE} = 45 V$ $V_{CE} = 55 V$ $V_{CE} = 75 V$	—	1	—	—	—	—	—	mA
I_{EBO}	$V_{EB} = 5 V$	—	1	—	1	—	1	—	mA
V_{CEO}	$I_C = 0.1 A$	50	—	60	—	80	—	—	V
V_{CER}	$I_C = 0.1 A; R_{BE} = 100 \Omega$	55	—	65	—	85	—	—	V
f_T	$I_C = 0.5 A; V_{CE} = 4 V$	5	—	5	—	5	—	—	MHz
h_{FE}	$I_C = 5 A; V_{CE} = 4 V$ $I_C = 3.5 A; V_{CE} = 4 V$	15	90	15	90	—	20	120	—
$V_{CE(sat)}$	$I_C = 5 A; I_B = 0.5 A$ $I_C = 3.5 A; I_B = 0.35 A$	—	1.2	—	1.2	—	—	1	V
V_{BE}	$I_C = 5 A; V_{CE} = 4 V$ $I_C = 3.5 A; V_{CE} = 4 V$	—	1.8	—	1.8	—	—	1.5	V
$I_{S/b}$	$V_{CE} = 20 V; t = 0.55 s$ $V_{CE} = 25 V; t = 0.55 s$ $V_{CE} = 30 V; t = 0.55 s$	3.75	—	—	—	—	—	—	A

▲For characteristics curves and test conditions, refer to published data for prototypes (File 678): 2N6487 (BD501, BD501A); 2N6488 (BD501B); 2N6490 (BD500, BD500A); 2N6491 (BD500B).
 *For p-n-p devices, voltage and current values are negative.

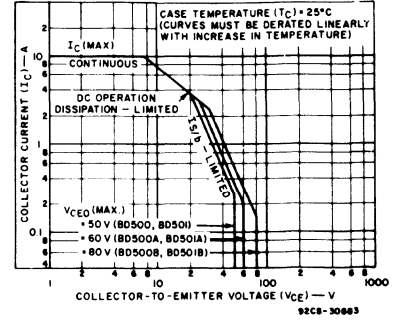


Fig. 4 - Maximum operating areas for all types.

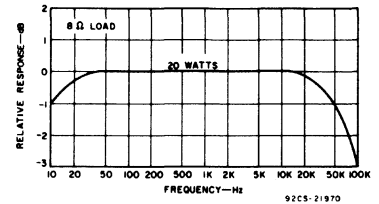


Fig. 6 - Typical frequency response.

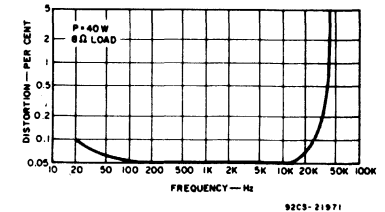
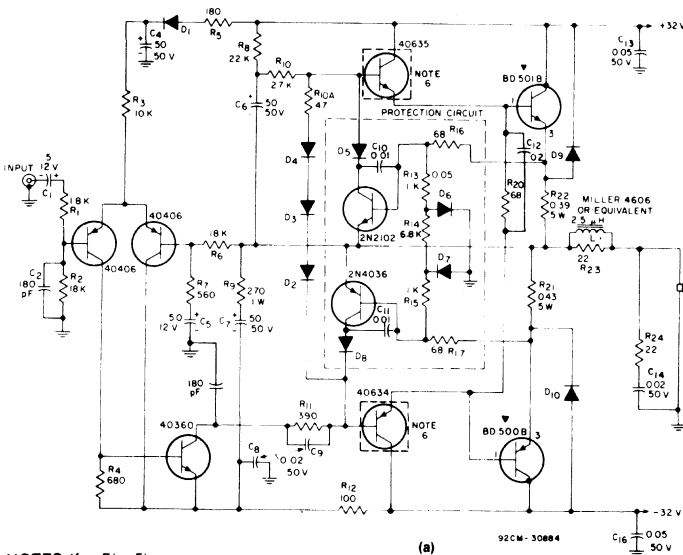
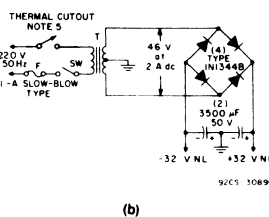


Fig. 7 - Typical total harmonic distortion as a function of frequency.



NOTES (for Fig. 5):

1. D1-D10—D1201A.
2. Resistors are 1/2-watt, ± 10%, unless otherwise specified; values are in ohms.
3. Non-inductive resistors.
4. Capacitances are in μF unless otherwise specified.
5. 55°C thermal cutout attached to heat sink of output devices.
6. TO-39 case devices with heat radiator attached.
7. Provide heat sink of approx. 1.2°C/W per output device with a contact thermal resistance of 1.3°C/W max. and $T_A = 40^\circ C$ max.



(b)

Fig. 5 - 40-watt amplifier circuit featuring full-complementary-symmetry output using load line limiting: (a) basic amplifier circuit, (b) power-supply circuit.

BD550 Series

Silicon Transistors for 70-, 120-, 200-, and 300-W Quasi-Complementary-Symmetry Audio Amplifiers

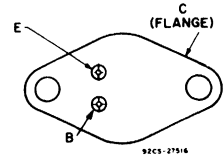
The RCA-BD550, BD550A, and BD550B are silicon n-p-n transistors especially suitable for applications in audio-amplifier circuits, in which they may be used as either driver or output unit.

These devices, together with a variety of other transistors that serve as input devices, V_{BE} amplifiers for biasing, current sources, load-line limiters (for overload protection), and predrivers, may be used to develop

several hundred watts of audio output power in quasi-complementary-symmetry audio amplifier configurations that employ parallel output transistors. Circuit examples, a recommended complement of transistors, and performance data are shown for 70-, 120-, 200-, and 300-W amplifiers.

The BD-550-series is supplied in the JEDEC TO-204MA hermetic steel case.

TERMINAL DESIGNATIONS



JEDEC TO-204MA

MAXIMUM RATINGS, Absolute-Maximum Values:

	BD550	BD550A	BD550B	
V_{CBO}	130	200	275	V
V_{CEO}	110	175	250	V
$V_{CER}(R_{BE} = 100 \Omega)$	130	200	275	V
V_{EBO}	5	5	5	V
I_C	7	7	7	A
I_B	2	2	2	A
P_T				W
At $T_C \leq 25^\circ C$	150	150	150	
At $T_C > 25^\circ C$	See Fig. 1			
T_{stg}, T_J	-65 to 200			$^\circ C$
T_L	230			$^\circ C$

At distance $\geq 1/32$ in. (0.8 mm) from seating plane for 10 s max.

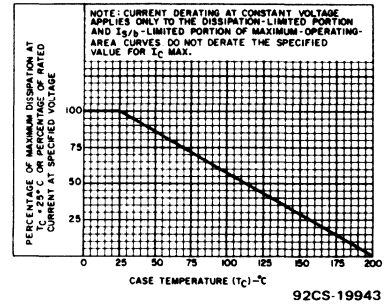


Fig. 1 - Derating curve for all types.

ELECTRICAL CHARACTERISTICS, At Case Temperature (T_C) = 25°C

CHARACTERISTIC	TEST CONDITIONS	LIMITS						UNITS
		BD550A		BD550A*		BD550B*		
		Min.	Max.	Min.	Max.	Min.	Max.	
I_{CER} $R_{BE} = 100 \Omega$	$V_{CE} = 110 V$ $V_{CE} = 175 V$ $V_{CE} = 250 V$	-	1	-	-	-	-	mA
I_{CEO}	$V_{CE} = 95 V$ $V_{CE} = 150 V$ $V_{CE} = 200 V$	-	5	-	5	-	5	mA
I_{EBO}	$V_{EB} = 5 V$	-	1	-	1	-	1	mA
V_{CEO}	$I_C = 0.2 A$	110	-	175	-	250	-	V
V_{CER}	$I_C = 0.2 A; R_{BE} = 100 \Omega$	130	-	200	-	275	-	V
f_T	$I_C = 0.2 A; V_{CE} = 10 V$	5 typ.		5 typ.		5 typ.		MHz
h_{FE}	$I_C = 4 A; V_{CE} = 4 V$ $I_C = 2 A; V_{CE} = 4 V$	15	75	-	-	-	-	
$V_{CE(sat)}$	$I_C = 4 A; I_B = 0.5 A$ $I_C = 2 A; I_B = 0.25 A$	-	2	-	-	-	2	V
V_{BE}	$I_C = 4 A; V_{CE} = 4 V$ $I_C = 2 A; V_{CE} = 4 V$	0.75	1.75	-	-	-	-	V
IS/b	$V_{CE} = 80 V; t = 1 S$ $V_{CE} = 100 V; t = 1 S$ $V_{CE} = 140 V; t = 1 S$	1.87	-	1.5	-	1.07	-	A

* For characteristics curves and test conditions, refer to published data for prototype RCA8638D (File 1060).
 * For characteristics curves and test conditions, refer to published data for prototype 2N5240 (File 321).

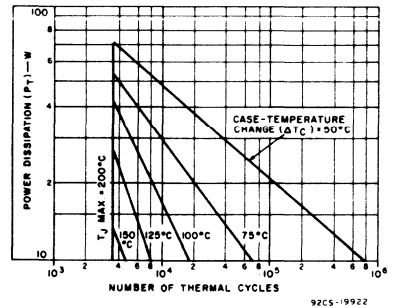


Fig. 2 - Thermal-cycling ratings for all types.

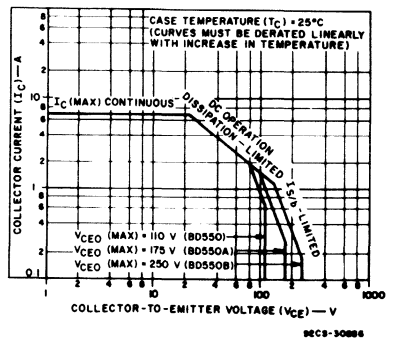


Fig. 3 - Maximum operating areas for all types.

BD550 Series

70-Watt Amplifier

The 70-watt amplifier shown in Figs. 4 and 5 uses two BD550 transistors as output devices, and operates on a 90-volt split power

supply. It is designed for direct coupling to an 8 ohm load. Figs. 6 and 7 show typical distortion characteristics for the amplifier.

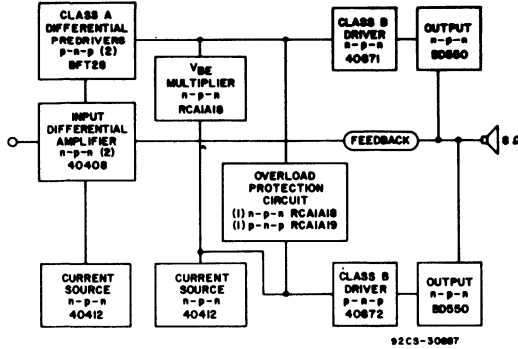
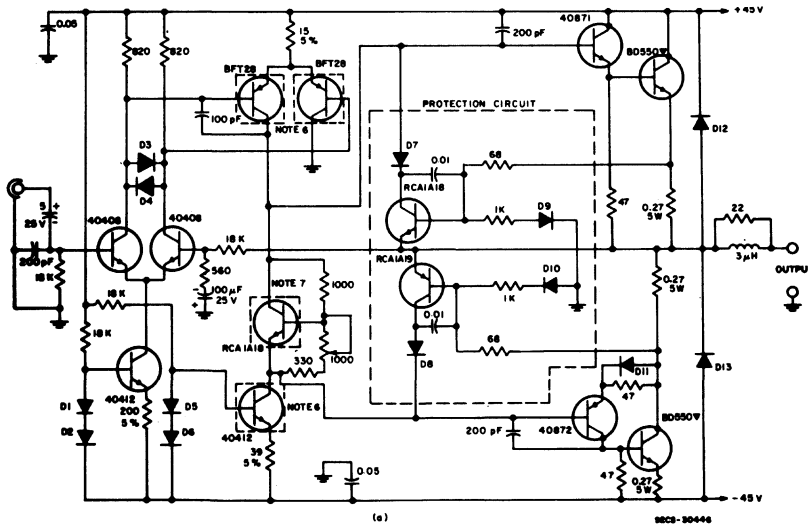


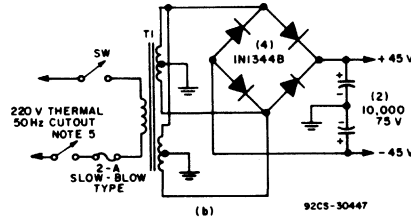
Fig. 4 - Block diagram and transistor complement for 70-watt quasi-complementary-symmetry audio amplifier with epitaxial-base output transistors.



- NOTES:
1. D1-D8, D11-1N5391, D9, D10, D12, D13-1N5393
 2. Resistors are 1/2-watt, ±10%, unless otherwise specified; values are in ohms.
 3. Non-inductive resistors.
 4. Capacitors are in μF unless otherwise specified
 5. 80°C thermal cutout attached to heat sink of output devices.
 6. Mount each device on TO-39 heat sink.
 7. Attach TO-39 heat sink cap to device and mount on same heat sink with the output devices.
 8. Provide heat sink of approx. 1°C/W per output device with a contact thermal resistance of 0.5°C/W max. and T_A = 45°C max.

92CM-30446

Fig. 5 - 70-watt amplifier circuit featuring quasi-complementary-symmetry output employing epitaxial-base construction output transistors: (a) basic amplifier circuit, (b) power-supply circuit.



92CS-30447

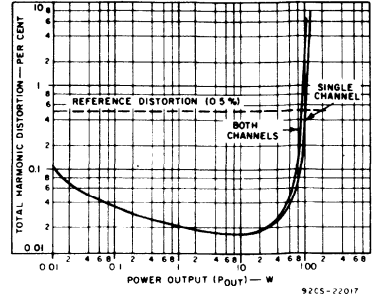


Fig. 6 - Typical total harmonic distortion as a function of power output at 1 kHz, for the 70-watt amplifier.

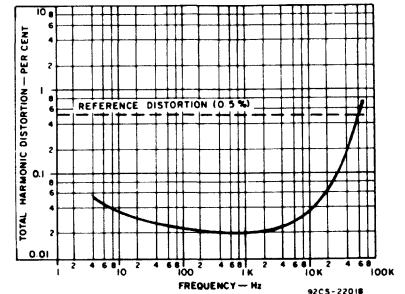


Fig. 7 - Typical total harmonic distortion as a function of frequency at 35 W, for the 70-watt amplifier.

Typical Performance Data for 70-W Audio Amplifier

Measured at a line voltage of 220 V, T_A = 25°C, and a frequency of 1 kHz, unless otherwise specified.

Power:

- Rated power (8-Ω load, at rated distortion) 70 W
- Typical power (16-Ω load) 40 W

Total Harmonic Distortion:

- Rated distortion 0.5 %

IM Distortion:

- 10 dB below continuous power output at 60 Hz and 7 kHz (4:1) <0.2%

IHF Power Bandwidth:

- 3 dB below rated continuous power at rated distortion 5 Hz to 50 kHz
- Bandwidth at 1 W 5 Hz to 100 kHz

Sensitivity:

- At continuous power-output rating 600 mV

Hum and Noise:

- Below continuous power output:
 - Input shorted 100 dB
 - Input open 85 dB
 - With 2 kΩ resistance on 20-ft. cable on input 97 dB
- Input Resistance 18 kΩ

BD550 Series

Typical Performance Data for 200-W Audio Amplifier

Measured at a line voltage of 220 V, $T_A = 25^\circ\text{C}$, and a frequency of 1 kHz, unless otherwise specified.

Power:	
Rated power (8- Ω load, at rated distortion)	200 W
Typical power (4- Ω load)	200 W*
Typical power (16- Ω load)	120 W
Total Harmonic Distortion:	
Rated distortion	0.5%
IM Distortion:	
10 dB below continuous power output at 60 Hz and 7 kHz (4:1)	0.2%
Sensitivity:	
At continuous power output rating	900 mV
Input Resistance	18 k Ω
IHF Power Bandwidth:	
3 dB below rated continuous power at rated distortion	5 Hz to 35 kHz
Hum and Noise:	
Below continuous power output:	
Input shorted	96 dB
Input open	84 dB
With 2 k Ω resistance on 20-ft cable on input	94 dB

* With a 110-V split power supply and 8-BD550A substituted for 8-BD550B.

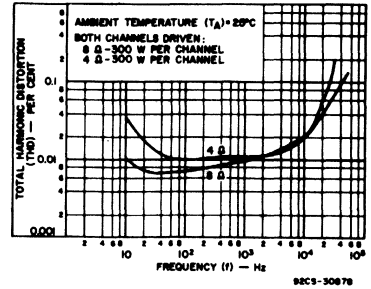


Fig. 17 - Typical total harmonic distortion as a function of frequency for 300-W amplifier.

300-Watt Amplifier

The 300-watt amplifier shown in Figs. 16 and 19 uses two BD550B transistors as drivers and sixteen BD550B transistors as parallel units in the amplifier output stages,

and operates on a 172-volt split power supply. It is intended for direct coupling to an 8 ohm load, but may be used on 4 ohm or 16 ohm loads as shown in the typical performance data (Figs. 17, 18, 20, and 21).

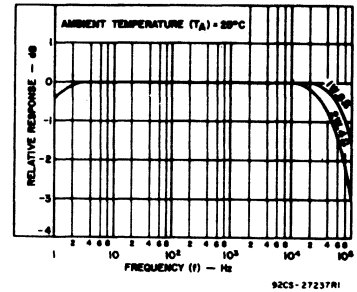
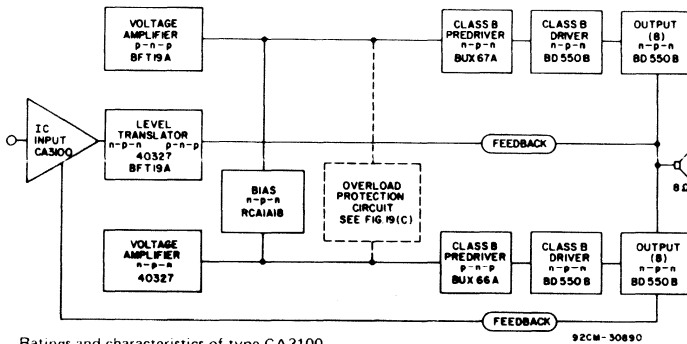


Fig. 18 - Typical frequency response for 300-W amplifier.



Ratings and characteristics of type CA3100 are given in RCA data bulletin File No. 625.

Fig. 16 - Block diagram and transistor complement for 300-W quasi-complementary-symmetry audio amplifier with parallel output transistors.

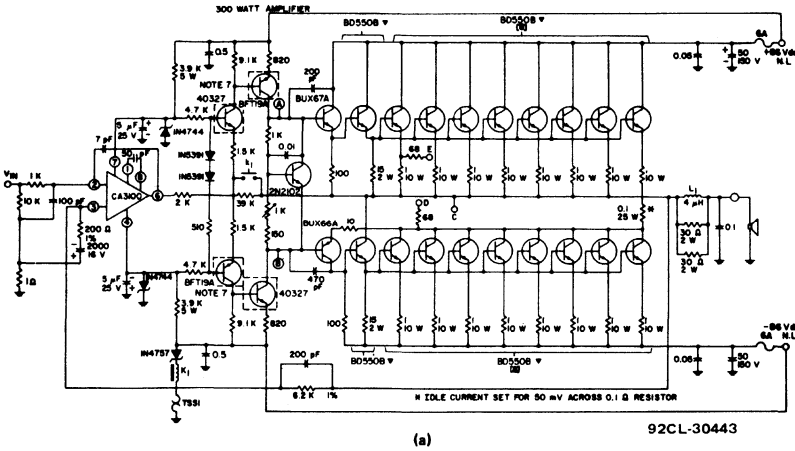
Typical Performance Data for 300-W Audio Amplifier

Measured at a line voltage of 220 V, $T_A = 25^\circ\text{C}$, and a frequency of 1 kHz, unless otherwise specified.

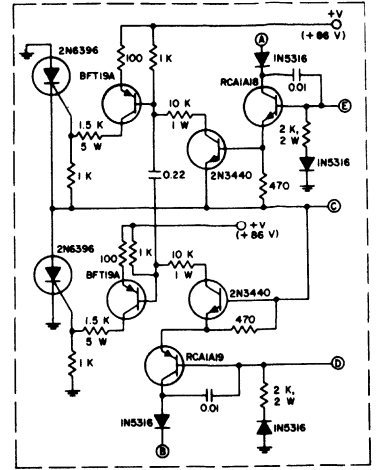
Rated Power (8- Ω load at rated distortion)	300 W
Typical power (4- Ω load)	300 W*
Typical power (16- Ω load)	160 W
Total Harmonic Distortion (THD)	See Figs. 17 and 21
Intermodulation Distortion (IMD)	See Fig. 20
Sensitivity	1.6 V for 300 W
Input Impedance	10 k Ω
Hum and Noise:	
Below rated power output:	
Open input	104 dB
Shorted input	112 dB
Phase Shift	+1° at 20 Hz, -13° at 20 kHz
Slew Rate	35 V/ μs
Rise Time	2.5 μs
Damping Factor	200

* With 120 V split power supply and 18-BD550A substituted for 18-BD550B.

BD550 Series



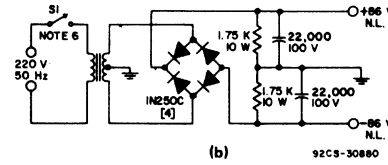
(a)



(c)

NOTES:

1. Resistors are 1/2-watt, $\pm 5\%$ carbon, unless otherwise specified; values are in ohms.
2. Non-inductive resistors.
3. Capacitances are in μF unless otherwise specified.
4. K1 - Relay, single-pole, single-throw, normally closed, with 24-V, 3 mA coil.
5. TSS1 - 70°C thermal cutout attached to heat sink for output devices.
6. S1 - 10-A circuit breaker.
7. Common heat sink - 175 cm^2 minimum.
8. Provide heat sink of approx. 1 C/W per output device with a contact thermal resistance of 0.5 C/W max. and $T_A = 45\text{ C}$ max.



(b)

92CL-30443

Fig. 19 - 300-W audio amplifier circuit featuring quasi-complementary symmetry with parallel output transistors: (a) basic amplifier circuit, (b) power-supply circuit, and (c) protection circuit.

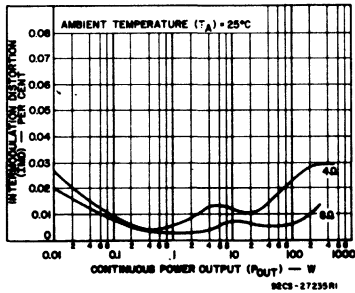


Fig. 20 - Typical intermodulation distortion as a function of power at 60 Hz and 7 kHz with both channels driven for 300-W amplifier.

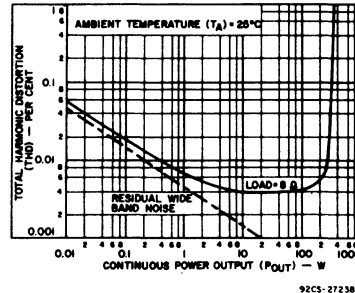


Fig. 21 - Typical total harmonic distortion as a function of power at 1 kHz, both channels driven, for 300-W amplifier.

BDX33, BDX33A, BDX33B, BDX33C, BDX33D, BDX34, BDX34A, BDX34B, BDX34C

10-Ampere N-P-N and P-N-P Darlington Power Transistors

40-60-80-100-120 Volts, 70 Watts

Gain of 750 at 4 A (BDX33, BDX33A, BDX34, BDX34A)

Gain of 750 at 3 A (BDX33B, BDX33C, BDX33D, BDX34B, BDX34C)

These RCA devices are monolithic silicon n-p-n and p-n-p Darlington transistors designed for low- and medium-frequency power applications. The high gain of these devices makes it possible for them to be driven directly from integrated circuits. The BDX33, BDX33A, BDX33B, and BDX33C n-p-n

transistors are complementary to the BDX34, BDX34A, BDX34B, and BDX34C p-n-p devices.

All these transistors are supplied in the JEDEC TO-220AB package.

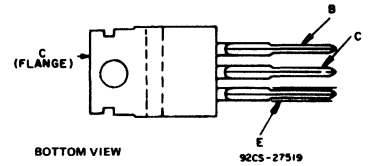
Features:

- Operates from IC without predriver
- Low leakage at high temperature
- High reverse second-breakdown capability

Applications:

- Power switching
- Hammer drivers
- Series and shunt regulators
- Audio amplifiers

TERMINAL DESIGNATIONS



JEDEC TO-220AB

MAXIMUM RATINGS, Absolute-Maximum Values:

	BDX33	BDX33A	BDX33B	BDX33C	BDX33D		
	BDX34	BDX34A	BDX34B	BDX34C*			
COLLECTOR-TO-BASE VOLTAGE	V_{CB0}	45	60	80	100	120	V
COLLECTOR-TO-EMITTER VOLTAGE:							
With external base-to-emitter resistance (R_{BE}) = 100 Ω , sustaining	$V_{CE0}(sus)$	45	60	80	100	120	V
With base open, sustaining	$V_{CE0}(sus)$	45	60	80	100	120	V
With base reverse-biased $V_{BE} = -1.5$ V	$V_{CEX}(sus)$	45	60	80	100	120	V
EMITTER-TO-BASE VOLTAGE	V_{EB0}	5	5	5	5	5	V
CONTINUOUS COLLECTOR CURRENT	I_C	10	10	10	10	10	A
CONTINUOUS BASE CURRENT	I_B	0.25	0.25	0.25	0.25	0.25	A
TRANSISTOR DISSIPATION:	P_T						
At case temperatures up to 25°C		70	70	70	70	70	W
At case temperatures above 25°C			Derate linearly 0.56				W/°C
TEMPERATURE RANGE:							
Storage and Operating (Junction)			-65 to +150				°C
LEAD TEMPERATURE (During Soldering):							
At distances $\geq 1/8$ in. (3.17 mm) from case for 10 s max.			235				°C

* For p-n-p devices, voltage and current values are negative.

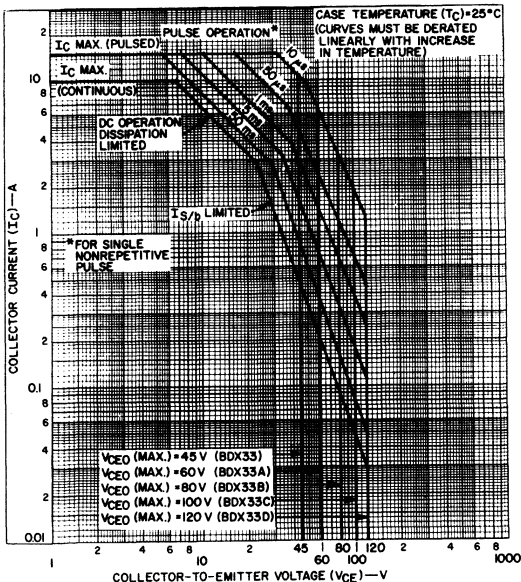


Fig. 1 - Maximum operating areas for BDX33-series types.

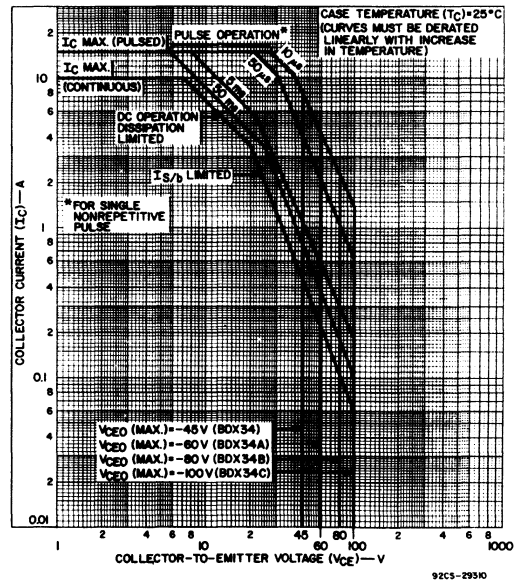


Fig. 2 - Maximum operating areas for BDX34-series types.

BDX33, BDX33A, BDX33B, BDX33C, BDX33D, BDX34, BDX34A, BDX34B, BDX34C

ELECTRICAL CHARACTERISTICS, At Case Temperature (T_C) = 25°C Unless Otherwise Specified

SYMBOL	TEST CONDITIONS [†]					LIMITS										UNITS
	VOLTAGE V dc		CURRENT A dc			BDX33 BDX34 [‡]		BDX33A BDX34A [‡]		BDX33B BDX34B [‡]		BDX33C BDX34C [‡]		BDX33D BDX33D [‡]		
	V _{CB}	V _{CE}	V _{BE}	I _C	I _B	Min.	Max.	Min.	Max.	Min.	Max.	Min.	Max.	Min.	Max.	
I _{CEO} With base open	60 50 40 30 20				0 0 0 0 0	-	-	-	-	-	-	-	-	0.5	0.5	
I _{CEO} T _C = 100°C	60 50 40 30 20				0 0 0 0 0	-	-	-	-	-	-	-	-	10	10	
I _{CBO}	120 100 80 60 45				-	-	-	-	-	-	-	-	-	1	1	
I _{CBO} T _C = 100°C	120 100 80 60 45				-	-	-	-	-	-	-	-	-	5	5	
I _{EBO}			-5 0		-	10	-	10	-	10	-	10	-	10	10	
V _{CEO(sus)}				0.1 [‡] 0.1 [‡] 0.1 [‡]	0 0 0	-	-	-	-	-	-	-	100	120		
V _{CE(sus)} (R _{BE}) = 100Ω				0.1 [‡] 0.1 [‡] 0.1 [‡]	-	-	-	-	-	-	-	-	100	120		
V _{CEV(sus)}			-1.5 -1.5 -1.5	0.1 [‡] 0.1 [‡] 0.1 [‡]	-	-	-	-	-	-	-	-	100	120		
h _{FE}		3 3		3 [‡] 4 [‡]	-	750	-	750	-	750	-	750	-	750		
V _{BE}		3 3		3 [‡] 4 [‡]	-	2.5	-	2.5	-	2.5	-	2.5	-	2.5		
V _{CE(sat)}				3 [‡] 4 [‡]	0.006 0.008	-	2.5	-	2.5	-	2.5	-	2.5	2.5		
V _F				8	-	4	-	4	-	4	-	4	-	4		
h _{fe} f = 1 kHz		5		1	1000	-	1000	-	1000	-	1000	-	1000	-		
h _{fe} f = 1.0 MHz		5		1	20	-	20	-	20	-	20	-	20	-		
E _{S/b} ^b R _{BE} = 100Ω L = 12 mH, types BDX33 types				1.5 4.5	120	-	120	-	120	-	120	-	120	-		
L = 3 mH, BDX34 types				1.5 4.5	30	-	30	-	30	-	30	-	30	-		
I _{S/b} ^b t _p = 0.5 s nonrep. BDX33 types		25 36			2.8 1	-	2.8 1	-	2.8 1	-	2.8 1	-	2.8 1	-		
BDX34 types		-20 -33			-3.5 -1	-	-3.5 -1	-	-3.5 -1	-	-3.5 -1	-	-3.5 -1	-		
R _{θJC}					-	1.78	-	1.78	-	1.78	-	1.78	-	1.78		

[†] For p-n-p devices, voltage and current values are negative.
[‡] Pulsed: Pulse duration = 300 μs, duty factor = 1.8%
^b E_{S/b} is defined as the energy at which second breakdown occurs under specified reverse bias conditions.
 E_{S/b} = 1/2LI² where L is a series load or leakage inductance and I is the peak collector current.

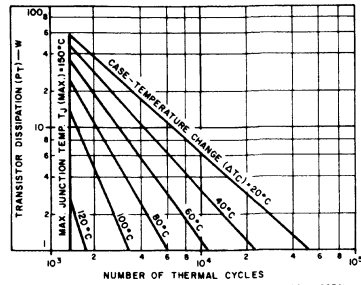


Fig. 3 - Thermal-cycling rating chart for all types.

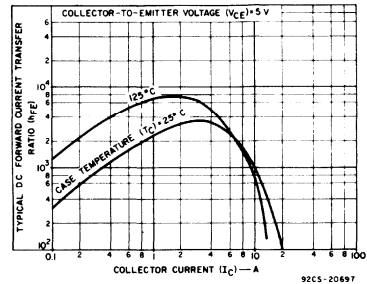


Fig. 4 - Typical dc-beta characteristics for BDX33-series types.

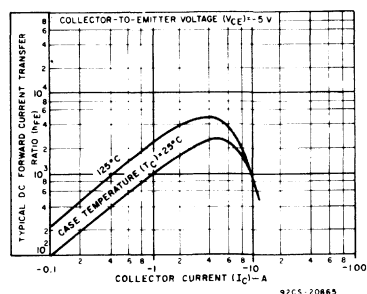


Fig. 5 - Typical dc-beta characteristics for BDX34-series types.

BDX33, BDX33A, BDX33B, BDX33C, BDX33D, BDX34, BDX34A, BDX34B, BDX34C

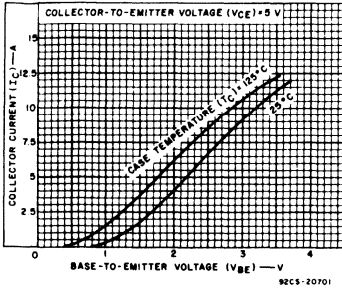


Fig. 6 - Typical transfer characteristics for BDX33-series types.

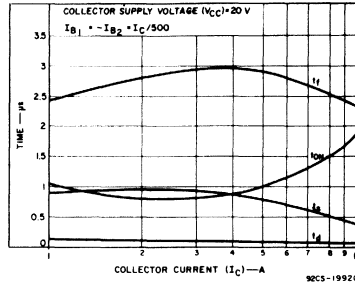


Fig. 7 - Typical saturated switching-time characteristics for BDX33-series types.

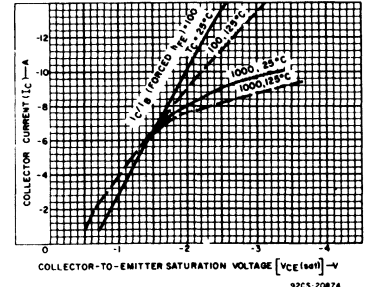


Fig. 8 - Typical saturation characteristics for BDX34-series types.

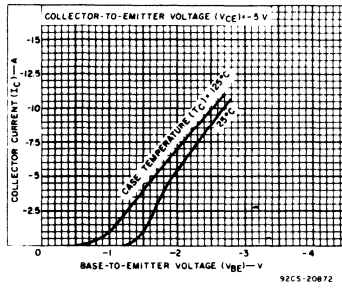


Fig. 9 - Typical transfer characteristics for BDX34-series types.

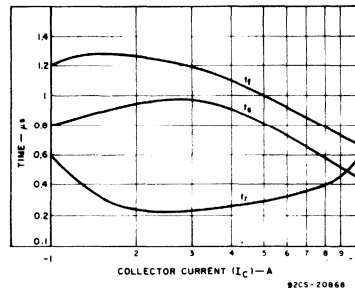


Fig. 10 - Typical saturated switching-time characteristics for BDX34-series types.

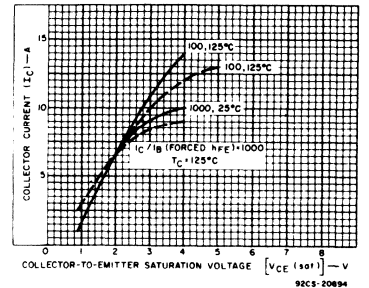


Fig. 11 - Typical saturation characteristics for BDX33-series types.

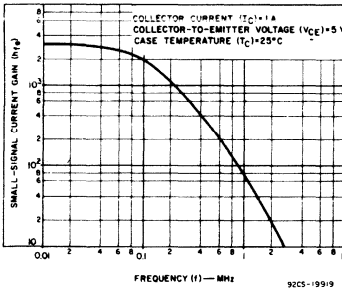


Fig. 12 - Typical small-signal gain for BDX33-series types.

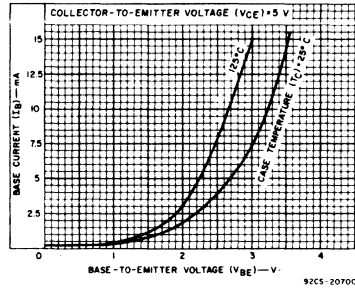


Fig. 13 - Typical input characteristics for BDX33-series types.

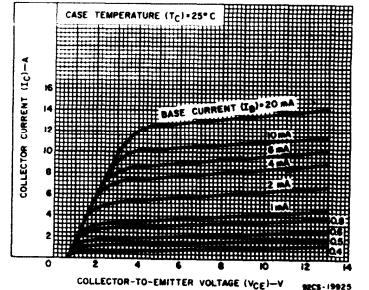


Fig. 14 - Typical output characteristics for BDX33-series types.

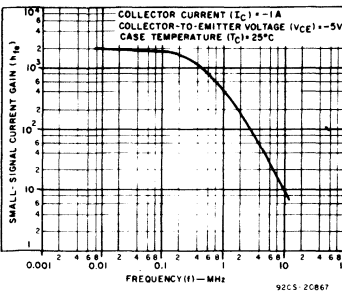


Fig. 15 - Typical small-signal gain for BDX34-series types.

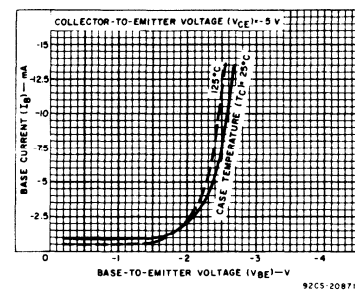


Fig. 16 - Typical input characteristics for BDX34-series types.

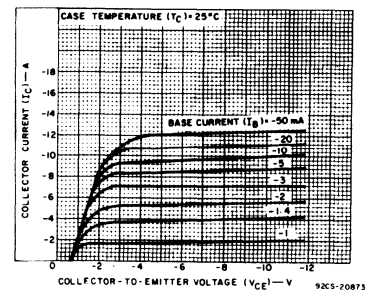


Fig. 17 - Typical output characteristics for BDX34-series types.

BDX83, BDX83A, BDX83B, BDX83C

15-Ampere N-P-N Darlington Power Transistors

40-60-80-100 Volts, 125 Watts

Gain of 1000 at 5 Amperes

The RCA-BDX83, BDX83A, BDX83B, and BDX83C are monolithic silicon Darlington transistors designed for low- and medium-frequency power applications. The high gain of these devices makes it possible for them to be driven directly from integrated circuits.

The BDX83-series types are supplied in the JEDEC TO-3 hermetic steel package.

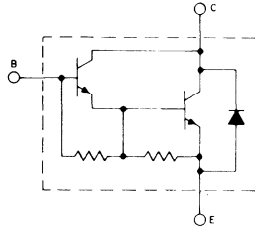


Fig. 1 - Schematic diagram for all types.

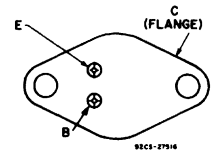
Features:

- Operates from IC without predriver
- Low leakage at high temperature
- High reverse second-breakdown capability

Applications:

- Power switching
- Hammer drivers
- Series and shunt regulators
- Audio amplifiers

TERMINAL DESIGNATIONS



MAXIMUM RATINGS, Absolute-Maximum Values:

	BDX83	BDX83A	BDX83B	BDX83C	
V_{CBC}	45	60	80	100	V
$V_{CEO(sus)}$	45	60	80	100	V
V_{EBO}	5	5	5	5	V
I_C	10	10	10	10	A
I_{CM}	15	15	15	15	A
I_B	0.25	0.25	0.25	0.25	A
P_T					
$T_C \leq 25^\circ C$	125	125	125	125	W
$T_C > 25^\circ C$	Derate linearly at 0.714 W/°C				
T_{stg}, T_J	-65 to +200				°C
T_L	At distances $\geq 1/32$ in. (0.8 mm) from seating plane for 10 s max.				
	235				°C

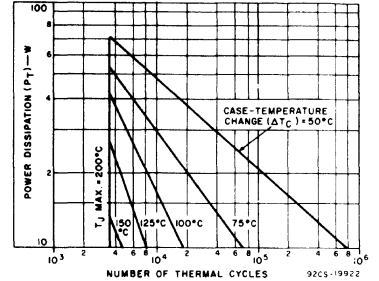


Fig. 3 - Thermal-cycling rating chart for all types.

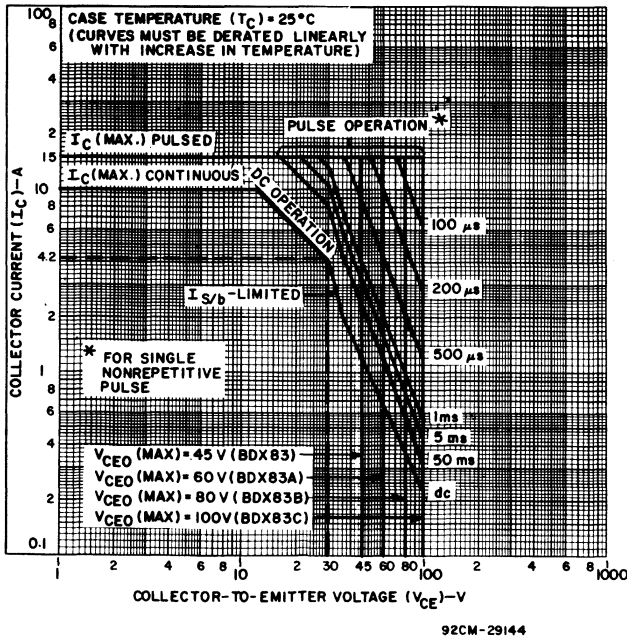


Fig. 2 - Maximum operating area for all types.

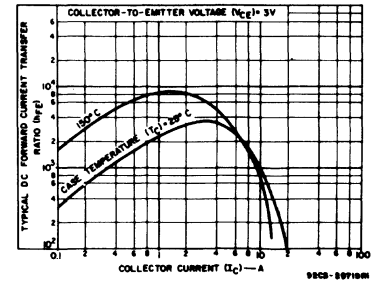


Fig. 4 - Typical dc-beta characteristics for all types.

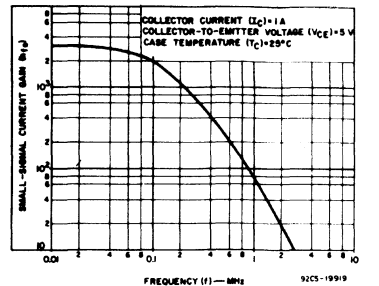


Fig. 5 - Typical small-signal gain for all types.

BDX83, BDX83A, BDX83B, BDX83C

ELECTRICAL CHARACTERISTICS, At Case Temperature (T_C) = 25°C Unless Otherwise Specified

CHARACTERISTIC SYMBOL	TEST CONDITIONS					LIMITS				UNITS
	VOLTAGE V dc			CURRENT A dc		BDX83		BDX83A		
	V_{CE}	V_{EB}	V_{BE}	I_C	I_B	Min.	Max.	Min.	Max.	
I_{CEO}	20 30				0 0	—	1	—	—	mA
I_{CEV}	45 60		-1.5 -1.5			—	0.5	—	—	
$T_C = 150^\circ\text{C}$	45 60		-1.5 -1.5			—	3	—	—	
						—	—	—	3	
I_{EBO}		5		0		—	5	—	5	mA
$V_{CEO(sus)}$				0.1 ^a	0	45	—	60	—	V
h_{FE}	3			1 ^a		750	—	750	—	—
	3			5 ^a		1000	—	1000	—	
	3			10 ^a		250	—	250	—	
V_{BE}	3			5 ^a		—	2.8	—	2.8	V
	3			10 ^a		—	4.5	—	4.5	
$V_{CE(sat)}$				5 ^a	0.01 ^a	—	2	—	2	V
V_F				-10		—	4	—	4	—
h_{fe} f = 1 kHz	5			1		1000	—	1000	—	—
$ h_{fe} $ f = 1 MHz	5			1		20	—	20	—	—
$E_{S/b}$ ^b L = 12 mH, $R_{BE} = 100 \Omega$			-1.5	4.5		120	—	120	—	mJ
$I_{S/b}$ $t = 1 \text{ s}$, non rep.	35					2.2	—	—	—	A
	50					—	—	0.9	—	
	30					4.16	—	4.16	—	
$R_{\theta JC}$						—	1.4	—	1.4	$^\circ\text{C/W}$

^aPulsed: Pulse duration = 300 μs , duty factor = 1.8%.

^b $E_{S/b}$ is defined as the energy at which second breakdown occurs under specified reverse-bias conditions.

$E_{S/b} = \frac{1}{2}LI^2$ where L is a series load or leakage inductance, and I is the peak collector current.

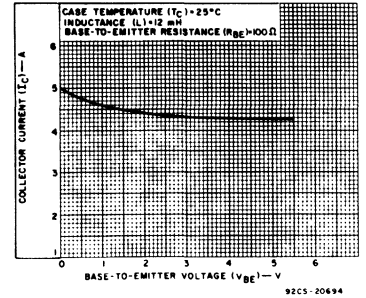


Fig. 6 – Minimum values of reverse-bias second-breakdown characteristic ($E_{S/b}$)^b for all types.

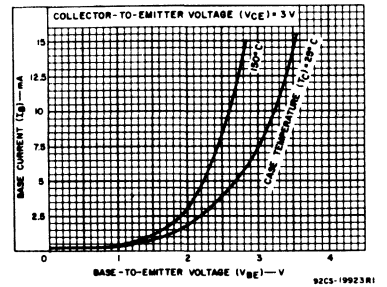


Fig. 7 – Typical input characteristics for all types.

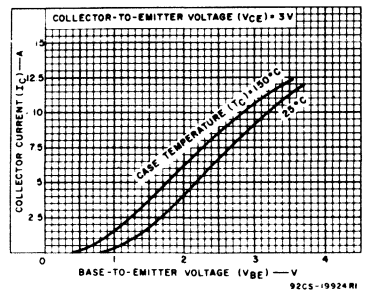


Fig. 8 – Typical transfer characteristics for all types.

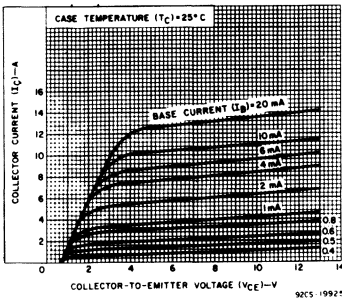


Fig. 9 – Typical output characteristic for all types.

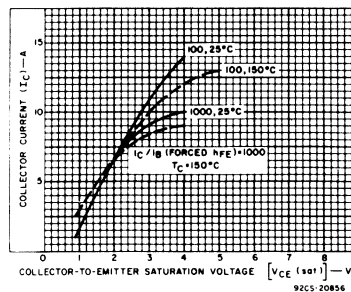


Fig. 10 – Typical saturation characteristics for all types.

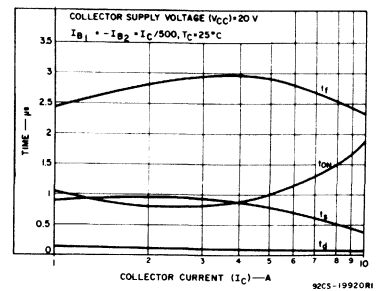


Fig. 11 – Typical saturated switching time characteristics for all types.

BDX83, BDX83A, BDX83B, BDX83C

ELECTRICAL CHARACTERISTICS, At Case Temperature (T_C) = 25°C Unless Otherwise Specified

CHARACTERISTIC SYMBOL	TEST CONDITIONS					LIMITS				UNITS	
	VOLTAGE V dc			CURRENT A dc		BDX83B		BDX83C			
	V_{CE}	V_{EB}	V_{BE}	I_C	I_B	Min.	Max.	Min.	Max.		
I_{CEO}	40				0	-	1	-	-	mA	
	50				0	-	-	-	1		
I_{CEV}	80		-1.5			-	0.5	-	-		
	100		-1.5			-	-	-	0.5		
$T_C = 150^\circ\text{C}$	80		-1.5			-	3	-	-		
	100		-1.5			-	-	-	3		
I_{EBO}		5		0		-	5	-	5		mA
$V_{CEO(sus)}$				0.1 ^a	0	80	-	100	-		V
h_{FE}	3			1 ^a		750	-	750	-		
	3			5 ^a		1000	-	1000	-		
	3			10 ^a		250	-	250	-		
V_{BE}	3			5 ^a		-	2.8	-	2.8	V	
	3			10 ^a		-	4.5	-	4.5		
$V_{CE(sat)}$				5 ^a	0.01 ^a	-	2	-	2	V	
V_F				-10		-	4	-	4		
h_{fe} f = 1 kHz	5			1		1000	-	1000	-		
$ h_{fe} $ f = 1 MHz	5			1		20	-	20	-		
$E_{S/b}$ ^b L = 12 mH, $R_{BE} = 100 \Omega$			-1.5	4.5		120	-	120	-	mJ	
$I_{S/b}$ t = 1 s, non rep.	70					0.37	-	-	-	A	
	85					-	-	0.25	-		
	30					4.16	-	4.16	-		
$R_{\theta JC}$						-	1.4	-	1.4	°C/W	

^aPulsed: Pulse duration = 300 μs, duty factor = 1.8%.

^b $E_{S/b}$ is defined as the energy at which second breakdown occurs under specified reverse-bias conditions.

$E_{S/b} = \frac{1}{2}LI^2$ where L is a series load or leakage inductance, and I is the peak collector current.

BDY29

Hometaxial-Base High-Current Silicon N-P-N Transistor

Rugged Silicon N-P-N Devices for Applications in Industrial and Commercial Equipment

The RCA-BDY29 is a hometaxial-base silicon, n-p-n transistor intended for a wide variety of high-power high-current applications. Typical applications for the BDY29 include power-switching circuits, audio amplifiers, series- and shunt-regulators,

driver and output stages, dc-to-dc converters, inverters, and solenoid (hammer)/relay driver service.

The device is supplied in the popular JEDEC TO-3 package.

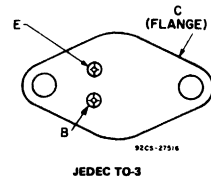
Features:

- High dissipation capability
- High V_{CEX} ratings
- 15-A specification for h_{FE} and $V_{CE(sat)}$
- Low saturation voltage with high beta

MAXIMUM RATINGS, Absolute-Maximum Values:

COLLECTOR-TO-BASE VOLTAGE	V_{CBO}	100	V
COLLECTOR-TO-EMITTER VOLTAGE:			
With $-1.5\text{ V } (V_{BE})$ & $R_{BE} = 100\ \Omega$	V_{CEX}	90	V
With base open	V_{CEO}	75	V
EMITTER-TO-BASE VOLTAGE	V_{EBO}	7	V
CONTINUOUS COLLECTOR CURRENT	I_C	30	A
PEAK COLLECTOR CURRENT	I_{CM}	30	A
CONTINUOUS BASE CURRENT	I_B	7.5	A
TRANSISTOR DISSIPATION:	P_T		
At case temperatures up to 25°C		220	W
At case temperatures above 25°C		Derate linearly to 200°C	
TEMPERATURE RANGE:			
Storage & Operating (Junction)		-65 to 200	$^\circ\text{C}$
PIN TEMPERATURE (During soldering):			
At distance $\geq 1/32$ in. (0.8 mm) from seating plane for 10 s max.		230	$^\circ\text{C}$

TERMINAL DESIGNATIONS



ELECTRICAL CHARACTERISTICS, At Case Temperature (T_C) = 25°C Unless Otherwise Specified

CHARACTERISTIC	SYMBOL	TEST CONDITIONS					LIMITS		UNITS
		VOLTAGE V dc			CURRENT A dc		BDY29		
		V_{CB}	V_{CE}	V_{BE}	I_C	I_B	Min.	Max.	
Collector Cutoff Current:									
With emitter open	I_{CBO}	100					-	1	mA
With base-emitter junction reverse-biased	I_{CEX}	100	-1.5				-	1	mA
With base-emitter junction reverse-biased & $T_C = 150^\circ\text{C}$	I_{CEX}	100	-1.5				-	10	mA
With base open	I_{CEO}	60			0		-	2	mA
Emitter Cutoff Current	I_{EBO}			-7	0		-	2	mA
DC Forward Current Transfer Ratio	h_{FE}			2	15 ^a		15	60	
Collector-to-Emitter Sustaining Voltage:									
With base-emitter junction reverse-biased ($R_{BE} = 100\ \Omega$)	$V_{CEX(sus)}$			-1.5	0.2		90	-	V
With external base-to-emitter resistance ($R_{BE} = 100\ \Omega$)	$V_{CER(sus)}$				0.2		85	-	V
With base open	$V_{CEO(sus)}$				0.2	0	75	-	V
Base-to-Emitter Voltage	V_{BE}			4	30 ^a		-	3.5	V
Collector-to-Emitter Saturation Voltage	$V_{CE(sat)}$				15 ^a	1.5	-	1.2	V
Second-Breakdown Collector Current:									
With base forward-biased and 1-s, nonrepetitive pulse	$I_{S/b}^b$		60				3.66	-	A
Second-Breakdown Energy:									
With base reverse-biased and $L = 40\text{ mH}$, $R_{BE} = 100\ \Omega$	$E_{S/b}^c$			-1.5	5		500	-	mJ
Magnitude of Common-Emitter, Small-Signal, Short-Circuit, Forward Current Transfer Ratio: $f = 0.05\text{ MHz}$	$ h_{fe} $			4		1	4	16 (Typ.)	
Common-Emitter, Small-Signal, Short-Circuit, Forward Current Transfer Ratio: $f = 1\text{ kHz}$	h_{fe}			4		1	40	-	
Thermal Resistance: Junction-to-Case	$R_{\theta JC}$						-	0.8	$^\circ\text{C/W}$

^aPulsed; pulse duration = 300 μs , rep. rate = 60 Hz; duty factor $\leq 2\%$.

^b $I_{S/b}$ is defined as the current at which second breakdown occurs at a specified collector voltage with the emitter-base junction forward biased for transistor operation in the active region.

^c $E_{S/b}$ is defined as the energy at which second breakdown occurs under specified reverse-bias conditions. $E_{S/b} = 1/2LI^2$, where L is a series load or leakage inductance and I is the peak collector current.

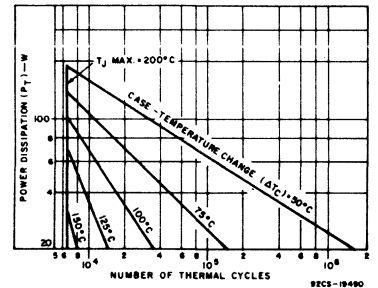


Fig. 1 - Thermal-cycling rating chart.

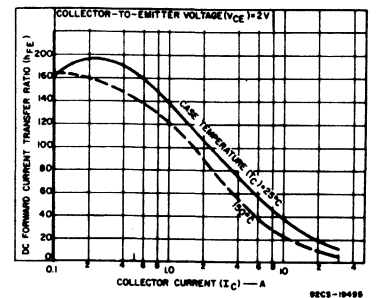


Fig. 2 - Typical dc beta characteristics.

BDY29

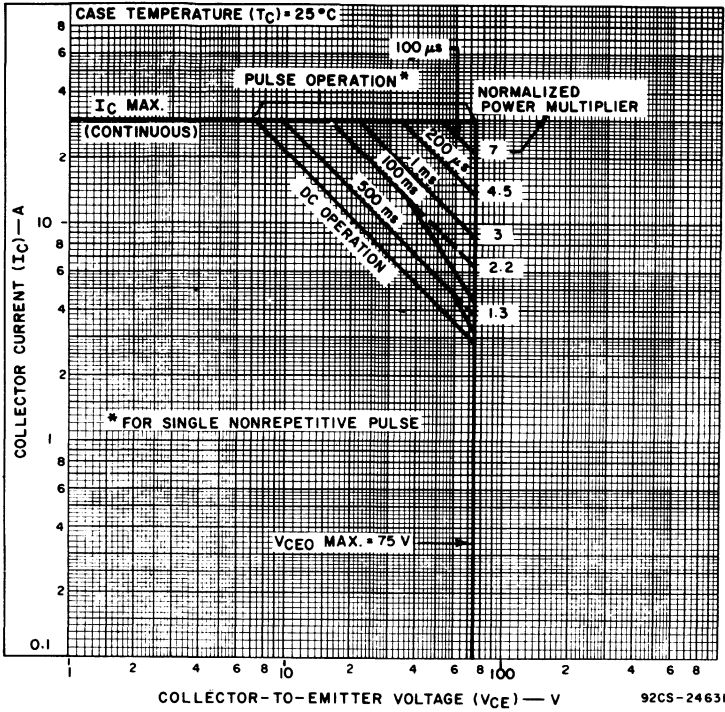


Fig. 3 - Maximum operating areas.

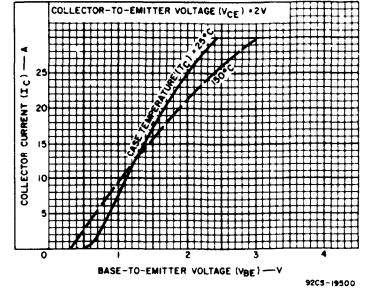


Fig. 4 - Typical transfer characteristics.

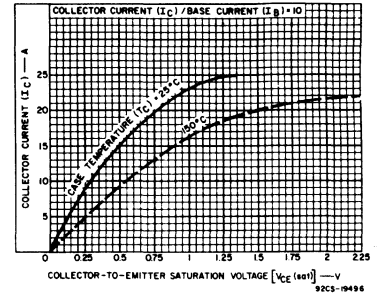


Fig. 5 - Typical saturation-voltage characteristics.

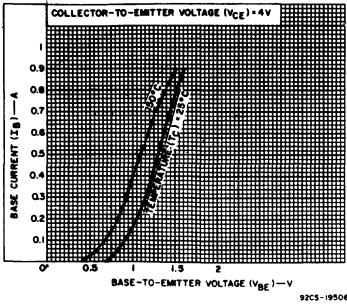


Fig. 6 - Typical input characteristics.

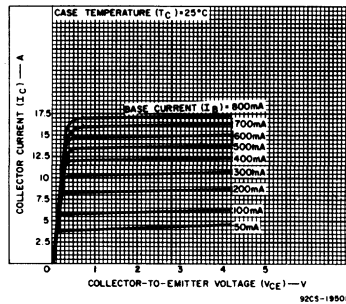


Fig. 7 - Typical output characteristics.

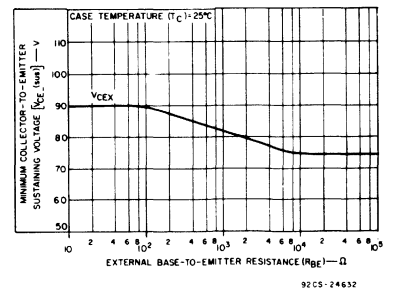


Fig. 8 - Sustaining voltage vs. base-to-emitter resistance.

BDY37

Hometaxial-Base, High-Current Silicon N-P-N Transistor

Rugged High-Voltage Device for Applications in Industrial and Commercial Equipment

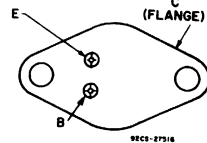
The RCA-BDY 37 is a hometaxial-base silicon n-p-n transistor intended for a wide variety of high-voltage high-current applications. Typical applications include power-switching circuits, audio amplifiers, series- and shunt-regulator driver

and output stages, dc-to-dc converters, inverters, and solenoid (hammer)/relay driver service. The BDY 37 employs the popular JEDEC TO-3 package.

Features:

- High dissipation capability - 150 W
- 8-A specification for h_{FE} , V_{BE} , and $V_{CE(sat)}$
- $V_{CEX} - 160$ V min.
- Low saturation voltage with high beta

TERMINAL DESIGNATIONS



JEDEC TO-3

MAXIMUM RATINGS, Absolute-Maximum Values:

COLLECTOR-TO-BASE VOLTAGE	V_{CB0}	160	V
COLLECTOR-TO-EMITTER VOLTAGE:			
With base open	V_{CE0}	140	V
With reverse bias (V_{BE}) of -1.5 V	V_{CEX}	160	V
EMITTER-TO-BASE VOLTAGE	V_{EB0}	7	V
COLLECTOR CURRENT:			
Continuous	I_C	16	A
Peak	I_{CM}	30	A
BASE CURRENT:			
Continuous	I_B	4	A
Peak	I_{BM}	15	A
TRANSISTOR DISSIPATION:			
At case temperatures up to 25°C	P_T	150	W
At case temperatures above 25°C			Derate linearly to 200°C
TEMPERATURE RANGE:			
Storage & Operating (Junction)		-65 to +200	°C
PIN TEMPERATURE (During Soldering):			
At distances $\geq 1/32$ in. (0.8 mm) from case for 10 s max.		230	°C

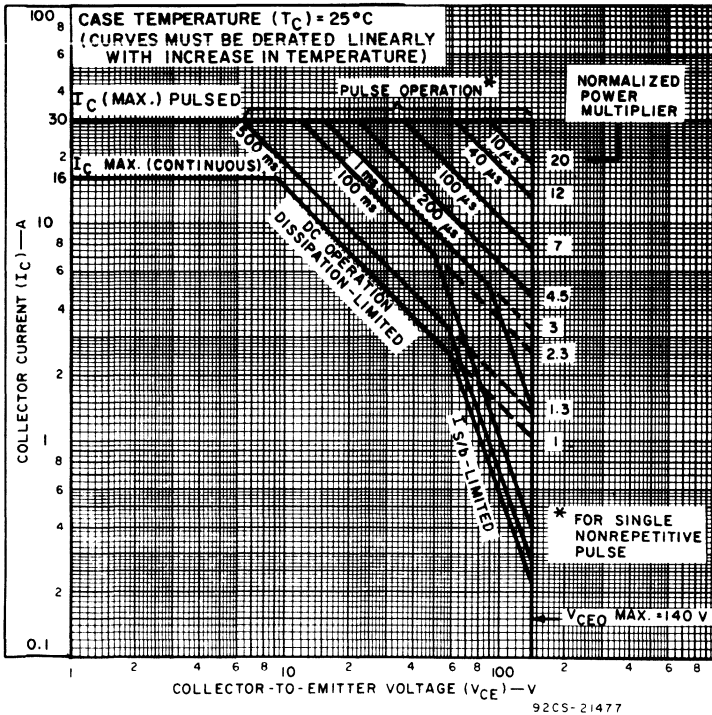


Fig. 1 - Maximum operating areas.

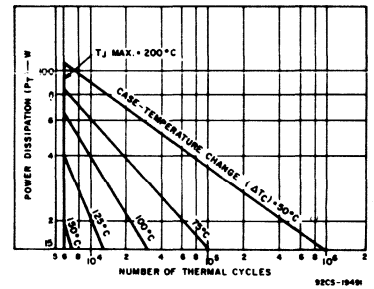


Fig. 2 - Thermal-cycling rating chart.

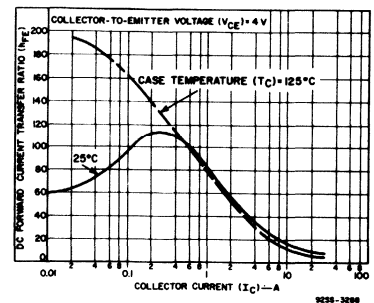


Fig. 3 - Typical dc beta characteristics.

BDY37

ELECTRICAL CHARACTERISTICS, At Case Temperature (T_C) = 25°C Unless Otherwise Specified

CHARACTERISTIC	SYMBOL	TEST CONDITIONS							LIMITS		UNITS
		VOLTAGE V dc				CURRENT A dc			BDY37		
		V_{CB}	V_{CE}	V_{EB}	V_{BE}	I_C	I_E	I_B	Min.	Max.	
Collector-Cutoff Current: With emitter open	I_{CBO}	140					0		-	2	mA
With base-emitter junction reverse-biased	I_{CEX}		140		-1.5				-	2	mA
With base-emitter junction reverse-biased and $T_C = 150^\circ\text{C}$	I_{CEX}		140		-1.5				-	10	mA
With base open	I_{CEO}		120				0		-	10	mA
Emitter-Cutoff Current	I_{EBO}			7		0			-	5	mA
DC Forward-Current Transfer Ratio	h_{FE}		4			8 ^a			15	60	
Collector-to-Emitter Sustaining Voltage: With base-emitter junction reverse- biased ($R_{BE} = 100 \Omega$)	$V_{CEX(sus)}$				-1.5	0.1			160	-	V
With external base-to-emitter resistance ($R_{BE} = 100 \Omega$)	$V_{CER(sus)}$					0.2 ^a			150	-	V
With base open	$V_{CEO(sus)}$					0.2 ^a	0	140	-	-	V
Base-to-Emitter Voltage	V_{BE}		4			8 ^a			-	2.2	V
Collector-to-Emitter Saturation Voltage	$V_{CE(sat)}$					8 ^a	0.8		-	1.4	V
Second-Breakdown Collector Current: With base forward-biased and 1-s nonrepetitive pulse	$I_{S/b}$		60						2.5	-	A
Second-Breakdown Energy: With base reverse-biased and $L = 40 \text{ mH}$, $R_{BE} = 100 \Omega$	$E_{S/b}$				-1.5	2.5			0.125	-	J
Magnitude of Common-Emitter, Small-Signal, Short-Circuit, Forward-Current Transfer Ratio ($f = 50 \text{ kHz}$)	$ h_{fe} $		4			1			4	-	
Common-Emitter, Small-Signal, Short-Circuit, Forward-Current Transfer Ratio ($f = 1 \text{ kHz}$)	h_{fe}		4			1			40	-	
Thermal Resistance: Junction-to-Case	$R_{\theta JC}$								-	1.17	$^\circ\text{C/W}$

- ^a Pulsed; pulse duration = 300 μs , rep. rate = 60 Hz, duty factor $\leq 2\%$.
- ^b $I_{S/b}$ is defined as the current at which second breakdown occurs at a specified collector voltage with the emitter-base junction forward-biased for transistor operation in the active region.
- ^c $E_{S/b}$ is defined as the energy at which second breakdown occurs under specified reverse-bias conditions. $E_{S/b} = 1/2LI^2$ where L is a series load or leakage inductance and I is the peak collector current.

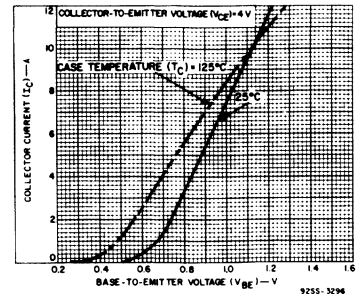


Fig. 4 - Typical transfer characteristics.

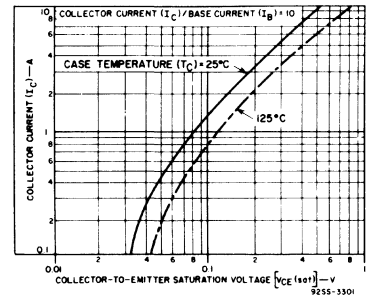


Fig. 5 - Typical saturation-voltage characteristics.

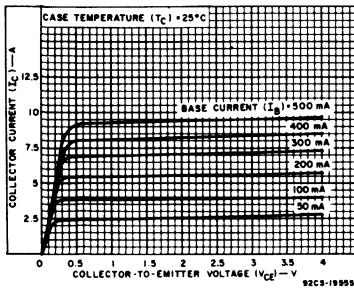


Fig. 6 - Typical output characteristics.

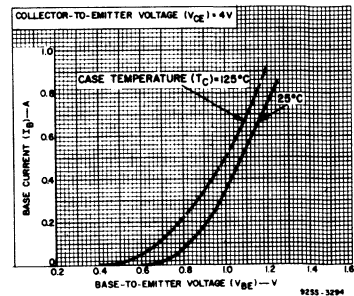


Fig. 7 - Typical input characteristics.

BDY71

Hometaxial-Base, Medium-Power Silicon N-P-N Transistor

For Intermediate-Power Applications in Industrial and Commercial Equipment

The RCA-BDY71 is a hometaxial-base silicon n-p-n transistor intended for a wide variety of medium- to high-power applications. It is supplied in the JEDEC TO-66 hermetic package.

MAXIMUM RATINGS, Absolute-Maximum Values:

COLLECTOR-TO-BASE VOLTAGE	V _{CB0}	90	V
COLLECTOR-TO-EMITTER VOLTAGE:			
With base open	V _{CE0}	55	V
With external base-to-emitter resistance (R _{BE}) = 100Ω	V _{CER(sus)}	60	V
With base reverse-biased (V _{BE} = -1.5 V)	V _{CEV(sus)}	90	V
EMITTER-TO-BASE VOLTAGE	V _{EB0}	7	V
CONTINUOUS COLLECTOR CURRENT	I _C	4	A
CONTINUOUS BASE CURRENT	I _B	2	A
TRANSISTOR DISSIPATION:	P _T		
At case temperature up to 25°C		29	W
At temperatures above 25°C		Derate linearly to 200°C	
TEMPERATURE RANGE:			
Storage & Operating (Junction)		-65 to 200	°C
PIN TEMPERATURE (During Soldering):			
At distance ≥ 1/32 in. (0.8 mm) from seating plane for 10 s max.		235	°C

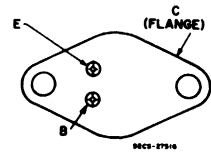
Applications:

- Power switching circuits
- Series- and shunt-regulator driver and output stages
- High-fidelity amplifiers
- Solenoid drivers

Features:

- Maximum safe-area-of-operation curves for dc and pulse operation
- V_{CEV(sus)} = 90 V min
- Low saturation voltage: V_{CE(sat)} = 1.0 V at I_C = 0.5 A

TERMINAL DESIGNATIONS



JEDEC TO-66

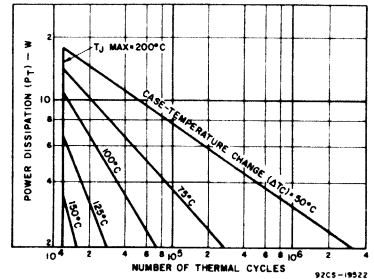


Fig. 2 — Thermal-cycling rating chart.

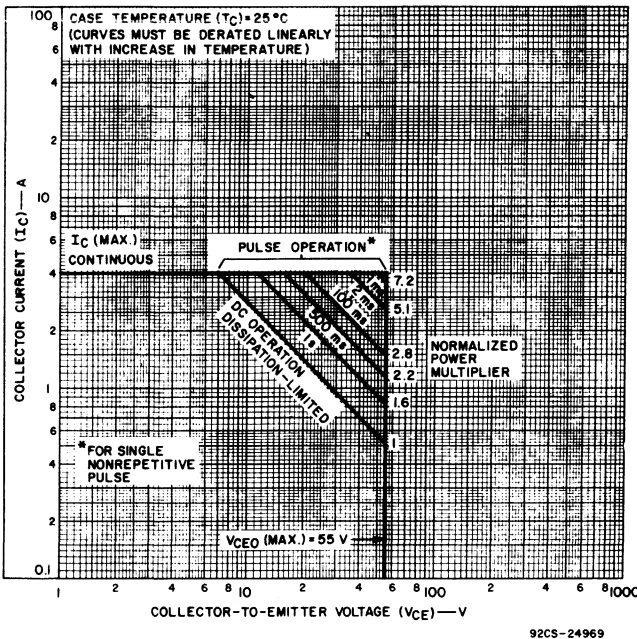


Fig. 1 — Maximum operating areas for BDY71.

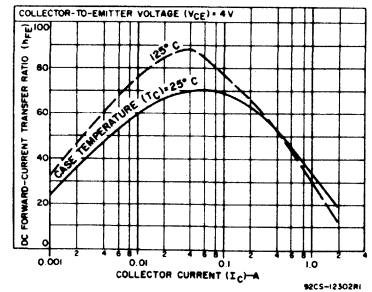


Fig. 3 — Typical dc beta characteristics.

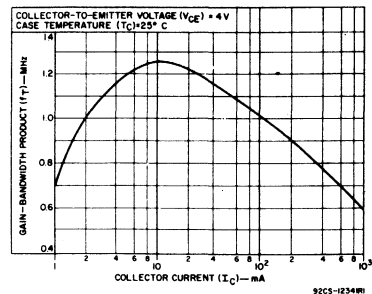


Fig. 4 — Typical gain-bandwidth product.

BDY71

ELECTRICAL CHARACTERISTICS, At Case Temperature (T_C) = 25°C Unless Otherwise Specified

CHARACTERISTIC	SYMBOL	TEST CONDITIONS				LIMITS		UNITS
		VOLTAGE V dc		CURRENT A dc		BDY71		
		V_{CE}	V_{BE}	I_C	I_B	Min.	Max.	
Collector-Cutoff Current: With base open	I_{CEO}	30			0	-	0.5	mA
With base-emitter junction reverse-biased	I_{CEX}	90	-1.5			-	1	mA
at $T_C = 150^\circ\text{C}$	I_{CEX}	90	-1.5			-	6	mA
Emitter-Cutoff Current	I_{EBO}		-7		0	-	1	mA
Collector-to-Emitter Sustaining Voltage: With base open	$V_{CEO(sus)}$			0.1^a	0	55	-	V
With external base-to-emitter resistance ($R_{BE} = 100\Omega$)	$V_{CER(sus)}$			0.1^a		60	-	V
DC Forward-Current Transfer Ratio	h_{FE}	4 4		3^a 0.5^a		5 80	- 200	
Collector-to-Emitter Saturation Voltage	$V_{CE(sat)}$			0.5^a 3^a	0.05^a 1^a	- -	1 6	V
Base-to-Emitter Voltage	V_{BE}	4		0.5		-	1.7	V
Common-Emitter, Small-Signal, Short-Circuit, Forward Current Transfer Ratio Cutoff Frequency	f_{hfe}	4		0.1		0.03	-	MHz
Gain-Bandwidth Product: $f = 0.4$ MHz	f_T			0.2		800	-	kHz
Common-Emitter, Small-Signal, Short-Circuit Forward Current Transfer Ratio: $f = 1$ kHz	h_{fe}	4		0.1		25	-	
Forward-Bias Second Break- down Collector Current: $t = 1$ -s nonrepetitive	$I_{S/b}$	55				525	-	mA
Thermal Resistance: Junction-to-Case	$R_{\theta JC}$					6.3	-	$^\circ\text{C/W}$

^aPulsed: Pulse duration = 300 μs , duty factor = 1.8%.

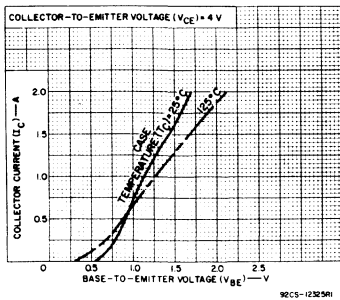


Fig. 5 – Typical transfer characteristics.

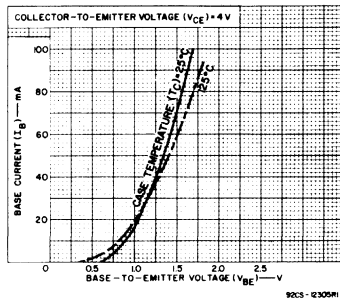


Fig. 6 – Typical input characteristics.

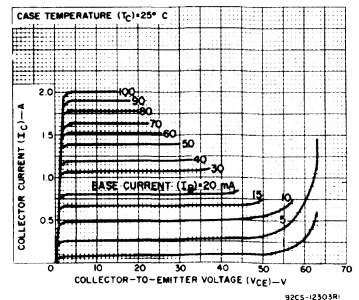


Fig. 7 – Typical output characteristics.

High-Voltage Silicon N-P-N Transistors

For High-Speed Switching and Linear-Amplifier Applications in Military, Industrial and Commercial Equipment

RCA-BFT19, BFT19A, and BFT19B are silicon p-n-p transistors with high breakdown voltages, high frequency response, and fast switching speeds. These transistors differ in their voltage ratings. They are supplied in the JEDEC TO-39 hermetic package.

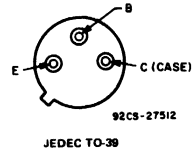
Typical applications include high-voltage differential and operational amplifiers; high-voltage inverters, and high-voltage, low-current switching and series regulators.

BFT19, BFT19A, BFT19B

Features:

- Maximum safe-area-of-operation curves
- High voltage ratings:
 $V_{CBO} = -400$ V max. (BFT19B); -300 V max. (BFT19A); -200 V max. (BFT19)
 $V_{CE0(sus)} = -350$ V max. (BFT19B); -250 V max. (BFT19A); -150 V max. (BFT19)

TERMINAL DESIGNATIONS



MAXIMUM RATINGS, Absolute-Maximum Values:

	BFT19	BFT19A	BFT19B		
COLLECTOR-TO-BASE VOLTAGE	V_{CBO}	-200	-300	-400	V
COLLECTOR-TO-EMITTER SUSTAINING VOLTAGE:					
With base open	$V_{CE0(sus)}$	-150	-250	-350	V
With external base-to-emitter resistance ($R_{BE} = 100 \Omega$)	$V_{CER(sus)}$	-200	-300	-400	V
EMITTER-TO-BASE VOLTAGE	V_{EBO}	-5	-5	-5	V
COLLECTOR CURRENT (Continuous)	I_C	-1	-1	-1	A
BASE CURRENT (Continuous)	I_B	-0.5	-0.5	-0.5	A
TRANSISTOR DISSIPATION:	P_T				
At case temperatures up to 25°C		5	5	5	W
At case temperatures above 25°C		Derate linearly to 200°C			
At ambient temperatures up to 25°C		1	1	1	W
At ambient temperatures above 25°C		Derate linearly at 5.7 mW/°C			
TEMPERATURE RANGE:					
Storage and Operating (Junction)		← -65 to 200 →			°C
PIN TEMPERATURE (During Soldering):					
At distance $\geq 1/32$ in. (0.8 mm) from case for 10 s max.		← 255 →			°C

ELECTRICAL CHARACTERISTICS, At Case Temperature (T_C) = 25°C

CHARACTERISTIC	SYMBOL	TEST CONDITIONS						LIMITS						
		VOLTAGE			CURRENT			BFT19		BFT19A		BFT19B		LIMITS
		V_{CB}	V_{CE}	V_{EB}	I_C	I_E	I_B	Min.	Max.	Min.	Max.	Min.	Max.	
Collector-Cutoff Current: With emitter open	I_{CBO}	-100 -200 -300				0 0 0		-100		-100				μ A
Emitter-Cutoff Current	I_{EBO}			-5	0			-100		-100		-100		μ A
DC Forward-Current Transfer Ratio	h_{FE}		-10 -10 -10		-10 -30 -50		20 25 20		20 25 20		20 25 20			
Collector-to-Emitter Sustaining Voltage With base open	$V_{CE0(sus)}$				-10	0	-150 ^A		-250 ^A		-350 ^A			V
With external base-to-emitter resistance ($R_{BE} = 100 \Omega$)	$V_{CER(sus)}$				-10		-200 ^A		-300 ^A		-400 ^A			V
Base to Emitter Saturation Voltage	$V_{BE(sat)}$				-30		-3	-1.8		-1.8		-1.8		V
Collector to Emitter Saturation Voltage	$V_{CE(sat)}$				-10 -30		-1 -3	-1		-1		-1		V
Common-Emitter, Small-Signal, Short-Circuit, Forward-Current Transfer Ratio (at 1 kHz)	h_{fe}		-10		-5		25		25		25			
Magnitude of Common-Emitter, Small-Signal, Short-Circuit Forward Current Transfer Ratio (at 5 MHz)	$ h_{fe} $		-10		-30		5		5		5			
Common-Base, Short-Circuit, Input Capacitance (at 1 MHz)	C_{ib}			-5	0			75		75		75		pF
Output Capacitance (at 1 MHz)	C_{ob}		-10		0			15		15		15		pF
Second-Breakdown Collector Current With base forward biased	$I_{S/B}$		-100				-50		-50		-50			mA
Thermal Resistance (Junction-to-Case)	$R_{\theta JC}$							35		35		35		°C/W

^A CAUTION: The sustaining voltages $V_{CE0(sus)}$ and $V_{CER(sus)}$ MUST NOT be measured on a curve tracer.

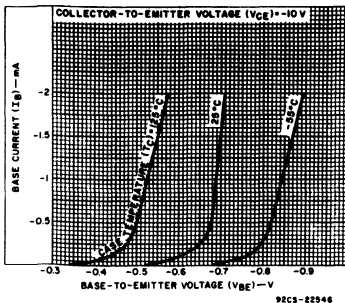


Fig. 3 - Typical input characteristics.

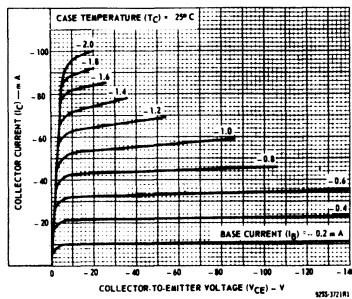


Fig. 4 - Typical output characteristics.

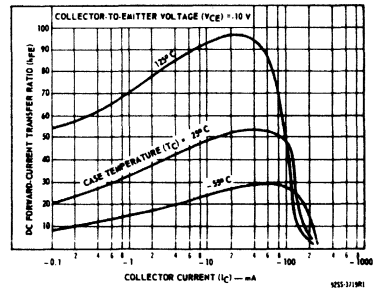


Fig. 1 - Typical dc beta characteristics.

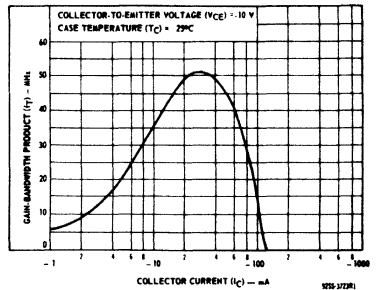


Fig. 2 - Typical gain-bandwidth product.

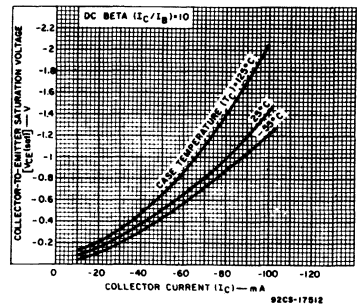


Fig. 5 - Typical collector-to-emitter saturation voltage.

BFT19, BFT19A, BFT19B

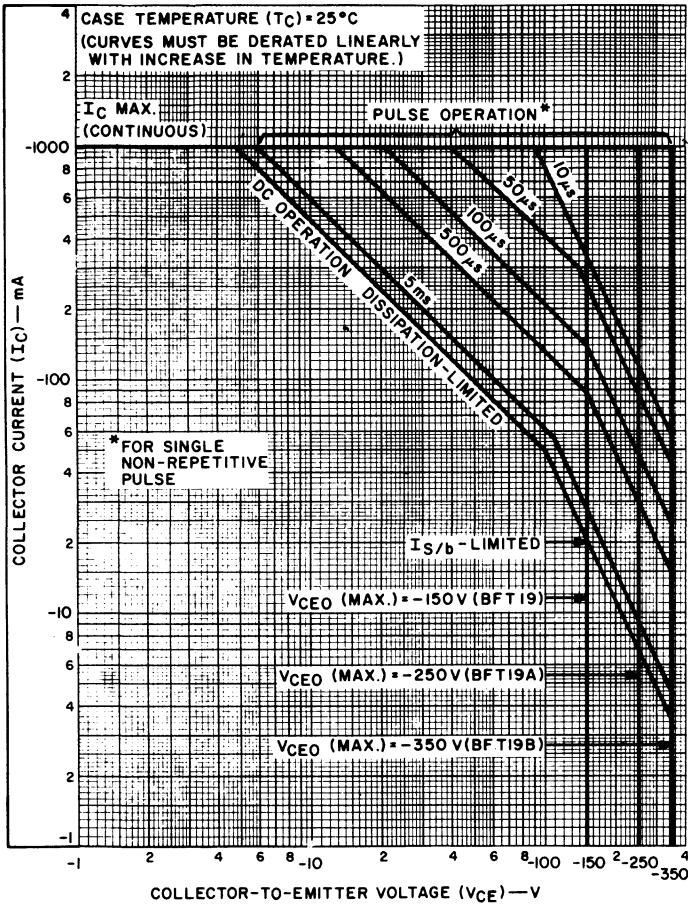


Fig. 6 - Maximum operating areas for all types.

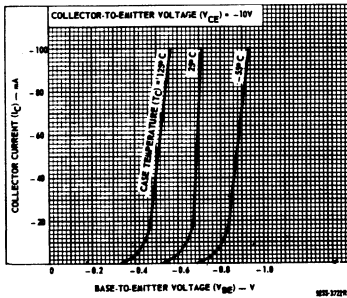


Fig. 9 - Typical transfer characteristics.

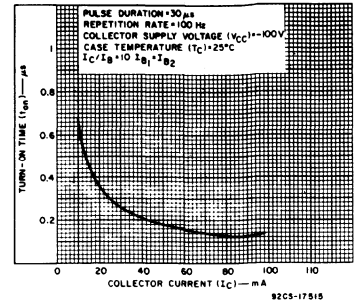


Fig. 7 - Typical turn-on time characteristics.

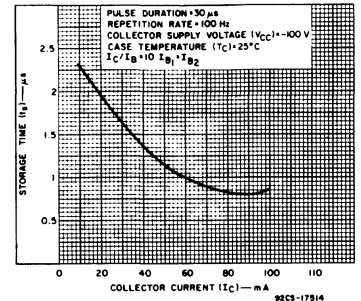


Fig. 8 - Typical storage-time characteristic.

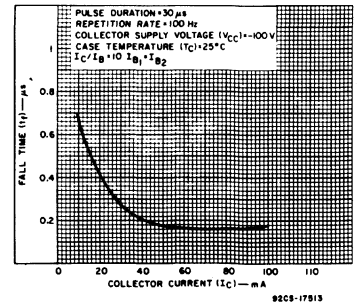


Fig. 10 - Typical fall-time characteristic.

BFT28, BFT28A, BFT28B, BFT28C,

High-Voltage Silicon P-N-P Transistors

For High-Speed Switching and Linear-Amplifier Applications in Military, Industrial and Commercial Equipment

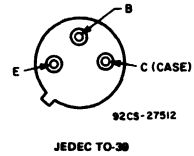
The RCA-BFT28, BFT28A, BFT28B and BFT28C are silicon p-n-p transistors with high breakdown voltages, high frequency response, and fast switching speeds. They are supplied in the JEDEC TO-39 hermetic package.

These transistors differ primarily in their voltage ratings. Typical applications include high-voltage differential and operational amplifiers; high-voltage inverters; and high-voltage, low-current switching and series regulators.

Features:

- Maximum safe-area-of-operation curves
- High voltage ratings:
 - V_{CEO} = -150 V max. (BFT 28); -200 V max. (BFT28A); -250 V max. (BFT 28 B); -300 V max. (BFT28C)
 - V_{CEO(sus)} = -100 V max. (BFT 28); -150 V max. (BFT28A); -200 V max. (BFT28B); -250 V max. (BFT28C)

TERMINAL DESIGNATIONS



MAXIMUM RATINGS, Absolute-Maximum Values:

	BFT28	BFT28A	BFT28B	BFT28C		
COLLECTOR-TO-BASE VOLTAGE	-150	-200	-250	-300	V	
COLLECTOR-TO-EMITTER SUSTAINING VOLTAGE:						
With external base-to-emitter resistance (R _{BE}) = 100 Ω	V _{CE(sus)}	-150	-200	-250	-300	V
With base open	V _{CEO(sus)}	-100	-150	-200	-250	V
EMITTER-TO-BASE VOLTAGE	V _{EBO}	-4	-4	-4	-4	V
COLLECTOR CURRENT	I _C	-1	-1	-1	-1	A
BASE CURRENT	I _B	-0.5	-0.5	-0.5	-0.5	A
TRANSISTOR DISSIPATION:						
At case temperatures up to 25°C		5	5	5	5	W
At case temperatures above 25°C		Derate linearly to 200°C				
At ambient temperatures up to 50°C		1	1	1	1	W
At ambient temperatures above 50°C		Derate linearly at				
		5.7	5.7	5.7	5.7	mW/°C
TEMPERATURE RANGE:						
Storage and Operating (Junction)		-65 to +200				°C
LEAD TEMPERATURE (During soldering):						
At distance ≥ 1/32 in. (0.8 mm) from seating plane for 10 s max.		255				°C

ELECTRICAL CHARACTERISTICS, At Case Temperature (T_C) = 25°C

CHARACTERISTIC	SYMBOL	TEST CONDITIONS					LIMITS								UNITS
		VOLTAGE V dc			CURRENT mA dc		BFT28		BFT28A		BFT28B		BFT28C		
		V _{CB}	V _{CE}	V _{EB}	I _C	I _B	Min.	Max.	Min.	Max.	Min.	Max.	Min.	Max.	
Collector-Cutoff Current: With emitter open	I _{CBO}														μA
		-50	-75	-150			-	-1	-	-	-	-	-	-	
Emitter-Cutoff Current	I _{EBO}			-4	0		-	-100	-	-100	-	-100	-	-100	μA
DC Forward-Current Transfer Ratio	h _{FE}		-10		-10 ⁶		20	-	20	-	20	-	20	-	
Collector-to-Emitter Sustaining Voltage: With base open	V _{CEO(sus)}				-10	0	-100 ^B	-	-150 ^B	-	-200 ^B	-	-250 ^B	-	V
With external base-to-emitter resistance (R _{BE}) = 100 Ω	V _{CE(sus)}				-10		-150 ^B	-	-200 ^B	-	-250 ^B	-	-300 ^B	-	V
Base-to-Emitter Saturation Voltage	V _{BE(sat)}				-30 ^C	-3	-	-1.5	-	-1.5	-	-1.5	-	-1.5	V
Collector-to-Emitter Saturation Voltage	V _{CE(sat)}				-10 ^C	-1	-	-0.6	-	-0.6	-	-5	-	-5	V
Common-Emitter, Small-Signal, Short-Circuit, Forward-Current Transfer Ratio: f = 1 kHz	h _{fe}		-10		-5		25	-	25	-	25	-	25	-	
Magnitude of Common-Emitter, Small-Signal, Short-Circuit Forward-Current Transfer Ratio: f = 5 MHz	h _{fe}		-10		-30		5	-	5	-	5	-	5	-	
Common-Base, Short-Circuit, Input Capacitance: f = 1 MHz	C _{ib}				-5	0	-	75	-	75	-	75	-	75	pF
Output Capacitance: f = 1 MHz	C _{ob}	-10					-	15	-	15	-	15	-	15	pF
Forward-Bias, Second Breakdown Collector Current: 0.4 s non-repetitive pulse	I _{S/2b}		-80				-62.5	-	-62.5	-	-62.5	-	-62.5	-	mA
Thermal Resistance: Junction-to-Case	R _{θJC}						-	35	-	35	-	35	-	35	°C/W

■ CAUTION: The sustaining voltages V_{CEO(sus)} and V_{CE(sus)} MUST NOT be measured on a curve tracer.

^BI_{S/2b} is defined as the current at which second breakdown occurs at a specified collector voltage.

^CPulsed, pulse duration = 300 μs; duty factor < 2%.

BFT28, BFT28A, BFT28B, BFT28C

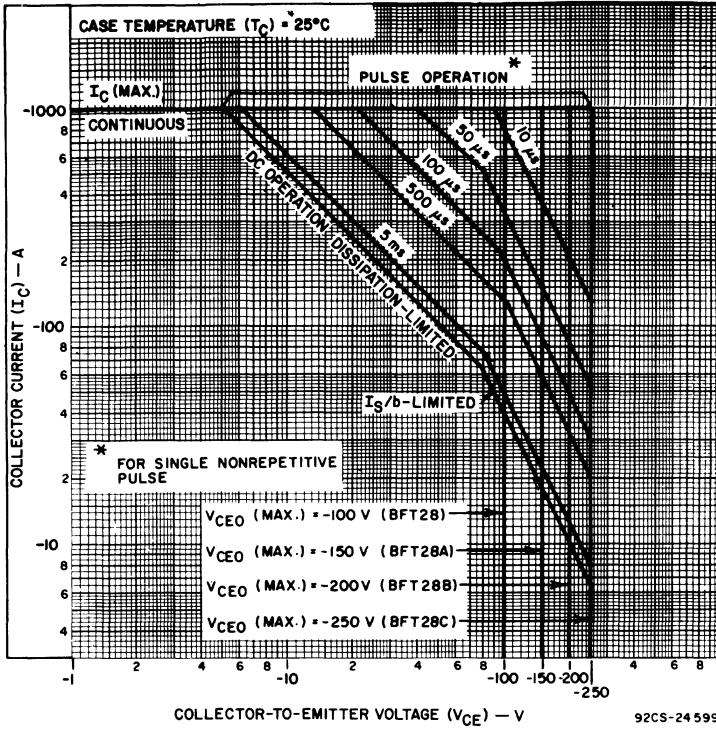


Fig. 1 - Maximum safe operating areas.

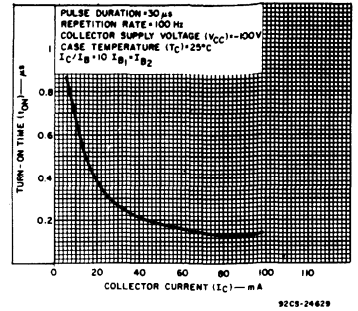


Fig. 2 - Typical turn-on time characteristic for all types.

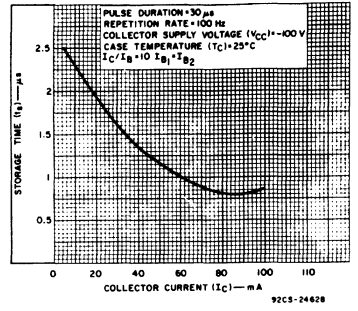


Fig. 3 - Typical storage-time characteristic for all types.

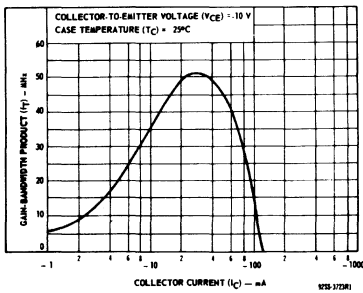


Fig. 4 - Typical gain-bandwidth product for all types.

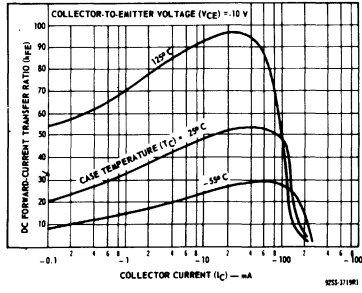


Fig. 5 - Typical dc beta characteristics for all types.

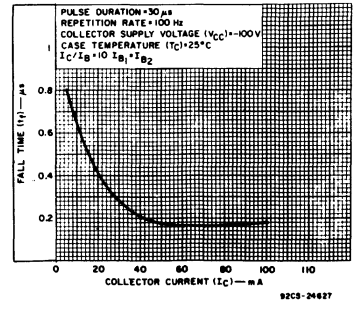


Fig. 6 - Typical fall-time characteristic for all types.

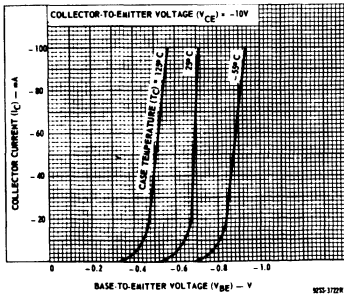


Fig. 7 - Typical transfer characteristics for all types.

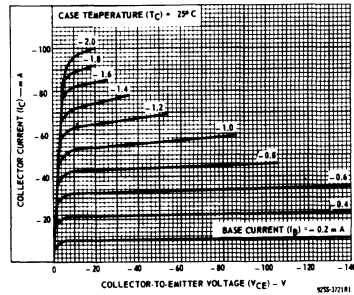


Fig. 8 - Typical output characteristics for all types.

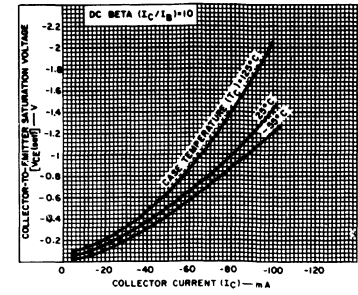


Fig. 9 - Typical collector-to-emitter saturation voltage for all types.

BU106

Epitaxial-Base Silicon N-P-N Transistor

For Horizontal Deflection for Small-Screen Black-and-White TV

BU106 is a silicon n-p-n transistor with a pi-nu epitaxial-layer construction. This device is supplied in a JEDEC TO-3 hermetic package. The BU106 is primarily intended for use in horizontal-deflection output stages in small-screen black-and-white television receivers.

This transistor is supplied in the JEDEC TO-3 hermetic package.

Features:

- Maximum safe-area-of-operation curves
- Low saturation voltages
- High voltage ratings
- High dissipation rating

MAXIMUM RATINGS, Absolute-Maximum Values:

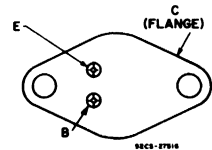
COLLECTOR-TO-BASE VOLTAGE	V _{CB0}	325	V
COLLECTOR-TO-EMITTER SUSTAINING VOLTAGE:			
With base open	V _{CE0(sus)}	140	V
With base reverse-biased (V _{BE}) between -2 V ~ 8 V	V _{CEV(sus)}	325	V
EMITTER-TO-BASE VOLTAGE	V _{EBO}	8	V
CONTINUOUS COLLECTOR CURRENT	I _C	7	A
PEAK COLLECTOR CURRENT		10	A
CONTINUOUS BASE CURRENT	I _B	4	A
TRANSISTOR DISSIPATION:	P _T		
At case temperatures up to 25°C and V _{CE} up to 40 V		75	W
At case temperatures up to 25°C and V _{CE} above 40 V		See Fig. 3	
At case temperatures above 25°C		Derate linearly to 200°C	
TEMPERATURE RANGE:			
Storage and Operating (Junction)		-65 to +200	°C
PIN TEMPERATURE (During Soldering):			
At distances ≥ 1/32 in (0.8 mm) from seating plane for 10 s max.		230	°C

ELECTRICAL CHARACTERISTICS, At Case Temperature (T_C) = 25°C Unless Otherwise Specified

CHARACTERISTIC	SYMBOL	TEST CONDITIONS						LIMITS		UNITS
		VOLTAGE V dc			CURRENT A dc			BU106		
		V _{CE}	V _{EB}	V _{BE}	I _C	I _B	I _E	MIN.	MAX.	
Collector Cutoff Current: With base open	I _{CEO}	100				0		-	2	mA
With base-emitter junction reverse-biased	I _{CEV}	325		-1.5				-	2	
With base-emitter junction reverse-biased and T _C = 100°C		325		-1.5				-	5	
Emitter-Cutoff Current	I _{EBO}		8			0		-	10	mA
Collector-to-Emitter Sustaining Voltage (See Figs. 4 and 5): With base open	V _{CE0(sus)}					0.1 ^a	0	140	-	V
With base-emitter junction reverse-biased	V _{CEV(sus)}			-2		0.05 ^a		325	-	
Emitter-to-Base Voltage	V _{EBO}					0.01		8	-	V
DC Forward-Current Transfer Ratio	h _{FE}	5				4 ^a		8	-	
Base-to-Emitter Saturation Voltage	V _{BE(sat)}					4 ^a	0.5	-	1.5	V
Collector-to-Emitter Saturation Voltage	V _{CE(sat)}					4 ^a	0.5	-	5	V
Magnitude of Common-Emitter, Small-Signal, Short-Circuit, Forward Current Transfer Ratio (f = 1 MHz)	h _{fe}	10				0.2		3	-	
Common Base Output Capacitance (f = 1 MHz)	C _{ob}	V _{CB} = 10					0	150	-	pF
Forward-Bias Second Breakdown Collector Current (1-s non-repetitive pulse)	I _{S/b}	40						1.85	-	A
Switching Time: Storage (V _{CC} = 40 V)	t _s					4	0.5 ^c	-	3	μs
Turn-off (V _{CC} = 40 V)	t _{OFF}	2				0.1		-	1.5	
Thermal Resistance Junction-to-Case	R _{θJC}	10				5		-	2.34	°C/W

^a Pulsed; pulse duration ≤ 350 μs, Duty factor = 2%.
^b CAUTION: The sustaining voltages V_{CE0(sus)} and V_{CEV(sus)}, MUST NOT be measured on a curve tracer.
^c I_{B1} = I_{B2} = value shown.
^d Turn-off is measured when V_{CE} has reached a value of 2 V and I_C has decreased to 100 mA.

TERMINAL DESIGNATIONS



JEDEC TO-3

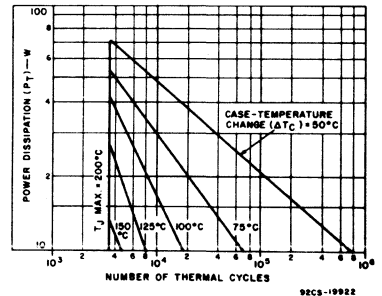


Fig. 1 - Thermal-cycling rating chart.

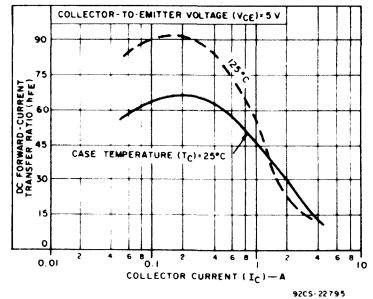


Fig. 2 - Typical dc beta characteristics.

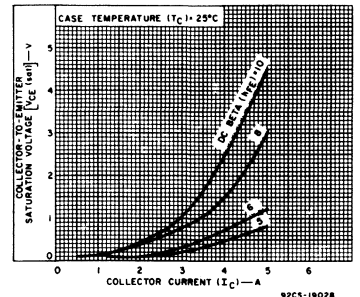


Fig. 3 - Typical saturation voltage characteristics.

BU106

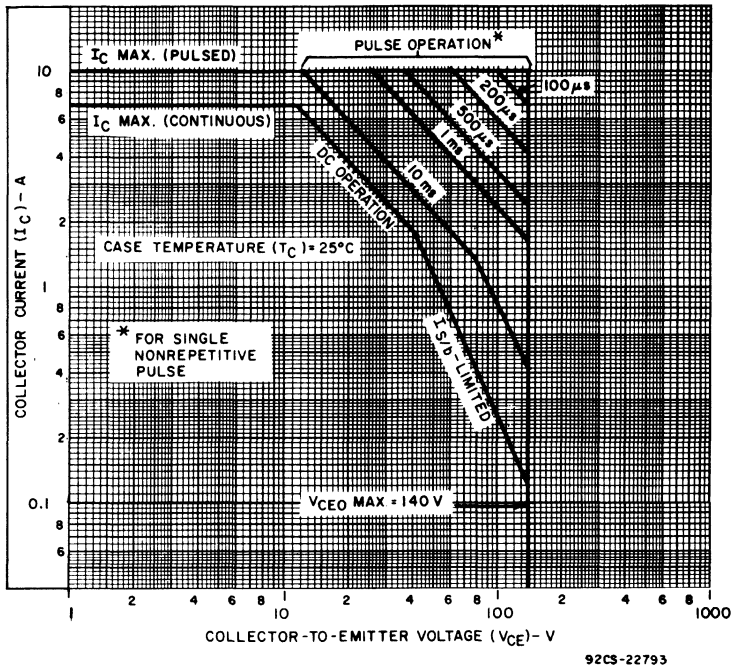


Fig. 4 - Maximum operating areas.

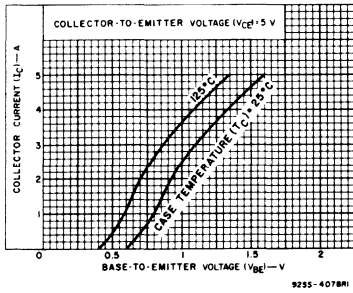


Fig. 5 - Typical transfer characteristics.

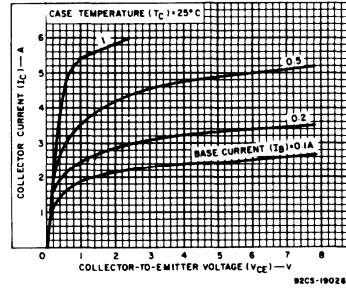


Fig. 6 - Typical output characteristics.

BU126, BU133

High-Voltage, Power-Switching Silicon N-P-N Transistors

TV Colour/Monochrome Receiver Power Supplies -90° and 110° Deflection Angles

The RCA-BU126 and BU133 are silicon epitaxial-collector n-p-n power switching transistors intended for use in switched-mode power supplies of 90° and 110° colour and black-and-white TV receivers.

These devices are hermetically sealed in a steel JEDEC TO-3 package.

Features:

- Fast switching speed
- Hermetic steel package – JEDEC TO-3
- Epitaxial pi-nu construction

MAXIMUM RATINGS, Absolute-Maximum Values:

	BU126	BU133	
V _{CES}	750	750	V
V _{CEV}			
V _{BE} = -1.5 V	750	750	V
V _{CEO(sus)}	300	250	V
V _{EBO}	6	6	V
I _C	3	3	A
I _{CM}	6	6	A
I _B	2	2	A
P _T			
Up to 25°C	80	80	W
Above 25°C	Derate linearly to 200°C		
T _J , T _{stg}	-65 to 200		°C
T _L	235		°C

At distances ≥ 1/32 in. (0.8 mm) from seating plane for 10 s max.

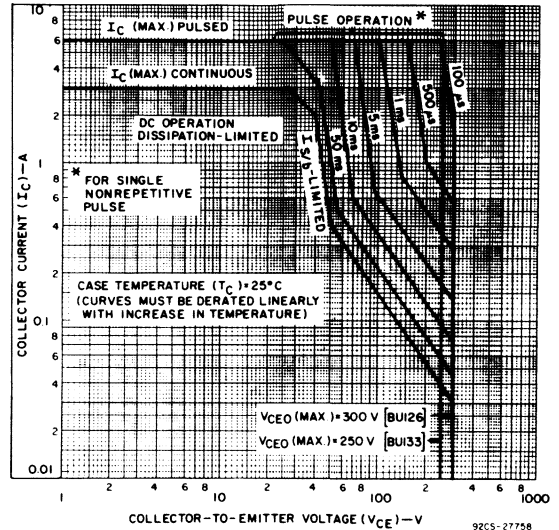


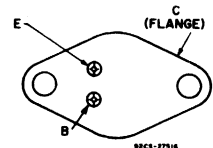
Fig. 1 – Maximum operating areas for BU126, BU133.

ELECTRICAL CHARACTERISTICS, At Case Temperature (T_C) = 25°C Unless Otherwise Specified

SYMBOL	TEST CONDITIONS				LIMITS				UNITS
	VOLTAGE V dc		CURRENT A dc		BU126		BU133		
	V _{CE}	V _{BE}	I _C	I _B	Min.	Max.	Min.	Max.	
I _{CES}	750	0			–	500	–	500	µA
T _C = 125°C	750	0			–	2	–	2	mA
I _{EBO}		-6			–	5	–	5	mA
h _{FE}	5		1a		15	60	15	80	
V _{CEO(sus)}			0.1 ^a	0	300 ^b	–	250 ^b	–	V
V _{BE(sat)}			4 ^a	1	–	1.5	–	1.5	V
V _{CE(sat)}			2.5 ^a	0.25	–	10	–	10	V
			4 ^a	1	–	5	–	5	V
I _{S/b}	40				2	–	2	–	V
t = 1 s nonrep.	200				50	–	50	–	mA
f _T	10		0.2		3.5 typ.		3.5 typ.		MHz
t _s			2.5	0.25 ^c	1.5 typ.	2.4	1.5 typ.	2.4	µs
V _{CC} = 50 V									
t _f			2.5	0.25 ^c	0.5 typ.	0.9	0.5 typ.	0.9	µs
V _{CC} = 50 V ^d									
R _{θJC}					–	2.18	–	2.18	°C/W

^a Pulsed: pulse duration = 300 µs, rep. rate = 50 Hz, duty factor = 2%
^b CAUTION: The sustaining voltage V_{CEO(sus)} MUST NOT be measured on a curve tracer.
^c I_{B1} = I_{B2}
^d Full-time characteristics measured in a typical switched-mode power supply show an average value of 0.16 µs.

TERMINAL DESIGNATIONS



BOTTOM VIEW

JEDEC TO-3

BU207, BU208, BU208A

High-Voltage, High-Current Silicon N-P-N Power-Switching Transistors

For Horizontal-Deflection Circuit
Application in TV Receivers

The RCA BU207, BU208 and BU208A are silicon n-p-n power switching transistors. These types utilize a trimetal metallization-process to achieve a balanced-current distribution throughout the chip.

They are intended for horizontal-deflection circuit application in black and white and color television receivers, and for other applications where a combination of high-current handling capability, ruggedness, and fast-switching speeds are required.

Features:

- Al-Ti-Ni Metalization — Clip Construction
- Ion Implantation for Stringent Control of Diffusion and Electrical Parameters
- Hard Glass-Passivation
- Fast Switching Speeds
- Low Saturation Voltages
- Wide Safe-Area-of-Operation
- Low Thermal Resistance

MAXIMUM RATINGS, Absolute-Maximum Values:

	BU207	BU208	BU208A	
V_{CES}	1300	1500	1500	V
$V_{CEO(sus)}$	600	700	700	V
V_{EBO}	—	5	—	V
I_C	—	5	—	A
I_{CM}	—	7.5	—	A
I_{BM}	—	4	—	A
$-I_{BM}$	—	-3.5	—	A
P_T				
T_C up to 95°C.	—	12.5	—	W
T_C above 95°C, Derate Linearly	—	0.625	—	W/°C
T_{stg} , T_J	—	-65 to 115	—	°C
T_L				
At distance $\geq 1/16$ in. (1.39 mm) from seating plane for 10 s max.	—	230	—	°C

TERMINAL DESIGNATIONS

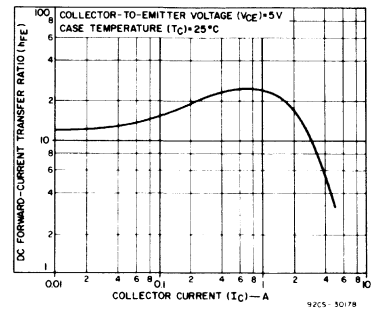
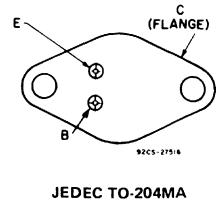


Fig. 2 — Typical dc beta characteristic as a function of collector current.

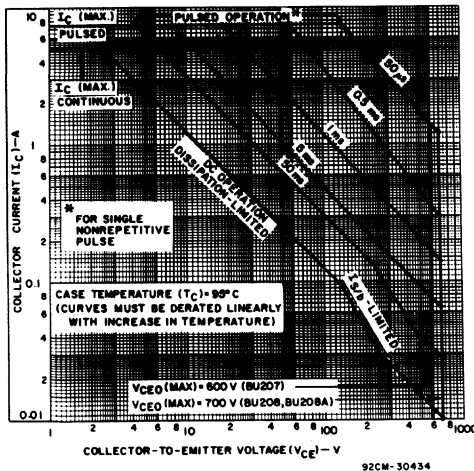


Fig. 1 — Maximum operating areas for all types ($T_C = 95^\circ C$).

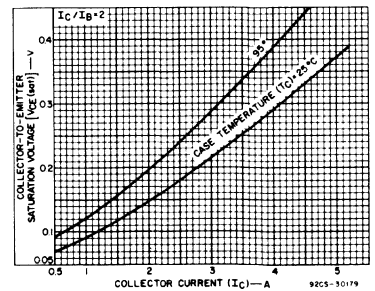


Fig. 3 — Typical collector-to-emitter saturation voltage as a function of collector current.

BU207, BU208, BU208A

ELECTRICAL CHARACTERISTICS, At Case Temperature (T_C) = 25°C unless otherwise specified

CHARACTERISTIC	TEST CONDITIONS				LIMITS						UNITS
	VOLTAGE		CURRENT		BU207		BU208		BU208A		
	V dc	V dc	A dc	A dc	Min.	Max.	Min.	Max.	Min.	Max.	
I_{CES}	1300			0	-	1	-	-	-	-	mA
	1500			0	-	-	-	1	-	1	
I_{EBO}		4	0		-	0.5	-	0.5	-	0.5	V
$V_{CEO(sus)}$			0.1 ^b	0	600 ^a	-	700 ^a	-	700 ^a	-	
V_{EBO}				0.1	5	-	5	-	5	-	V
h_{FE}	5	4.5 ^b			2.25	-	2.25	-	2.5	-	
$V_{BE(sat)}$			4.5 ^b	2	0.9 ^c	1.5	0.9 ^c	1.5	0.9 ^c	1.5	V
$V_{CE(sat)}$			4.5 ^b	2	1.5 ^c	5	1.5 ^c	5	-	1	
f_T	5		0.1		1 (Typ.)		1 (Typ.)		1 (Typ.)		MHz
C_{ob}	10 ^d				160 (Typ.)		160 (Typ.)		160 (Typ.)		pF
t_s			4.5	1.8	10 (Typ.)		10 (Typ.)		10 (Typ.)		μ s
t_f			4.5	1.8	0.6 (Typ.)		0.6 (Typ.)		0.6 (Typ.)		
$R_{\theta JC}$					-	1.6	-	1.6	-	1.6	$^{\circ}$ C/W

a CAUTION: The sustaining voltage $V_{CEO(sus)}$ MUST NOT be measured on a curve tracer. $V_{CEO(sus)}$ should be measured by a pulse method with the test conditions $I_C = 100$ mA, $L = 25$ μ H, $I_B = 0$.

b Pulsed; pulse duration = 300 μ s, duty factor $\leq 2\%$.
 c Typical value
 d V_{CB}

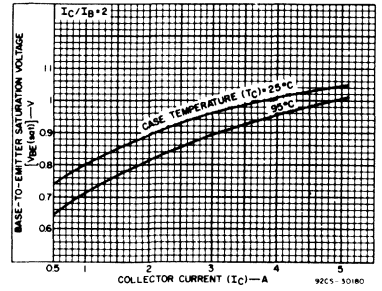


Fig. 4 - Typical base-to-emitter saturation voltage as a function of collector current.

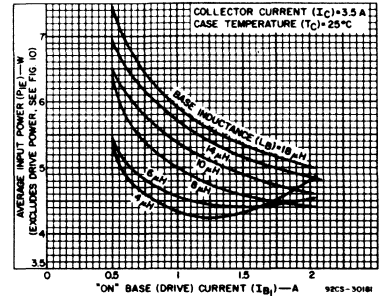


Fig. 5 - Guide for optimizing "drive" conditions at 3.5A in test circuit, Fig. 1. See also Guide for Optimizing 'ON' and 'OFF' Base (Drive) Current Conditions p.4.

Guide for Optimizing "ON" and "OFF" Base (Drive) Current Conditions

Two very important conditions, both of which must be satisfied, provide the key to reliable and efficient operation of a horizontal-deflection circuit. The first condition is complete collector saturation. This is accomplished by supplying sufficient "on" base (drive) current, I_{B1} , to assure total saturation of the lowest-gain devices at end of scan current, I_{CM} , and yet not over-driving higher-gain devices. Component tolerances must also be taken into account while selecting I_{B1} .

The second condition and possibly the most important is the removal of excessive carriers in the high-resistivity collector region at I_{CM} to eliminate dissipation from collector current fall-time "tailing". This is accomplished by selecting the proper amount of series base inductance, L_B , to slow down the decay of reverse-base current, sometimes referred to as di_{B2}/dt , inherent in low-impedance circuits. This enables complete recombination of

excess carriers in the collector region while current in the base region is still flowing.

The proper value for L_B can easily be determined from Figure 6 and 7 after I_{B1} , I_{CM} , and transistor dc beta range at maximum collector, h_{FE} , have been established. Care should be taken to assure that the combination of a low I_{B1} and high L_B does not cause the transistor to pull out of saturation before the unit is completely turned off causing dynamic saturation losses or that a high I_{B1} and a low L_B does not cause high dissipation due to collector current turn-off "tailing".

Figures 5 and 6 show that, once I_{CM} has been established, a value for L_B and I_{B1} can be selected, that will result in low dissipation and reliable operation for various ranges of h_{FE}/I_{B1} . Once I_{B1} has been selected, figure 10 may be used as a guide to determine the proper di_{B2}/dt value over a range of collector current.

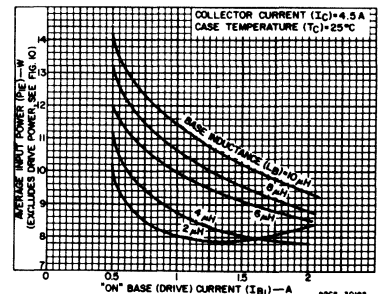


Fig. 6 - Guide for optimizing "drive" conditions at 4.5A in test circuit, Fig. 1. See also "Guide for Optimizing 'ON' and 'OFF' Base (Drive) Current Conditions".

BU207, BU208, BU208A

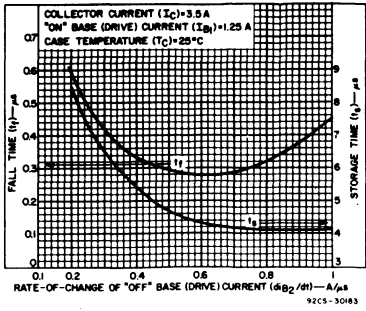


Fig. 7 — Typical fall time and storage time characteristics as a function of "off" base (drive) current ($I_C = 3.5A$).

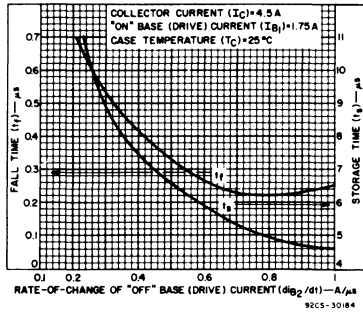


Fig. 8 — Typical fall time and storage time characteristics as a function of "off" base (drive) current ($I_C = 4.5A$).

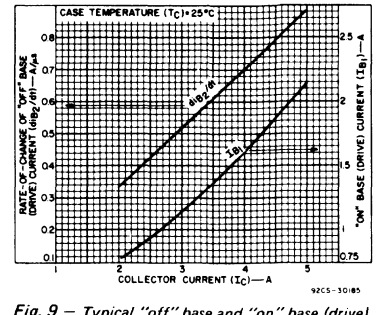


Fig. 9 — Typical "off" base and "on" base (drive) current as a function of collector current. See also "Guide for Optimizing 'ON' and 'OFF' Base (Drive) Current Conditions'".

BUX16, BUX16A, BUX16B, BUX16C

High-Voltage, High-Power Silicon N-P-N Power Transistors

For Switching and Linear Applications in Industrial, and Commercial Equipment

The RCA BUX16-series devices are multiple epitaxial silicon n-p-n power transistors employing a new overlay construction with several emitter sites. All devices employ the popular JEDEC TO-3 package; they differ in breakdown-voltage, leakage-current, and current-gain values.

The high breakdown-voltage ratings and exceptional second-breakdown capabilities of these transistors make them especially suitable for use in series regulators, power amplifiers, inverters, deflection circuits, switching regulators, and high-voltage bridge amplifiers.

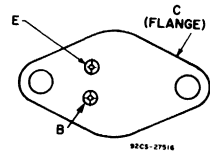
Features:

- High voltage ratings: $V_{CER(sus)}$ up to 400 V, $R_{BE} \leq 50 \Omega$, $V_{CEO(sus)}$ up to 350 V
- High power dissipation rating: $P_T = 100$ W at $V_{CE} = 135$ V, $T_C = 25^\circ\text{C}$
- For switching applications where circuit values and operating conditions require a transistor with a high second breakdown rating ($I_{S/b}$) (limit line begins at 135 V)
- Maximum area-of-operation curves for dc and pulse operation

MAXIMUM RATINGS, Absolute-Maximum Values:

	BUX16	BUX16A	BUX16B	BUX16C	
COLLECTOR-TO-BASE VOLTAGE	250	325	375	425	V
COLLECTOR-TO-EMITTER VOLTAGE					
With base reverse-biased ($V_{BE} = -1.5$ V)	V_{CEV}	250	325	375	V
With external base-to-emitter resistance ($R_{BE} \leq 50 \Omega$)	$V_{CER(sus)}$	225	300	350	400
With base open	$V_{CEO(sus)}$	200	250	300	350
EMITTER-TO-BASE VOLTAGE	V_{EBO}	6	6	6	V
CONTINUOUS COLLECTOR CURRENT	I_C	5	5	5	A
CONTINUOUS BASE CURRENT	I_B	2	2	2	A
TRANSISTOR DISSIPATION:					
At case temperatures up to 25°C and V_{CE} up to 135 V		100	100	100	100
At case temperatures up to 25°C and V_{CE} above 135 V					See Fig. 1
At case temperatures above 25°C					Derate linearly to 200°C
TEMPERATURE RANGE:					
Storage and operating (Junction)			-65 to 200		$^\circ\text{C}$
PIN TEMPERATURE (During soldering):					
At distance $\geq 1/32$ in. (0.8 mm) from seating plane for 10 s max.	T_p		230		$^\circ\text{C}$

TERMINAL DESIGNATIONS



JEDEC TO-3

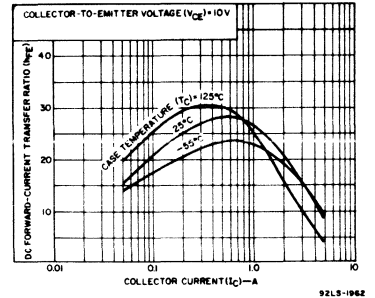


Fig. 2 - Typical dc beta vs. collector current for all types.

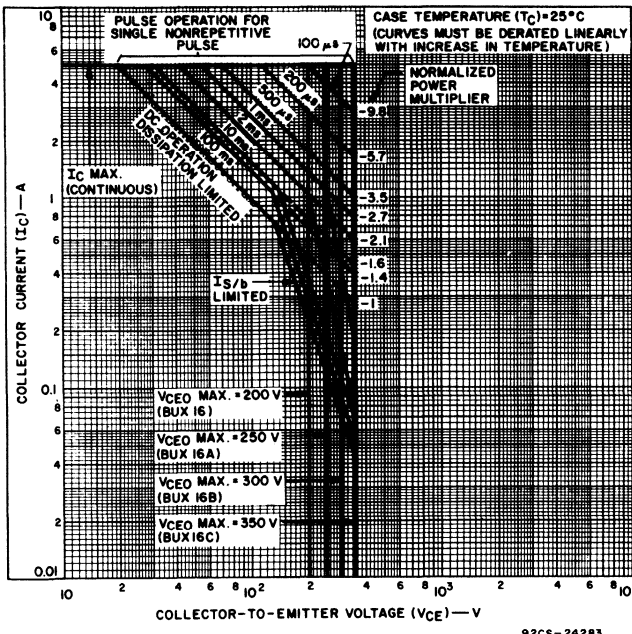


Fig. 1 - Maximum operating areas for all types.

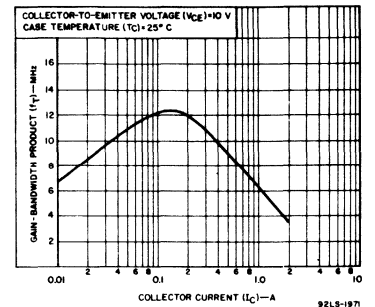


Fig. 3 - Typical gain-bandwidth product vs. collector current for all types.

BUX16, BUX16A, BUX16B, BUX16C

ELECTRICAL CHARACTERISTICS, At Case Temperature (T_C) = 25°C unless otherwise specified

CHARACTERISTIC	SYMBOL	TEST CONDITIONS				LIMITS								UNITS	
		VOLTAGE V dc		CURRENT A dc		BUX16		BUX16A		BUX16B		BUX16C			
		V_{CE}	V_{BE}	I_C	I_B	Min.	Max.	Min.	Max.	Min.	Max.	Min.	Max.		
Collector Cutoff Current: With base reverse-biased	I_{CEV}	250	-1.5	-	-	-	5	-	-	-	-	-	-	mA	
		325	-1.5	-	-	-	-	-	5	-	-	-	-		
		375	-1.5	-	-	-	-	-	-	-	2	-	-		-
		425	-1.5	-	-	-	-	-	-	-	-	-	2		-
With base reverse-biased $T_C = 150^\circ\text{C}$	I_{CEV}	250	-1.5	-	-	-	8	-	8	-	3	-	3	mA	
With base open	I_{CEO}	175	-	-	0	-	5	-	2	-	-	-	-		
		250	-	-	0	-	-	-	-	-	5	-	2		
Emitter Cutoff Current: $V_{EB} = 5\text{ V}$	I_{EBO}	-	-	0	-	-	5	-	5	-	2	-	2	mA	
Collector-to-Emitter Sustaining Voltage ^a With base open	$V_{CEO(sus)}$	-	-	0.2	0	200	-	250	-	300	-	350	-	V	
With external base-to-emitter resistance ($R_{BE} \leq 50\ \Omega$)	$V_{CER(sus)}$	-	-	0.2	-	225	-	300	-	350	-	400	-	V	
Emitter-to-Base Voltage	V_{EBO}	-	-	0	0.02	6	-	6	-	6	-	6	-	V	
DC Forward-Current Transfer Ratio	h_{FE}	10	-	0.4 ^b	-	15	130	15	130	15	130	15	130		
		10	-	2 ^b	-	15	-	15	-	12	-	12	-		
		10	-	4.5 ^b	-	5	-	5	-	5	-	5	-		
Base-to-Emitter Voltage	V_{BE}	10	-	2 ^b	-	-	3	-	3	-	3	-	3	V	
Collector-to-Emitter Saturation Voltage	$V_{CE(sat)}$	-	-	2 ^b	0.25	-	2.5	-	2.5	-	2.5	-	2.5	V	
		-	-	4.5 ^b	1.125	-	5	-	5	-	5	-	5		
Gain-Bandwidth Product	f_T	10	-	0.2	-	5	-	5	-	5	-	5	-	MHz	
Magnitude of Common-Emitter, Small-Signal, Short-Circuit, Forward-Current Transfer Ratio ^c (at 1 MHz)	$ h_{fe} $	10	-	0.2	-	5	-	5	-	5	-	5	-		
Common-Emitter, Small-Signal, Short-Circuit, Forward-Current Transfer Ratio (at 1 kHz)	h_{fe}	10	-	4	-	20	-	20	-	20	-	20	-		
Output Capacitance (at 1 MHz): $V_{CB} = 10\text{ V}$, $I_E = 0$	C_{obo}	-	-	-	-	-	150	-	150	-	150	-	150	pF	
Second-Breakdown Collector Current ^d : (With base forward-biased) Pulse duration (nonrepetitive) = 1 s	$I_{S/b}$	135	-	-	-	0.75	-	0.75	-	0.75	-	0.75	-	A	
Second-Breakdown Energy ^e : (With base reverse-biased) $L = 150\ \mu\text{H}$, $R_{BE} = 50\ \Omega$	$E_{S/b}$	-	-4	4	-	1.2	-	1.2	-	1.2	-	1.2	-	mJ	
Thermal Resistance: Junction-to-case	$R_{\theta JC}$	-	-	-	-	-	1.75	-	1.75	-	1.75	-	1.75	$^\circ\text{C/W}$	

^a CAUTION: Sustaining voltages $V_{CEO(sus)}$ and $V_{CER(sus)}$ MUST NOT be measured on a curve tracer.^b Pulsed, pulse duration $\leq 350\ \mu\text{s}$, duty factor = 2%.^c Measured at a frequency where $|h_{fe}|$ is decreasing at approximately 8 dB per octave.^d $I_{S/b}$ is defined as the current at which second breakdown occurs at a specified collector voltage with the emitter-base junction forward biased for transistor operation in the active region.^e $E_{S/b}$ is defined as the energy at which second breakdown occurs under specified reverse bias connections.
 $E_{S/b} = \frac{1}{2} L I^2$ where L is a series load or leakage inductance, and I is the peak collector current.

BUX16, BUX16A, BUX16B, BUX16C

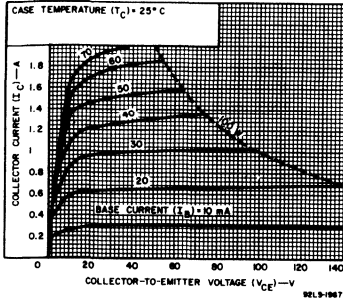


Fig. 4 - Typical output characteristics for all types.

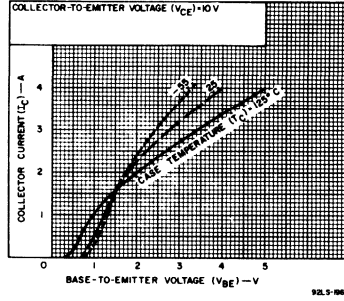


Fig. 5 - Typical transfer characteristics for all types.

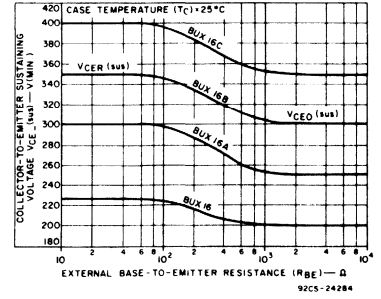


Fig. 6 - Sustaining voltage vs base-to-emitter resistance for all types.

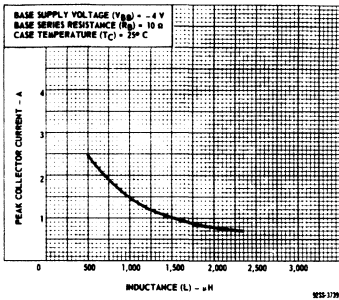


Fig. 7 - Typical reverse-bias, second-breakdown characteristic for all types.

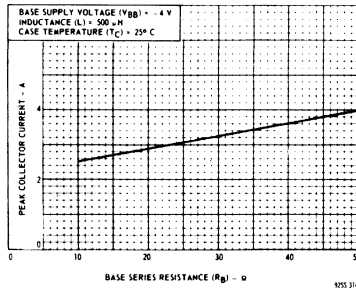


Fig. 8 - Typical reverse-bias, second-breakdown characteristic for all types.

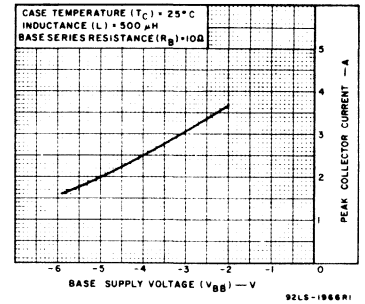


Fig. 9 - Typical reverse bias, second-breakdown characteristic for all types.

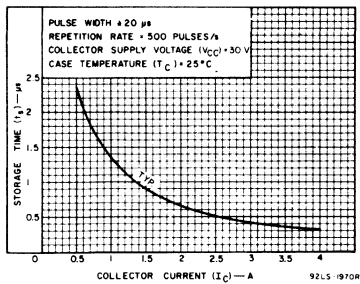


Fig. 10 - Saturated switching time (storage) vs. collector current for all types.

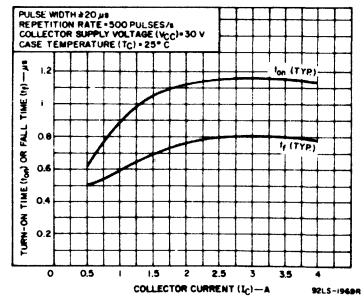


Fig. 11 - Saturated switching times (turn-on and fall) vs. collector current for all types.

BUX17, BUX17A, BUX17B, BUX17C

Silicon N-P-N Switching Transistors

For Switching Applications in Industrial and Commercial Equipment

The RCA-BUX17, BUX17A, BUX17B, and BUX17C are multiple epitaxial silicon n-p-n power transistors utilizing a multiple-emitter-site structure. Multiple-epitaxial construction maximizes the volt-ampere characteristic of the device and provides fast switching speeds. Multiple-emitter-site design assures uniform current flow throughout the structure, which produces a high $I_{S/B}$ and a large safe-operation area.

These devices use the popular JEDEC TO-3 package; they differ mainly in voltage ratings and leakage-current limits.

The exceptional second-breakdown capabilities and high voltage-breakdown ratings make these transistors especially suitable for off-line inverters, switching regulators, motor controls, and deflection-circuit applications.

The high breakdown voltages, low saturation voltages, and fast-switching capability of these devices make them especially suitable for inverter circuits operating directly off the rectified 115-V power line or in a bridge configuration operating from the rectified 220-V line.

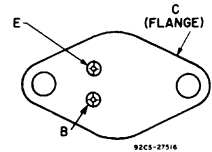
Features:

- High voltage ratings:
 $V_{CBO} = 250$ V (BUX17)
 $= 350$ V (BUX17A)
 $= 400$ V (BUX17B)
 $= 450$ V (BUX17C)
- High dissipation rating: $P_T = 150$ W
- Low saturation voltages
- Maximum safe-area-of-operation curves

MAXIMUM RATINGS, Absolute-Maximum Values:

	BUX17	BUX17A	BUX17B	BUX17C
COLLECTOR-TO-BASE VOLTAGE	250	350	400	450
COLLECTOR-TO-EMITTER SUSTAINING VOLTAGE:				
With base open	$V_{CE0(sus)}$	150	250	300
With reverse bias ($V_{BE} = 0$ V (with base-emitter shorted))	$V_{CEX(sus)}$	250	350	400
With external base-to-emitter resistance ($R_{BE} \leq 50 \Omega$)	$V_{CER(sus)}$	175	275	325
EMITTER-TO-BASE VOLTAGE	V_{EBO}	6	6	6
COLLECTOR CURRENT:				
Continuous	I_C	10	10	10
Peak	I_{CM}	30	30	30
CONTINUOUS BASE CURRENT	I_B	10	10	10
TRANSISTOR DISSIPATION:	P_T	150	150	150
At case temperatures up to 25°C and V_{CE} up to 30 V				
At case temperatures up to 25°C and V_{CE} above 30 V				
At case temperatures above 25°C				
TEMPERATURE RANGE:				
Storage & Operating (Junction)				
PIN TEMPERATURE (During soldering):				
At distances $\geq 1/32$ in. (0.8 mm) from case for 10 s max.				

TERMINAL DESIGNATIONS



JEDEC TO-3

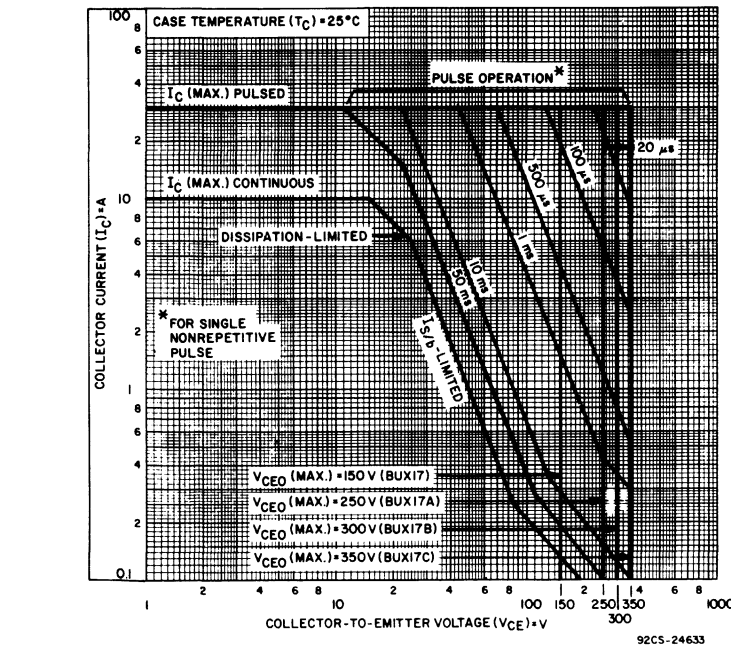


Fig. 1 - Maximum operating areas for all types.

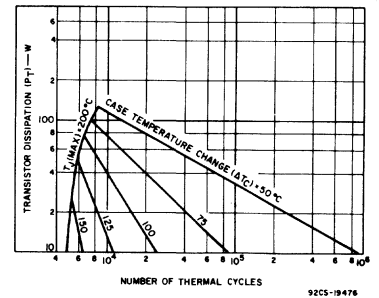


Fig. 2 - Thermal-cycling rating chart for all types.

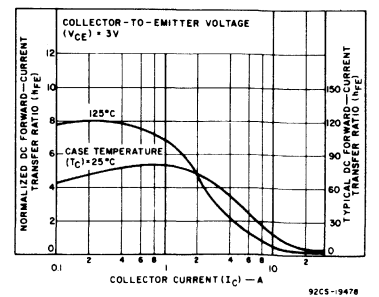


Fig. 3 - Typical normalized dc beta characteristics for all types.

BUX17, BUX17A, BUX17B, BUX17C

ELECTRICAL CHARACTERISTICS, At Case Temperature (T_C) = 25°C unless otherwise specified

CHARACTERISTIC	SYMBOL	TEST CONDITIONS				LIMITS								UNITS
		VOLTAGE V dc		CURRENT A dc		BUX17		BUX17A		BUX17B		BUX17C		
		V_{CE}	V_{BE}	I_C	I_B	Min.	Max.	Min.	Max.	Min.	Max.	Min.	Max.	
Collector Cutoff Current: With external base-to-emitter resistance (R_{BE}) = 50 Ω	I_{CER}	175				–	10	–	–	–	–	–	–	mA
		275				–	–	–	10	–	–	–		
		325				–	–	–	–	10	–	–		
		375				–	–	–	–	–	10	–		
With base-emitter junction reverse-biased	I_{CEV}	250	–1.5			–	10	–	–	–	–	–	mA	
		350	–1.5			–	–	–	10	–	–	–		
		400	–1.5			–	–	–	–	5	–	–		
		450	–1.5			–	–	–	–	–	5	–		
At $T_C = 125^\circ\text{C}$		250	–1.5			–	20	–	–	–	–	–	mA	
350	–1.5			–	–	–	20	–	–	–				
400	–1.5			–	–	–	–	10	–	–				
450	–1.5			–	–	–	–	–	10	–				
Emitter Cutoff Current	I_{EBO}		–6	0		–	2	–	2	–	2	–	2	mA
DC Forward-Current Transfer Ratio	h_{FE}	3		4 ^a		20	–	20	–	15	–	15	–	
		3		8		–	–	–	–	7	–	7	–	
		3		10 ^a		7	–	–	–	–	–	–	–	
Collector-to-Emitter Sustaining Voltage With base open	$V_{CE0(sus)}$			0.2 ^a		150 ^b	–	250 ^b	–	300 ^b	–	350 ^b	–	V
				0.2 ^a		175 ^b	–	275 ^b	–	325 ^b	–	375 ^b	–	
With external base-to-emitter resistance (R_{BE}) = 50 Ω	$V_{CER(sus)}$			0.2 ^a		175 ^b	–	275 ^b	–	325 ^b	–	375 ^b	–	V
Base-to-Emitter Voltage	V_{BE}	3		8 ^a		–	–	–	–	–	3.5	–	3.5	V
		3		10 ^a		–	4	–	4	–	–	–	–	
Base-to-Emitter Saturation Voltage	$V_{BE(sat)}$			8 ^a	1.5	–	–	–	–	–	2	–	2	V
				10 ^a	2	–	3	–	3	–	–	–	–	
Collector-to-Emitter Saturation Voltage	$V_{CE(sat)}$			8 ^a	1.5	–	–	–	–	–	3	–	3	V
				10 ^a	2	–	2	–	2	–	–	–	–	
Magnitude of Common-Emitter, Small-Signal, Short-Circuit, Forward-Current Transfer Ratio: $f = 1$ MHz	$ h_{fe} $	10		1		2.5	8	2.5	8	2	8	2.5	8	
Forward-bias Second Breakdown Collector Current: $t = 1$ s, nonrepetitive	$I_{S/b}$	25				6	–	6	–	6	–	6	–	A
Second-Breakdown Energy: With base reverse-biased, and $R_{BE} = 50 \Omega$, $L = 40 \mu\text{H}$	$E_{S/b}$		–4	10		2	–	2	–	2	–	2	–	mJ
Saturated Switching Time ($V_{CC} =$ 200 V, $I_{B1} = I_{B2}$): Turn-on ($t_d + t_r$)	t_{ON}			8	1.5	–	–	–	–	–	2	–	2	μs
				10	2	–	2	–	2	–	–	–	–	
Storage	t_s			8	1.5	–	–	–	–	–	3.5	–	3.5	μs
Fall	t_f			8	1.5	–	–	–	–	–	1	–	1	
				10	2	–	3.5	–	3.5	–	–	–	–	
Thermal Resistance: Junction-to-Case	$R_{\theta JC}$					–	1.17	–	1.17	–	1.17	–	1.17	$^\circ\text{C/W}$

^aPulsed; pulse duration $\leq 350 \mu\text{s}$, duty factor = 2%.^bCAUTION: The sustaining voltages $V_{CE0(sus)}$ and $V_{CER(sus)}$ MUST NOT be measured on a curve tracer.

BUX17, BUX17A, BUX17B, BUX17C

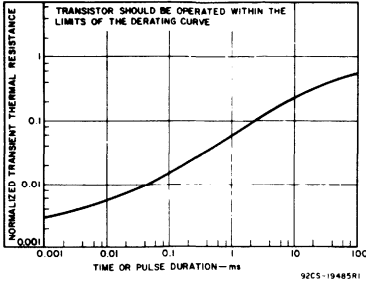


Fig. 4 - Typical thermal response characteristics for all types.

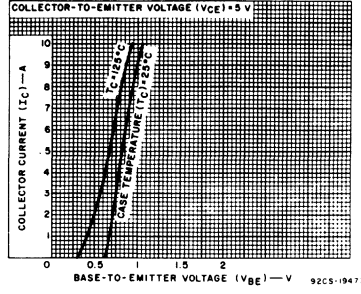


Fig. 5 - Typical transfer characteristics for all types.

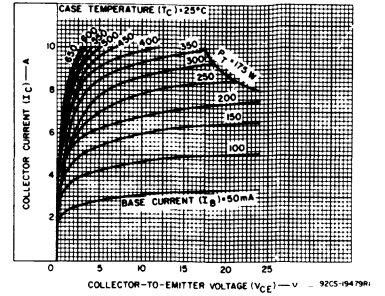


Fig. 6 - Typical output characteristics for all types.

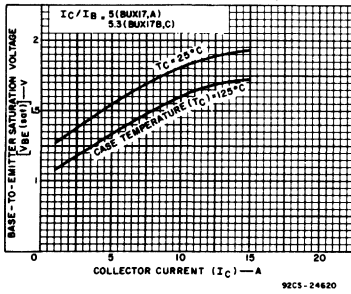


Fig. 7 - Typical base-to-emitter saturation-voltage characteristics for all types.

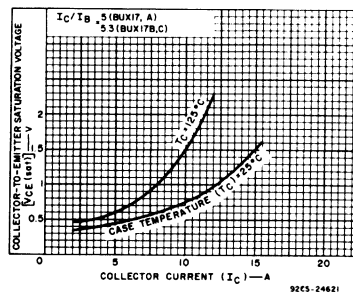


Fig. 8 - Typical collector-to-emitter saturation-voltage characteristics for all types.

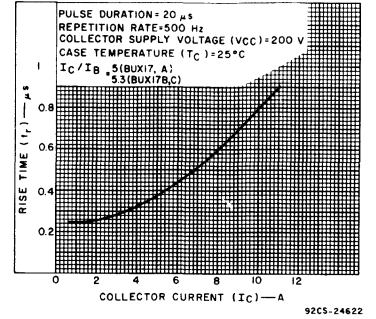


Fig. 9 - Typical rise-time characteristics for all types.

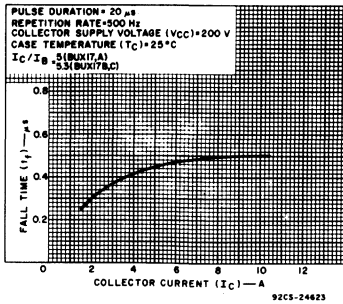


Fig. 10 - Typical fall-time characteristic for all types.

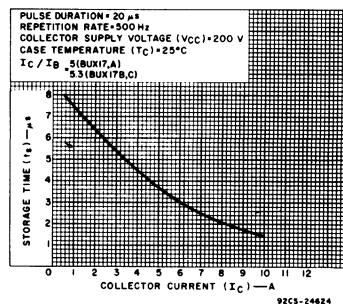


Fig. 12 - Typical inductive- and resistive-load fall-time characteristics for all types.

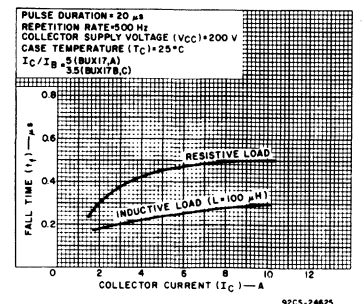


Fig. 11 - Typical storage-time characteristics for all types (with constant forced gain).

BUX18, BUX18A, BUX18B, BUX18C

High-Voltage, High-Current Silicon N-P-N Power-Switching Transistors

For Off-Line Switching Applications

The RCA-BUX18, BUX18A, BUX18B, and BUX18C are epitaxial silicon n-p-n power-switching transistors with pi-nu construction. They are intended for use in off-line power supplies and for other applications in which a combination of high-

current-handling capability, ruggedness, and fast switching speed is required. The devices are hermetically sealed in a steel JEDEC TO-3 package, and differ from each other in collector voltage ratings.

MAXIMUM RATINGS, Absolute Maximum Values:

	BUX18	BUX18A	BUX18B	BUX18C		
COLLECTOR-TO-EMITTER SUSTAINING VOLTAGES:						
With reverse bias, $V_{BE} = -1.5$ V	$V_{CEV(sus)}$	300	450	600	750	V
With external base-to-emitter resistance ($R_{BE} = 100\Omega$)	$V_{CER(sus)}$	250	325	375	425	V
With base open	$V_{CEO(sus)}$	200	275	325	375	V
EMITTER TO BASE VOLTAGE						
	V_{EBO}	6	6	6	6	V
CONTINUOUS COLLECTOR CURRENT						
	I_C	8	8	8	8	A
PEAK COLLECTOR CURRENT						
	I_{CM}	12	12	12	12	A
CONTINUOUS BASE CURRENT						
	I_B	2	2	2	2	A
PEAK BASE CURRENT						
	I_{BM}	3	3	3	3	A
TRANSISTOR DISSIPATION						
At case temperatures up to 25°C	P_T	120	120	120	120	W
At case temperatures above 25°C		Derate linearly at 0.68 W/°C				°C
TEMPERATURE RANGE						
Storage and Operating (Junction)		65 to +200				°C
LEAD TEMPERATURE (During Soldering)						
At distances $\geq 1/32$ in. (0.8 mm) from case for 10 s max.		235				°C

Features:

- Fast switching speed
- Hermetic steel package—JEDEC TO-3
- Epitaxial pi-nu construction

TERMINAL DESIGNATIONS

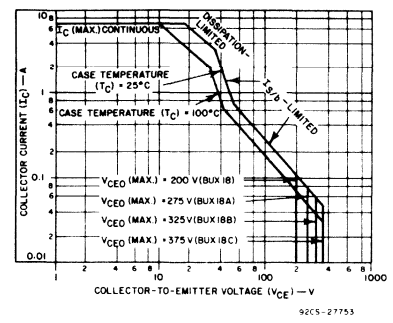
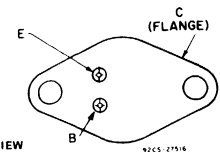


Fig. 2 Maximum operating areas for all types at 25°C and 100°C.

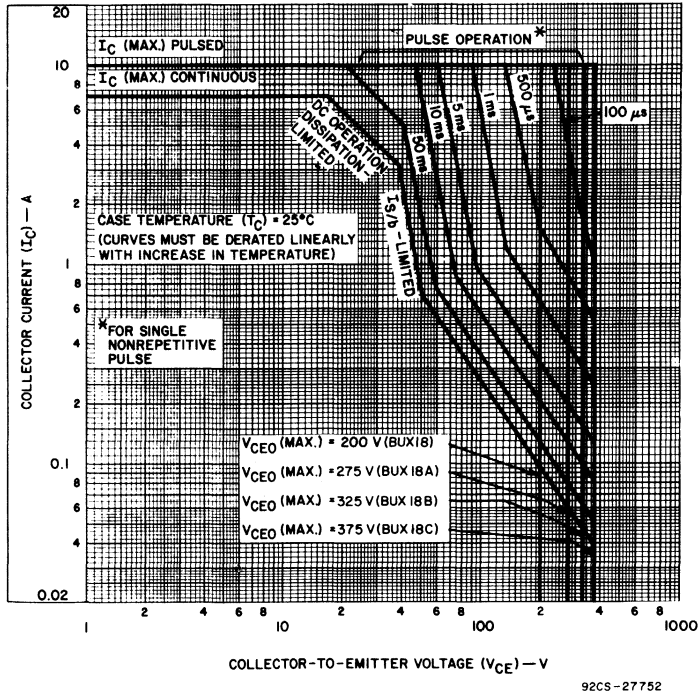


Fig. 1 — Maximum operating areas for all types.

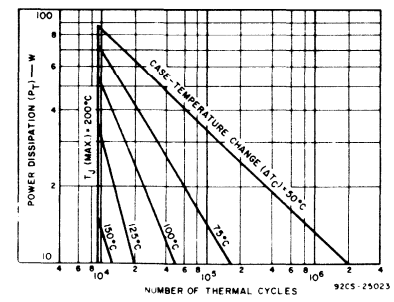


Fig. 3 — Thermal-cycling rating chart for all types.

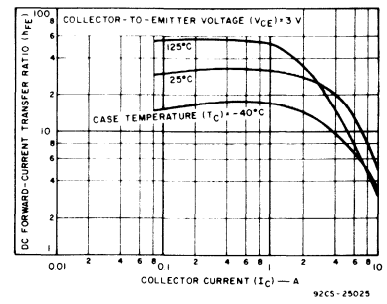


Fig. 4 — Typical dc beta characteristic for all types.

BUX18, BUX18A, BUX18B, BUX18C

ELECTRICAL CHARACTERISTICS, At Case Temperature $(T_C) = 25^\circ\text{C}$ unless otherwise specified.

CHARACTERISTIC	SYMBOL	TEST CONDITIONS				LIMITS				UNITS					
		VOLTAGE V dc		CURRENT A dc		BUX18		BUX18A			BUX18B		BUX18C		
		V_{CE}	V_{BE}	I_C	I_B	Min.	Max.	Min.	Max.		Min.	Max.	Min.	Max.	
Collector Cutoff Current: With external base-to-emitter resistance (R_{BE}) = 100 Ω	I_{CER}	200				—	3	—	—	—	—	—	—		
		275				—	—	—	3	—	—	—	—		
		325				—	—	—	—	3	—	—	—		
With base-to-emitter junction reverse-biased	I_{CEV}	300	-1.5			—	0.5	—	—	—	—	—	—		
		450	-1.5			—	—	—	0.5	—	—	—	—		
		600	-1.5			—	—	—	—	0.5	—	—	—		
		750	-1.5			—	—	—	—	—	—	0.5	—		
With base-to-emitter junction reverse-biased, and $T_C = 100^\circ\text{C}$	I_{CEV}	300	-1.5			—	10	—	—	—	—	—	—		
		450	-1.5			—	—	—	10	—	—	—	—		
		600	-1.5			—	—	—	—	10	—	—	—		
		750	-1.5			—	—	—	—	—	10	—	—		
Emitter Cutoff Current	I_{EBO}		-6	0		—	3	—	3	—	3	—	mA		
Emitter Cutoff Voltage	V_{EBO}			0	0.003	6	—	6	—	6	—	6	V		
DC Forward-Current Transfer Ratio	h_{FE}	3		4 ^a		—	—	—	10	—	10	—	—		
		3		5 ^a		—	—	—	7	—	—	—	—		
		3		6 ^a		—	—	—	—	—	—	—	—		
		5		1 ^a		15	100	15	100	15	100	15	100		
Collector-to-Emitter Sustaining Voltage: With base open	$V_{CEO(sus)}$			0.2	0	200 ^b	—	275 ^b	—	325 ^b	—	375 ^b	—	V	
		With external base-to-emitter resistance (R_{BE}) = 100 Ω	$V_{CER(sus)}$			0.2	250 ^b	—	325 ^b	—	375 ^b	—	425 ^b	—	
Forward-Biased Second-Break- down Collector Current: $t = 1$ s, nonrepetitive	$I_{S/b}$	38 200				3.16 0.1	—	3.16 0.1	—	3.16 0.1	—	3.16 0.1	—	A	
Base-to-Emitter Saturation Voltage	$V_{BE(sat)}$			6 ^a 5 ^a 4 ^a	1.2 1 0.8	—	2.5	—	—	—	—	—	—	V	
Collector-to-Emitter Saturation Voltage	$V_{CE(sat)}$			6 ^a 5 ^a 4 ^a	1.2 1 0.8	—	1.5	—	—	1.5	—	—	—	V	
Reverse-Bias Second-Breakdown Energy: $R_{BE} = 3$ k Ω , $L = 40$ μH	$E_{S/b}$		-1.5	3		180	—	180	—	180	—	180	—	mJ	
Saturated Switching Time ($I_{B1} = I_{B2}$): Storage	t_s	$V_{CC} = 200$ V		4	0.8	—	2	—	2	—	2	—	2	—	μs
			Fall	t_f	$V_{CC} = 200$ V	4	0.8	—	0.6	—	0.6	—	0.6	—	0.6
Thermal Resistance: Junction-to-Case	$R_{\theta JC}$					—	1.46	—	1.46	—	1.46	—	1.46	$^\circ\text{C/W}$	

^a Pulsed, pulse duration = 300 μs , duty factor $\leq 2\%$.

^b CAUTION: Sustaining Voltages $V_{CEO(sus)}$ and $V_{CER(sus)}$, MUST NOT be measured on a curve tracer.

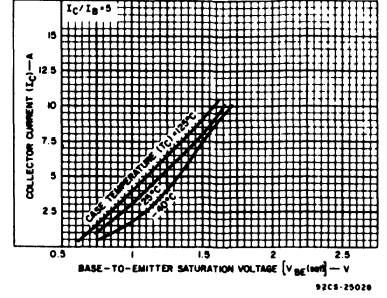


Fig. 5 – Typical collector-to-emitter saturation-voltage characteristics for all types.

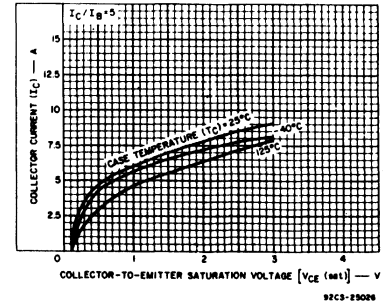


Fig. 6 – Typical base-to-emitter saturation-voltage characteristics for all types.

BUX66, BUX66A, BUX66B, BUX66C, BUX67, BUX67A, BUX67B, BUX67C

High-Voltage Silicon N-P-N and P-N-P Transistors

For High-Speed Switching and Linear-Amplifier Applications

The RCA-BUX66-series types are silicon p-n-p transistors; the RCA-BUX67-series types are silicon n-p-n transistors. All of these devices feature high breakdown voltage and fast switching speeds. They are intended for a wide variety of applications in ac/dc commercial equipment.

Typical applications include high-voltage operational and linear amplifiers, high-voltage

switches, switching regulators, converters, and inverters.

The BUX66, BUX66A, BUX66B, and BUX66C are p-n-p complements to the n-p-n types BUX67, BUX67A, BUX67B, and BUX67C. All are supplied in the JEDEC TO-66 hermetic package.

Features:

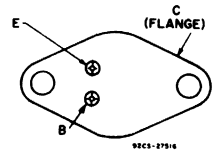
- High voltage ratings:
- Large safe-operating area
- Thermal-cycling rating
- 100-percent tested to assure freedom from second breakdown in both forward- and reverse-bias conditions when operated within specified limits
- Economy types for ac/dc circuits
- Fast turn-on time at high collector current

MAXIMUM RATINGS, Absolute-Maximum Values:

	BUX66 [♦] BUX67	BUX66A [♦] BUX67A	BUX66B [♦] BUX67B	BUX66C [♦] BUX67C	
V _{CBO}	200	300	350	400	V
V _{CEV(sus)}					
V _{BE} = -1.5 V	200	300	350	400	V
V _{CER(sus)}					
R _{BE} = 100 Ω	175	275	325	375	V
V _{CEO(sus)}	150	250	300	350	V
V _{EBO}	6	6	6	6	V
I _C	2	2	2	2	A
I _{CM}	5	5	5	5	A
I _B	1	1	1	1	A
P _T					
Up to 25°C	35	35	35	35	W
Above 25°C, Derate linearly	0.2	0.2	0.2	0.2	W/°C
T _J , T _{stg}		-65 to 200			°C
T _L At distance 1/16 in. (1.58 mm) from seating plane for 10 s max.	235	235	235	235	°C

♦ For p-n-p devices, voltage and current values are negative.

TERMINAL DESIGNATIONS



JEDEC TO-66

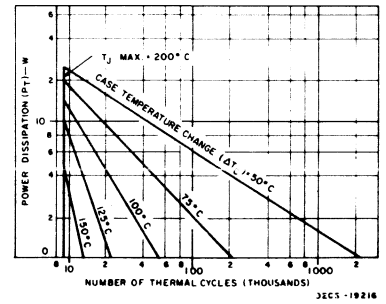


Fig. 1 - Thermal-cycling rating chart for BUX66-series types.

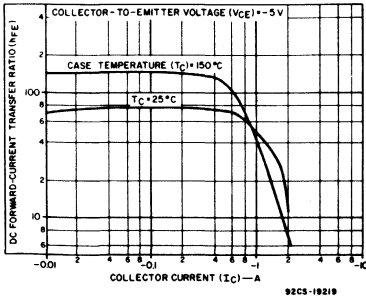


Fig. 2 - Typical dc beta characteristics for BUX66-series types.

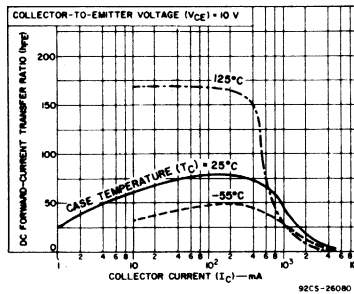


Fig. 3 - Typical dc beta characteristics for BUX67-series types.

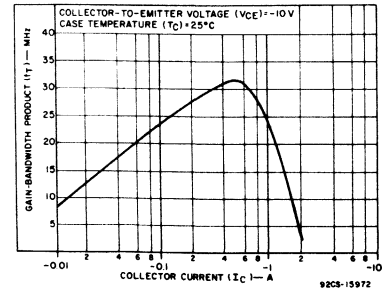


Fig. 4 - Typical gain-bandwidth product for BUX66-series types.

BUX66, BUX66A, BUX66B, BUX66C, BUX67, BUX67A, BUX67B, BUX67C

ELECTRICAL CHARACTERISTICS, At Case Temperature (T_C) = 25°C
Unless Otherwise Specified

CHARACTERISTIC SYMBOL	TEST CONDITIONS [♦]				LIMITS								UNITS
	VOLTAGE V dc		CURRENT A dc		BUX66 [♦] BUX67		BUX66A [♦] BUX67A		BUX66B [♦] BUX67B		BUX66C [♦] BUX67C		
	V _{CE}	V _{BE}	I _C	I _B	Min.	Max.	Min.	Max.	Min.	Max.	Min.	Max.	
I _{CEO}	150			0	—	10	—	10	—	—5	—	—5	mA
I _{CEX}	200	-1.5			—	8	—	—	—	—	—	—	
	300	-1.5			—	—	—	8	—	—	—	—	
	350	-1.5			—	—	—	—	—	-8	—	—	
	400	-1.5			—	—	—	—	—	—	—	-8	
T _C = 100°C	200	-1.5			—	10	—	—	—	—	—	—	
	300	-1.5			—	—	—	10	—	—	—	—	
	350	-1.5			—	10	—	—	—	-10	—	—	
	400	-1.5			—	—	—	10	—	—	—	-10	
I _{EBO}		-6	0		—	1	—	1	—	1	—	1	
h _{FE}	5		1 ^a		10	150	10	150	10	150	10	150	
V _{CEO(sus)}			0.2 ^a	0	150 ^c	—	250 ^c	—	-300 ^c	—	-350 ^c	—	V
V _{CE(sus)} R _{BE} = 50 Ω			0.2		175 ^c	—	275 ^c	—	-325 ^c	—	-375 ^c	—	
V _{BE(sat)}			1 ^a	0.15	—	1.5	—	1.5	—	-1.5	—	-1.5	V
V _{CE(sat)}			1 ^a	0.15	—	2.5	—	2.5	—	-2.5	—	-2.5	V
C _{obo} V _{CB} = 10 V f = 1 MHz BUX67 Types BUX66 Types			0		—	120	—	120	—	220	—	220	pF
			0		—	200	—	200	—	220	—	220	
I _{S/b} t = 1 s, nonrep.	40				875	—	875	—	-875	—	-875	—	mA
E _{S/b} L = 100 μH R _{BE} = 20 Ω			-4		50	—	200	—	200	—	50	—	μJ
h _{fe} f = 5 MHz BUX67 Types BUX66 Types	10 -10		0.2 -0.2		2 4	— —	2 4	— —	2 4	— —	2 4	— —	
t _r V _{CC} = 200 V BUX67 Types BUX66 Types			1 -1	0.1 ^b -0.10 ^b	— —	3 0.6	— —	3 0.6	— —	3 0.6	— —	3 0.6	μs
t _s V _{CC} = 200 V BUX67 Types BUX66 Types			1 -1	0.1 ^b -0.10 ^b	— —	4 2.5	— —	4 2.5	— —	4 2.5	— —	4 2.5	
t _f V _{CC} = 200 V BUX67 Types BUX66 Types			1 -1	0.1 ^b -0.10 ^b	— —	3 0.6	— —	3 0.6	— —	3 0.6	— —	3 0.6	
R _{θJC}						5	—	5	—	5	—	5	°C/W

^a Pulsed: Pulse duration = 300 μs; duty factor ≤ 2%. ^b I_{B1} = I_{B2} [♦] For p-n-p devices, voltage and current values are negative.
^c Sustaining voltages. V_{CEO(sus)} and V_{CE(sus)} MUST NOT be measured on a curve tracer.

BUX66, BUX66A, BUX66B, BUX66C, BUX67, BUX67A, BUX67B, BUX67C

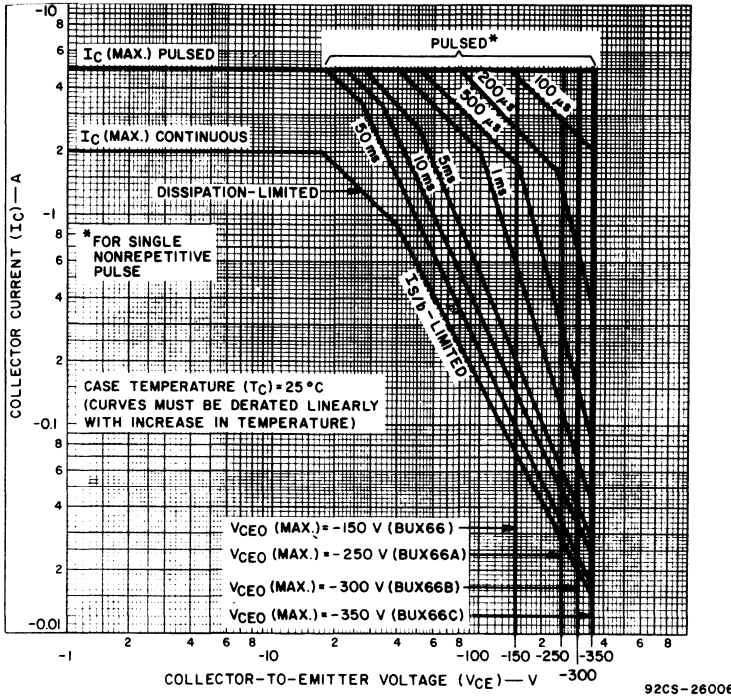


Fig. 5 — Maximum operating areas for BUX66-series types.

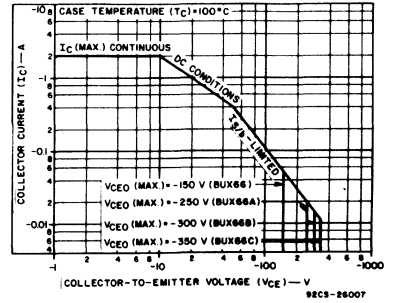


Fig. 7 — Maximum operating areas for BUX66-series at $T_C = 100^\circ\text{C}$.

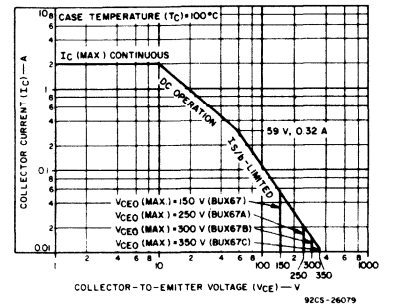


Fig. 8 — Maximum operating areas for BUX67-series at $T_C = 100^\circ\text{C}$.

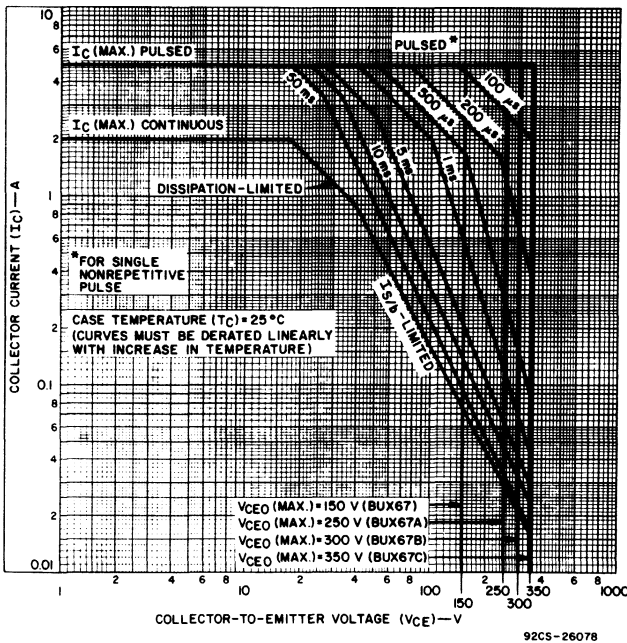


Fig. 6 — Maximum operating areas for BUX67-series types at $T_C = 25^\circ\text{C}$.

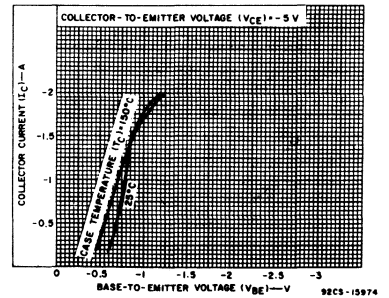


Fig. 9 — Typical transfer characteristics for BUX66-series types.

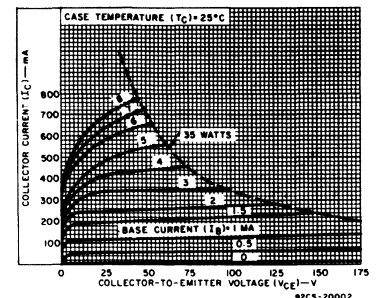


Fig. 10 — Typical output characteristics for BUX67-series types.

BUX66, BUX66A, BUX66B, BUX66C, BUX67, BUX67A, BUX67B, BUX67C

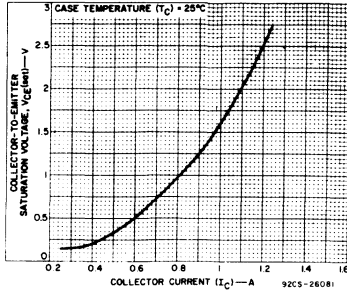


Fig. 11 — Typical saturation-voltage characteristic for BUX67-series types.

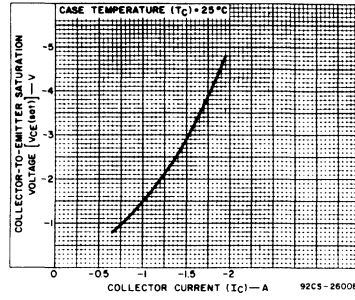


Fig. 12 — Typical saturation-voltage characteristic for BUX66-series types.

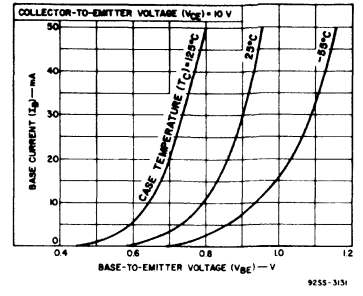


Fig. 13 — Typical input characteristics for BUX67-series types.

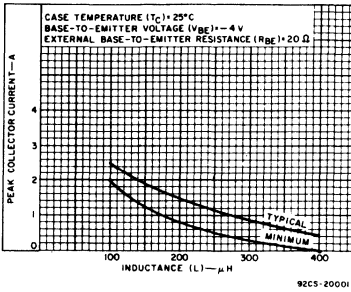


Fig. 14 — Reverse-bias second-breakdown characteristics for BUX67-series types.

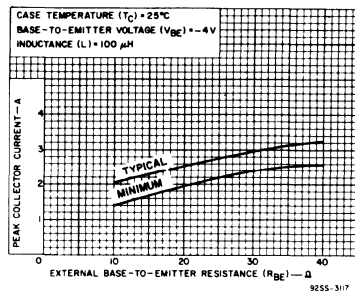


Fig. 15 — Reverse-bias second-breakdown characteristics for BUX67-series types.

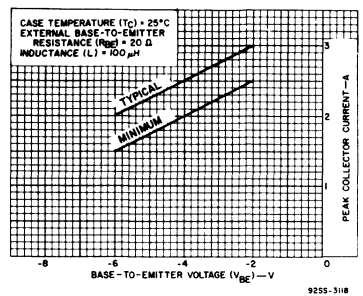


Fig. 16 — Reverse-bias second-breakdown characteristics for BUX67-series types.

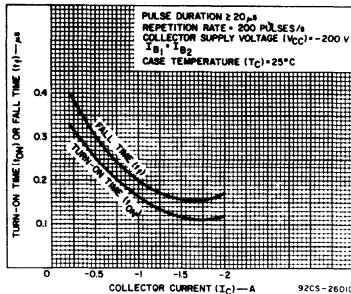


Fig. 17 — Typical turn-on time and fall-time characteristics for BUX66-series types.

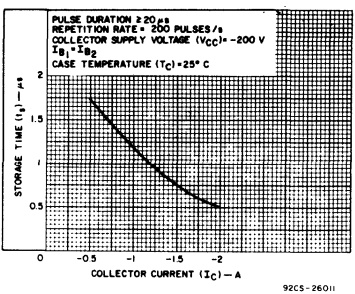


Fig. 18 — Typical storage-time characteristic for BUX66-series types.

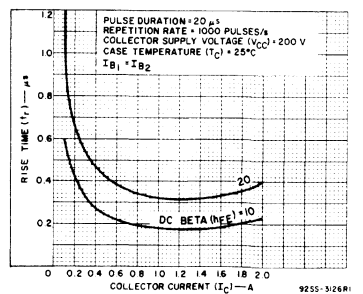


Fig. 19 — Typical rise time vs. collector current for BUX67-series types.

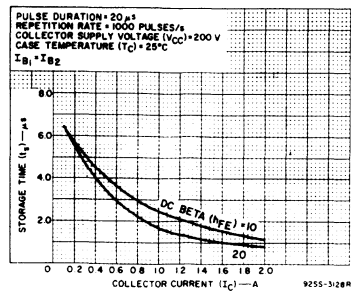


Fig. 20 — Typical storage time vs. collector current for BUX67-series types.

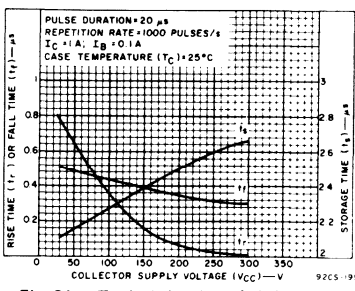


Fig. 21 — Typical rise time, fall time, and storage time vs. collector supply voltage for BUX67-series types.

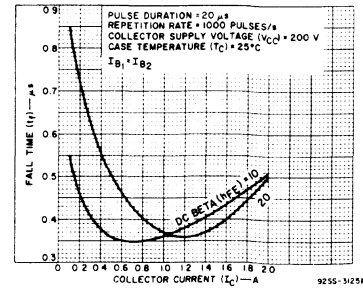


Fig. 22 — Typical fall time vs. collector current for BUX67-series types.

MJ15001, MJ15002

Complementary N-P-N/P-N-P Silicon Power Transistors

Rugged Devices, Broadly Applicable For Industrial and Commercial Use

The RCA-MJ15001 and MJ15002 are ballasted epitaxial-base silicon transistors featuring high gain at high current. The

MJ15001 n-p-n transistor complements the MJ15002 p-n-p transistor. These types are supplied in the JEDEC TO-204MA packages.

MAXIMUM RATINGS, Absolute-Maximum Values:

	MJ15001	MJ15002	
V_{CBO}	140	-140	V
V_{CEO}	140	-140	V
V_{EBO}	5	-5	V
I_C	15	-15	A
I_B	5	-5	A
I_E	20	-20	A
P_T			W
At $T_C \geq 25^\circ C$	200	-200	$W/^\circ C$
At $T_C > 25^\circ C$		1.14	$^\circ C$
T_{stg}, T_J		-65 to 200	$^\circ C$
T_L			$^\circ C$
At distance $\geq 1/32$ in. (0.8 mm) from seating plane for 10 s max.		230	$^\circ C$

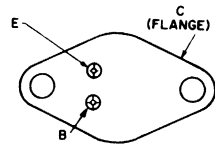
Features:

- High-dissipation capability
- Low saturation voltages
- Maximum safe-area-of-operation curves
- $f_T = 2$ MHz
- High gain at high current

Applications:

- Series and shunt regulators
- High-fidelity amplifiers
- Power-switching circuits
- Solenoid drivers

TERMINAL DESIGNATIONS



JEDEC TO-204MA

ELECTRICAL CHARACTERISTICS, at Case Temperature (T_C) = 25°C Unless Otherwise Specified

CHARACTERISTICS	TEST CONDITIONS				LIMITS				UNITS
	VOLTAGE		CURRENT		MJ15001		MJ15002		
	V_{CE}	V_{BE}	I_C	I_B	Min.	Max.	Min.	Max.	
I_{CEX}	140	1.5			-	1	-	-1	mA
$T_C = 150^\circ C$	140	1.5			-	2	-	-2	
I_{CEO}	140			0	-	2.5	-	-2.5	mA
I_{EBO}		5	0		-	1	-	-1	mA
$V_{CEO(sus)}^a$			0.2	0	140	-	-140	-	V
h_{FE}^a	2	4			25	150	25	150	
V_{BE}	2	4			-	2	-	-2	V
$V_{CE(sat)}$		4	0.4		-	1	-	-1	V
f_T $f = 0.5$ MHz	10		0.5		2	-	2	-	MHz
$I_{S/b}$ $tp = 1s$	40				5	-	-5	-	A
	100				0.5	-	-0.5	-	
C_{ob} $V_{CB} = 10$ V $f = 1$ MHz					-	1000	-	1000	pF
$R_{\theta JC}$					-	0.875	-	0.875	$^\circ C/W$

^a CAUTION: Sustaining voltage, $V_{CEO(sus)}$, MUST NOT be measured on a curve tracer.

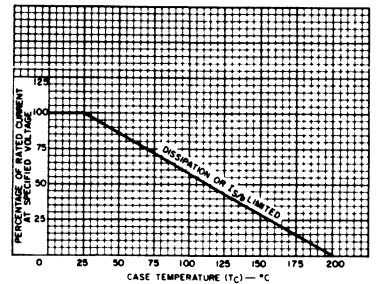


Fig. 1 - Current derating curve for both types.

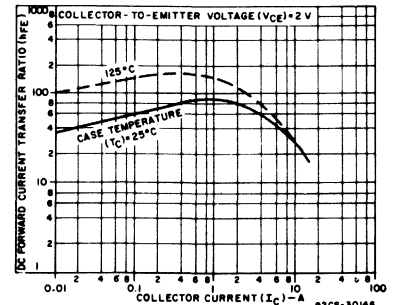


Fig. 2 - Typical dc beta characteristics as a function of collector current for MJ15001.

MJ15001, MJ15002

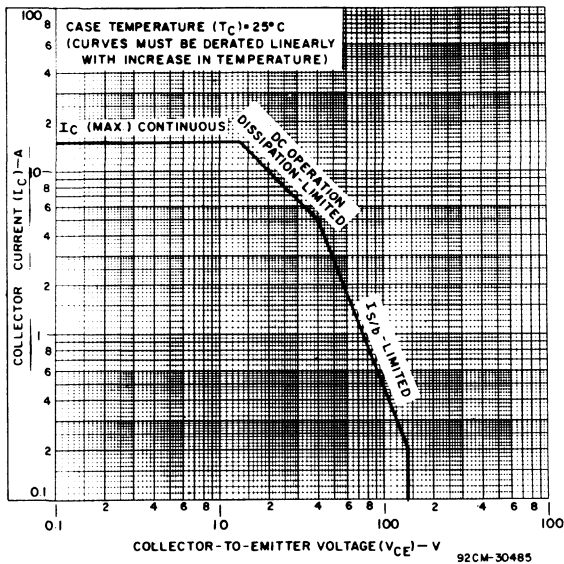


Fig. 3 – Maximum operating area for both types.

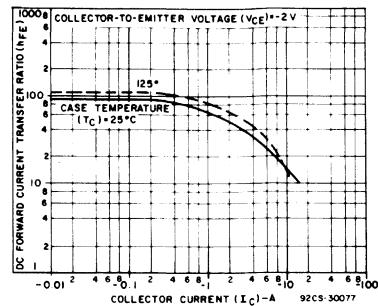


Fig. 4 – Typical dc beta characteristics as a function of collector current for MJ15002.

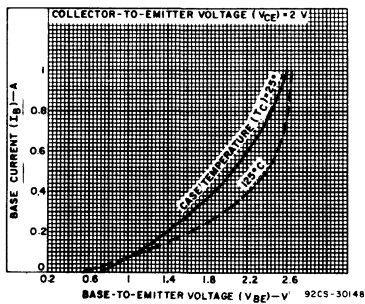


Fig. 5 – Typical input characteristics for MJ15001.

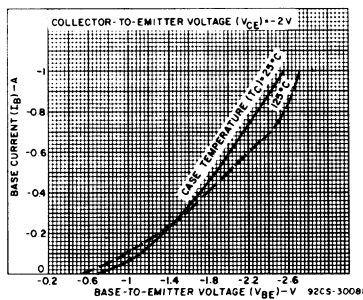


Fig. 6 – Typical input characteristics for MJ15002.

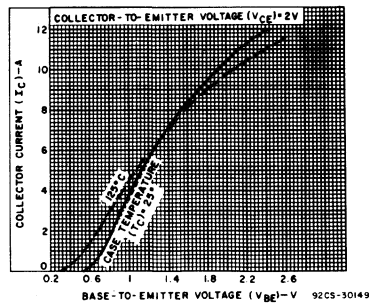


Fig. 7 – Typical transfer characteristics for MJ15001.

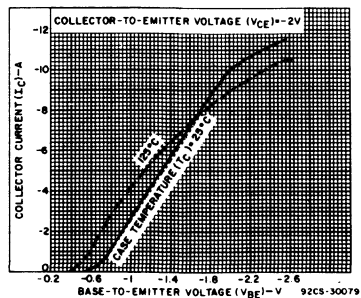


Fig. 8 – Typical transfer characteristics for MJ15002.

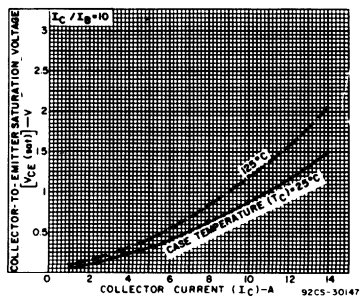


Fig. 9 – Typical saturation voltage characteristics for MJ15001.

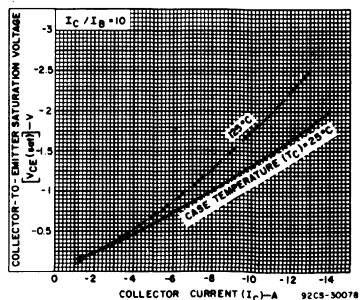


Fig. 10 – Typical saturation voltage characteristics for MJ15002.

MJ15003, RCA3773, RCA8638C, RCA8638D, RCA8638E

Silicon N-P-N Epitaxial-Base High-Power Transistors

Rugged Devices, Broadly Applicable For Industrial and Commercial Use

The RCA3773, MJ15003, RCA8638C, RCA8638D, and RCA8638E are ballasted epitaxial-base silicon n-p-n transistors featuring high gain at high current. They may be used as complements to the p-n-p types 2N6609, MJ15004, RCA9116C, RCA9116D, and RCA9116E, respectively.

They differ in voltage ratings and in the currents at which the parameters are controlled. All are supplied in the steel JEDEC TO-204MA packages.

Features:

- High-dissipation capability
- Low saturation voltages
- Maximum safe-area-of-operation curves
- $f_T = 2$ MHz
- High gain at high current

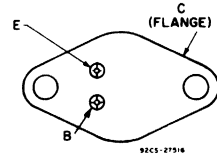
Applications:

- Series and shunt regulators
- High-fidelity amplifiers
- Power-switching circuits
- Solenoid drivers

MAXIMUM RATINGS, Absolute-Maximum Values:

	RCA3773	MJ15003	RCA8638C	RCA8638D	RCA8638E	
V_{CBO}	160	140	140	120	100	V
$V_{CEX}^{(sus)}$						
$V_{BE} = -1.5$ V; $R_{BE} = 100 \Omega$	160	—	—	—	—	V
$V_{CER}^{(sus)}$						
$R_{BE} = 100 \Omega$	150	150	150	130	110	V
$V_{CEO}^{(sus)}$	140	140	140	120	100	V
V_{EBO}	7	—	5	—	—	V
I_C	—		20		—	A
I_B	—		5		—	A
P_T						W
At $T_C \leq 25^\circ C$	150	250	200	200	200	$W/^\circ C$
At $T_C > 25^\circ C$ Derate linearly	0.857	1.43	—	1.14	—	$W/^\circ C$
T_{stg} ; T_J	—		-65 to 200		—	$^\circ C$
T_L	—		230		—	$^\circ C$
At distance $\geq 1/32$ in. (0.8 mm) from seating plane for 10 s max.						

TERMINAL DESIGNATIONS



JEDEC TO-204MA

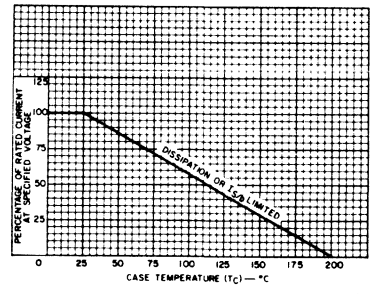


Fig. 2 - Current derating curve for all types.

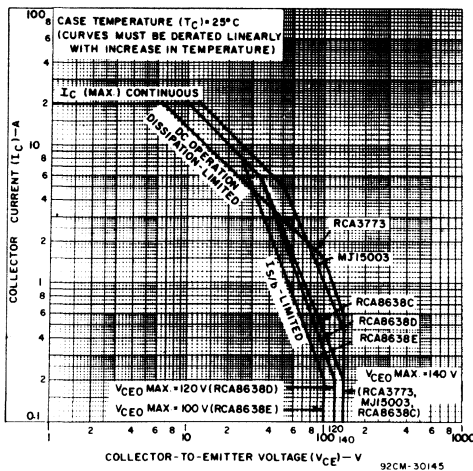


Fig. 1 - Maximum operating areas for all types.

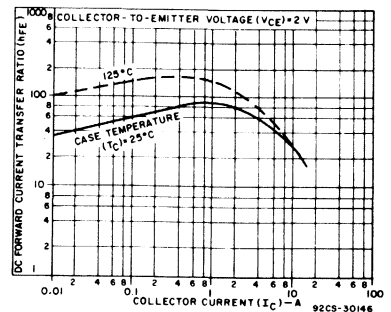


Fig. 3 - Typical dc beta characteristics as a function of collector current for all types.

MJ15003, RCA3773, RCA8638C, RCA8638D, RCA8638E

ELECTRICAL CHARACTERISTICS, at Case Temperature (T_C) = 25°C
 Unless Otherwise Specified (Cont'd)

CHARACTERISTIC	TEST CONDITIONS			LIMITS						UNITS
	VOLTAGE V dc		CURRENT A dc	RCA8638C		RCA8638D		RCA8638E		
	V _{CE}	V _{BE}	I _C	Min.	Max.	Min.	Max.	Min.	Max.	
I _{CBO}	140 ^a			-	1	-	-	-	-	mA
	120 ^a			-	-	-	1	-	-	
	100 ^a			-	-	-	-	-	1	
I _{CEX}	140	1.5		-	1	-	-	-	-	
	120	1.5		-	-	-	1	-	-	
I _{CEX} T _C = 150°C	140	1.5		-	5	-	-	-	-	
	120	1.5		-	-	-	5	-	-	
I _{CEO} I _B = 0	70			-	1	-	-	-	-	
	60			-	-	-	1	-	-	
I _{EBO}	5			-	1	-	1	-	1	
h _{FE}	2		5 ^c	25	150	25	150	-	-	
	2		7.5 ^c	-	-	-	-	10	100	
	2		10 ^c	10	-	10	-	-	-	
V _{CER(sus)} ^b R _{BE} ≤ 100Ω			0.2	150	-	130	-	110	-	
V _{CEO(sus)} ^b			0.2	140	-	120	-	100	-	
V _{EBO} I _E = 1 mA			0	5	-	5	-	5	-	
V _{BE}	2		7.5 ^c	-	-	-	-	-	3	
	2		5 ^c	-	2	-	2	-	-	
V _{CE(sat)} I _B = 0.75A = 0.5A			7.5 ^c	-	-	-	-	-	1.5	
			5 ^c	-	1	-	1	-	-	
I _{S/b} t _p = 1 s nonrep.	35			5.71	-	5.71	-	-	-	
	25			-	-	-	-	8	-	
h _{fe} f = 0.5 MHz	10		0.5	4	-	4	-	4	-	
f _T				2	-	2	-	2	-	
C _{ob} f = 0.1 MHz	10 ^a			-	500	-	500	-	500	
R _{θJC}	10		10	-	0.875	-	0.875	-	0.875	

^a V_{CB} ^b CAUTION: Sustaining voltages V_{CEX(sus)}, V_{CER(sus)}, and V_{CEO(sus)} MUST NOT be measured on a curve tracer.

^c Pulsed; pulse duration = 300 μs, duty factor = 1.8%.

MJ15003, RCA3773, RCA8638C, RCA8638D, RCA8638E

ELECTRICAL CHARACTERISTICS, at Case Temperature (T_C) = 25°C Unless Otherwise Specified

CHARACTERISTIC	TEST CONDITIONS			LIMITS				UNITS
	VOLTAGE V dc		CURRENT A dc	RCA3773		MJ15003		
	V _{CE}	V _{BE}		Min.	Max.	Min.	Max.	
I _{CBO}	160 ^a 140 ^a			—	4	—	—	mA
I _{CEX}	140	-1.5		—	1	—	0.1	
I _{CEX} T _C = 150°C	140	-1.5		—	5	—	2	
I _{CEO} I _B = 0	140			—	—	—	0.25	
	120			—	1	—	—	
I _{EBO}	7 5			—	1	—	— 0.1	V
h _{FE}	4 4 2 2		8 ^c 16 ^c 5 ^c 10 ^c	15 5	60	— —	— — 25 150	
V _{CEX(sus)} ^b R _{BE} = 100Ω		-1.5	0.2	160	—	—	—	
V _{CER(sus)} ^b R _{BE} ≤ 100Ω			0.2	150	—	150	—	
V _{CEO(sus)} ^b			0.2	140	—	140	—	
V _{EBO} I _E = 1 mA			0	7	—	5 ^d	—	
V _{BE}	4 2		8 ^c 5 ^c	— —	2.2	— —	— 2	
V _{CE(sat)} I _B = 3.2A = 0.8A = 0.5A			16 ^c 8 ^c 5 ^c	— — —	4 1.4	— —	— — 1	
I _S /b t _p = 1 s nonrep.	100 50			1.5 —	—	1 5	— —	
h _{fe} f = 0.5 MHz	10		0.5	4	—	4	—	
f _T				2	—	2	—	
h _{fe} f = 1 kHz	4		1	40	—	—	—	
C _{ob} f = 0.1 MHz	10 ^a			—	500	—	500	
R _{θJC}	10		10	—	1.17	—	0.7	

^a V_{CB} ^b CAUTION: Sustaining voltages V_{CEX(sus)}, V_{CER(sus)}, and V_{CEO(sus)} MUST NOT be measured on a curve tracer. ^c Pulsed, pulse duration = 300 μs, duty factor = 1.8%. ^d Measured at I_E = -0.1 mA.

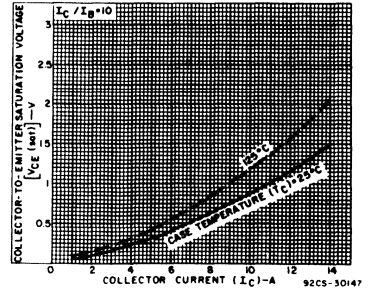


Fig. 4 - Typical saturation voltage characteristics for all types.

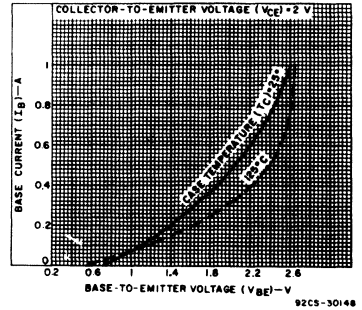


Fig. 5 - Typical input characteristics for all types.

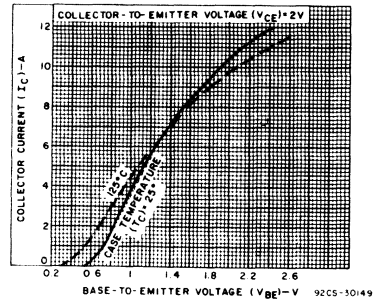


Fig. 6 - Typical transfer characteristics for all types.

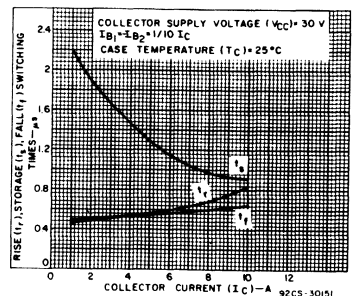
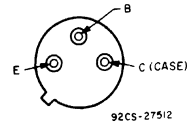


Fig. 7 - Typical saturated-switching times for all types.

RCA1A01–RCA1A11, RCA1A15–RCA1A19

Silicon Transistors for Audio-Frequency Linear-Amplifier Applications

TERMINAL DESIGNATIONS



JEDEC TO-39

"RCA1A-Series" n-p-n and p-n-p silicon transistors are especially characterized for audio-amplifier applications. They are particularly useful as input devices, V_{BE} multipliers for biasing, current sources, load-line-limiting (protection) circuits, predrivers, and in some instances as complementary drivers. Other applications for these devices include audio power amplifiers, linear modulators, servo amplifiers, and operational amplifiers. The units are supplied in the JEDEC TO-39 package.

N-P-N TYPES

- RCA1A01 RCA1A11
- RCA1A03 RCA1A15
- RCA1A06 RCA1A17
- RCA1A07 RCA1A18
- RCA1A09

P-N-P TYPES

- RCA1A02 RCA1A10
- RCA1A04 RCA1A16
- RCA1A05 RCA1A19
- RCA1A08

MAXIMUM RATINGS, Absolute-Maximum Values:

	RCA1A01	RCA1A02	RCA1A03	RCA1A04	RCA1A05	RCA1A06	RCA1A07	RCA1A08
COLLECTOR-TO-BASE VOLTAGE V_{CBO}	—	—	95	—95	—75	75	50	—50
COLLECTOR-TO-EMITTER VOLTAGE:								
With base open V_{CEO}	70	—50	—	—	—	—	40	—40
With external base-to-emitter resistance (R_{BE}) = 100 Ω V_{CER}	—	—	95	—95	—75	75	50*	—50*
EMITTER-TO-BASE VOLTAGE V_{EBO}	4	—4	4	—4	—4	4	3	—5
COLLECTOR CURRENT I_C	1	—1	2	—2	—1	1	1	—1
BASE CURRENT I_B	0.5	—0.5	1	—1	—0.5	0.5	0.05	—0.05
TRANSISTOR DISSIPATION: P_T								
At case temperatures up to 25°C	5	7	10	10	5	5	5	7
At case temperatures above 25°C	← See Fig. 1 →							
TEMPERATURE RANGE:								
Storage & Operating (Junction)	← —65 to +200 → °C							
PIN TEMPERATURE (During Soldering):								
At distances \geq 1/32 in. (0.8 mm) from case for 10 s max.	← 230 → °C							

* R_{BE} = 10 Ω * R_{BE} = 300 Ω

MAXIMUM RATINGS, Absolute-Maximum Values:

	RCA1A09	RCA1A10	RCA1A11	RCA1A15	RCA1A16	RCA1A17	RCA1A18	RCA1A19
COLLECTOR-TO-EMITTER VOLTAGE:								
With base open V_{CEO}	175	—175	175	100	—100	90	10	—10
EMITTER-TO-BASE VOLTAGE V_{EBO}	6	—6	6	5	—5	4	4	—4
COLLECTOR CURRENT I_C	1	—1	1	1	—1	1	1	—1
BASE CURRENT I_B	0.5	—0.5	0.5	0.5	—0.1	0.5	0.5	—0.5
TRANSISTOR DISSIPATION: P_T								
At case temperatures up to 25°C	10	10	10	10	10	5	7	7
At case temperatures above 25°C	← See Fig. 1 →							
TEMPERATURE RANGE:								
Storage & Operating (Junction)	← —65 to +200 → °C							
PIN TEMPERATURE (During Soldering):								
At distances \geq 1/32 in. (0.8 mm) from case for 10 s max.	← 230 → °C							

Type RCA1A01
 Package: JEDEC TO-39
 Construction: Silicon n-p-n, planar

ELECTRICAL CHARACTERISTICS, At Case Temperature (T_C) = 25°C Unless Otherwise Specified

CHARACTERISTIC	TEST CONDITIONS	LIMITS		UNITS
		MIN.	MAX.	
I_{CEO}	$V_{CE} = 60\text{ V}, I_B = 0$	—	1	μA
I_{EBO}	$V_{EB} = 4\text{ V}, I_C = 0$	—	1	mA
V_{CEO}	$I_C = 100\text{ mA}$	70	—	V
f_T	$V_{CE} = 4\text{ V}, I_C = 50\text{ mA}$	120	—	MHz
h_{FE}	$I_C = 10\text{ mA}, V_{CE} = 4\text{ V}$	40	200	
$V_{CE(sat)}$	$I_C = 150\text{ mA}, I_B = 15\text{ mA}$	—	1.4	V
V_{BE}	$I_C = 10\text{ mA}, V_{CE} = 4\text{ V}$	—	1	V

For characteristics curves and test conditions, refer to published data for prototype 2N2102

Type RCA1A02
 Package: JEDEC TO-39
 Construction: Silicon p-n-p, epitaxial planar

ELECTRICAL CHARACTERISTICS, At Case Temperature (T_C) = 25°C Unless Otherwise Specified

CHARACTERISTIC	TEST CONDITIONS	LIMITS		UNITS
		MIN.	MAX.	
I_{CEO}	$V_{CE} = -40\text{ V}, I_B = 0$	—	—1	μA
I_{EBO}	$V_{EB} = -4\text{ V}, I_C = 0$	—	—1	mA
V_{CEO}	$I_C = -0.1\text{ A}$	—50	—	V
f_T	$V_{CE} = -4\text{ V}, I_C = -50\text{ mA}$	60	—	MHz
h_{FE}	$I_C = -0.1\text{ mA}, V_{CE} = -10\text{ V}$	30	200	
V_{BE}	$I_C = -0.1\text{ mA}, V_{CE} = -10\text{ V}$	—	—0.8	V

For characteristics curves and test conditions, refer to published data for prototype 2N4036

RCA1A01–RCA1A11, RCA1A15–RCA1A19

Type RCA1A03

Package: JEDEC TO-39

Construction: Silicon n-p-n, planar

ELECTRICAL CHARACTERISTICS, At Case Temperature (T_C) =
25°C Unless Otherwise Specified

CHARACTERISTIC	TEST CONDITIONS	LIMITS		UNITS
		MIN.	MAX.	
I_{CER}	$V_{CE} = 85 \text{ V}, R_{BE} = 100\Omega$	–	10	μA
I_{EBO}	$V_{EB} = 4 \text{ V}, I_C = 0$	–	0.1	mA
V_{CER}	$I_C = 0.1 \text{ A}, R_{BE} = 100\Omega$	95	–	V
f_T	$I_C = 0.1 \text{ A}, V_{CE} = 4 \text{ V}$	50	–	MHz
h_{FE}	$I_C = 300 \text{ mA}, V_{CE} = 4 \text{ V}$	70	300	
$V_{CE(sat)}$	$I_C = 300 \text{ mA}, I_B = 30 \text{ mA}$	–	0.8	V
V_{BE}	$I_C = 300 \text{ mA}, V_{CE} = 4 \text{ V}$	–	1.4	V
I_S/b	$V_{CE} = 50 \text{ V}, t = 0.4 \text{ s}$	0.2	–	A

For characteristics curves and test conditions, refer to published data for prototype 2N5320

Type RCA1A04

Package: JEDEC TO-39

Construction: Silicon p-n-p, epitaxial-planar

ELECTRICAL CHARACTERISTICS, At Case Temperature (T_C) =
25°C Unless Otherwise Specified

CHARACTERISTIC	TEST CONDITIONS	LIMITS		UNITS
		MIN.	MAX.	
I_{CER}	$V_{CE} = -85 \text{ V}, R_{BE} = 100\Omega$	–	-10	μA
I_{EBO}	$V_{EB} = 4 \text{ V}, I_C = 0$	–	-0.1	mA
V_{CER}	$I_C = -0.1 \text{ A}, R_{BE} = 100\Omega$	-95	–	V
f_T	$I_C = -0.1 \text{ A}, V_{CE} = -4 \text{ V}$	50	–	MHz
h_{FE}	$I_C = -300 \text{ mA}, V_{CE} = -4 \text{ V}$	70	300	
$V_{CE(sat)}$	$I_C = -300 \text{ mA}, I_B = -30 \text{ mA}$	–	-0.8	V
V_{BE}	$I_C = -300 \text{ mA}, V_{CE} = -4 \text{ V}$	–	-1.4	V
I_S/b	$V_{CE} = -35 \text{ V}, t = 0.4 \text{ s}$	-0.285	–	A

For characteristics curves and test conditions, refer to published data for prototype 2N5322

Type RCA1A05

Package: JEDEC TO-39

Construction: Silicon p-n-p epitaxial planar

ELECTRICAL CHARACTERISTICS, At Case Temperature (T_C) =
25°C Unless Otherwise Specified

CHARACTERISTIC	TEST CONDITIONS	LIMITS		UNITS
		MIN.	MAX.	
I_{CER}	$V_{CE} = -65 \text{ V}, R_{BE} = 100\Omega$	–	-10	μA
I_{EBO}	$V_{EB} = -4 \text{ V}, I_C = 0$	–	-0.1	mA
V_{CER}	$I_C = -0.1 \text{ A}, R_{BE} = 100\Omega$	-75	–	V
f_T	$I_C = -50 \text{ mA}, V_{CE} = -4 \text{ V}$	60	–	MHz
h_{FE}	$I_C = -150 \text{ mA}, V_{CE} = -4 \text{ V}$	50	250	
$V_{CE(sat)}$	$I_C = -150 \text{ mA}, I_B = -15 \text{ mA}$	–	-0.8	V
V_{BE}	$I_C = -150 \text{ mA}, V_{CE} = -4 \text{ V}$	–	-1.4	V
I_S/b	$V_{CE} = -65 \text{ V}, t = 0.4 \text{ s}$	-0.1	–	A

For characteristics curves and test conditions, refer to published data for prototype 2N4036

Type RCA1A06

Package: JEDEC TO-39

Construction: Silicon n-p-n, planar

ELECTRICAL CHARACTERISTICS, At Case Temperature (T_C) =
25°C Unless Otherwise Specified

CHARACTERISTIC	TEST CONDITIONS	LIMITS		UNITS
		MIN.	MAX.	
I_{CER}	$V_{CE} = 65 \text{ V}, R_{BE} = 100\Omega$	–	10	μA
I_{EBO}	$V_{EB} = 4 \text{ V}, I_C = 0$	–	0.1	mA
V_{CER}	$I_C = 100 \text{ mA}, R_{BE} = 100\Omega$	75	–	V
f_T	$I_C = 50 \text{ mA}, V_{CE} = 4 \text{ V}$	120	–	MHz
h_{FE}	$I_C = 150 \text{ mA}, V_{CE} = 4 \text{ V}$	50	250	
$V_{CE(sat)}$	$I_C = 150 \text{ mA}, I_B = 15 \text{ mA}$	–	0.8	V
V_{BE}	$I_C = 150 \text{ mA}, V_{CE} = 4 \text{ V}$	–	1.4	V
I_S/b	$V_{CE} = 65 \text{ V}, t = 0.4 \text{ s}$	0.077	–	A

For characteristics curves and test conditions, refer to published data for prototype 2N2102

Type RCA1A07

Package: JEDEC TO-39

Construction: Silicon n-p-n, planar

ELECTRICAL CHARACTERISTICS, At Case Temperature (T_C) =
25°C Unless Otherwise Specified

CHARACTERISTIC	TEST CONDITIONS	LIMITS		UNITS
		MIN.	MAX.	
I_{CEO}	$V_{CE} = 40 \text{ V}$	–	10	μA
I_{EBO}	$V_{EB} = 3 \text{ V}, I_C = 0$	–	0.1	mA
V_{CEO}	$I_C = 100 \text{ mA}$	40	–	V
V_{CER}	$I_C = 100 \text{ mA}, R_{BE} = 10\Omega$	50	–	V
f_T	$V_{CE} = 10 \text{ V}, I_C = 50 \text{ mA}$	120	–	MHz
h_{FE}	$I_C = 3 \text{ mA}, V_{CE} = 10 \text{ V}$	50	250	
$V_{CE(sat)}$	$I_C = 20 \text{ mA}, I_B = 1 \text{ mA}$	–	1	V
$V_{BE(sat)}$	$I_C = 20 \text{ mA}, I_B = 1 \text{ mA}$	–	1.3	V

For characteristics curves and test conditions, refer to published data for prototype 2N2102

Type RCA1A08

Package: JEDEC TO-39

Construction: Silicon p-n-p, epitaxial planar

ELECTRICAL CHARACTERISTICS, At Case Temperature (T_C) =
25°C Unless Otherwise Specified

CHARACTERISTIC	TEST CONDITIONS	LIMITS		UNITS
		MIN.	MAX.	
I_{CER}	$V_{CE} = -40 \text{ V}, R_{BE} = 330\Omega$	–	-10	μA
I_{EBO}	$V_{EB} = -5 \text{ V}$	–	-0.1	mA
V_{CEO}	$I_C = -100 \text{ mA}, I_B = 0$	-40	–	V
V_{CER}	$I_C = -100 \text{ mA}, R_{BE} = 330\Omega$	-50	–	V
f_T	$V_{CE} = -10 \text{ V}, I_C = -50 \text{ mA}$	60	–	MHz
h_{FE}	$I_C = -50 \text{ mA}, V_{CE} = -1.5 \text{ V}$	70	250	
$V_{CE(sat)}$	$I_C = -100 \text{ mA}, I_B = -5 \text{ mA}$	–	-1.4	V
$V_{BE(sat)}$	$I_C = -100 \text{ mA}, I_B = -5 \text{ mA}$	–	-1.4	V
I_S/b	$V_{CE} = -35 \text{ V}, t = 0.05 \text{ s}$	-0.12	–	A

For characteristics curves and test conditions, refer to published data for prototype 2N4036

RCA1A01–RCA1A11, RCA1A15–RCA1A19

Type RCA1A09

Package: JEDEC TO-39

Construction: Silicon n-p-n, epitaxial

ELECTRICAL CHARACTERISTICS, At Case Temperature (T_C) = 25°C Unless Otherwise Specified

CHARACTERISTIC	TEST CONDITIONS	LIMITS		UNITS
		MIN.	MAX.	
I_{CEO}	$V_{CE} = 90\text{ V}, I_B = 0$	–	10	μA
I_{EBO}	$V_{EB} = 6\text{ V}, I_C = 0$	–	100	μA
V_{CEO}	$I_C = 10\text{ mA}, I_B = 0$	175	–	V
f_T	$I_C = 10\text{ mA}, V_{CE} = 10\text{ V}$	15	–	MHz
h_{FE}	$I_C = 10\text{ mA}, V_{CE} = 10\text{ V}$	20	100	
$V_{CE(sat)}$	$I_C = 50\text{ mA}, I_B = 4\text{ mA}$	–	0.5	V
V_{BE}	$I_C = 10\text{ mA}, V_{CE} = 10\text{ V}$	–	0.9	V
$I_{S/b}$	$V_{CE} = 150\text{ V}, t = 1\text{ s}$	0.065	–	A

For characteristics curves and test conditions, refer to published data for prototype 2N3439

Type RCA1A11

Package: JEDEC TO-39

Construction: Silicon n-p-n, epitaxial

ELECTRICAL CHARACTERISTICS, At Case Temperature (T_C) = 25°C Unless Otherwise Specified

CHARACTERISTIC	TEST CONDITIONS	LIMITS		UNITS
		MIN.	MAX.	
I_{CEO}	$V_{CE} = 90\text{ V}, I_B = 0$	–	10	μA
I_{EBO}	$V_{EB} = 6\text{ V}, I_C = 0$	–	100	μA
V_{CEO}	$I_C = 10\text{ mA}, I_B = 0$	175	–	V
f_T	$I_C = 10\text{ mA}, V_{CE} = 10\text{ V}$	15	–	MHz
h_{FE}	$I_C = 1\text{ mA}, V_{CE} = 10\text{ V}$	40	250	
V_{BE}	$I_C = 1\text{ mA}, V_{CE} = 10\text{ V}$	0.5	0.7	V

For characteristics curves and test conditions, refer to published data for prototype 2N3439

Type RCA1A16

Package: JEDEC TO-39

Construction: Silicon p-n-p, epitaxial

ELECTRICAL CHARACTERISTICS, At Case Temperature (T_C) = 25°C Unless Otherwise Specified

CHARACTERISTIC	TEST CONDITIONS	LIMITS		UNITS
		MIN.	MAX.	
I_{CEO}	$V_{CE} = -90\text{ V}$	–	-10	μA
I_{EBO}	$V_{EB} = -5\text{ V}, I_C = 0$	–	-1	mA
V_{CEO}	$I_C = -10\text{ mA}, I_B = 0$	-100	–	V
f_T	$V_{CE} = -10\text{ V}, I_C = -10\text{ mA}$	15	–	MHz
h_{FE}	$I_C = -10\text{ mA}, V_{CE} = -10\text{ V}$	40	250	
$V_{CE(sat)}$	$I_C = -10\text{ mA}, I_B = -1\text{ mA}$	–	-1	V
V_{BE}	$I_C = -10\text{ mA}, V_{CE} = -10\text{ V}$	–	-1	V
$I_{S/b}$	$V_{CE} = -50\text{ V}, t = 0.4\text{ s}$	-0.2	–	A

For characteristics curves and test conditions, refer to published data for prototype 2N5416

Type RCA1A10

Package: JEDEC TO-39

Construction: Silicon p-n-p

ELECTRICAL CHARACTERISTICS, At Case Temperature (T_C) = 25°C Unless Otherwise Specified

CHARACTERISTIC	TEST CONDITIONS	LIMITS		UNITS
		MIN.	MAX.	
I_{CEO}	$V_{CE} = -120\text{ V}, I_B = 0$	–	-10	μA
I_{EBO}	$V_{EB} = -6\text{ V}, I_C = 0$	–	-100	μA
V_{CEO}	$I_C = -10\text{ mA}, I_B = 0$	-175	–	V
f_T	$I_C = -10\text{ mA}, V_{CE} = -10\text{ V}$	15	–	MHz
h_{FE}	$I_C = -10\text{ mA}, V_{CE} = -10\text{ V}$	40	250	
$V_{CE(sat)}$	$I_C = -10\text{ mA}, I_B = -1\text{ mA}$	–	-2	V
V_{BE}	$I_C = -10\text{ mA}, V_{CE} = -10\text{ V}$	–	-0.8	V
$I_{S/b}$	$V_{CE} = -150\text{ V}, t = 1\text{ s}$	-0.04	–	A

For characteristics curves and test conditions, refer to published data for prototype 2N5415

Type RCA1A15

Package: JEDEC TO-39

Construction: Silicon n-p-n, epitaxial

ELECTRICAL CHARACTERISTICS, At Case Temperature (T_C) = 25°C Unless Otherwise Specified

CHARACTERISTIC	TEST CONDITIONS	LIMITS		UNITS
		MIN.	MAX.	
I_{CEO}	$V_{CE} = 90\text{ V}$	–	10	μA
I_{EBO}	$V_{EB} = 5\text{ V}, I_C = 0$	–	1	mA
V_{CEO}	$I_C = 10\text{ mA}, I_B = 0$	100	–	V
f_T	$V_{CE} = 10\text{ V}, I_C = 10\text{ mA}$	15	–	MHz
h_{FE}	$I_C = 10\text{ mA}, V_{CE} = 10\text{ V}$	20	100	
$V_{CE(sat)}$	$I_C = 10\text{ mA}, I_B = 1\text{ mA}$	–	1	V
V_{BE}	$I_C = 10\text{ mA}, V_{CE} = 10\text{ V}$	–	1	V
$I_{S/b}$	$V_{CE} = 50\text{ V}, t = 0.4\text{ s}$	0.2	–	A

For characteristics curves and test conditions, refer to published data for prototype 2N3440

Type RCA1A17

Package: JEDEC TO-39

Construction: Silicon n-p-n, planar

ELECTRICAL CHARACTERISTICS, At Case Temperature (T_C) = 25°C Unless Otherwise Specified

CHARACTERISTIC	TEST CONDITIONS	LIMITS		UNITS
		MIN.	MAX.	
I_{CEO}	$V_{CE} = 80\text{ V}, I_B = 0$	–	1	μA
I_{EBO}	$V_{EB} = 4\text{ V}, I_C = 0$	–	1	mA
V_{CEO}	$I_C = 100\text{ mA}, I_B = 0$	90	–	V
f_T	$V_{CE} = 4\text{ V}, I_C = 50\text{ mA}$	120	–	MHz
h_{FE}	$I_C = 10\text{ mA}, V_{CE} = 4\text{ V}$	40	200	
$V_{CE(sat)}$	$I_C = 150\text{ mA}, I_B = 15\text{ mA}$	–	1.4	V
V_{BE}	$I_C = 10\text{ mA}, V_{CE} = 4\text{ V}$	–	1	V

For characteristics curves and test conditions, refer to published data for prototype 2N2102

RCA1A01–RCA1A11, RCA1A15–RCA1A19

Type RCA1A18

Package: JEDEC TO-39

Construction: Silicon n-p-n, planar

ELECTRICAL CHARACTERISTICS, At Case Temperature (T_C) =
25°C Unless Otherwise Specified

CHARACTERISTIC	TEST CONDITIONS	LIMITS		UNITS
		MIN.	MAX.	
I_{CEO}	$V_{CE} = 5 \text{ V}, I_B = 0$	–	10	μA
I_{EBO}	$V_{EB} = 4 \text{ V}, I_C = 0$	–	1	mA
V_{CEO}	$I_C = 10 \text{ mA}, I_B = 0$	10	–	V
f_T	$I_C = 50 \text{ mA}, V_{CE} = 4 \text{ V}$	120	–	MHz
h_{FE}	$I_C = 10 \text{ mA}, V_{CE} = 4 \text{ V}$	40	250	
$V_{CE(sat)}$	$I_C = 10 \text{ mA}, I_B = 0.5 \text{ mA}$	–	1	V
V_{BE}	$I_C = 10 \text{ mA}, V_{CE} = 4 \text{ V}$	–	0.78	V

For characteristics curves and test conditions, refer to published data for prototype 2N2102

Type RCA1A19

Package: JEDEC TO-39

Construction: Silicon p-n-p, epitaxial planar

ELECTRICAL CHARACTERISTICS, At Case Temperature (T_C) =
25°C Unless Otherwise Specified

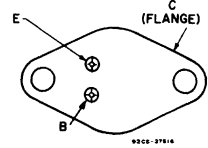
CHARACTERISTIC	TEST CONDITIONS	LIMITS		UNITS
		MIN.	MAX.	
I_{CEO}	$V_{CE} = -5 \text{ V}, I_B = 0$	–	-10	μA
I_{EBO}	$V_{EB} = -4 \text{ V}, I_C = 0$	–	-1	mA
V_{CEO}	$I_C = -10 \text{ mA}, I_B = 0$	-10	–	V
f_T	$I_C = -50 \text{ mA}, V_{CE} = -4 \text{ V}$	60	–	MHz
h_{FE}	$I_C = -10 \text{ mA}, V_{CE} = -4 \text{ V}$	40	250	
$V_{CE(sat)}$	$I_C = -10 \text{ mA}, I_B = -0.5 \text{ mA}$	–	-1	V
V_{BE}	$I_C = -10 \text{ mA}, V_{CE} = -4 \text{ V}$	–	-0.78	V

For characteristics curves and test conditions, refer to published data for prototype 2N4036

RCA1B01

Silicon Transistor for 70-Watt Quasi-Complementary-Symmetry Audio Amplifiers with Hometaxial-Base Output Transistors

TERMINAL DESIGNATIONS



JEDEC TO-3

RCA1B01 is an n-p-n hometaxial-base silicon transistor in a JEDEC TO-3 package. This device is particularly suitable for audio-output use, and can be driven by either the RCA1A03 n-p-n or RCA1A04 p-n-p transistor.

RCA1B01 in conjunction with seven TO-39 transistors, eleven diodes, and an 84-volt split power supply. The amplifier output is directly coupled to an 8-ohm speaker. This amplifier is most useful for instrumentation applications where ruggedness and raw power are essential.

The 70-watt amplifier shown in Fig. 4 uses the

MAXIMUM RATINGS, Absolute-Maximum Values:

CHARACTERISTIC	TEST CONDITIONS	MIN.	MAX.	UNITS
COLLECTOR-TO-BASE VOLTAGE			95	V
COLLECTOR-TO-EMITTER VOLTAGE			95	V
With external base-to-emitter resistance (R_{BE}) = 100Ω			7	V
EMITTER-TO-BASE VOLTAGE			7	V
COLLECTOR CURRENT			15	A
BASE CURRENT			7	A
TRANSISTOR DISSIPATION:				
At case temperatures up to 25°C			115	W
At case temperatures above 25°C			Derate linearly to 200°C	
TEMPERATURE RANGE:				
Storage & Operating (Junction)		-65	200	°C
PIN TEMPERATURE (During Soldering):				
At distances $\geq 1/32$ in. (0.8 mm) from case for 10 s max			230	°C

Type RCA1B01
 Package: JEDEC TO-3
 Construction: Silicon n-p-n, hometaxial base

ELECTRICAL CHARACTERISTICS, At Case Temperature (T_C) = 25°C Unless Otherwise Specified

CHARACTERISTIC	TEST CONDITIONS	LIMITS		UNITS
		MIN.	MAX.	
I_{CER}	$V_{CE} = 85 \text{ V}, R_{BE} = 100\Omega$	—	0.5	mA
I_{EBO}	$V_{EB} = 4 \text{ V}, I_C = 0$	—	1	mA
V_{CER}	$I_C = 0.2 \text{ A}, R_{BE} = 100\Omega$	95	—	V
f_T	$V_{CE} = 4 \text{ V}, I_C = 1 \text{ A}$	0.8	—	MHz
h_{FE}	$I_C = 4 \text{ A}, V_{CE} = 4 \text{ V}$	20	70	
$V_{CE(sat)}$	$I_C = 4 \text{ A}, I_B = 0.4 \text{ A}$	—	1	V
V_{BE}	$I_C = 4 \text{ A}, V_{CE} = 4 \text{ V}$	—	1.4	V
I_S/b	$V_{CE} = 60 \text{ V}, t = 1 \text{ s}$	1.95	—	A

For characteristics curves and test conditions, refer to published data for prototype 2N3055 (Hometaxial).

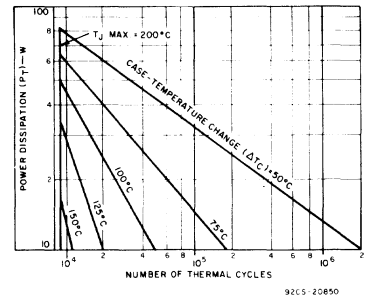
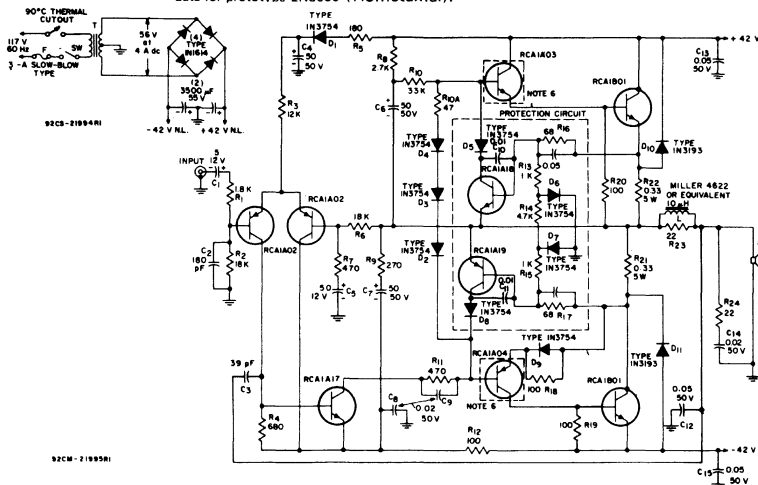


Fig. 2 — Thermal-cycling ratings for RCA1B01.



NOTES:

1. T. Signal 56-4*, Signal Transformer Co., Junius St., Brooklyn, N.Y. 11212
2. Resistors are 1/2-watt unless otherwise specified; values are in ohms.
3. Capacitances are in μF unless otherwise specified.
4. Non-inductive resistors. * Or equivalent.

Fig. 1 — 70-Watt amplifier circuit featuring quasi-complementary-symmetry output employing hometaxial-base output transistors.

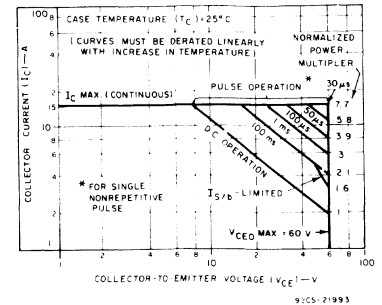


Fig. 3 — Maximum operating areas for RCA1B01.

RCA1B04, RCA1B05, RCA1B09

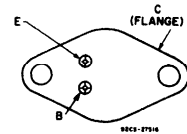
Silicon Transistors for 100-, 120-, 200-, and 300-W Quasi-Complementary-Symmetry Audio Amplifiers with Parallel Output Transistors

The RCA1B04, RCA1B05, and RCA1B09 are silicon n-p-n pi-nu transistors in a JEDEC TO-3 package. They are especially suitable for applications in audio-amplifier circuits, in which they may be used as either driver or output unit.

These devices, together with a variety of other transistors that serve as input devices, VBE amplifiers for biasing, current sources,

load-line limiters (for overload protection), and predrivers, may be used to develop several hundred watts of audio output power in quasi-complementary-symmetry audio-amplifier configurations that employ parallel output transistors. Circuit examples, data are shown for 100-, 120-, 200-, and 300-W amplifiers.

TERMINAL DESIGNATIONS



JEDEC TO-3

MAXIMUM RATINGS, Absolute-Maximum Values:

	RCA1B04	RCA1B05 RCA1B09	
V _{CB0}	225	275	V
V _{CE0}	200	250	V
V _{CE0} R _{BE} = 100 Ω	225	275	V
V _{EBO}		5	V
I _C		7	V
I _B		2	A
P _T			
At T _C ≤ 25°C		150	W
At T _C > 25°C		Derate linearly to 200°C	
T _{stg} , T _J		-65 to 200	°C
T _L			
At distance ≥ 1/32 in. (0.8 mm) from seating plane for 10 s max.		230	°C

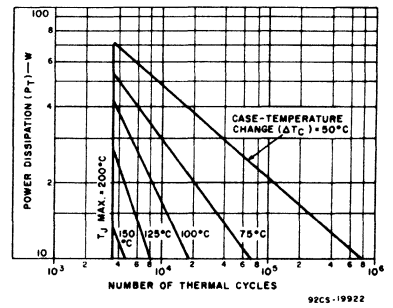


Fig. 1 - Thermal-cycling ratings for RCA1B04 and RCA1B05.

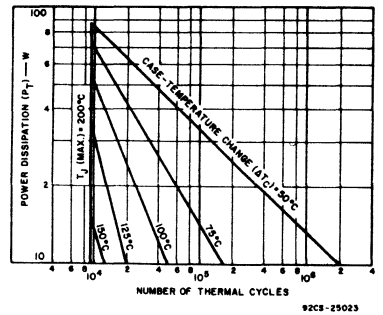


Fig. 2 - Thermal-cycling rating chart for RCA1B09.

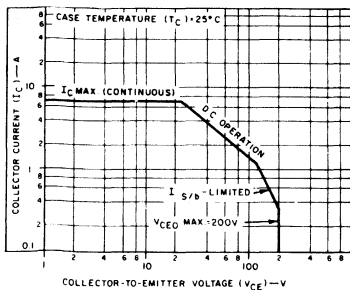


Fig. 3 - Maximum operating areas for RCA1B04.

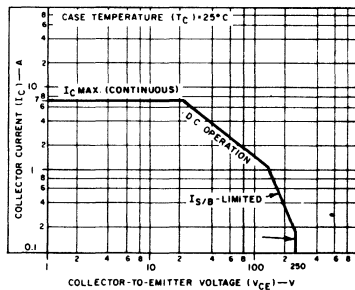


Fig. 4 - Maximum operating areas for RCA1B05.

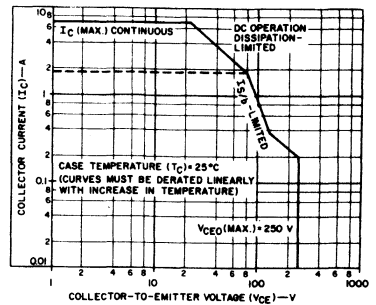


Fig. 5 - Maximum operating areas for RCA1B09.

RCA1B04, RCA1B05, RCA1B09

ELECTRICAL CHARACTERISTICS, At Case Temperature (T_C) = 25°C

CHARACTERISTIC	TEST CONDITIONS	LIMITS						UNITS
		RCA1B04▲		RCA1B05*		RCA1B09**		
		Min.	Max.	Min.	Max.	Min.	Max.	
I_{CER}	$V_{CE} = 120 \text{ V}, R_{BE} = 100 \Omega$ $V_{CE} = 200 \text{ V}, R_{BE} = 100 \Omega$	-	1	-	-	-	-	mA
I_{EBO}	$V_{EB} = 5 \text{ V}, I_C = 0$	-	1	-	1	-	1	mA
V_{CEO}	$I_C = 0.2 \text{ A}, I_B = 0$	200	-	250	-	250	-	V
V_{CER}	$I_C = 0.2 \text{ A}, R_{BE} = 100 \Omega$	225	-	275	-	275	-	V
f_T	$I_C = 0.2 \text{ A}, V_{CE} = 10 \text{ V}$ $I_C = 1 \text{ A}, V_{CE} = 15 \text{ V}$	5	-	5	-	-	5	MHz
h_{FE}	$I_C = 2 \text{ A}, V_{CE} = 5 \text{ V}$	15	75	15	75	40	-	
$V_{CE(sat)}$	$I_C = 2 \text{ A}, I_B = 0.255 \text{ A}$ $I_C = 2 \text{ A}, I_B = 0.2 \text{ A}$	-	2	-	2	-	-	V
V_{BE}	$I_C = 2 \text{ A}, V_{CE} = 5 \text{ V}$	0.75	1.75	0.75	1.75	-	1	V
$I_{S/b}$	$V_{CE} = 120 \text{ V}, t = 1 \text{ s}$ $V_{CE} = 140 \text{ V}, t = 1 \text{ s}$ $V_{CE} = 80 \text{ V}, t = 1 \text{ s}$	1.25	-	-	-	-	-	A

- ▲ For characteristics curves and test conditions, refer to published data for prototype 2N5239
- * For characteristics curves and test conditions, refer to published data for prototype 2N5240
- ** For characteristics curves and test conditions, refer to published data for prototype 2N6510

100-W Amplifier

The 100-W amplifier shown in Figs. 6 and 7 uses two RCA1B09 transistors as drivers and four RCA1B05 transistors as parallel units in the amplifier output stages, and operates on a 104-V split power supply.

This 100-W amplifier [DC-Coupled (Fig.6) or ACCoupled (Fig.7)] is conservatively designed

to provide excellent high-power performance into an 8-Ω load. With the exception of the RCA-CA3100 Linear Integrated Circuit for front end, this amplifier is entirely push-pull for improved high-frequency distortion and slew rate. Additional circuit features include new thermal overload protection and instant turn-on with no undesirable transients.

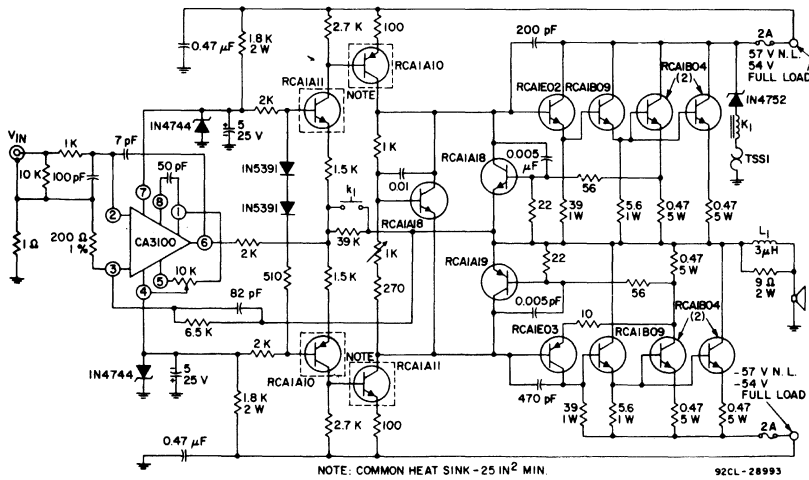
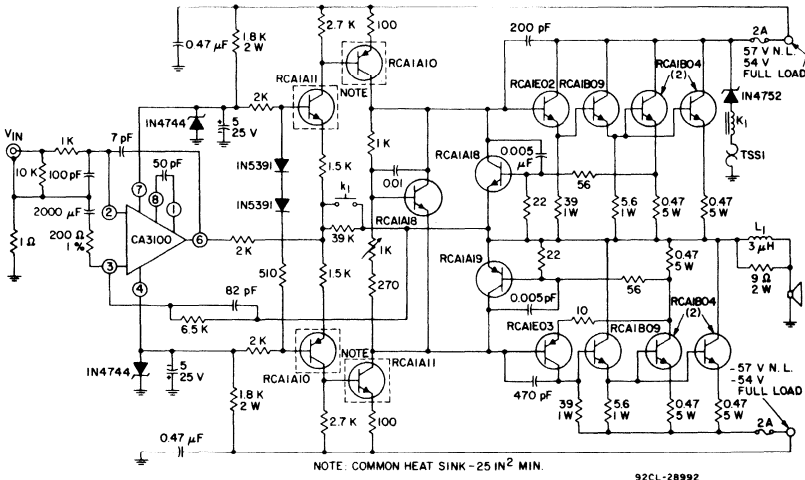


Fig. 6 - 100-W dc-coupled audio amplifier circuit featuring parallel output transistors.

RCA1B04, RCA1B05, RCA1B09



OUTPUT HEAT SINK - 1°C/W PER OUTPUT TRANSISTOR

SET IDLING CURRENT FOR 150 - 200 mA THROUGH 2 A FUSE.

- NOTES:**
- 1. All resistors 1/2 W, 5% carbon unless specified.
 - 2. All capacitances in μF unless specified.
 - 3. All resistors are non-inductive.
 - 4. K-1 Relay, single-pole, single-throw, normally closed, with 24 V, 3 mA coil.
 - 5. TSS1 - 70°C thermal cutout, Elmwood Sensor Part No. 3450-157-37, or equivalent.

Fig. 7 - 100-W ac-coupled audio amplifier circuit featuring parallel output transistors.

NOTE:
Power Transformer: Signal BO-8 (Signal Transformer Co., 1 Junius St., Brooklyn, N.Y. 11212), or equivalent.

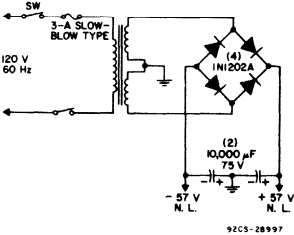


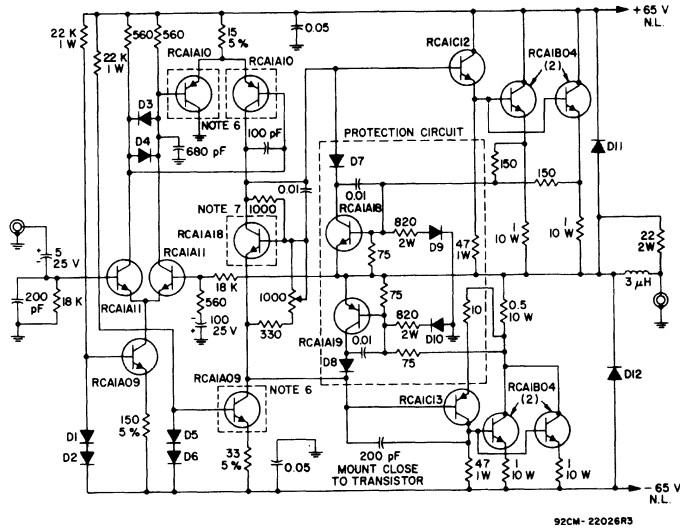
Fig. 8 - Power supply for 100-W audio amplifiers shown in Figs. 6 and 7.

120-W Amplifier

The 120-W amplifier shown in Fig. 9 uses four RCA1B04 transistors as parallel units in the amplifier output stages, and operates on a 130-V split power supply.

This 120-W amplifier is especially designed for top-of-the line quadrasonic use in applications requiring 1/2 kW of quadrasonic sound with excellent tonal quality. The amplifier output is directly coupled to an 8-Ω speaker.

RCA1B04, RCA1B05, RCA1B09

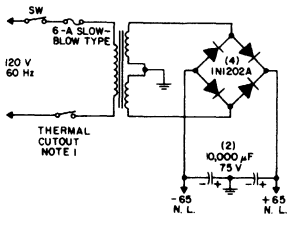


NOTES:

1. D1-D8 - 1N5391; D9,D10 - 1N914B; D11, D12 - 1N5393
2. Resistors are 1/2 W \pm 10% unless otherwise specified; values are in ohms
3. Capacitances are in μ F unless otherwise specified.
4. Non-inductive resistors
5. Provide approx. 1°C/W heat sinking per output device based on mounting with mica washer

6. Mount on heat sink, Wakefield No. 209-AB, or equivalent. (Alternatively, this type may be obtained with a factory-attached integral heat sink).
7. Attach heat sink cap (Wakefield No.260-6SH5E, or equivalent) on device and mount on same heat sink with output transistor.

Fig. 9 - 120-W audio-amplifier circuit featuring parallel output transistors.



NOTES:

1. 93°C thermal cutout (attached to heat sink for output transistors (Elmwood Sensor part No. 2455-88-4), or equivalent).
2. Power transformer: Signal 88-6, Signal Transformer Co., 1 Junius St., Brooklyn, N.Y. 11212, or equivalent. Use 125-V primary tap.

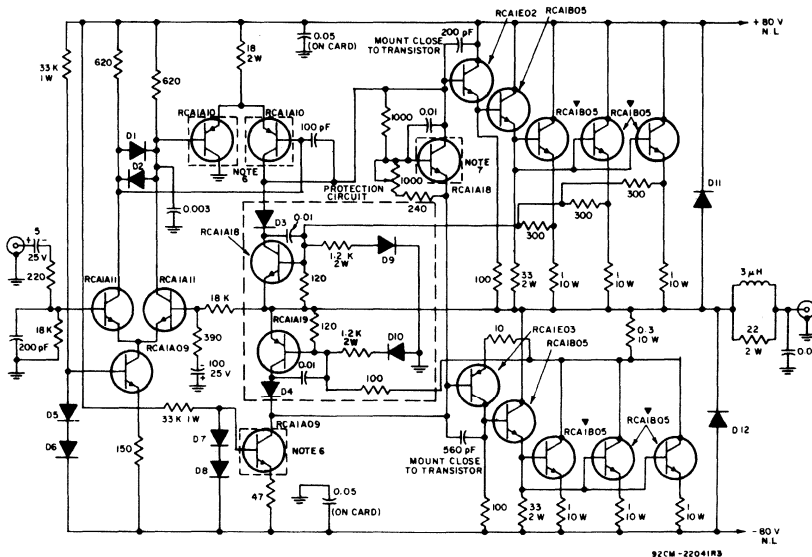
Fig. 10 - Power supply for 120-W audio amplifier circuit shown in Fig. 9.

200-W Amplifier

The 200-W amplifier shown in Fig. 11 uses eight RCA 1B05 transistors, two as drivers and six as parallel units in the amplifier output stages, and operates on a 160-V split power supply.

This 200-W amplifier is especially designed to feature ruggedness in combination with high power output and excellent high fidelity performance. The amplifier output is directly coupled to an 8- Ω speaker.

RCA1B04, RCA1B05, RCA1B09



NOTES:

1. D1-D8 - 1N5391; D9, D10 - 1N5316; D11, D12 - 1N5393.
2. Resistors are 1/2W ± 10% unless otherwise specified, values are in ohms.
3. Capacitances are in μF unless otherwise specified.
4. Non-inductive resistors.
5. ▼ Provide approx. 1°C/W heat sinking per out-

- put device based on mounting with mica washer and ZnO thermal compound (Dow Corning No. 340, or equivalent) with T_A = 45°C max.
6. Mount on heat sink, Wakefield No. 209-AB, or equivalent. (Alternately, this type may be obtained with a factory-attached integral heat sink.)
7. Attach heat sink cap (Wakefield No. 260-6SHSE, or equivalent) on device and mount on same heat sink with output transistor.

Fig. 11 - 200-W audio amplifier circuit featuring parallel output transistors.

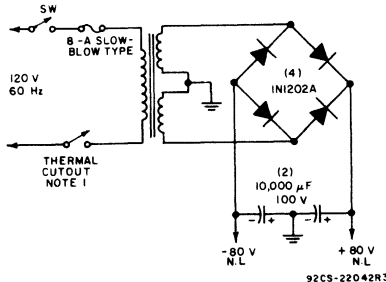


Fig. 12 - Power supply for 200-W audio amplifier circuit shown in Fig. 11.

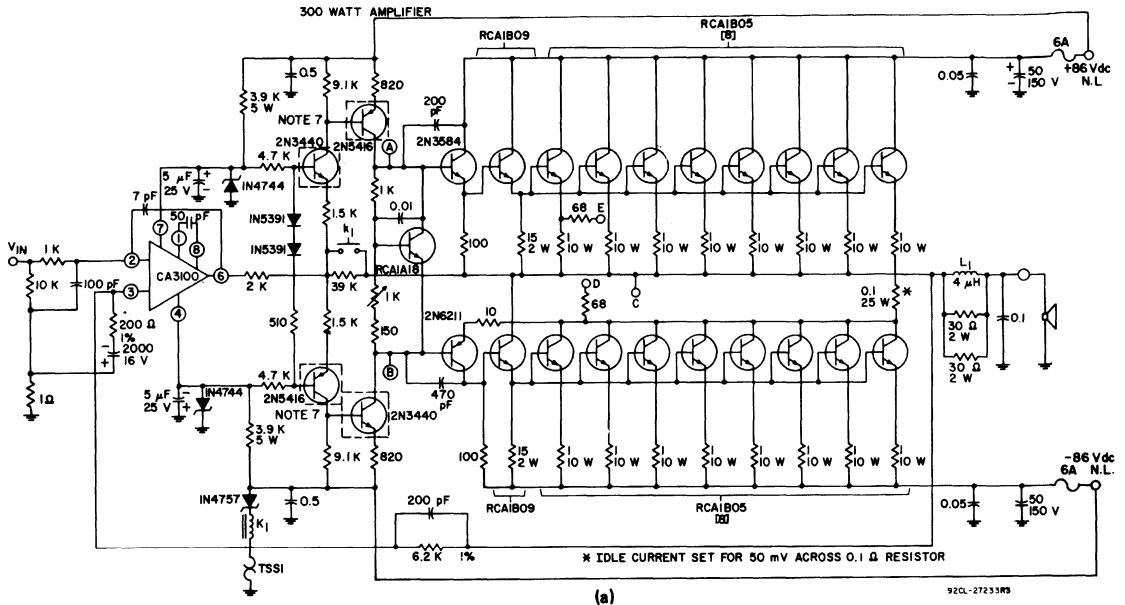
300-W Amplifier

The 300-W amplifier shown in Fig. 13 uses two RCA1B09 transistors as drivers and sixteen RCA1B05 transistors as parallel units in the amplifier output stages, and operates on a 172-V split power supply.

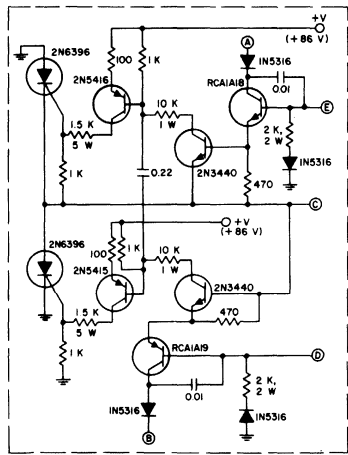
This 300-W amplifier is conservatively designed to provide excellent high-power per-

formance into either 8-Ω or 4-Ω loads. With the exception of the RCA-CA3100 linear integrated circuit for the front end, this amplifier is entirely push-pull for improved high-frequency distortion and slew rate. Additional circuit features include new thermal overload and reactive overload protection and instant turn-on with no undesirable transients.

RCA1B04, RCA1B05, RCA1B09



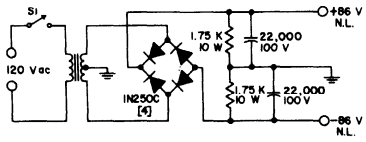
(a)



(b)

- NOTES:**
1. All resistors 1/2 W, 5% carbon unless specified.
 2. All capacitances in microfarads unless specified.
 3. All resistors are non-inductive.
 4. K1-Relay, single-pole, single-throw, normally closed, with 24-V, 3 mA coil.
 5. TSS1-70°C thermal cutout, Elmwood Sensor Part No. 3450-157-37, or equivalent.
 6. For dc-coupled version, delete 2,000-μF capacitor, add 10-kΩ potentiometer – see 100-W amplifier circuit Fig.9 (a).
 7. Common heat sink – 25 in.² minimum.

Fig. 13 – 300-W audio amplifier circuit featuring parallel output transistors: (a) basic amplifier circuit, (b) protection circuit.



POWER TRANSFORMER SIGNAL 120-20
 (SIGNAL TRANSFORMER CO., JANIUS ST.,
 BROOKLYN, N.Y. 11212), OR EQUIVALENT
 SI-20-A CIRCUIT BREAKER

Fig. 14 – Power supply for 300-W audio-amplifier circuit shown in Fig. 13.

RCA1B06

Silicon Transistor for 70-Watt Quasi-Complementary-Symmetry Audio Amplifiers with Pi-Nu Output Transistors

RCA1B06 is an n-p-n pi-nu silicon transistor in a JEDEC TO-3 package. This device is especially characterized for audio-amplifier applications, and can be driven by either RCA1C03 or RCA1C04, n-p-n and p-n-p types, respectively. The 70-watt amplifier shown in Fig. 1 uses the

RCA1B06 output device in conjunction with eleven other discrete transistors, thirteen diodes, and a 90-volt split power supply. The amplifier output is directly coupled in an 8-ohm speaker. The high-frequency RCA1B06 output transistors used in the amplifier circuit produce excellent transient response at a high power level.

MAXIMUM RATINGS, Absolute-Maximum Values:

	RCA1B06	
COLLECTOR-TO-BASE VOLTAGE	120	V
COLLECTOR-TO-EMITTER VOLTAGE:		
With base open	V _{CEO}	100 V
With external base-to-emitter resistance (R _{BE}) = 100Ω	V _{CER}	120 V
EMITTER-TO-BASE VOLTAGE	V _{EB0}	6 V
COLLECTOR CURRENT	I _C	7 A
BASE CURRENT	I _B	2 A
TRANSISTOR DISSIPATION:	P _T	
At case temperatures up to 25°C		150 W
At case temperatures above 25°C		
TEMPERATURE RANGE:		Derate linearly to 200°C
Storage & Operating (Junction)		-65 to 200 °C
PIN TEMPERATURE (During Soldering):		230 °C
At distances ≥ 1/32 in. (0.8 mm) from case for 10 s max		

Type RCA1B06

Package: JEDEC TO-3

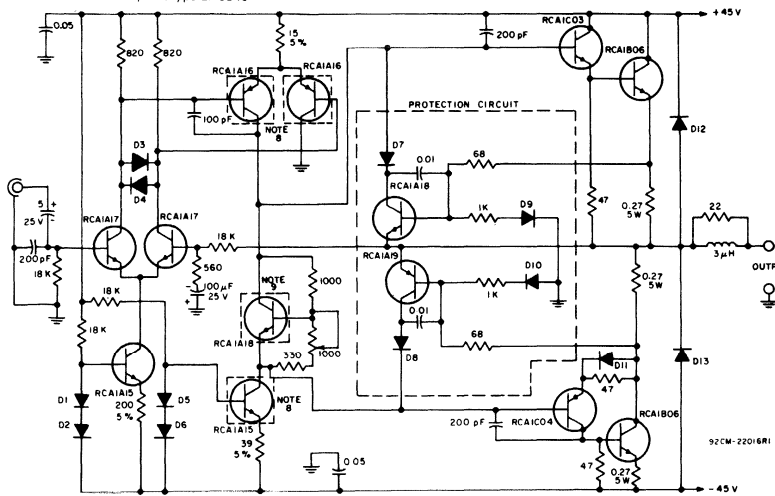
Construction: Silicon n-p-n, epitaxial, multiple-emitter-site, pi-nu

ELECTRICAL CHARACTERISTICS, At Case Temperature (T_C) = 25°C

Unless Otherwise Specified

CHARACTERISTIC	TEST CONDITIONS	LIMITS		UNITS
		MIN.	MAX.	
I _{CER}	V _{CE} = 90 V, R _{BE} = 100Ω	—	1	mA
V _{CEO}	I _C = 0.2 A, I _B = 0	100	—	V
f _T	I _C = 0.2 A, V _{CE} = 10 V	5	—	MHz
h _{FE}	I _C = 4 A, V _{CE} = 4 V	10	50	
V _{CE(sat)}	I _C = 4 A, I _B = 0.8 A	—	2	V
V _{BE}	I _C = 4 A, V _{CE} = 4 V	—	2	V
I _{S/b}	V _{CE} = 80 V, t = 1 s	1.87	—	A

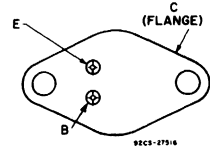
For characteristics curves and test conditions, refer to published data for prototype 2N5840



- NOTES:
- 100°C thermal cutout attached to heat sink for output transistors (Eimwood Sensor part No. 2455-88-4).
 - Power transformer: Signal 120-2 (parallel secondary). Signal Transformer Co., 1 Junius St., Brooklyn, N. Y. 11212.
 - Resistors are 1/2-watt unless otherwise specified; values are in ohms.
 - Capacitances are in μF unless otherwise specified.
 - Non-inductive resistors.
 - D1-D8, D11-1N5391; D9, D10, D12, D13-1N5393. * Or equivalent.

Fig. 1 - 70-Watt amplifier circuit featuring quasi-complementary-symmetry output employing pi-nu construction output transistors.

TERMINAL DESIGNATIONS



JEDEC TO-3

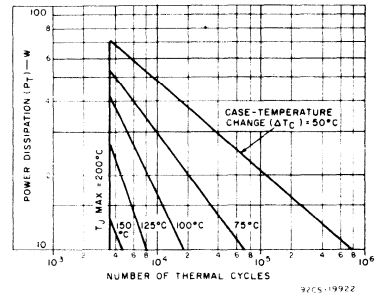


Fig. 2 - Thermal-cycling ratings for RCA1B06.

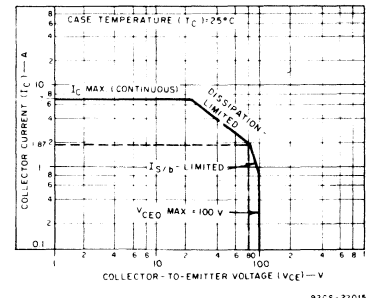


Fig. 3 - Maximum operating areas for RCA1B06.

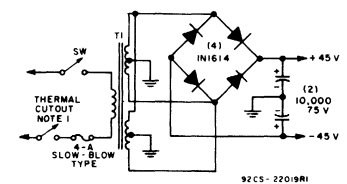


Fig. 4 - Power supply for 70-watt audio-amplifier shown in Fig. 3.

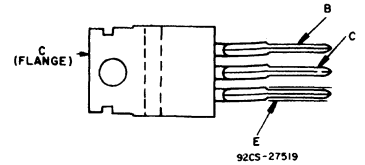
RCA1C03, RCA1C04, RCA1C12, RCA1C13

Silicon Transistors for Audio-Frequency Linear-Amplifier Applications

RCA1C03, RCA1C04, RCA1C12, and RCA1C13 are complementary silicon n-p-n and p-n-p transistors especially characterized for audio-amplifier applications. These devices, singly or in pairs in complementary- or quasi-complementary-symmetry circuits, are particularly useful as drivers or pre-

drivers. They may also be used in audio power amplifiers, linear modulators, servo amplifiers, and operational amplifiers. The units are supplied in the JEDEC TO-220AB version of the plastic VERSAWATT package.

TERMINAL DESIGNATIONS



BOTTOM VIEW JEDEC TO-220AB

N-P-N Types	P-N-P Types
RCA1C03	RCA1C04
RCA1C12	RCA1C13

MAXIMUM RATINGS, Absolute-Maximum Values:

	RCA1C03	RCA1C04	RCA1C12	RCA1C13	
COLLECTOR-TO-BASE VOLTAGE	120	-120	140	-140	V
COLLECTOR-TO-EMITTER SUSTAINING VOLTAGE:					
With base open	100	-100	120	-120	V
With external base-to-emitter resistance (R_{BE}) = 100 Ω	120	-120	140	-140	V
EMITTER-TO-BASE VOLTAGE	5	-5	5	-5	V
CONTINUOUS COLLECTOR CURRENT	4	-4	4	-4	A
CONTINUOUS BASE CURRENT	2	-2	2	-2	A
TRANSISTOR DISSIPATION:					W
At case temperatures up to 25°C	40	40	40	40	
At case temperatures above 25°C	← Derate linearly to 150°C →				
TEMPERATURE RANGE:					°C
Storage and Operating (Junction)	← -65 to +150 →				
PIN TEMPERATURE (During Soldering):					°C
At distances \geq 1/32 in. (0.8 mm) from seating plane for 10 s max.	← 230 →				

Type RCA1C03

Package: JEDEC TO-220AB

Construction: Silicon n-p-n, epitaxial

ELECTRICAL CHARACTERISTICS, At Case Temperature (T_C) = 25°C Unless Otherwise Specified

CHARACTERISTIC	TEST CONDITIONS	LIMITS		UNITS
		MIN.	MAX.	
I_{CER}	$V_{CE} = 110 V, R_{BE} = 100\Omega$	-	1	mA
I_{EBO}	$V_{EB} = 5 V, I_C = 0$	-	1	mA
V_{CEO}	$I_C = 0.1 A, I_B = 0$	100	-	V
f_T	$I_C = 0.5 A, V_{CE} = 4 V$	4	-	MHz
h_{FE}	$I_C = 1 A, V_{CE} = 4 V$	50	250	
$V_{CE(sat)}$	$I_C = 1 A, I_B = 0.1 A$	-	1	V
V_{BE}	$I_C = 1 A, V_{CE} = 4 V$	-	1.5	V
$I_{S/b}$	$V_{CE} = 40 V, t = 0.4 s$	1	-	A

For characteristics curves and test conditions, refer to published data for prototype 2N6293.

Type RCA1C12

Package: JEDEC TO-220AB

Construction: Silicon n-p-n, epitaxial

ELECTRICAL CHARACTERISTICS, At Case Temperature (T_C) = 25°C Unless Otherwise Specified

CHARACTERISTIC	TEST CONDITIONS	LIMITS		UNITS
		MIN.	MAX.	
I_{CER}	$V_{CE} = 90 V, R_{BE} = 100\Omega$	-	100	μA
I_{EBO}	$V_{EB} = 5 V, I_C = 0$	-	1	mA
V_{CEO}	$I_C = 0.1 A, I_B = 0$	120	-	V
V_{CER}	$I_C = 0.1 A, R_{BE} = 100\Omega$	140	-	V
f_T	$I_C = 0.5 A, V_{CE} = 4 V$	4	-	MHz
h_{FE}	$I_C = 1 A, V_{CE} = 2 V$	40	250	
V_{BE}	$I_C = 1 A, V_{CE} = 2 V$	-	1.2	V
$I_{S/b}$	$V_{CE} = 60 V, t = 0.4 s$	0.66	-	A

For characteristics curves and test conditions, refer to published data for prototype 2N6474.

Type RCA1C04

Package: JEDEC TO-220AB

Construction: Silicon p-n-p, epitaxial

ELECTRICAL CHARACTERISTICS, At Case Temperature (T_C) = 25°C Unless Otherwise Specified

CHARACTERISTIC	TEST CONDITIONS	LIMITS		UNITS
		MIN.	MAX.	
I_{CER}	$V_{CE} = -110 V, R_{BE} = 100\Omega$	-	-1	mA
I_{EBO}	$V_{EB} = -5 V, I_C = 0$	-	-1	mA
V_{CEO}	$I_C = -0.1 A, I_B = 0$	-100	-	V
f_T	$I_C = -0.5 A, V_{CE} = -4 V$	10	-	MHz
h_{FE}	$I_C = -1 A, V_{CE} = -4 V$	50	250	
$V_{CE(sat)}$	$I_C = -1 A, I_B = -0.1 A$	-	-1	V
V_{BE}	$I_C = -1 A, V_{CE} = -4 V$	-	-1.5	V
$I_{S/b}$	$V_{CE} = -40 V, t = 0.4 s$	-1	-	A

For characteristics curves and test conditions, refer to published data for prototype 2N6476.

Type RCA1C13

Package: JEDEC TO-220AB

Construction: Silicon p-n-p, epitaxial

ELECTRICAL CHARACTERISTICS, At Case Temperature (T_C) = 25°C Unless Otherwise Specified

CHARACTERISTIC	TEST CONDITIONS	LIMITS		UNITS
		MIN.	MAX.	
I_{CER}	$V_{CE} = -90 V, R_{BE} = 100\Omega$	-	-100	μA
I_{EBO}	$V_{EB} = -5 V, I_C = 0$	-	-1	mA
V_{CEO}	$I_C = -0.1 A, I_B = 0$	-120	-	V
V_{CER}	$I_C = -0.1 A, R_{BE} = 100\Omega$	-140	-	V
f_T	$I_C = -0.5 A, V_{CE} = -4 V$	10	-	MHz
h_{FE}	$I_C = -1 A, V_{CE} = -2 V$	40	250	
V_{BE}	$I_C = -1 A, V_{CE} = -2 V$	-	-1.2	V
$I_{S/b}$	$V_{CE} = -60 V, t = 0.4 s$	-0.66	-	A

For characteristics curves and test conditions, refer to published data for prototype 2N6476.

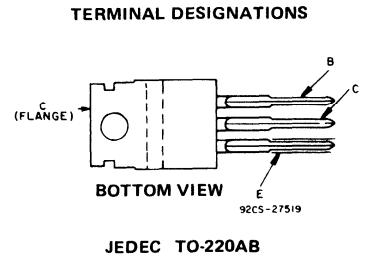
RCA1C05, RCA1C06

Silicon Transistors for 25-Watt Full-Complementary-Symmetry Audio Amplifiers

RCA1C05 and RCA1C06 are n-p-n and p-n-p epitaxial-base silicon power transistors, respectively. These complementary output devices for audio applications are provided in the JEDEC TO-220AB plastic package.

The 25-watt audio-amplifier circuit shown in Fig. 4 uses RCA1C05 and RCA1C06 as output devices in conjunc-

tion with seven TO-39 discrete transistors, ten diodes, and a 52-volt split power supply. The amplifier output is directly coupled to an 8-ohm speaker. The full-complementary-symmetry output stage provides excellent high-frequency performance at moderate cost.



MAXIMUM RATINGS, Absolute-Maximum Values:

	RCA1C05	RCA1C06	
COLLECTOR-TO-BASE VOLTAGE	VCBO	60	-60 V
COLLECTOR-TO-EMITTER VOLTAGE:			
With base open	VCEO	50	-50 V
With external base-to-emitter resistance (RBE) = 100Ω	VCER	60	-60 V
EMITTER-TO-BASE VOLTAGE	VEBO	5	-5 V
COLLECTOR CURRENT	IC	7	-7 A
BASE CURRENT	IB	3	-3 A
TRANSISTOR DISSIPATION:			
At case temperatures up to 25°C	PT	40	40 W
At case temperatures above 25°C			Derate linearly to 150°C
TEMPERATURE RANGE:			
Storage & Operating (Junction)			-65 to +150 °C
PIN TEMPERATURE (During Soldering):			
At distances ≥1/32 in. (0.8 mm) from case of 10 s max.		230	°C

Type RCA1C05
 Package: JEDEC TO-220AB
 Construction: Silicon n-p-n, epitaxial base

ELECTRICAL CHARACTERISTICS, At Case Temperature (TC) = 25°C Unless Otherwise Specified

CHARACTERISTIC	TEST CONDITIONS	LIMITS		UNITS
		MIN.	MAX.	
ICER	VCE = 50 V, RBE = 100Ω	-	1	mA
IEBO	VBE = 5 V, IC = 0	-	1	mA
VCER	IC = 0.1 A, RBE = 100Ω	60	-	V
fT	IC = 0.1 A, VCE = 4 V	4	-	MHz
hFE	IC = 3 A, VCE = 4 V	20	120	
VCE(sat)	IC = 3 A, IB = 0.3 A	-	1	V
VBE	IC = 3 A, VCE = 4 V	-	1.5	V
IS/b	VCE = 20 V, t = 0.5 s	2	-	A

For characteristics curves and test conditions, refer to published data for prototype 2N6292

Type RCA1C06
 Package: JEDEC TO-220AB
 Construction: Silicon p-n-p, epitaxial base

ELECTRICAL CHARACTERISTICS, At Case Temperature (TC) = 25°C Unless Otherwise Specified

CHARACTERISTIC	TEST CONDITIONS	LIMITS		UNITS
		MIN.	MAX.	
ICER	VCE = -50 V, RBE = 100Ω	-	-1	mA
IEBO	VEB = -5 V, IC = 0	-	-1	mA
VCER	IC = -0.1 A, RBE = 100Ω	-60	-	V
fT	IC = -0.1 A, VCE = -4 V	10	-	MHz
hFE	IC = -3 A, VCE = -4 V	20	120	
VCE(sat)	IC = -3 A, IB = -0.3 A	-	-1	V
VBE	IC = -3 A, VCE = -4 V	-	-1.5	V
IS/b	VCE = -20 V, t = 0.5 s	-2	-	A

For characteristics curves and test conditions, refer to published data for prototype 2N6107 (File 488).

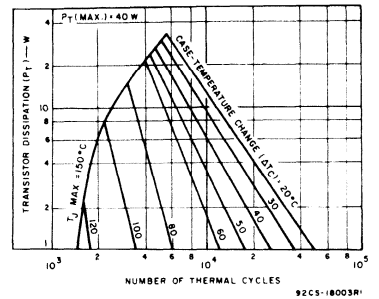


Fig. 1 — Thermal-cycling ratings for RCA1C05 and RCA1C06.

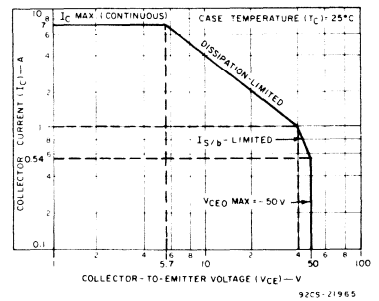


Fig. 2 — Maximum operating areas for RCA1C05.

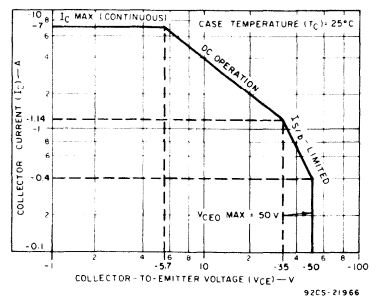
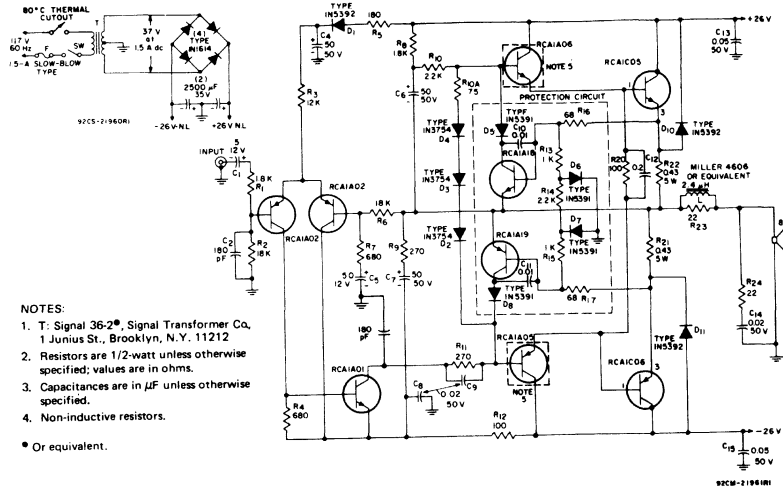


Fig. 3 — Maximum operating areas for RCA1C06.

RCA1C05, RCA1C06



- NOTES:
1. T: Signal 36-2[®], Signal Transformer Co., 1 Junius St., Brooklyn, N.Y. 11212
 2. Resistors are 1/2-watt unless otherwise specified; values are in ohms.
 3. Capacitances are in μF unless otherwise specified.
 4. Non-inductive resistors.
- Or equivalent.

Fig. 4 — 25-watt amplifier circuit featuring true-complementary-symmetry output with load line limiting.

Silicon Transistors for 40-Watt Full-Complementary-Symmetry Audio Amplifiers

RCA1C07 and RCA1C08 are n-p-n and p-n-p epitaxial-base silicon power transistors, respectively, especially suitable for audio-output applications. These devices are provided in the economical JEDEC TO-220AB version of the VERSAWATT package.

The 40-watt amplifier shown in Fig. 3 uses the

RCA1C07 and RCA1C08 in conjunction with seven TO-39 transistors, ten diodes, and a 64-volt split power supply. The amplifier output is directly coupled to an 8-ohm speaker. The high-frequency performance of this 40-watt amplifier will provide excellent reproduction for the most critical listener.

MAXIMUM RATINGS, Absolute-Maximum Values:

COLLECTOR-TO-BASE-VOLTAGE	V_{CBO}
COLLECTOR-TO-EMITTER VOLTAGE:	
With base open	V_{CEO}
With external base-to-emitter resistance (R_{BE}) = 100 Ω	V_{CER}
EMITTER-TO-BASE VOLTAGE	V_{EBO}
COLLECTOR CURRENT	I_C
BASE CURRENT	I_B
TRANSISTOR DISSIPATION:	P_T
At case temperatures up to 25°C	
At case temperatures above 25°C	
TEMPERATURE RANGE:	
Storage & Operating (Junction)	
PIN TEMPERATURE (During Soldering):	
At distances $\geq 1/32$ in. (0.8 mm) from case for 10 s max.	

	RCA1C07	RCA1C08	
V_{CBO}	75	-75	V
V_{CEO}	65	-65	V
V_{CER}	75	-75	V
V_{EBO}	5	-5	V
I_C	10	-10	A
I_B	4	-4	A
P_T	75	75	W
	Derate linearly to 150°C		
	← -65 to 150 →		°C
	← 230 →		°C

Type RCA1C07
 Package: JEDEC TO-220AB
 Construction: Silicon n-p-n, epitaxial base

ELECTRICAL CHARACTERISTICS, At Case Temperature (T_C) = 25°C Unless Otherwise Specified

CHARACTERISTIC	TEST CONDITIONS	LIMITS		UNITS
		MIN.	MAX.	
I_{CER}	$V_{CE} = 65V, R_{BE} = 100\Omega$	-	1	mA
I_{EBO}	$V_{BE} = 5V, I_C = 0$	-	1	mA
V_{CER}	$I_C = 0.1A, R_{BE} = 100\Omega$	75	-	V
f_T	$I_C = 1A, V_{CE} = 4V$	5	-	MHz
h_{FE}	$I_C = 4A, V_{CE} = 4V$	20	120	
$V_{CE(sat)}$	$I_C = 4A, I_B = 0.4A$	-	1	V
V_{BE}	$I_C = 4A, V_{CE} = 4V$	-	1.5	V
$I_{S/b}$	$V_{CE} = 30V, t = 0.5s$	2.5	-	A

For characteristics curves and test conditions, refer to published data for prototype 2N6292

Type RCA1C08
 Package: JEDEC TO-220AB
 Construction: Silicon p-n-p, epitaxial base

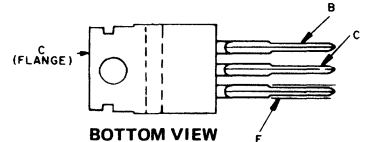
ELECTRICAL CHARACTERISTICS, At Case Temperature (T_C) = 25°C Unless Otherwise Specified

CHARACTERISTIC	TEST CONDITIONS	LIMITS		UNITS
		MIN.	MAX.	
I_{CER}	$V_{CE} = -65V, R_{BE} = 100\Omega$	-	-1	mA
I_{EBO}	$V_{EB} = -5V, I_C = 0$	-	-1	mA
V_{CER}	$I_C = -0.1A, R_{BE} = 100\Omega$	-75	-	V
f_T	$I_C = -1A, V_{CE} = -4V$	5	-	MHz
h_{FE}	$I_C = -4A, V_{CE} = -4V$	20	120	
$V_{CE(sat)}$	$I_C = -4A, I_B = -0.4A$	-	-1	V
V_{BE}	$I_C = -4A, V_{CE} = -4V$	-	-1.5	V
$I_{S/b}$	$V_{CE} = -30V, t = 0.5s$	-2.5	-	A

For characteristics curves and test conditions, refer to published data for prototype 2N6107 (File 488).

RCA1C07, RCA1C08

TERMINAL DESIGNATIONS



JEDEC TO-220AB

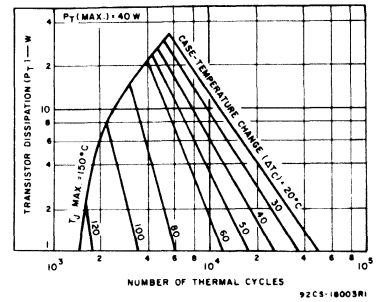
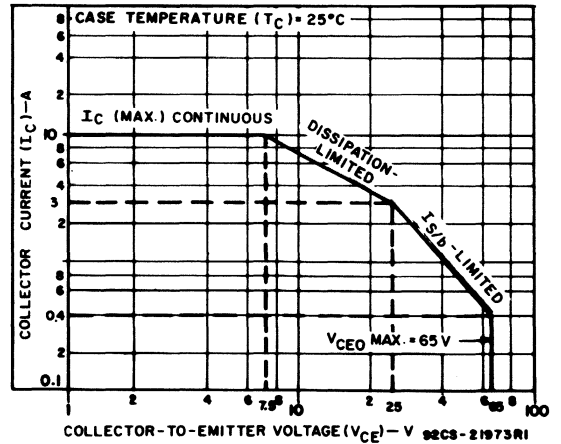


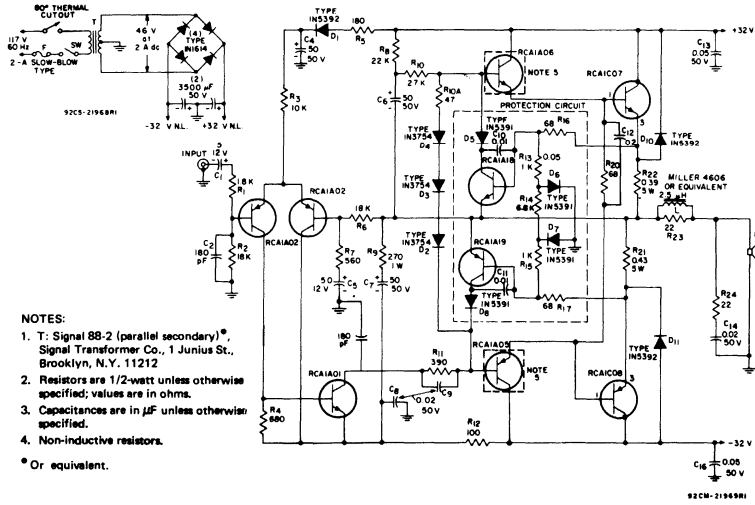
Fig. 1 - Thermal-cycling ratings for RCA1C07 and RCA1C08.



◆ For p-n-p device, voltage and current are negative.

Fig. 2 - Maximum operating areas for RCA1C07 and RCA1C08.

RCA1C07, RCA1C08



- NOTES:
1. T: Signal 88-2 (parallel secondary)*, Signal Transformer Co., 1 Junius St., Brooklyn, N.Y. 11212
 2. Resistors are 1/2-watt unless otherwise specified; values are in ohms.
 3. Capacitances are in μF unless otherwise specified.
 4. Non-inductive resistors.
- * Or equivalent.

Fig. 3 - 40-Watt amplifier circuit featuring full-complementary-symmetry output using load line limiting.

RCA1C09

Silicon Transistor for 40-Watt Quasi-Complementary-Symmetry Audio Amplifiers

RCA1C09 is an n-p-n, homotaxial-base silicon transistor packaged in the JEDEC TO-220AB (VERSAWATT) case. Two of these devices, driven in the class-B mode by the RCA1A06 and RCA1A05 silicon n-p-n and p-n-p transistors, can be used as output devices in audio-amplifier applications.

The 40-watt amplifier shown in Fig. 3 uses two RCA1C09 transistors as output units in conjunction with seven TO-39 transistors, 11 diodes, and a 64-volt split power supply. The amplifier output is directly coupled to an 8-ohm speaker. This 40-watt amplifier features ruggedness and economy in the mid-power range.

MAXIMUM RATINGS, Absolute-Maximum Values:

		RCA1C09		
COLLECTOR-TO-BASE VOLTAGE	V_{CBO}	75		V
COLLECTOR-TO-EMITTER VOLTAGE:				
With base open	V_{CEO}	65		V
With external base-to-emitter resistance (R_{BE}) = 100Ω	V_{CER}	75		V
EMITTER-TO-BASE VOLTAGE	V_{EBO}	5		V
COLLECTOR CURRENT	I_C	10		A
BASE CURRENT	I_B	4		A
TRANSISTOR DISSIPATION:	P_T			
At case temperatures up to 25°C		75		W
At case temperatures above 25°C		Derate linearly to 150°C		
TEMPERATURE RANGE:				
Storage & Operating (Junction)		-65 to 150		°C
PIN TEMPERATURE (During Soldering):				
At distances $\geq 1/32$ in. (0.8 mm) from case for 10 s max.		230		°C

Type RCA1C09

Package: JEDEC TO-220AB

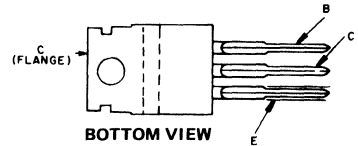
Construction: Silicon n-p-n, homotaxial base

ELECTRICAL CHARACTERISTICS, At Case Temperature (T_C) = 25°C Unless Otherwise Specified

CHARACTERISTIC	TEST CONDITIONS	LIMITS		UNITS
		MIN.	MAX.	
I_{CER}	$V_{CE} = 65V, R_{BE} = 100\Omega$	-	1	mA
I_{EBO}	$V_{EB} = 5V, I_C = 0$	-	1	mA
V_{CER}	$I_C = 0.2A, R_{BE} = 100\Omega$	75	-	V
f_T	$I_C = 0.5A, V_{CE} = 4V$	0.8	-	MHz
h_{FE}	$I_C = 4A, V_{CE} = 4V$	20	120	
$V_{CE(sat)}$	$I_C = 4A, I_B = 0.4A$	-	1	V
V_{BE}	$I_C = 4A, V_{CE} = 4V$	-	1.5	V
I_S/b	$V_{CE} = 40V, t = 0.5s$	1.87	-	A

For characteristics curves and test conditions, refer to published

TERMINAL DESIGNATIONS



JEDEC TO-220AB

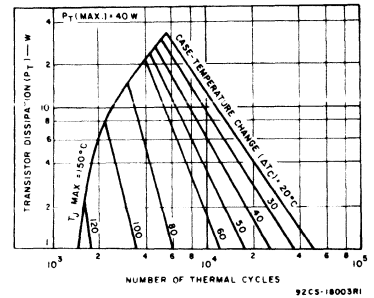
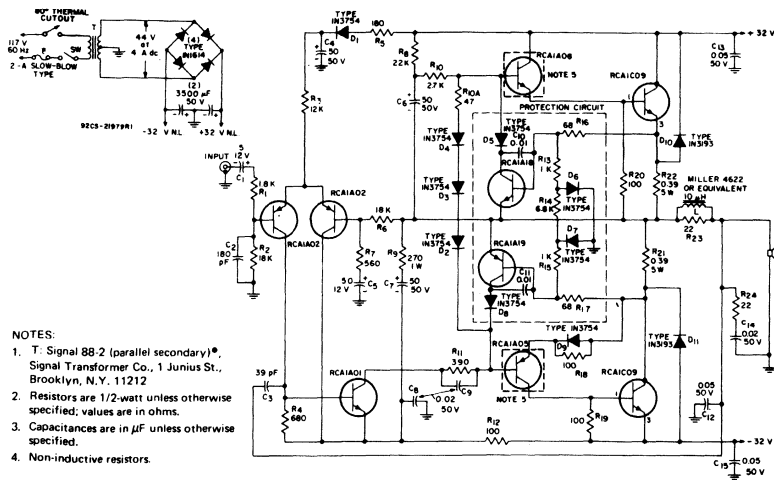


Fig. 2 - Thermal-cycling ratings for RCA1C09.



- NOTES:
1. T. Signal 88-2 (parallel secondary)*, Signal Transformer Co., 1 Junius St., Brooklyn, N.Y. 11212
 2. Resistors are 1/2-watt unless otherwise specified; values are in ohms.
 3. Capacitances are in μF unless otherwise specified.
 4. Non-inductive resistors.
- * Or equivalent.

Fig. 1 - 40-Watt amplifier circuit featuring quasi-complementary-symmetry output.

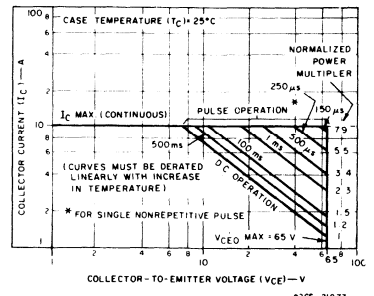


Fig. 3 - Maximum operating areas for RCA1C09.

RCA1C10, RCA1C11

Silicon Transistors for 12-Watt True-Complementary-Symmetry Audio Amplifiers

RCA1C10 and RCA1C11 are n-p-n and p-n-p epitaxial-base silicon power transistors, respectively, especially characterized for audio-output service. To enhance circuit economics, they are provided in the JEDEC TO-220AB version of the VERSAWATT plastic package.

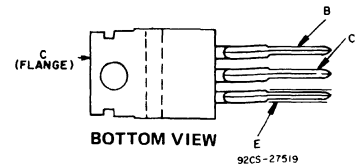
The 12-watt audio amplifier circuit shown in Fig. 4 uses RCA1C10 and RCA1C11 as output devices in conjunction with three discrete transistors, two diodes, and a single 36-volt power supply; the amplifier output is capacitively coupled to an 8-ohm speaker. The choice of a true-complementary-symmetry output stage provides excellent fidelity for a low-cost system.

The 12-watt amplifier circuit shown in Fig. 5 uses

RCA1C10 and RCA1C11 discrete transistors, an integrated circuit, one diode, and a 36-volt split power supply; the amplifier output is directly coupled to an 8-ohm speaker. The integrated circuit-true-complementary-symmetry combination provides a high-quality, low-cost amplifier.

The RCA CA3094AT integrated circuit provides sufficient drive current for the complementary-symmetry output stage. Tone controls, bass and treble, with functions of "boost" and "cut" are incorporated into the feedback loop of the amplifier, resulting in excellent signal-to-noise ratio and freedom from distortion. Ratings and characteristics of type CA3094AT are given in RCA data bulletin File 598.

TERMINAL DESIGNATIONS



MAXIMUM RATINGS, Absolute-Maximum Values:

	RCA1C10	RCA1C11	
COLLECTOR-TO-BASE VOLTAGE	40	-40	V
COLLECTOR-TO-EMITTER VOLTAGE:			
With base open	40	-40	V
With external base-to-emitter resistance (R_{BE}) = 100Ω	50	-50	V
EMITTER-TO-BASE VOLTAGE	5	-5	V
COLLECTOR CURRENT	7	-7	A
BASE CURRENT	3	-3	A
TRANSISTOR DISSIPATION:			
At case temperatures up to 25°C	40	40	W
At case temperatures above 25°C	Derate linearly to 150°C		
TEMPERATURE RANGE:			
Storage & Operating (Junction)	-65 to 150		°C
PIN TEMPERATURE (During Soldering):			
At distances $\geq 1/32$ in. (0.8 mm) from case for 10 s max.	230		°C

Type RCA1C10

Package: JEDEC TO-220AB
Construction: Silicon n-p-n, epitaxial-base

ELECTRICAL CHARACTERISTICS, At Case Temperature (T_C) = 25°C Unless Otherwise Specified

CHARACTERISTIC	TEST CONDITIONS	LIMITS		UNITS
		MIN.	MAX.	
I_{CER}	$V_{CE} = 35 V, R_{BE} = 100\Omega$	-	10	μA
I_{EBO}	$V_{EB} = 5 V$	-	1	mA
V_{CEO}	$I_C = 0.1 A, I_B = 0$	40	-	V
V_{CER}	$I_C = 0.1 A, R_{BE} = 100\Omega$	50	-	V
f_T	$V_{CE} = 4 V, I_C = 0.5 A$	4	-	MHz
h_{FE}	$I_C = 1.5 A, V_{CE} = 4 V$	50	250	
$V_{CE(sat)}$	$I_C = 1.5 A, I_B = 0.075 A$	-	1	V
V_{BE}	$I_C = 1.5 A, V_{CE} = 4 V$	-	1.5	V
$I_{S/b}$	$V_{CE} = 20 V, t = 0.4 s$	2	-	A

For characteristics curves and test conditions, refer to published data for prototype 2N6292

Type RCA1C11

Package: JEDEC TO-220AB
Construction: Silicon p-n-p, epitaxial base

ELECTRICAL CHARACTERISTICS, At Case Temperature (T_C) = 25°C Unless Otherwise Specified

CHARACTERISTIC	TEST CONDITIONS	LIMITS		UNITS
		MIN.	MAX.	
I_{CER}	$V_{CE} = -35 V, R_{BE} = 100\Omega$	-	-10	μA
I_{EBO}	$V_{EB} = -5 V$	-	-1	mA
V_{CEO}	$I_C = -0.1 A, I_B = 0$	-40	-	V
V_{CER}	$I_C = -0.1 A, R_{BE} = 100\Omega$	-50	-	V
f_T	$V_{CE} = -4 V, I_C = -0.5 A$	10	-	MHz
h_{FE}	$I_C = -1.5 A, V_{CE} = -4 V$	50	250	
$V_{CE(sat)}$	$I_C = -1.5 A, I_B = -0.075 A$	-	-1	V
V_{BE}	$I_C = -1.5 A, V_{CE} = -4 V$	-	-1.5	V
$I_{S/b}$	$V_{CE} = -20 V, t = 0.4 s$	-2	-	A

For characteristics curves and test conditions, refer to published data for prototype 2N6107

RCA1C10, RCA1C11

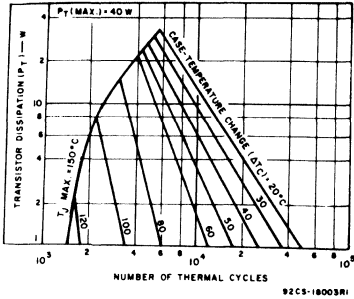


Fig. 1 - Thermal-cycling ratings for RCA1C10 and RCA1C11.

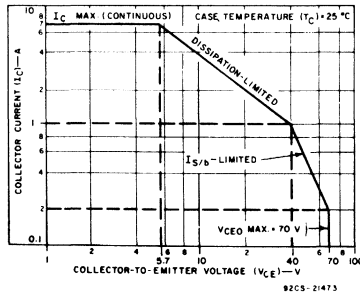


Fig. 2 - Maximum operating areas for RCA1C10.

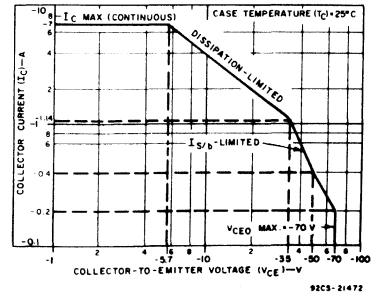
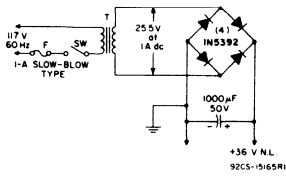


Fig. 3 - Maximum operating areas for RCA1C11.



NOTES:

1. T: Thorderson 23V118, Stancor TP4, Triad F-93X, or equivalent (for Stereo Amplifiers).
2. Resistors are 1/2-watt unless otherwise specified; values are in ohms.
3. Capacitances are in μF unless otherwise specified.
4. Non-inductive resistors.

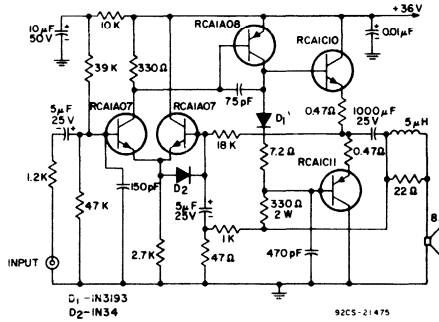
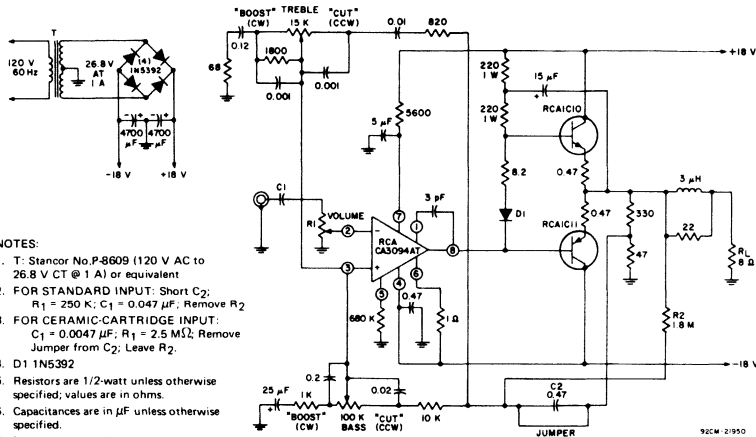


Fig. 4 - 12-watt amplifier circuit featuring complementary-symmetry output.



NOTES:

1. T: Stancor No. P-8609 (120 V AC to 26.8 V CT @ 1 A) or equivalent
2. FOR STANDARD INPUT: Short C₂; R₁ = 250 K; C₁ = 0.047 μF. Remove R₂
3. FOR CERAMIC-CARTRIDGE INPUT: C₁ = 0.0047 μF; R₁ = 2.5 MΩ. Remove Jumper from C₂; Leave R₂.
4. D1 1N5392
5. Resistors are 1/2-watt unless otherwise specified; values are in ohms.
6. Capacitances are in μF unless otherwise specified.
7. Non-inductive resistors.

Fig. 5 - 12-watt amplifier circuit featuring an integrated-circuit driver and a true-complementary-symmetry output stage.

RCA1C14

Silicon Transistor for 25-Watt Quasi-Complementary-Symmetry Audio Amplifiers

RCA1C14 is an n-p-n homotaxial-base silicon power transistor provided in the JEDEC TO-220AB package. This device is ideally suited for use in the output stage of quasi-complementary-symmetry audio amplifiers

The 25-watt audio-amplifier circuit shown in Fig. 2

uses two RCA1C14 transistors in conjunction with seven TO-39 low-level audio transistors, 11 diodes, and a 52-volt split supply. The amplifier output is directly coupled to an 8-ohm speaker. Ruggedness and economy are features of this high fidelity amplifier.

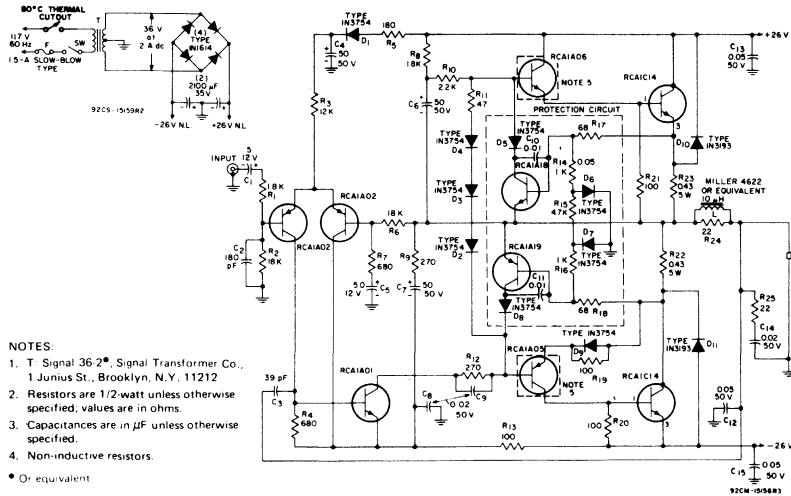
MAXIMUM RATINGS, Absolute-Maximum Values:

		RCA1C14		
COLLECTOR-TO-BASE VOLTAGE	V _{CB0}	60		V
COLLECTOR-TO-EMITTER VOLTAGE:				
With base open	V _{CEO}	40		V
With external base-to-emitter resistance (R _{BE}) = 100Ω	V _{CER}	60		V
EMITTER-TO-BASE VOLTAGE	V _{EBO}	5		V
COLLECTOR CURRENT	I _C	7		A
BASE CURRENT	I _B	3		A
TRANSISTOR DISSIPATION:	P _T			
At case temperatures up to 25°C		50		W
At case temperatures above 25°C		Derate linearly to 150°C		
TEMPERATURE RANGE:				
Storage & Operating (Junction)		-65 to 150		°C
PIN TEMPERATURE (During Soldering):				
At distances ≥1/32 in. (0.8 mm) from case for 10 s max.		230		°C

ELECTRICAL CHARACTERISTICS, At Case Temperature (T_C) = 25°C Unless Otherwise Specified

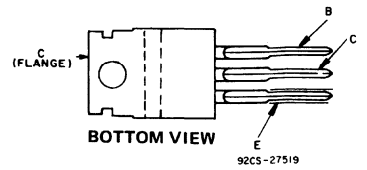
CHARACTERISTIC	TEST CONDITIONS	LIMITS		UNITS
		MIN.	MAX.	
I _{CER}	V _{CE} = 50 V, R _{BE} = 100Ω	-	0.5	mA
I _{EBO}	V _{EB} = 5 V, I _C = 0	-	1	mA
V _{CEO}	I _C = 1 A, I _B = 0	40	-	V
V _{CER}	I _C = 0.1 A, R _{BE} = 100Ω	60	-	V
f _T	I _C = 0.5 A, V _{CE} = 4 V	0.8	-	MHz
h _{FE}	I _C = 3 A, V _{CE} = 4 V	20	70	
V _{CE(sat)}	I _C = 3 A, I _B = 0.3 A	-	1	V
V _{BE}	I _C = 3 A, V _{CE} = 4 V	-	1.4	V
I _{S/b}	V _{CE} = 40 V, t = 0.5 s	1.25	-	A

For characteristics curves and test conditions, refer to published data for prototype 2N5495



- NOTES
1. T-Signal 362*, Signal Transformer Co., 1 Junius St., Brooklyn, N.Y. 11212
 2. Resistors are 1/2-watt unless otherwise specified, values are in ohms.
 3. Capacitances are in μF unless otherwise specified.
 4. Non-inductive resistors.
- * Or equivalent

TERMINAL DESIGNATIONS



JEDEC TO-220AB

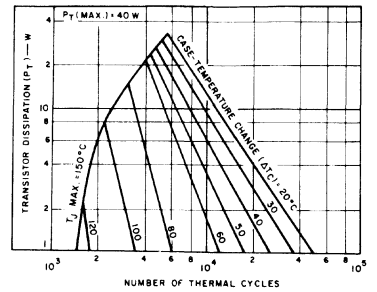


Fig. 1 - Thermal-cycling ratings for RCA1C14.

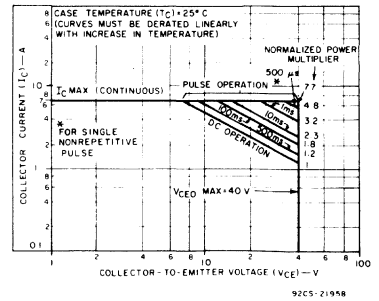


Fig. 3 - Maximum operating areas for RCA1C14.

Fig. 2 - 25-watt amplifier circuit featuring quasi-complementary-symmetry output.

RCA1C15, RCA1C16

Silicon Transistors for 20-Watt Full-Complementary-Symmetry Audio Amplifiers with Darlington Output Transistors

The RCA1C15 and RCA1C16 are complementary silicon n-p-n and p-n-p Darlington transistors. They are especially suitable for use as output devices in audio applications. These transistors are provided in the economical JEDEC TO-220AB straight-lead version of the VERSAWATT package. Optional lead configurations are available upon request.

The 20-watt audio amplifier shown in Fig. 5 uses the RCA1C15 and RCA1C16 as output devices in conjunction with seven discrete transistors, eight diodes, and an integrated circuit. With the exception of the RCA CA3140B linear integrated circuit for the front end, this amplifier is entirely push-pull for improved high-frequency distortion and slew rate.

MAXIMUM RATINGS, Absolute-Maximum Values:

	RCA1C15	RCA1C16
V_{CE0}	80	-80 V
V_{CE0} (sus)	80	-80 V
V_{CE0} (sus)	80	-80 V
$R_{BE} = 100 \Omega$	80	-80 V
V_{CEV} (sus)	80	-80 V
$V_{BE} = 1.5$ V reverse bias ..	80	-80 V
V_{EBO}	5	-5 V
I_C	10	-10 A
I_{CM}	15	-15 A
I_B	0.25	-0.25 A
P_T	65	65 W
At $T_C \leq 25^\circ C$	0.52	W/ $^\circ C$
At $T_C > 25^\circ C$ derate linearly ..	-65 to +150	$^\circ C$
T_{stg} T_J	—	235 $^\circ C$
T_L	—	235 $^\circ C$
At distance $\geq 1/32$ in. (0.8 mm) from seating plane for 10 s max.	—	235 $^\circ C$

Type: RCA1C15, RCA1C16

Package: JEDEC TO-220

ELECTRICAL CHARACTERISTICS, At Case Temperature (T_C) = 25°C, unless otherwise specified

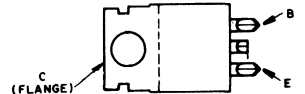
CHARACTERISTIC	TEST CONDITIONS*	LIMITS				UNITS
		RCA1C15*		RCA1C16**		
		Min.	Max.	Min.	Max.	
I_{CE0}	$V_{CE} = 80$ V, $I_B = 0$	—	1	—	-1	mA
I_{CEV}	$V_{CE} = 80$ V, $V_{BE} = -1.5$ V	—	0.3	—	-0.3	mA
	$T_C = 125^\circ C$, $V_{CE} = 80$ V, $V_{BE} = -1.5$ V	—	3	—	-3	mA
I_{EBO}	$V_{BE} = 5$ V, $I_C = 0$	—	5	—	-10	mA
V_{CE0} (sus)	$I_C = 0.2$ A, $I_B = 0$	80	—	-80	—	V
V_{CE0} (sus)	$I_C = 0.2$ A, $R_{BE} = 100 \Omega$	80	—	-80	—	V
V_{CEV} (sus)	$I_C = 0.2$ A, $V_{BE} = -1.5$ V	80	—	-80	—	V
h_{FE}	$I_C = 3$ A, $V_{CE} = 5$ V	1000	20,000	1000	20,000	
V_{CE} (sat)	$I_C = 5$ A, $I_B = 0.01$ A	—	2	—	-2	V
V_{BE}	$I_C = 3$ A, $V_{CE} = 5$ V	—	2.8	—	-2.8	V
V_F	$I_C = -10$ A	—	4	—	4	V
$ h_{fe} $	$I_C = 1$ A, $V_{CE} = 5$ V, $f = 1$ MHz	20	—	20	—	
$I_{S/b}$	$V_{CE} = 25$ V, $t = 1$ s	2.6	—	-2.6	—	A

* For RCA1C16, reverse polarity of voltage and current.

* For characteristics curves and test conditions, refer to published data for prototype 2N6388

** For characteristics curves and test conditions, refer to published data for prototype 2N6668.

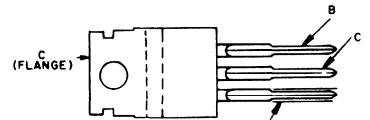
TERMINAL DESIGNATIONS



92CS-27520

BOTTOM VIEW

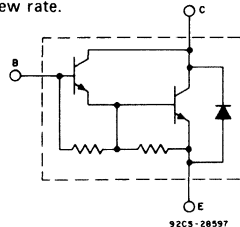
JEDEC TO-220AA



92CS-27519

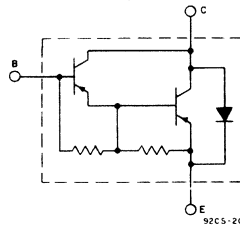
BOTTOM VIEW

JEDEC TO-220AB



92CS-28597

Fig. 1 - Schematic diagram for RCA1C15.



92CS-20863R1

Fig. 2 - Schematic diagram for RCA1C16.

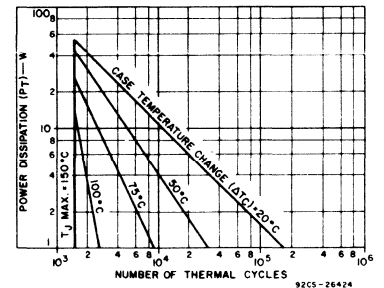
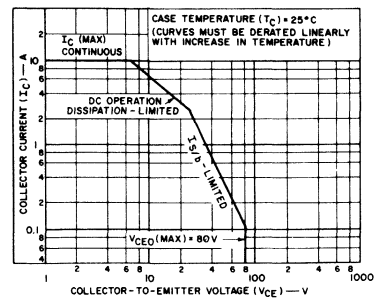


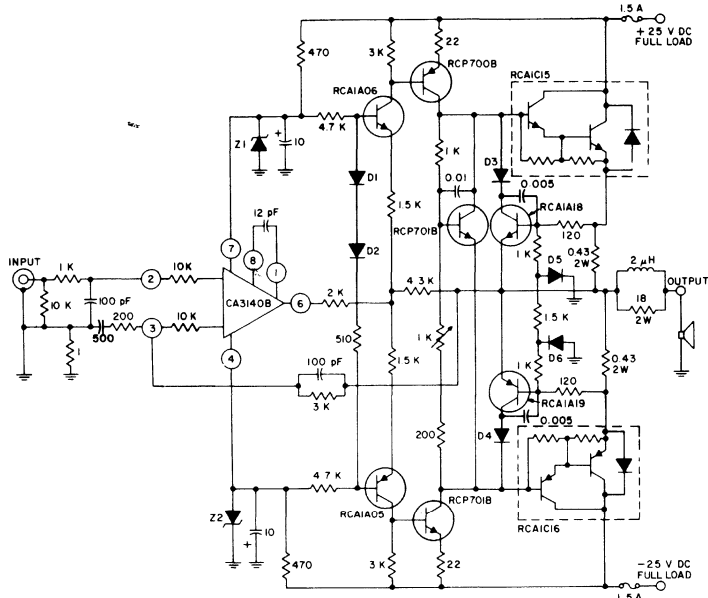
Fig. 3 - Thermal-cycling rating chart for both types.



92CS-29287

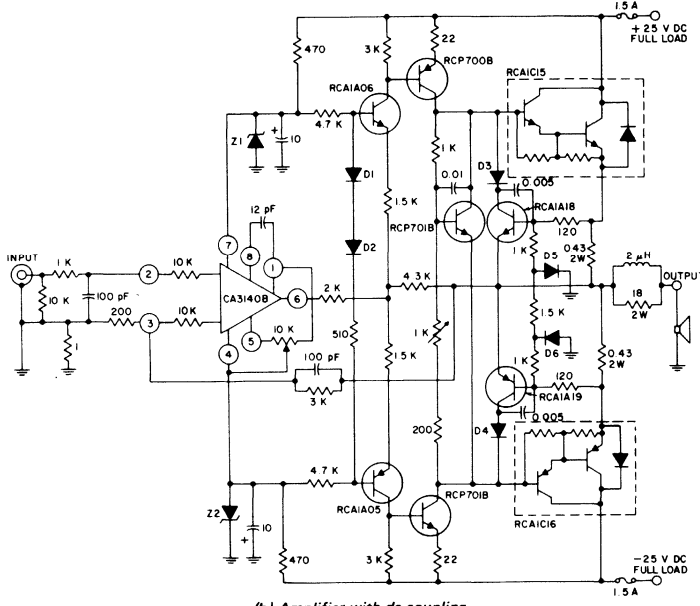
Fig. 4 - Maximum operating areas for both types.

RCA1C15, RCA1C16



(a) Amplifier with ac coupling

92CL-29288



(b) Amplifier with dc coupling

92CL-29289

NOTES:

1. D1–D2 = D1300A; D4–D6 = 1N914
2. Z1–Z2 = 1N4744
3. Resistors are 1/2-watt, ±10% unless otherwise specified; values are in ohms

4. Capacitors are in μF unless otherwise specified
5. Non-inductive resistors
6. Heat sink for output transistors should be 1.3°C/W (Wakefield No. 421, or equivalent)

Fig. 5 – 20-watt audio-amplifier circuit featuring full-complementary-symmetry with Darlington output transistors.

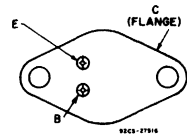
RCA1E02, RCA1E03

Silicon Transistors for Audio-Frequency Linear-Amplifier Applications

RCA1E02 and RCA1E03 are silicon n-p-n and p-n-p transistors, respectively. These complementary devices are especially characterized for audio-amplifier applications. They may be used singly or as a complementary pair in complementary- or quasi-complementary-symmetry circuits, and are particu-

larly useful as drivers or predrivers. They may also be used in audio power amplifiers, linear modulators, servo amplifiers, and operational amplifiers. The units are supplied in the JEDEC TO-66 package.

TERMINAL DESIGNATIONS



MAXIMUM RATINGS, Absolute-Maximum Values:

	RCA1E02	RCA1E03	
COLLECTOR-TO-BASE VOLTAGE V _{CB0}	200	-200	V
COLLECTOR-TO-EMITTER VOLTAGE:			
With base open V _{CEO}	175	-175	V
With external base-to-emitter resistance (R _{BE}) = 100 Ω V _{CER}	200	-200	V
EMITTER-TO-BASE VOLTAGE V _{EBO}	5	-5	V
COLLECTOR CURRENT I _C	2	-2	A
BASE CURRENT I _B	1	-1	A
TRANSISTOR DISSIPATION:			
At case temperatures up to 25°C P _T	35	35	W
At case temperatures above 25°C	Derate linearly to 200°C		
TEMPERATURE RANGE:			
Storage and Operating (Junction)	← -65 to +200 →		°C
PIN TEMPERATURE (During Soldering):			
At distances ≥ 1/32 in. (0.8 mm) from case for 10 s max.	← 230 →		°C

Type RCA1E02

Package: JEDEC TO-66

Construction: Silicon n-p-n

ELECTRICAL CHARACTERISTICS, At Case Temperature (T_C) = 25°C Unless Otherwise Specified

CHARACTERISTIC	TEST CONDITIONS	LIMITS		UNITS
		MIN.	MAX.	
I _{CER}	V _{CE} = 120 V, R _{BE} = 100 Ω	-	100	μA
I _{EBO}	V _{EB} = 5 V, I _C = 0	-	1	mA
V _{CEO}	I _C = 0.1 A, I _B = 0	175	-	V
V _{CER}	I _C = 0.1 A, R _{BE} = 100 Ω	200	-	V
h _{FE}	I _C = 0.3 A, V _{CE} = 2 V	30	150	
V _{BE}	I _C = 0.3 A, V _{CE} = 2 V	-	1	V
I _{S/b}	V _{CE} = 80 V, t = 0.4 s	0.4	-	A

For characteristics curves and test conditions, refer to published data for prototype 2N3583

Type RCA1E03

Package: JEDEC TO-66

Construction: Silicon p-n-p

ELECTRICAL CHARACTERISTICS, At Case Temperature (T_C) = 25°C Unless Otherwise Specified

CHARACTERISTIC	TEST CONDITIONS	LIMITS		UNITS
		MIN.	MAX.	
I _{CER}	V _{CE} = -120 V, R _{BE} = 100 Ω	-	-100	μA
I _{EBO}	V _{EB} = -5 V, I _C = 0	-	-1	mA
V _{CEO}	I _C = -0.1 A, I _B = 0	-175	-	V
V _{CER}	I _C = -0.1 A, R _{BE} = 100 Ω	-200	-	V
h _{FE}	I _C = -0.3 A, V _{CE} = -2 V	30	150	
V _{BE}	I _C = -0.3 A, V _{CE} = -2 V	-	-1	V
I _{S/b}	V _{CE} = -80 V, t = 0.4 s	-0.25	-	A

For characteristics curves and test conditions, refer to published data for prototype 2N6211

RCA410

High-Voltage, High-Power Silicon N-P-N Transistors

For Switching and Linear Applications in Military, Industrial, and Commercial Equipment

RCA-410 is an epitaxial silicon n-p-n power transistor utilizing a multiple-emitter-site structure. This device employs the popular JEDEC TO-3 package. Featuring high breakdown-voltage ratings and low saturation-

voltage values, the RCA-410 is especially suitable for use in inverters, deflection circuits, switching regulators, high-voltage bridge amplifiers, ignition circuits, and other high-voltage switching applications.

Features:

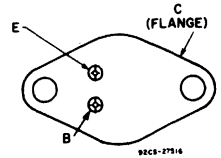
- Maximum safe-area-of-operation curves
- Low saturation voltage: $V_{CE(sat)} = 0.8 \text{ V (max.)}$
- High voltage rating: $V_{CEO(sus)} = 200 \text{ V}$
- High dissipation rating: $P_T = 125 \text{ W}$

MAXIMUM RATINGS, Absolute-Maximum Values:

COLLECTOR-TO-BASE VOLTAGE, V_{CBO}	200 V
COLLECTOR-TO-EMITTER SUSTAINING VOLTAGE With base open, $V_{CEO(sus)}$	200 V
EMITTER-TO-BASE VOLTAGE, V_{EBO}	5 V
COLLECTOR CURRENT: Continuous, I_C	7 A
Peak	10 A
BASE CURRENT (Continuous), I_B	2 A

TRANSISTOR DISSIPATION, P_T At case temperatures up to 25°C and V_{CE} up to 75 V	125 W
At case temperatures up to 25°C and V_{CE} above 75 V	See Fig. 2.
At case temperatures above 25°C and V_{CE} above 75 V	See Figs. 1 & 2.
TEMPERATURE RANGE: Storage & Operating (Junction)	-65 to $+200^\circ\text{C}$
PIN TEMPERATURE (During Soldering): At distances $\geq 1/32$ in. (0.8 mm) from case for 10 s max.	230°C

TERMINAL DESIGNATIONS



JEDEC TO-3

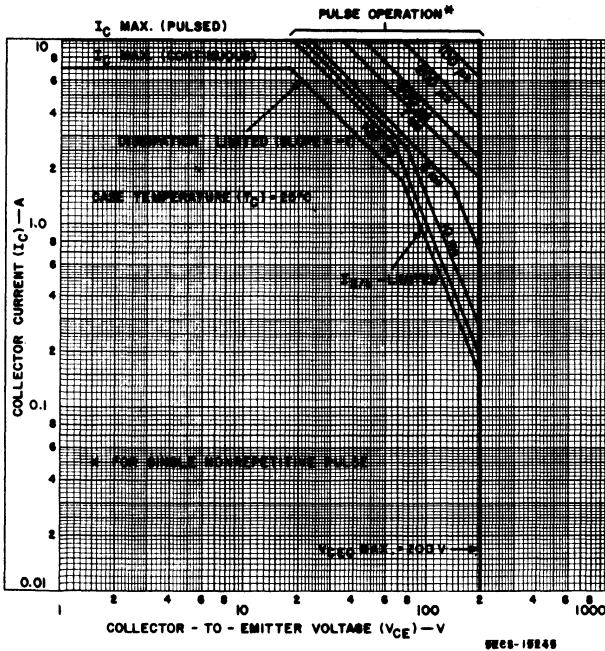


Fig.2—Maximum operating areas.

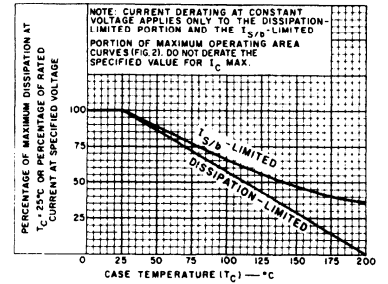


Fig.1—Dissipation and current derating curves.

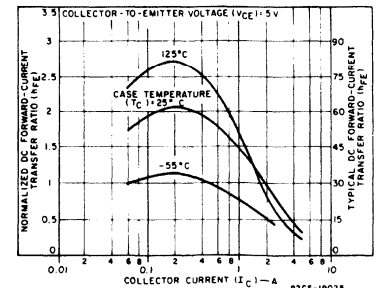


Fig.3—Typical dc beta characteristics.

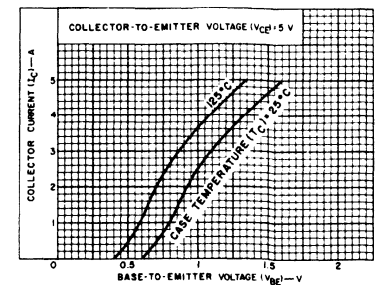


Fig.4—Typical transfer characteristics.

ELECTRICAL CHARACTERISTICS, Case Temperature (T_C) = 25°C Unless Otherwise Specified

Characteristic	Symbol	Test Conditions					Limits			Units
		DC Collector Voltage (V)	DC Emitter or Base Voltage (V)		DC Current (A)		Min.	Typ.	Max.	
		V _{CE}	V _{EB}	V _{BE}	I _C	I _B				
Collector-Cutoff Current With base open	I _{CEO}	300					-	-	0.25	mA
With base-emitter junction reverse-biased	I _{CEV}	300		1.5			-	-	0.25	
With base-emitter junction reverse-biased & T _C 125°C	I _{CEV}	300		-1.5			-	-	0.5	
Emitter-Cutoff Current	I _{EBO}		5						5.0	mA
DC Forward-Current Transfer Ratio	h _{FE}	5			1.0 ^a		30		90	
		5			2.5 ^a		10			
Collector-to-Emitter Sustaining Voltage With base open	V _{CEO(sus)} ^b				0.1		300 ^b			V
Base to Emitter Saturation Voltage	V _{BE(sat)}				1.0 ^a	0.1		0.9	1.5	V
Collector-to-Emitter Saturation Voltage	V _{CE(sat)}				1.0 ^a	0.1		0.2	0.8	V
Second-Breakdown Collector Current (With base forward biased) Pulse duration (non repetitive) 1 s	I _S ^b ^c	150					0.3			A
Gain-Bandwidth Product	f _T	10			0.2			2.5		MHz
Switching Time										
Rise	t _r				1.0	0.1 (I _{B1}) -0.5 (I _{B2})		0.35		μs
Storage	t _s				1.0	0.1 (I _{B1}) 0.5 (I _{B2})		1.4		
Fall	t _f				1.0	0.1 (I _{B1}) -0.5 (I _{B2})		0.15		
Thermal Resistance (Junction-to-Case)	R _{θJC}	10			5				1.4	°C/W

^a Pulsed, pulse duration ≤ 350 μs, duty factor = 2%. ^b CAUTION The sustaining voltage V_{CEO(sus)} MUST NOT be measured on a curve tracer

^c I_S^b is defined as the current at which second breakdown occurs at a specified collector voltage with the emitter base junction forward-biased for transistor operation in the active region.

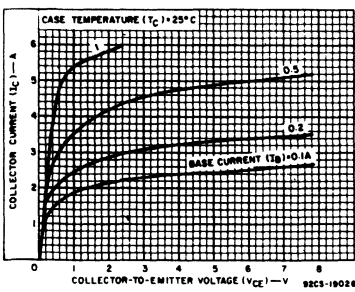


Fig. 5— Typical output characteristics.

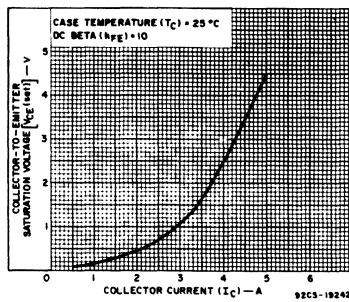


Fig. 6— Typical saturation voltage characteristic.

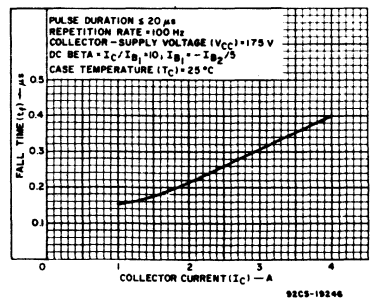


Fig. 7— Typical fall time vs. collector current.

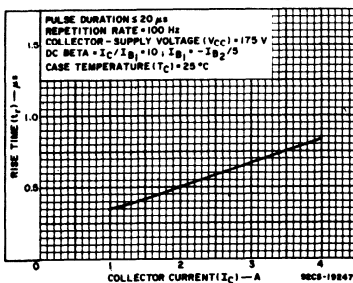


Fig. 8— Typical rise time vs. collector current.

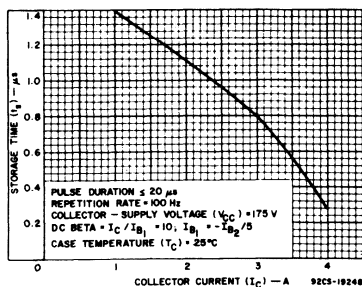


Fig. 9— Typical storage time vs. collector current.

RCA411

High-Voltage, High-Power Silicon N-P-N Power Transistor

For Switching and Linear Applications in Military, Industrial, and Commercial Equipment

RCA-411 is an epitaxial silicon n-p-n power transistor utilizing a multiple-emitter-site structure. This device employs the popular JEDEC TO-3 package. Featuring high breakdown-voltage ratings and low saturation-

voltage values, the RCA-411 is especially suitable for use in inverters, deflection circuits, switching regulators, high-voltage bridge amplifiers, ignition circuits, and other high-voltage switching applications.

Features:

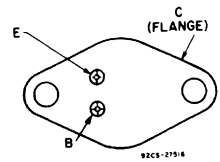
- Maximum safe-area-of-operation curves
- Low saturation voltage: $V_{CE(sat)} = 0.8 \text{ V (max.)}$
- High voltage rating: $V_{CE(sus)} = 300 \text{ V}$
- High dissipation rating: $P_T = 125 \text{ W}$

MAXIMUM RATINGS, Absolute-Maximum Values:

COLLECTOR-TO-BASE VOLTAGE, V_{CBO}	300 V
COLLECTOR-TO-EMITTER SUSTAINING VOLTAGE: With base open, $V_{CEO(sus)}$	300 V
EMITTER-TO-BASE VOLTAGE, V_{EBO}	5 V
COLLECTOR CURRENT: Continuous, I_C	7 A
Peak	10 A

BASE CURRENT (Continuous), I_B	2 A
TRANSISTOR DISSIPATION, P_T : At case temperatures up to 25°C and V_{CE} up to 75 V	125 W
At case temperatures up to 25°C and V_{CE} above 75 V	See Fig. 2.
At case temperatures above 25°C and V_{CE} above 75 V	See Figs. 1 & 2.
TEMPERATURE RANGE: Storage & Operating (Junction)	-85 to +200 °C
PIN TEMPERATURE (During Soldering): At distances $\geq 1/32$ in. (0.8 mm) from case for 10 s max.	230 °C

TERMINAL DESIGNATIONS



JEDEC TO-3

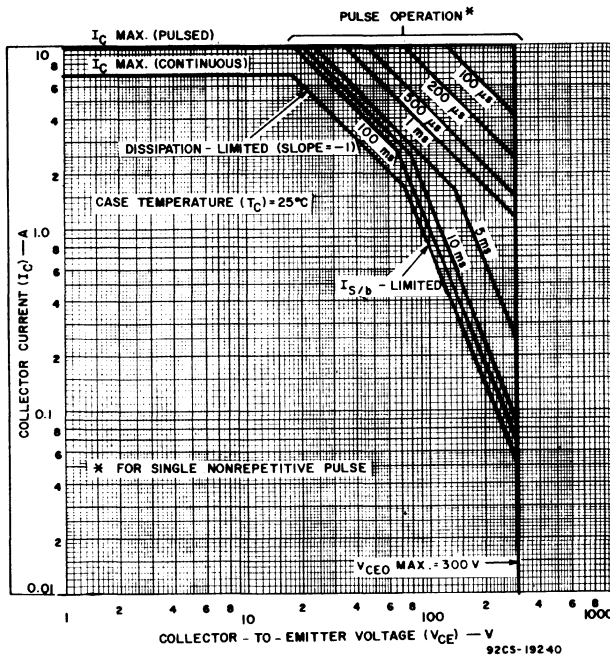
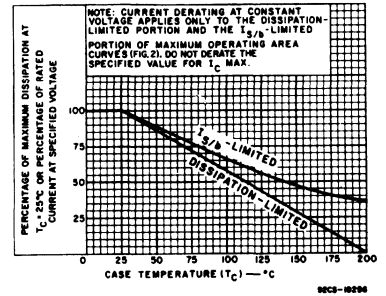


Fig. 2—Maximum operating areas.

Fig. 1—Dissipation and current derating curves.

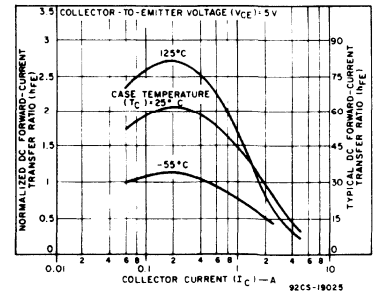


Fig. 3—Typical dc beta characteristics.

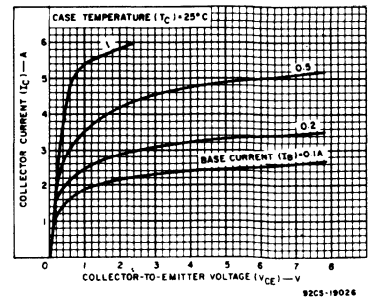


Fig. 4—Typical output characteristics.

ELECTRICAL CHARACTERISTICS, Case Temperature (T_C) = 25°C Unless Otherwise Specified

Characteristic	Symbol	Test Conditions					Limits			Units
		DC Collector Voltage (V)	DC Emitter or Base Voltage (V)		DC Current (A)		Min.	Typ.	Max.	
		V_{CE}	V_{EB}	V_{BE}	I_C	I_B				
Collector Cutoff Current With base open	I_{CEO}	300					-	0.25	mA	
With base-emitter junction reverse biased	I_{CEV}	300		1.5			-	0.25		
With base-emitter junction reverse-biased & $T_C = 125^\circ\text{C}$	I_{CEV}	300		1.5			-	0.5		
Emitter Cutoff Current	I_{EBO}		5					5.0	mA	
DC Forward Current Transfer Ratio	h_{FE}	5			1.0 ^a 2.5 ^a		30 10	90		
Collector to Emitter Sustaining Voltage With base open	$V_{CEO(sus)}^b$				0.1		300 ^b		V	
Base to Emitter Saturation Voltage	$V_{BE(sat)}$				1.0 ^a	0.1		0.9 1.5	V	
Collector to Emitter Saturation Voltage	$V_{CE(sat)}$				1.0 ^a	0.1		0.2 0.8	V	
Second Breakdown Collector Current (With base forward biased) Pulse duration (non-repetitive) 1 s	$I_{S B}^c$	150					0.3		A	
Gain Bandwidth Product	f_T	10			0.2		25		MHz	
Switching Time Rise	t_r				1.0	0.1 (I_{B1}) -0.5 (I_{B2})		0.35	μs	
Storage	t_s				1.0	0.1 (I_{B1}) 0.5 (I_{B2})		1.4		
Fall	t_f				1.0	0.1 (I_{B1}) -0.5 (I_{B2})		0.15		
Thermal Resistance (Junction-to-Case)	$R_{\theta JC}$	10			5			1.4	$^\circ\text{C}/\text{W}$	

^a Pulsed, pulse duration $\leq 350 \mu\text{s}$, duty factor $\sim 2\%$. ^b CAUTION: The sustaining voltage $V_{CEO(sus)}$ MUST NOT be measured on a curve tracer. ^c $I_{S B}$ is defined as the current at which second breakdown occurs at a specified collector voltage with the emitter-base junction forward biased for transistor operation in the active region.

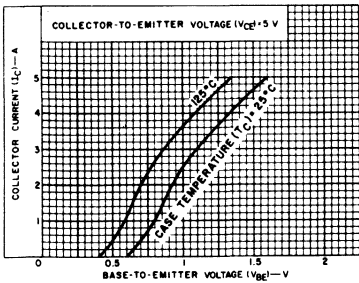


Fig. 5—Typical transfer characteristics.

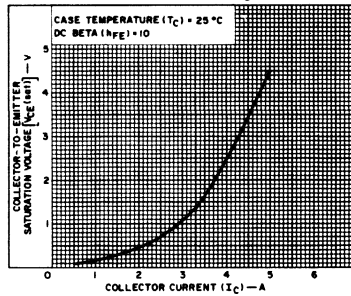


Fig. 6—Typical saturation voltage characteristic.

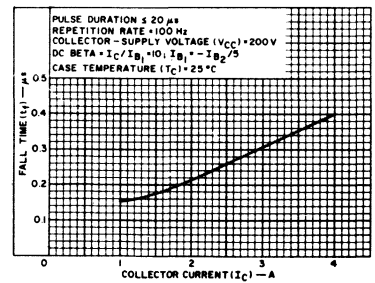


Fig. 7—Typical fall time vs. collector current.

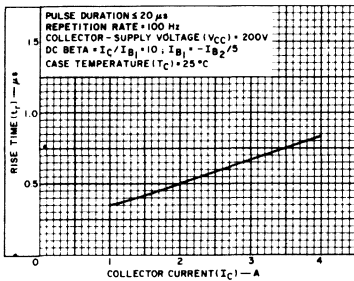


Fig. 8—Typical rise time vs. collector current.

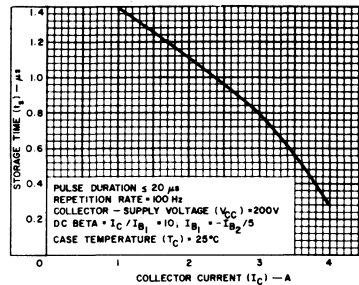


Fig. 9—Typical storage time vs. collector current.

RCA413

High-Voltage, High-Power Silicon N-P-N Power Transistor

For Switching and Linear Applications in Military, Industrial, and Commercial Equipment

RCA-413 is an epitaxial silicon n-p-n power transistor utilizing a multiple-emitter-site structure. This device employs the popular JEDEC TO-3 package. Featuring high breakdown-voltage ratings and low saturation-

voltage values, the RCA-413 is especially suitable for use in inverters, deflection circuits, switching regulators, high-voltage bridge amplifiers, ignition circuits, and other high-voltage switching applications.

Features:

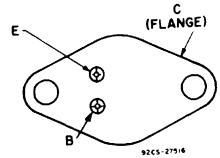
- Maximum safe-area-of-operation curves
- Low saturation voltage: $V_{CE(sat)} = 0.8 \text{ V (max.)}$
- High voltage rating: $V_{CE0(sus)} = 325 \text{ V}$
- High dissipation rating: $P_T = 125 \text{ W}$

MAXIMUM RATINGS, Absolute-Maximum Values:

COLLECTOR-TO-BASE VOLTAGE, V_{CBO}	400 V
COLLECTOR-TO-EMITTER SUSTAINING VOLTAGE With base open, $V_{CE0(sus)}$	325 V
COLLECTOR-TO-EMITTER BREAKDOWN VOLTAGE: With base open, $V_{(BR)CEO}$	400 V
EMITTER-TO-BASE VOLTAGE, V_{EBO}	5 V
COLLECTOR CURRENT: Continuous, I_C	7 A
Peak	10 A

BASE CURRENT (Continuous), I_B	2 A
TRANSISTOR DISSIPATION, P_T : At case temperatures up to 25°C and V_{CE} up to 75 V	125 W
At case temperatures up to 25°C and V_{CE} above 75 V	See Fig. 2.
At case temperatures above 25°C and V_{CE} above 75 V	See Figs. 1 & 2.
TEMPERATURE RANGE: Storage & Operating (Junction)	-65 to +200 °C
PIN TEMPERATURE (During Soldering): At distances $\geq 1/32$ in. (0.8 mm) from case for 10 s max.	230 °C

TERMINAL DESIGNATIONS



JEDEC TO-3

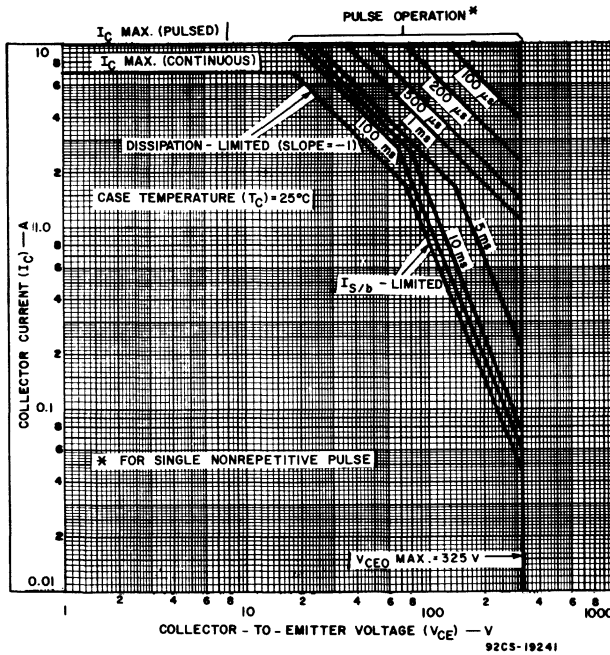


Fig. 2—Maximum operating areas.

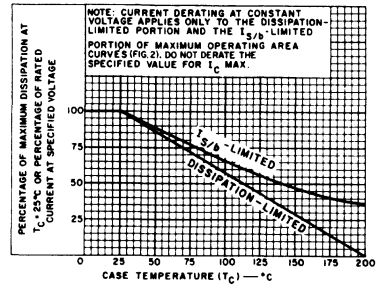


Fig. 1—Dissipation and current derating curves.

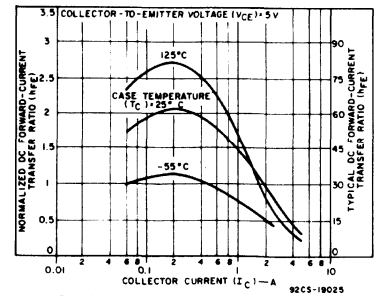


Fig. 3—Typical dc beta characteristics.

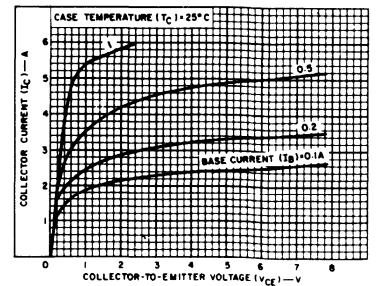


Fig. 4—Typical output characteristics.

RCA413

ELECTRICAL CHARACTERISTICS, Case Temperature (T_C) = 25°C Unless Otherwise Specified

Characteristic	Symbol	Test Conditions					Limits			Units
		DC Collector Voltage (V)	DC Emitter or Base Voltage (V)		DC Current (A)		Min.	Typ.	Max.	
		V_{CE}	V_{EB}	V_{BE}	I_C	I_B				
Collector Cutoff Current With base open	I_{CEO}	300					-	-	0.25	mA
With base-emitter junction reverse-biased	I_{CEV}	300		1.5					0.25	
With base-emitter junction reverse-biased & $T_C = 125^\circ\text{C}$	I_{CEV}	300		1.5					0.5	
Emitter Cutoff Current	I_{EBO}		5						5.0	mA
DC Forward Current Transfer Ratio	h_{FE}	5			1.0 ^a		30		90	
		5			2.5 ^a		10			
Collector to Emitter Sustaining Voltage With base open	$V_{CE(sus)}^b$				0.1		300 ^b			V
Base to Emitter Saturation Voltage	$V_{BE(sat)}$				1.0 ^a	0.1		0.9	1.5	V
Collector to Emitter Saturation Voltage	$V_{CE(sat)}$				1.0 ^a	0.1		0.2	0.8	V
Second Breakdown Collector Current (With base forward biased) Pulse duration (non-repetitive) 1 s	I_{S2}^c	150					0.3			A
Gain Bandwidth Product	f_T	10			0.2			2.5		MHz
Switching Time										
Rise	t_r				1.0	0.1 (I_{B1}) 0.5 (I_{B2})		0.35		μs
Storage	t_s				1.0	0.1 (I_{B1}) 0.5 (I_{B2})		1.4		
Fall	t_f				1.0	0.1 (I_{B1}) 0.5 (I_{B2})		0.15		
Thermal Resistance (Junction-to-Case)	$R_{\theta JC}$	10			5				1.4	$^\circ\text{C/W}$

^a Pulsed, pulse duration $\leq 350 \mu\text{s}$, duty factor = 2%. ^b CAUTION: The sustaining voltage $V_{CE(sus)}$ MUST NOT be measured on a curve tracer.
^c I_{S2} is defined as the current at which second breakdown occurs at a specified collector voltage with the emitter-base junction forward biased for transistor operation in the active region.

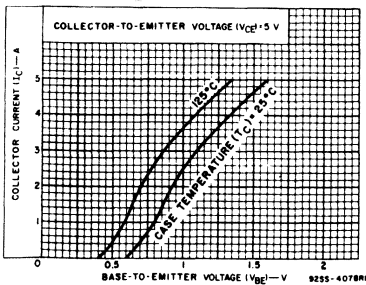


Fig. 5—Typical transfer characteristics.

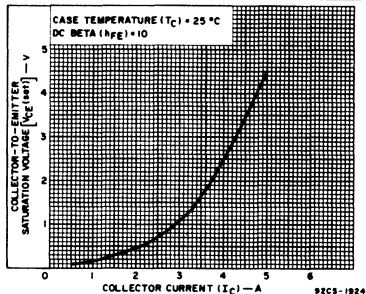


Fig. 6—Typical saturation voltage characteristic.

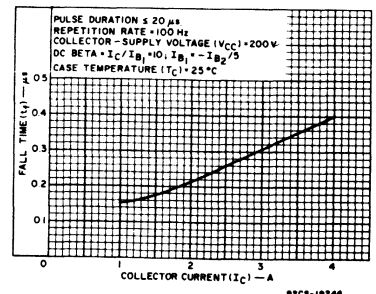


Fig. 7—Typical fall time vs. collector current.

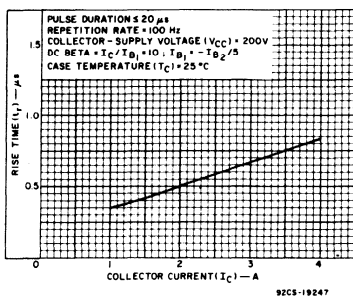


Fig. 8—Typical rise time vs. collector current.

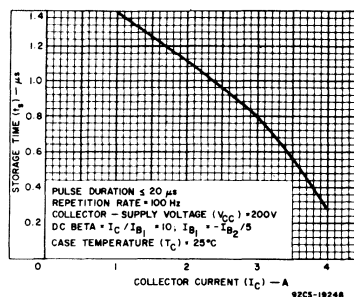


Fig. 9—Typical storage time vs. collector current.

RCA423

High-Voltage, High-Power Silicon N-P-N Power Transistor

For Switching and Linear Applications in Military, Industrial, and Commercial Equipment

RCA-423 is an epitaxial silicon n-p-n power transistor utilizing a multiple-emitter-site structure. This device employs the popular JEDEC TO-3 package. Featuring high breakdown-voltage ratings and low saturation-

voltage values, the RCA-423 is especially suitable for use in inverters, deflection circuits, switching regulators, high-voltage bridge amplifiers, ignition circuits, and other high-voltage switching applications.

Features:

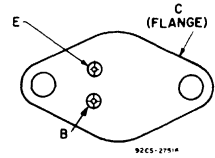
- Maximum safe-area-of-operation curves
- Low saturation voltage: $V_{CE(sat)} = 0.8 \text{ V (max.)}$
- High voltage rating: $V_{CE(sus)} = 325 \text{ V}$
- High dissipation rating: $P_T = 125 \text{ W}$

MAXIMUM RATINGS, Absolute-Maximum Values:

COLLECTOR-TO-BASE VOLTAGE, V_{CBO}	400 V
COLLECTOR-TO-EMITTER SUSTAINING VOLTAGE: With base open, $V_{CE(sus)}$	325 V
COLLECTOR-TO-EMITTER BREAKDOWN VOLTAGE: With base open, $V_{(BR)CEO}$	400 V
EMITTER-TO-BASE VOLTAGE, V_{EBO}	5 V
COLLECTOR CURRENT: Continuous, I_C	7 A
Peak, I_C	10 A

BASE CURRENT (Continuous), I_B	2 A
TRANSISTOR DISSIPATION, P_T : At case temperatures up to 25°C and V_{CE} up to 75 V	125 W
At case temperatures up to 25°C and V_{CE} above 75 V	See Fig. 2.
At case temperatures above 25°C and V_{CE} above 75 V	See Figs. 1 & 2.
TEMPERATURE RANGE: Storage & Operating (Junction)	-65 to +200 °C
PIN TEMPERATURE (During Soldering): At distances $\geq 1/32$ in. (0.8 mm) from case for 10 s max.	230 °C

TERMINAL DESIGNATIONS



JEDEC TO-3

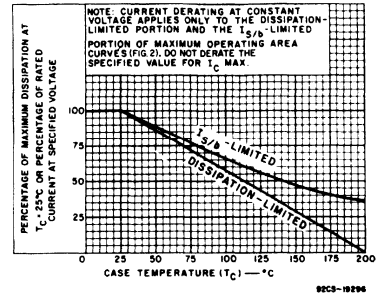


Fig.1—Dissipation and current derating curves.

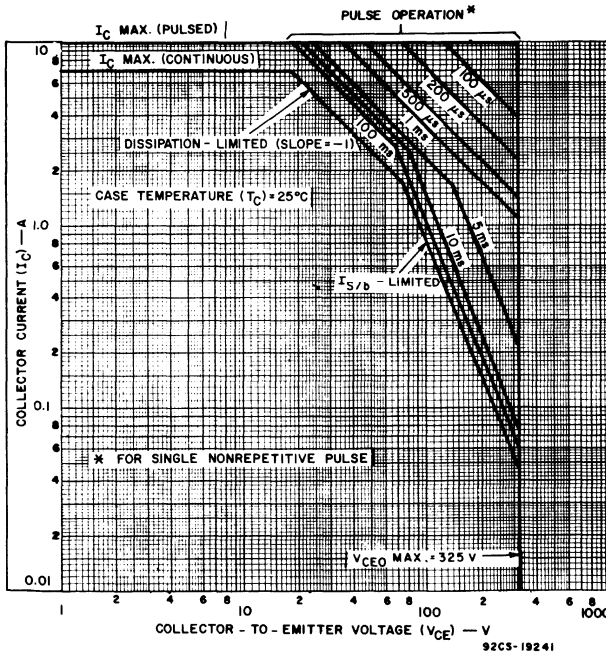


Fig.2—Maximum operating areas.

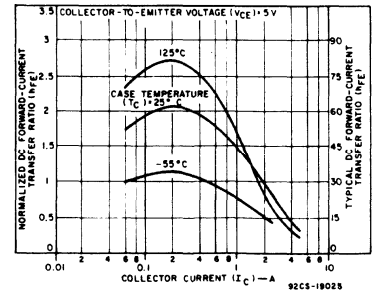


Fig.3—Typical dc beta characteristics.

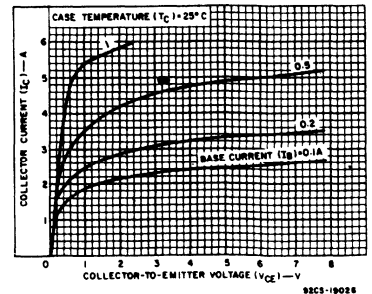


Fig.4—Typical output characteristics.

RCA423

ELECTRICAL CHARACTERISTICS, Case Temperature (T_C) = 25°C Unless Otherwise Specified

Characteristic	Symbol	Test Conditions					Limits			Units
		DC Collector Voltage (V)	DC Emitter or Base Voltage (V)		DC Current (A)		Min.	Typ.	Max.	
		V_{CE}	V_{EB}	V_{BE}	I_C	I_B				
Collector Cutoff Current With base open	I_{CEO}	300						0.25	mA	
With base emitter junction reverse biased	I_{CEV}	300		1.5				0.25		
With base emitter junction reverse biased & T_C 125°C	I_{CEV}	300		1.5				0.5		
Emitter Cutoff Current	I_{EBO}		5					5.0	mA	
DC Forward Current Transfer Ratio	h_{FE}	5			1.0 ^a		30	90		
		5			2.5 ^a		10			
Collector to Emitter Sustaining Voltage With base open	$V_{CEO(sus)}^b$				0.1		300 ^b		V	
Base to Emitter Saturation Voltage	$V_{BE(sat)}$				1.0 ^a	0.1	0.9	1.5	V	
Collector to Emitter Saturation Voltage	$V_{CE(sat)}$				1.0 ^a	0.1	0.2	0.8	V	
Second Breakdown Collector Current (With base forward biased) Pulse duration (non repetitive) 1 s	$I_{S B}^c$	150					0.3		A	
Gain Bandwidth Product	f_T	10			0.2		2.5		MHz	
Switching Time Rise	t_r				1.0	0.1 (I_{B1}) 0.5 (I_{B2})	0.35		μs	
Storage	t_s				1.0	0.1 (I_{B1}) 0.5 (I_{B2})	1.4			
Fall	t_f				1.0	0.1 (I_{B1}) 0.5 (I_{B2})	0.15			
Thermal Resistance (Junction to Case)	$R_{\theta JC}$	10			5			1.4	°C/W	

^a Pulsed; pulse duration $\leq 350 \mu s$, duty factor = 2%. ^b CAUTION: The sustaining voltage $V_{CEO(sus)}$ MUST NOT be measured on a curve tracer.

^c $I_{S B}$ is defined as the current at which second breakdown occurs at a specified collector voltage with the emitter base junction forward biased for transistor operation in the active region.

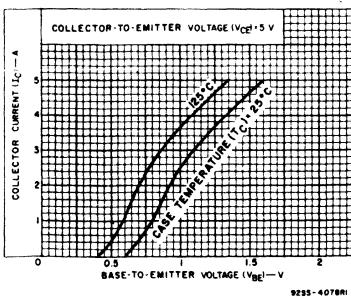


Fig. 5—Typical transfer characteristics.

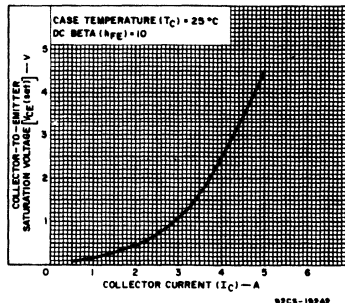


Fig. 6—Typical saturation voltage characteristic.

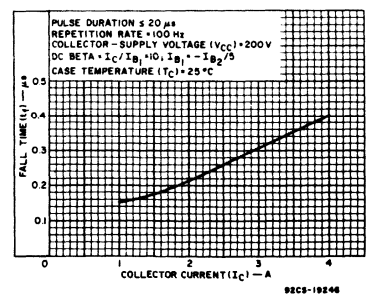


Fig. 7—Typical fall time vs. collector current.

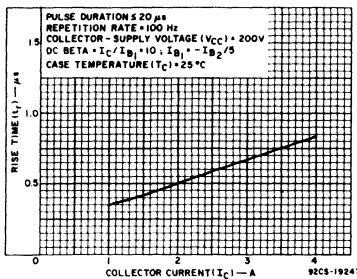


Fig. 8—Typical rise time vs. collector current.

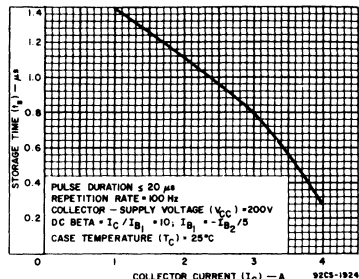


Fig. 9—Typical storage time vs. collector current.

RCA431

High-Voltage, High-Power Silicon N-P-N Power Transistor

For Switching and Linear Applications in Military, Industrial, and Commercial Equipment

RCA-431 is an epitaxial silicon n-p-n power transistor utilizing a multiple-emitter-site structure. This device employs the popular JEDEC TO-3 package. Featuring high breakdown-voltage ratings and low saturation-

voltage values, the RCA-431 is especially suitable for use in inverters, deflection circuits, switching regulators, high-voltage bridge amplifiers, ignition circuits, and other high-voltage switching applications.

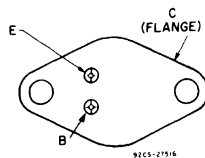
Features:

- Maximum safe-area-of operation curves
- Low saturation voltage: $V_{CE(sat)} = 0.7 V$ (max.)
- High voltage rating: $V_{CEO(sus)} = 325 V$
- High dissipation rating: $P_T = 125 W$

MAXIMUM RATINGS, Absolute-Maximum Values:

COLLECTOR-TO-BASE VOLTAGE, V_{CBO}	400 V	TRANSISTOR DISSIPATION, P_T :	
COLLECTOR-TO-EMITTER SUSTAINING VOLTAGE With base open, $V_{CEO(sus)}$	325 V	At case temperatures up to 25°C and V_{CE} up to 75 V	125 W
COLLECTOR-TO-EMITTER BREAKDOWN VOLTAGE: With base open, $V_{(BR)CEO}$	400 V	At case temperatures up to 25°C and V_{CE} above 75 V	See Fig. 2.
EMITTER-TO-BASE VOLTAGE, V_{EBD}	5 V	At case temperatures above 25°C and V_{CE} above 75 V	See Figs. 1 & 2.
COLLECTOR CURRENT: Continuous, I_C	7 A	TEMPERATURE RANGE: Storage & Operating (Junction)	-65 to +200 °C
Peak	10 A	PIN TEMPERATURE (During Soldering): At distances $\geq 1/32$ in. (0.8 mm) from case for 10 s max.	230 °C
BASE CURRENT (Continuous), I_B	2 A		

TERMINAL DESIGNATIONS



JEDEC TO-3

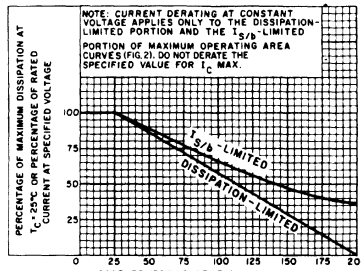


Fig. 1—Dissipation and current derating curves.

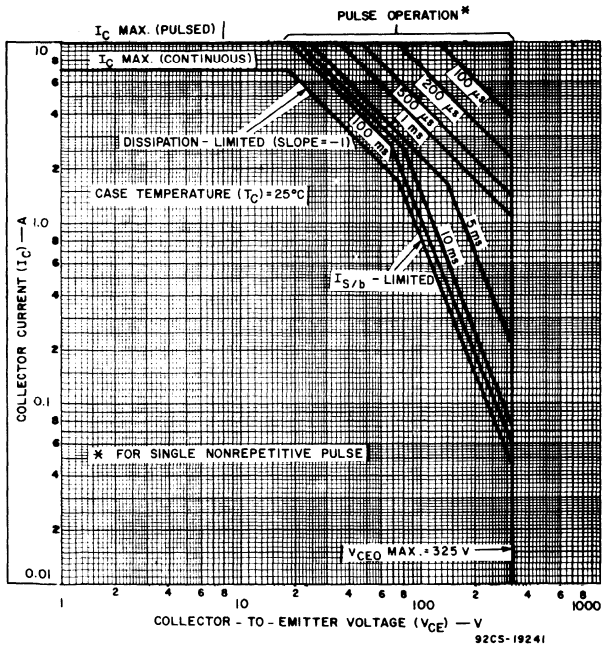


Fig. 2—Maximum operating areas.

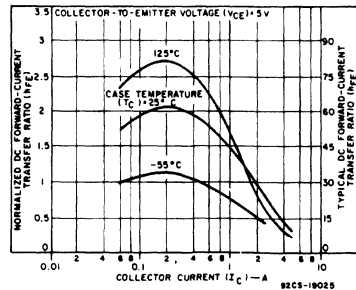


Fig. 3—Typical dc beta characteristics.

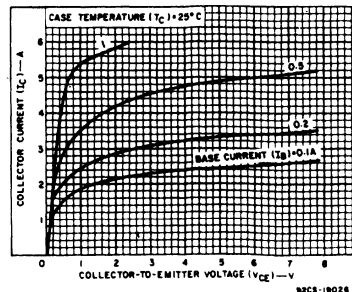


Fig. 4—Typical output characteristics.

RCA431

ELECTRICAL CHARACTERISTICS, Case Temperature (T_C) = 25°C Unless Otherwise Specified

Characteristic	Symbol	Test Conditions					Limits			Units	
		DC Collector Voltage (V)		DC Emitter or Base Voltage (V)		DC Current (A)		Min.	Typ.		Max.
		V_{CE}	V_{EB}	V_{BE}	I_C	I_B					
Collector Cutoff Current With base open	I_{CEO}	300					-	-	0.25	mA	
With base-emitter junction reverse-biased	I_{CEV}	300		1.5			-	-	0.25		
With base-emitter junction reverse-biased & $T_C = 125^\circ\text{C}$	I_{CEV}	300		-1.5			-	-	0.5		
Emitter-Cutoff Current	I_{EBO}		5				-	-	5.0	mA	
DC Forward Current Transfer Ratio	h_{FE}	5			1.0 ^a		30		90		
		5			2.5 ^a		10		-		
Collector-to-Emitter Sustaining Voltage With base open	$V_{CE(sus)}^b$				0.1		300 ^b			V	
Base to Emitter Saturation Voltage	$V_{BE(sat)}$				1.0 ^a	0.1	-	0.9	1.5	V	
Collector to Emitter Saturation Voltage	$V_{CE(sat)}$				1.0 ^a	0.1	-	0.2	0.8	V	
Second-Breakdown Collector Current (With base forward biased) Pulse duration (non-repetitive) 1 s	$I_{S,b}^c$	150					0.3			A	
Gain-Bandwidth Product	f_T	10			0.2		-	2.5		MHz	
Switching Time Rise	t_r				1.0	0.1 (I_{B1}) -0.5 (I_{B2})		0.35		μs	
Storage	t_s				1.0	0.1 (I_{B1}) 0.5 (I_{B2})		1.4			
Fall	t_f				1.0	0.1 (I_{B1}) -0.5 (I_{B2})		0.15			
Thermal Resistance (Junction-to-Case)	$R_{\theta JC}$	10			5			-	1.4	$^\circ\text{C/W}$	

^a Pulsed, pulse duration $\leq 350 \mu\text{s}$, duty factor = 2%. ^b CAUTION: The sustaining voltage $V_{CE(sus)}$ MUST NOT be measured on a curve tracer. ^c $I_{S,b}$ is defined as the current at which second breakdown occurs at a specified collector voltage with the emitter base junction forward biased for transistor operation in the active region.

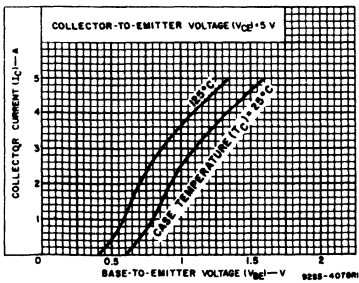


Fig. 5—Typical transfer characteristics.

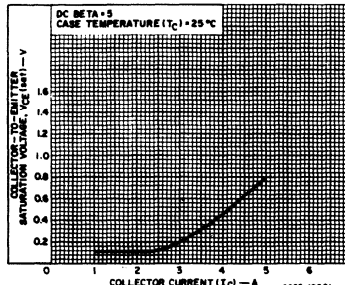


Fig. 6—Saturation voltage vs. collector current.

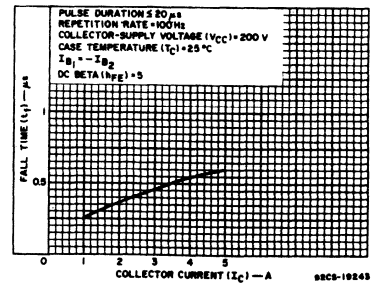


Fig. 7—Typical fall-time characteristic.

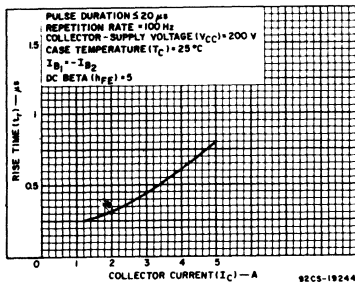


Fig. 8—Typical rise-time characteristic.

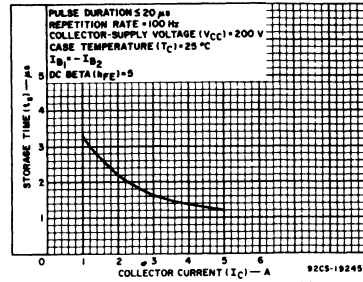


Fig. 9—Typical storage-time characteristic (with constant forced gain).

RCA8766 Series

10-Ampere N-P-N Monolithic Darlington Power Transistors

350, 400, 450 Volts, 150 Watts

Gain of 100 at 4, 6A

The RCA-8766 Series[®] are monolithic n-p-n silicon Darlington transistors designed for automotive electronic power applications. The pi-nu construction of these devices provides good forward and reverse second-breakdown capability; their high gain makes it possible for them to be driven directly from integrated circuits.

The devices in the series differ primarily in voltage ratings and in the current at which the dc gain is specified.

The RCA-8766 Series are supplied in the JEDEC TO-3 hermetic steel package.

• Formerly RCA Dev. Nos. TA8766 Series.

Features:

- Operates from IC without predriver
- Low leakage at high temperature
- High reverse second-breakdown capability

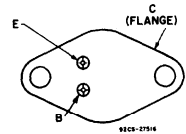
Applications:

- Power switching
- Solenoid drivers
- Automotive Ignition
- Series and shunt regulators

MAXIMUM RATINGS, Absolute-Maximum Values:

	RCA8766 RCA8766A	RCA8766B RCA8766C	RCA8766D RCA8766E	
V _{CBO}	350	400	450	V
V _{CER} (sus) R _{BE} = 50 Ω	350	400	450	V
V _{CEO} (sus)	350	400	450	V
V _{EBO}	5	5	5	V
I _C	10	10	10	A
I _{CM}	15	15	15	A
I _B	1	1	1	A
P _T T _C ≤ 25°C	150	150	150	W
T _C > 25°C	derate linearly 1			°C/W
T _{stg} , T _J	-65 to +175			°C
T _L At distances ≥ 1/8 in. (3.17 mm) from case for 10 s max.	235			°C

TERMINAL DESIGNATIONS



JEDEC TO-3

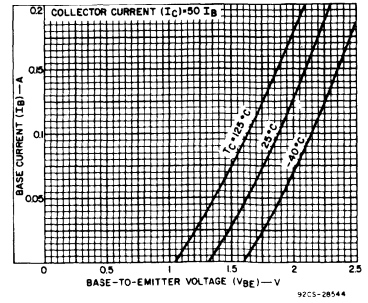
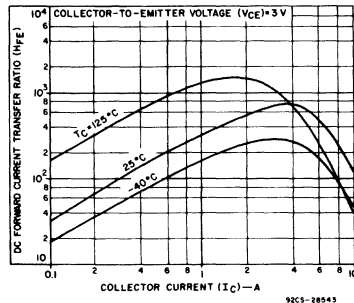
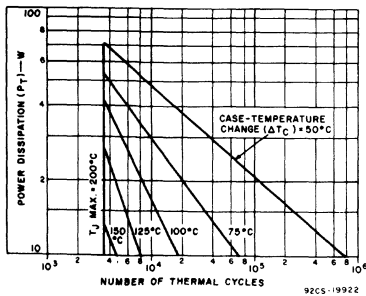


Fig. 1 — Thermal-cycling rating chart for all types. Fig. 2 — Typical DC beta characteristics for all types. Fig. 3 — Typical input characteristics for all types.

RCA8766 Series

ELECTRICAL CHARACTERISTICS, at Case Temperature (T_C) 25°C unless otherwise specified

CHARACTERISTIC	TEST CONDITIONS			LIMITS						UNITS
	VOLTAGE V dc	CURRENT A dc		RCA8766 RCA8766A		RCA8766B RCA8766C		RCA8766D RCA8766E		
	V_{CE}	I_C	I_B	Min.	Max.	Min.	Max.	Min.	Max.	
I_{CER} $R_{BE} = 50 \Omega$ $T_C = 150^\circ C$	350			—	1	—	—	—	—	mA
	400			—	—	—	1	—	—	
	450			—	—	—	—	—	1	
	350			—	10	—	—	—	—	
	400			—	—	—	10	—	—	
	450			—	—	—	—	—	10	
I_{EBO} $V_{BE} = -5 V$		0		—	60	—	60	—	60	mA
$V_{CEO(sus)}$		0.2 ^a	0	350	—	400	—	450	—	V
h_{FE} RCA8766 RCA8766A RCA8766B RCA8766C RCA8766D RCA8766E	3	6 ^a		100	—	—	—	—	—	
	3	4 ^a		100	—	—	—	—	—	
	3	6 ^a		—	—	100	—	—	—	
	3	4 ^a		—	—	100	—	—	—	
	3	6 ^a		—	—	—	—	100	—	
	3	4 ^a		—	—	—	—	100	—	
V_{BE} RCA8766 RCA8766A RCA8766B RCA8766C RCA8766D RCA8766E	3	6 ^a		—	2.5	—	—	—	—	V
	3	4 ^a		—	2.5	—	—	—	—	
	3	6 ^a		—	—	—	2.5	—	—	
	3	4 ^a		—	—	—	2.5	—	—	
	3	6 ^a		—	—	—	—	—	2.5	
	3	4 ^a		—	—	—	—	—	2.5	
$V_{CE(sat)}$ RCA8766 RCA8766A RCA8766B RCA8766C RCA8766D RCA8766E All Types		6 ^a	0.2 ^a	—	1.5	—	—	—	—	V
		4 ^a	0.133 ^a	—	1.5	—	—	—	—	
		6 ^a	0.2 ^a	—	—	—	1.5	—	—	
		4 ^a	0.133 ^a	—	—	—	1.5	—	—	
		6 ^a	0.2 ^a	—	—	—	—	—	1.5	
		4 ^a	0.133 ^a	—	—	—	—	—	1.5	
		8 ^a	0.5 ^a	—	2.5	—	2.5	—	2.5	
V_F		7 ^a		—	2	—	2	—	2	V
$ h_{fe} $ $f = 1 \text{ MHz}$	5	1		10	—	10	—	10	—	
$I_{S/b}$ $t = 1 \text{ s, nonrep.}$	30			5	—	5	—	5	—	A
$R_{\theta JC}$				—	1	—	1	—	1	°C/W

^a Pulsed: Pulse duration = 300 μ s, duty factor = 1.8%.

RCA8766 Series

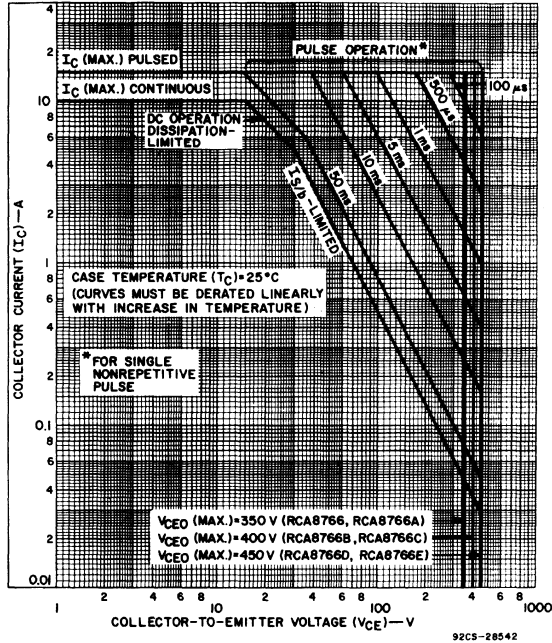


Fig. 4 - Maximum operating areas for all types.

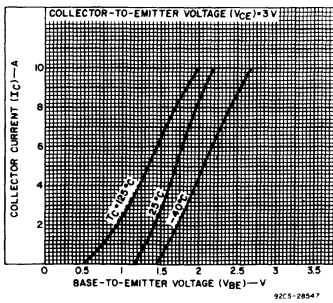


Fig. 5 - Typical transfer characteristics for all types.

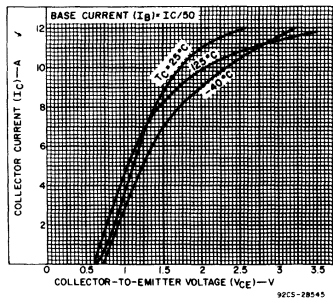


Fig. 6 - Typical output characteristics for all types.

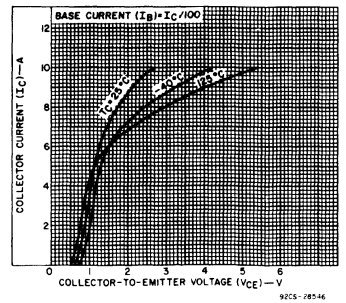


Fig. 7 - Typical output characteristics for all types.

RCP111, RCP113, RCP115, RCP117 Series

High-Voltage, Medium-Power Silicon N-P-N Power Transistors

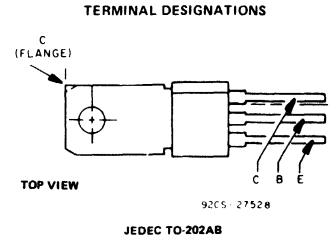
For TV Video Output and Linear-Amplifier Applications

The RCP111-, RCP113, RCP115-, and RCP117-series power transistors are double-diffused, epitaxial-collector silicon n-p-n transistors with planar junctions and field-shield construction. These transistors are designed especially for TV applications such as RGB output, chroma

output, and video output. They are also suitable for use in regulators, audio output and amplifier circuits, and electrostatic deflection in display circuits. The devices are supplied in the JEDEC TO-202AB VERSATAB molded plastic package.

Features:

- Thermal-cycling ratings
- Maximum safe-area-of-operation curves
- High gain-bandwidth product: $f_T = 80 \text{ MHz typ.}$



MAXIMUM RATINGS, Absolute-Maximum Values:

COLLECTOR-TO-EMITTER SUSTAINING VOLTAGE:

With base open $V_{CE0}(\text{sus})$
 EMITTER-TO-BASE VOLTAGE V_{EBO}
 CONTINUOUS COLLECTOR CURRENT I_C
 CONTINUOUS BASE CURRENT I_B
 TRANSISTOR DISSIPATION: P_T
 At case temperatures up to 25°C
 At ambient temperatures up to 25°C
 For pulse operation

	RCP111D	RCP111C	RCP111B	RCP111A	RCP115B	RCP115	
	RCP113D	RCP113C	RCP113B	RCP113A	RCP117B	RCP117	
$V_{CE0}(\text{sus})$	350	300	250	200	250	100	V
V_{EBO}	7	7	7	7	5	5	V
I_C	150	150	150	150	150	150	mA
I_B	50	50	50	50	50	50	mA
P_T	6.25	6.25	6.25	6.25	6.25	6.25	W
	1.56	1.56	1.56	1.56	1.56	1.56	W
	See Fig. 7						
TEMPERATURE RANGE:							
Storage & Operating (Junction)	-65 to 150						°C
LEAD TEMPERATURE (During Soldering):							
At distances $\geq 1/16$ in. (1.39 mm) from case for 10 s max.	230						°C

TEMPERATURE RANGE:

Storage & Operating (Junction)
 LEAD TEMPERATURE (During Soldering):
 At distances $\geq 1/16$ in. (1.39 mm) from case for 10 s max.

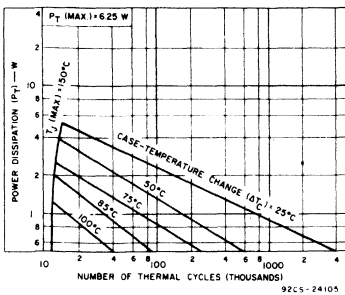


Fig. 1 - Thermal-cycling rating chart for all types.

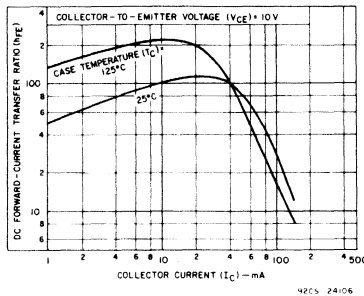


Fig. 2 - Typical dc beta characteristics for all types.

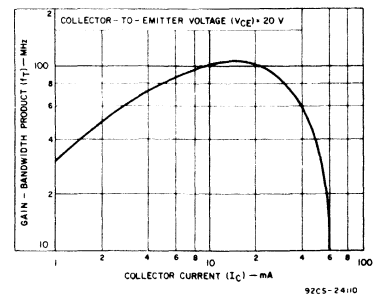


Fig. 3 - Typical gain-bandwidth product for all types.

RCP111, RCP113, RCP115, RCP117 Series

ELECTRICAL CHARACTERISTICS, At Case Temperature, $T_C = 25^\circ\text{C}$ Unless Otherwise Specified

CHARACTERISTIC	TEST CONDITIONS					LIMITS						UNITS		
	VOLTAGE V dc			CURRENT mA dc		RCP111A RCP113A		RCP111B RCP113B		RCP111C RCP113C			RCP111D RCP113D	
	V _{CB}	V _{CE}	V _{BE}	I _C	I _B	MIN.	MAX.	MIN.	MAX.	MIN.	MAX.		MIN.	MAX.
I _{CBO}	350 300 250 200					-	-	-	-	-	-	-	1	μA
I _{CEO}		250 200 175 150			0 0 0 0	-	-	-	-	-	5	-	-	μA
I _{EBO}			6	0		-	10	-	10	-	10	-	10	μA
h _{FE}		10		25 ^a		50	300	50	300	50	300	50	300	
		10		1 ^a		25	-	25	-	25	-	25	-	
	RCP111 Series													
	RCP113 Series													
		10		25 ^a		30	150	30	150	30	150	30	150	
		10		1 ^a		15	-	15	-	15	-	15	-	
V _{CEO(sus)} ^b				20 ^a	0	200	-	250	-	300	-	350	-	V
V _{BE}		10		25 ^a		-	0.8	-	0.8	-	0.8	-	0.8	V
V _{(BR)EBO} (I _E = 1 mA)				0		7	-	7	-	7	-	7	-	V
V _{CE(sat)}				25 ^a	2.5	-	1	-	1	-	1	-	1	V
h _{fe} (f = 20 MHz)		20		15		4 (typ.)		4 (typ.)		4 (typ.)		4 (typ.)		
f _T		20		15		80 (typ.)		80 (typ.)		80 (typ.)		80 (typ.)		MHz
I _{S/b} (t = 0.05 s)		100				100	-	100	-	100	-	100	-	mA
C _{cb} (I _E = 0)		20		25		-	2.25	-	2.25	-	2.25	-	2.25	pF
R _{θJC}						-	20	-	20	-	20	-	20	°C/W
R _{θJA}						-	80	-	80	-	80	-	80	°C/W

^a Pulsed, pulse duration = 300 μs, duty factor ≤ 2%.

^b CAUTION: Sustaining voltage, V_{CEO(sus)}, MUST NOT be measured on a curve tracer.

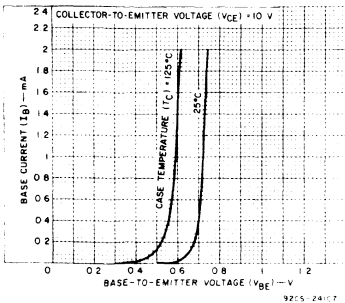


Fig. 4 – Typical input characteristics for all types.

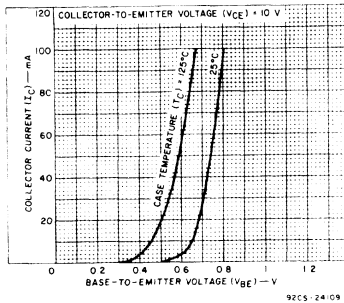


Fig. 5 – Typical transfer characteristics for all types.

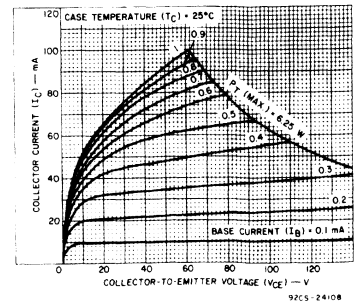


Fig. 6 – Typical output characteristics for all types.

RCP111, RCP113, RCP115, RCP117 Series

ELECTRICAL CHARACTERISTICS, At Case Temperature, $T_C = 25^\circ\text{C}$ Unless Otherwise Specified

CHARACTERISTIC	TEST CONDITIONS					LIMITS								UNITS
	VOLTAGE			CURRENT		RCP115		RCP115B		RCP117		RCP117B		
	V dc			mA dc		MIN.	MAX.	MIN.	MAX.	MIN.	MAX.	MIN.	MAX.	
	V_{CB}	V_{CE}	V_{BE}	I_C	I_B									
I_{CBO}	250 100					-	-	-	50	-	-	-	50	μA
I_{CEO}		175 70			0 0	-	-	-	100	-	-	-	100	μA
h_{FE}		10 10		25 ^a 1 ^a		50 10	-	50 10	-	20 10	-	20 10	-	
$V_{CEO(sus)}^b$				20 ^a	0	100	-	250	-	100	-	250	-	V
V_{BE}		10		25 ^a		-	1.5	-	1.5	-	1.5	-	1.5	V
$V_{(BR)EBO}$ ($I_E = 1\text{ mA}$)				0		5	-	5	-	5	-	5	-	V
$V_{CE(sat)}$				25 ^a	5	-	2	-	2	-	2	-	2	V
$ h_{fe} $ ($f = 20\text{ MHz}$)		20		15		4 (typ.)		4 (typ.)		4 (typ.)		4 (typ.)		
f_T		20		15		80 (typ.)		80 (typ.)		80 (typ.)		80 (typ.)		MHz
I_S/b ($t = 0.05\text{ s}$)		75				130	-	130	-	130	-	130	-	mA
C_{cb} ($I_E = 0$)		20		25		-	2.25	-	2.25	-	2.25	-	2.25	pF
$R_{\theta JC}$						-	20	-	20	-	20	-	20	$^\circ\text{C/W}$
$R_{\theta JA}$						-	80	-	80	-	80	-	80	$^\circ\text{C/W}$

^a Pulsed, pulse duration = 300 μs , duty factor $\leq 2\%$.

^b CAUTION: Sustaining voltage, $V_{CEO(sus)}$, MUST NOT be measured on a curve tracer.

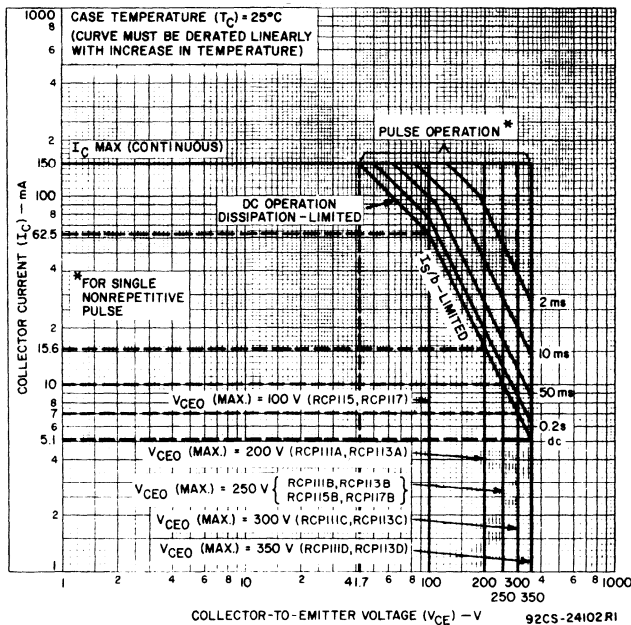


Fig. 7 - Maximum operating areas for all types.

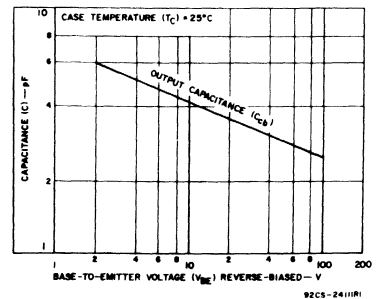


Fig. 8 - Typical junction capacitance vs. reverse-bias base-to-emitter voltage.

RCP131, RCP133, RCP135, RCP137 Series

High-Voltage, Medium-Power Silicon N-P-N Power Transistors

For TV Video Output, Horizontal Driver, and Linear-Amplifier Applications

The RCP131-, RCP133-, RCP135-, and RCP137-series devices are double-diffused, epitaxial-collector silicon n-p-n power transistors with planar junctions and field-shield construction. These transistors are designed especially for TV applications such as hori-

zontal driver, chroma output, and video output. They are also suitable for use in regulators, audio output and amplifier circuits, and electrostatic deflection in display circuits. The devices are supplied in the VERSATAB JEDEC TO-202AB, plastic package.

Features:

- Thermal-cycling ratings
- Maximum safe-area-of-operation curves
- High gain-bandwidth product: $f_T = 30$ MHz min.

MAXIMUM RATINGS, Absolute-Maximum Values:

	RCP131A RCP133A	RCP131B RCP133B	RCP131C RCP133C	RCP131D RCP133D	RCP135 RCP137	RCP135B RCP137B
$V_{CE0(sus)}$	200	250	300	350	100	250
V_{EBO}	7	7	7	7	5	5
I_C	1	1	1	1	1	1
I_B	0.5	0.5	0.5	0.5	0.5	0.5
P_T :						
$T_C \leq 25^\circ C$	10	10	10	10	10	10
$T_A \leq 25^\circ C$	1.75	1.75	1.75	1.75	1.75	1.75
For pulse operation	See Fig. 1					
T_{stg}, T_J	-65 to 150			$^\circ C$		
T_L :						
During soldering at distance $\geq 1/16$ in. (1.39 mm) from case for 10 s max.	230			$^\circ C$		

TERMINAL DESIGNATIONS

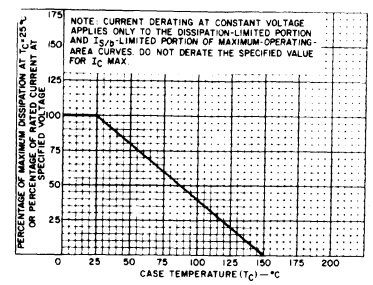
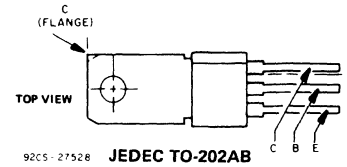


Fig. 2—Dissipation derating curve at case temperature for all types.

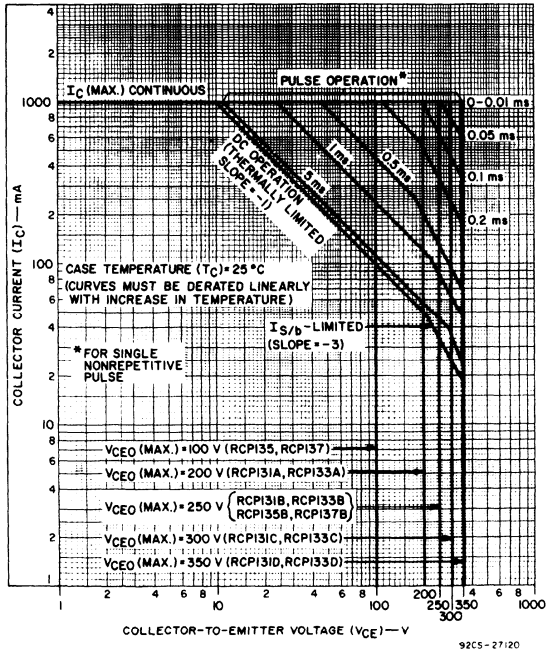


Fig. 1—Maximum operating areas for all types.

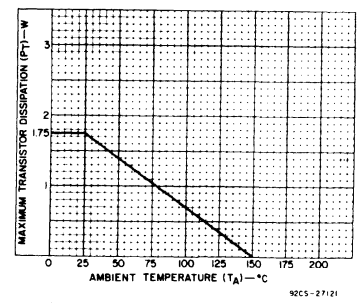


Fig. 3—Dissipation derating curve at ambient temperature for all types.

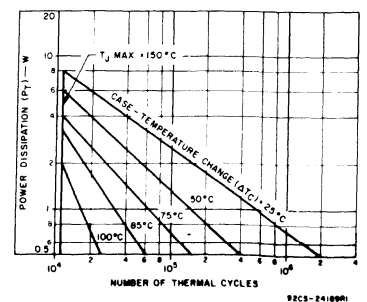


Fig. 4—Thermal-cycling rating chart for all types.

RCP131, RCP133, RCP135, RCP137 Series

ELECTRICAL CHARACTERISTICS, At Case Temperature (T_C) = 25°C

CHARACTERISTIC	TEST CONDITIONS						LIMITS				UNITS				
	VOLTAGE V dc			CURRENT mA dc			RCP131A RCP133A RCP131C RCP133C RCP135 RCP137		RCP131B RCP133B RCP131D RCP133D RCP135B RCP137B						
	V_{CB}	V_{CE}	V_{BE}	I_C	I_B	Min.	Max.	Min.	Max.						
I_{CBO} ($I_E = 0$) RCP131A, RCP133A RCP131B, RCP133B RCP131C, RCP133C RCP131D, RCP133D RCP135, RCP137 RCP135B, RCP137B	200 250 300 350 100 250					—	5	—	—	—	5	—	—	—	μA
I_{CEO} RCP131A, RCP133A RCP131B, RCP133B RCP131C, RCP133C RCP131D, RCP133D RCP135, RCP137 RCP135B, RCP137B		150 175 200 250 50 125			0 0 0 0 0 0	—	10	—	—	—	10	—	—	—	μA
I_{EBO} (RCP131, RCP133-series only)			-6	0		—	10	—	—	—	10	—	—	—	μA
h_{FE} RCP131-series RCP133-series RCP135-series RCP137-series		10 10 10 10			50 ^a 50 ^a 50 ^a 50 ^a	50 30 50 20	300 150 —	50 30 —	300 150 —	—	—	—	—	—	
$V_{CE(sus)}$ RCP131A, RCP133A RCP131B, RCP133B RCP131C, RCP133C RCP131D, RCP133D RCP135, RCP137 RCP135B, RCP137B					20 ^a 20 ^a 20 ^a 20 ^a 20 ^a 20 ^a	0 0 0 0 0 0	200 ^b — 300 ^b — — —	— — — — — —	— 250 ^b — — 350 ^b —	— — — — — —	— — — — — —	— — — — — —	— — — — — —	— — — — — —	V
V_{BE} RCP131, RCP133-series RCP135, RCP137-series		10 10			50 ^a 50 ^a	— —	1 1.5	— —	— —	1 1.5	— —	— —	— —	— —	V
$V_{(BR)EBO}$ ($I_E = 1$ mA) RCP131, RCP133-series RCP135, RCP137-series					0 0	7 5	— —	7 5	— —	— —	— —	— —	— —	— —	V
$V_{CE(sat)}$ RCP131, RCP133-series RCP135, RCP137-series					50 ^a 50 ^a	— 5	— —	— —	— —	— —	— —	— —	— —	— —	V
$ h_{fe} $ (f = 3 MHz)		20			20		10	—	—	10	—	—	—	—	
f_T		20			20		30	—	—	30	—	—	—	—	MHz
$I_{S/b}$ (t = 0.4 s)							100	—	—	100	—	—	—	—	mA
C_{ob} (f = 1 MHz)					20		—	—	—	8	—	—	—	—	pF
$R_{\theta JC}$							—	—	—	12.5	—	—	—	—	°C/W
$R_{\theta JA}$							—	—	—	71.4	—	—	—	—	°C/W

^a Pulsed, pulse duration = 300 μ s, duty factor \leq 2%.

^b CAUTION: Sustaining voltage, $V_{CEO(sus)}$, MUST NOT be measured on a curve tracer.

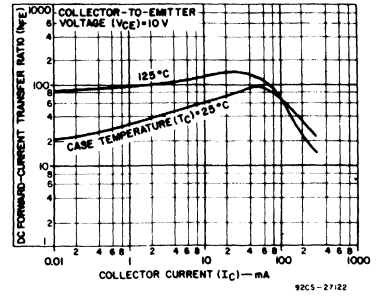


Fig. 5 - Typical dc beta characteristics for all types.

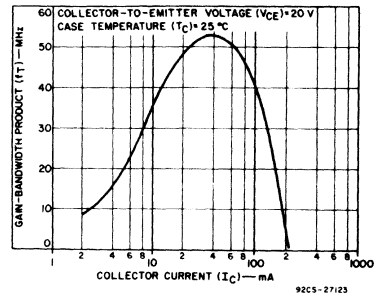


Fig. 6 - Typical gain-bandwidth product for all types.

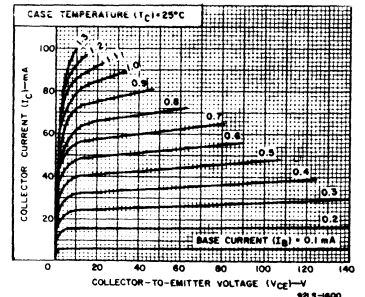


Fig. 7 - Typical output characteristics for all types.

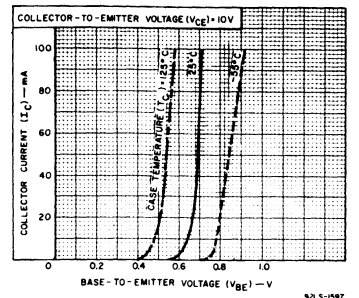


Fig. 8 - Typical transfer characteristics for all types.

RCP700, RCP702, RCP704, RCP706 Series RCP701, RCP703, RCP705, RCP707 Series

General-Purpose, Medium-Power Silicon N-P-N and P-N-P Planar Transistors

The RCA-RCP700-, RCP702-, RCP704-, and RCP706-series power transistors are double-diffused, epitaxial-planar silicon p-n-p transistors. The RCA-RCP701-, RCP703-, RCP705-, and RCP707-series power transistors are double-diffused, epitaxial-planar silicon n-p-n transistors.

All of these devices are intended for a wide variety of large-signal, general-purpose appli-

cations such as complementary vertical deflection, TV sound output, regulators, and driver and output stages of audio amplifiers.

The RCP700-, RCP702-, RCP704-, and RCP706-series types are p-n-p complements of the n-p-n devices in the RCP701, RCP703, RCP705, and RCP707 series.

These are supplied in the JEDEC TO-202AB molded plastic package.

MAXIMUM RATINGS, Absolute-Maximum Values:

	RCP700D	RCP700C	RCP700B	RCP700A	RCP704B	RCP704	RCP702D	RCP702C	RCP702B	RCP702A	RCP706B	RCP706	RCP701D	RCP701C	RCP701B	RCP701A	RCP705B	RCP705	RCP703D	RCP703C	RCP703B	RCP703A	RCP707B	RCP707	
V _{CB0}	125	105	85	55	85	45																			
V _{CEO(sus)}	100	80	60	40	60	30																			
V _{EBO}				5																					
I _C				2																					
I _B				1																					
P _T :																									
T _C ≤ 25°C				10																					
T _C > 25°C				Derate linearly 0.08 W/°C																					
T _A ≤ 25°C				1.75																					
T _A > 25°C				Derate linearly 0.014 W/°C																					
T _{stg} , T _J				-65 to 150																					
T _L																									
At distance 1/8 in. (3.17 mm) from case for 10 s max.				230																					

♦ For p-n-p devices, voltage and current values are negative.

**ELECTRICAL CHARACTERISTICS, At Case Temperature (T_C) = 25°C
RCP700 and RCP702 Series, P-N-P Types**

CHARACTERISTIC SYMBOL	TEST CONDITIONS				LIMITS								UNITS			
	VOLTAGE V _{dc}			CURRENT A dc		RCP700A RCP702A		RCP700B RCP702B		RCP700C RCP702C		RCP700D RCP702D				
	V _{CB}	V _{CE}	V _{BE}	I _C	I _B	Min.	Max.	Min.	Max.	Min.	Max.	Min.		Max.		
I _{CB0} I _{E0}	-50 -70					-	-0.5	-	-	-	-0.5	-	-	-	-0.5	
I _{CEO}		-30 -45		0	0	-	-100	-	-	-	-100	-	-	-	-100	μA
I _{CEV}		-55 -85	1.5 1.5			-	-100	-	-	-	-100	-	-	-	-100	
I _{EBO}			5	0		-	-100	-	-	-	-100	-	-	-	-100	
h _{FE} RCP700 series RCP702 series Both series		-4		-0.5 ^a -0.5 ^a -1 ^a		50 30 10	250 150 10	50 30 10	250 150 10	50 30 10	250 150 10	50 30 10	250 150 10			
V _{CEO(sus)} ^b				-0.1 ^a	0	-40	-	-60	-	-80	-	-100	-	-	-	V
V _{BE(sat)}				-0.5 ^a	-0.05	-	-1.2	-	-1.2	-	-1.2	-	-1.2	-	-1.2	V
V _{BE}		-4		-0.5 ^a		-	-1.1	-	-1.1	-	-1.1	-	-1.1	-	-1.1	V
V _{CE(sat)}				-0.5 ^a	-0.05	-	-0.8	-	-0.8	-	-0.8	-	-0.8	-	-0.8	V
h _{FE} f = 10 MHz		-4		-0.05		5	-	5	-	5	-	5	-			
f _T		-4		-0.05		50	-	50	-	50	-	50	-		MHz	
I _{S/b} With base forward biased		-35 -50				-285	-	-	-	-150	-	-150	-		mA	
C _{obo} f = 1 MHz		-10				20	40	20	40	20	40	20	40		pF	
t _{ON}	(V _{CC}) -30			0.5	I _{B1} = -0.05 I _{B2} = 0.05	-	100	-	100	-	100	-	100		ns	
t _{OFF}	(V _{CC}) -30			0.5	I _{B1} = -0.05 I _{B2} = 0.05	-	1000	-	1000	-	1000	-	1000		ns	
R _{θJC} R _{θJA}						-	12.5 71.4	-	12.5 71.4	-	12.5 71.4	-	12.5 71.4		°C/W	

^a Pulsed, pulse duration = 300 μs, duty factor ≤ 2%. ^b CAUTION: Sustaining voltage, V_{CEO(sus)}, MUST NOT be measured on a curve tracer.

Features

- Maximum safe-area-of-operation curves specified for dc operation
- Planar construction for low noise and low leakage
- High gain at high current
- Fast switching time
- Thermal-cycling ratings
- Types in RCP700, RCP702, RCP704, and RCP706 series are p-n-p complements of n-p-n types in RCP701, RCP703, RCP705, and RCP707 series

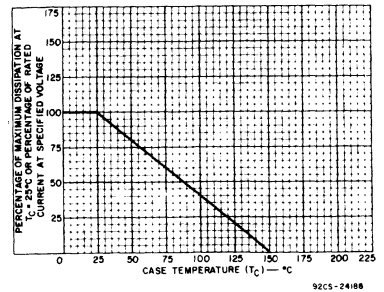
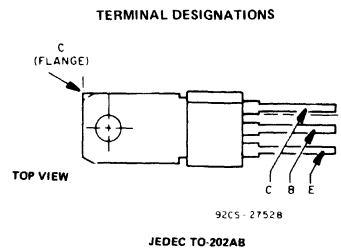


Fig. 1 - Dissipation derating curve for all types.

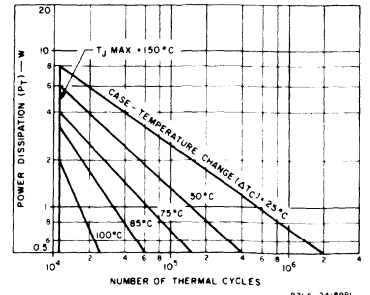


Fig. 2 - Thermal-cycling rating chart for all types.

RCP700, RCP702, RCP704, RCP706 Series RCP701, RCP703, RCP705, RCP707 Series

ELECTRICAL CHARACTERISTICS, At Case Temperature (T_C) = 25°C
RCP704, RCP705, RCP706, RCP707 Series N-P-N and P-N-P Types
RCP704 and RCP706 Series RCP705 and RCP707 Series

CHARACTERISTIC SYMBOL	TEST CONDITIONS [Ⓢ]					LIMITS								UNITS
	VOLTAGE V dc			CURRENT A dc		RCP704 RCP706		RCP704B RCP706B		RCP705 RCP707		RCP705B RCP707B		
	V _{CB}	V _{CE}	V _{BE}	I _C	I _B	Min.	Max.	Min.	Max.	Min.	Max.	Min.	Max.	
I _{CBO} I _{E=0}	-40 -70					-	-5	-	-5	-	5	-	5	
I _{CEO}				0 0		-	-1000	-	-1000	-	1000	-	1000	
I _{CEV}		-22 -45				-	-1000	-	-1000	-	1000	-	1000	
I _{EBO}			-5	0		-	-100	-	-100	-	100	-	100	
h _{FE} RCP704 RCP705 series RCP706 RCP707 series		-4 -4		-0.5 [Ⓢ] -0.5 [Ⓢ]		50 20	-	50 20	-	50 20	-	50 20	-	
V _{CEO(sus)} ^b				-0.1 [Ⓢ]	0	-30	-	-60	-	30	-	60	-	
V _{BE(sat)}				-0.5 [Ⓢ]	-0.05	-	-1.6	-	-1.6	-	1.6	-	1.6	
V _{BE}		-4		-0.5 [Ⓢ]		-	-1.5	-	-1.5	-	1.5	-	1.5	
V _{CE(sat)}				-0.5 [Ⓢ]	-0.05	-	-1.2	-	-1.2	-	1.2	-	1.2	
h _{FE} f=10 MHz		-4		-0.05		5	-	5	-	5	-	5	-	
f _T		-4		-0.05		50	-	50	-	50	-	50	-	
I _{S/b} With base forward biased		-20 -50				-500	-	-	-	500	-	120	-	
C _{obo} f=1 MHz		-10				20	40	20	40	8	25	8	25	
t _{ON}	(V _{CC}) -30			0.5	I _{B1} =-0.05 I _{B2} =0.05	-	100	-	100	-	80	-	80	
t _{OFF}	(V _{CC}) -30			0.5	I _{B1} =-0.05 I _{B2} =0.05	-	1000	-	1000	-	800	-	800	
R _{θJC} R _{θJA}						-	12.5 71.4	-	12.5 71.4	-	12.5 71.4	-	12.5 71.4	

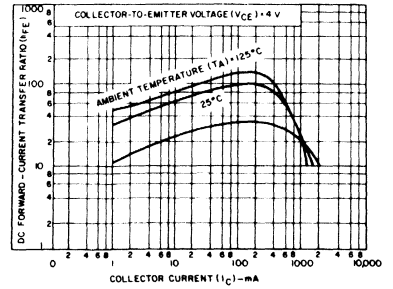


Fig. 3 - Typical static beta characteristics for RCP701, RCP703, RCP705, RCP707-series types.

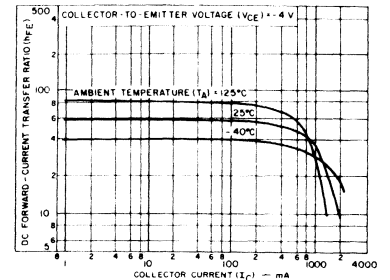


Fig. 4 - Typical static beta characteristics for RCP700, RCP702, RCP704, RCP706-series types.

ELECTRICAL CHARACTERISTICS, At Case Temperature (T_C) = 25°C
RCP701 and RCP703 Series, N-P-N Types

CHARACTERISTIC SYMBOL	TEST CONDITIONS					LIMITS								UNITS
	VOLTAGE V dc			CURRENT A dc		RCP701A RCP703A		RCP701B RCP703B		RCP701C RCP703C		RCP701D RCP703D		
	V _{CB}	V _{CE}	V _{BE}	I _C	I _B	Min.	Max.	Min.	Max.	Min.	Max.	Min.	Max.	
I _{CBO} I _{E=0}	50 70					-	0.5	-	0.5	-	0.5	-	0.5	
I _{CEO}		30 45		0 0		-	100	-	100	-	100	-	100	
I _{CEV}		55 85		-1.5 -1.5		-	100	-	100	-	100	-	100	
I _{EBO}			-5	0		-	100	-	100	-	100	-	100	
h _{FE} RCP701 series RCP703 series Both series		4 4 4		0.5 [Ⓢ] 0.5 [Ⓢ] 1 [Ⓢ]		50 30 10	250 150 10	50 30 10	250 150 10	50 30 10	250 150 10	50 30 10	250 150 10	
V _{CEO(sus)} ^b				0.1 [Ⓢ]	0	40	-	60	-	80	-	100	-	
V _{BE(sat)}				0.5 [Ⓢ]	0.05	-	1.2	-	1.2	-	1.2	-	1.2	
V _{BE}		4		0.5 [Ⓢ]		-	1.1	-	1.1	-	1.1	-	1.1	
V _{CE(sat)}				0.5 [Ⓢ]	0.05	-	0.8	-	0.8	-	0.8	-	0.8	
h _{FE} f=10 MHz		4		0.05		5	-	5	-	5	-	5	-	
f _T		4		0.05		50	-	50	-	50	-	50	-	
I _{S/b} With base forward biased		20 50				500	-	-	-	200	-	200	-	
C _{obo} f=1 MHz		10				8	20	8	20	8	20	8	20	
t _{ON}	(V _{CC}) 30			0.5	I _{B1} =0.05 I _{B2} =-0.05	-	80	-	80	-	80	-	80	
t _{OFF}	(V _{CC}) 30			0.5	I _{B1} =0.05 I _{B2} =-0.05	-	800	-	800	-	800	-	800	
R _{θJC} R _{θJA}						-	12.5 71.4	-	12.5 71.4	-	12.5 71.4	-	12.5 71.4	

[Ⓢ] Pulsed, pulse duration = 300 μs, duty factor < 2%.

[Ⓢ] For p-n-p devices, voltage and current values are negative.

^b CAUTION: Sustaining voltage, V_{CEO(sus)}, MUST NOT be measured on a curve tracer.

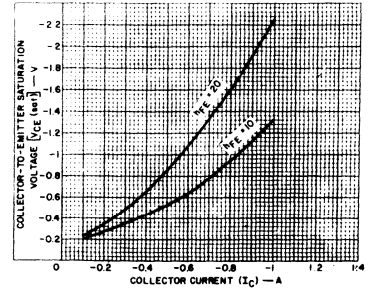


Fig. 5 - Typical saturation-voltage characteristics for RCP700, RCP702, RCP704, RCP706-series types.

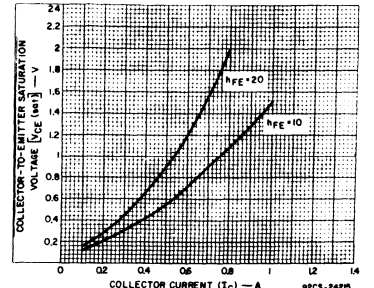


Fig. 6 - Typical saturation-voltage characteristics for RCP701, RCP703, RCP705, RCP707-series types.

RCP700, RCP702, RCP704, RCP706 Series
RCP701, RCP703, RCP705, RCP707 Series

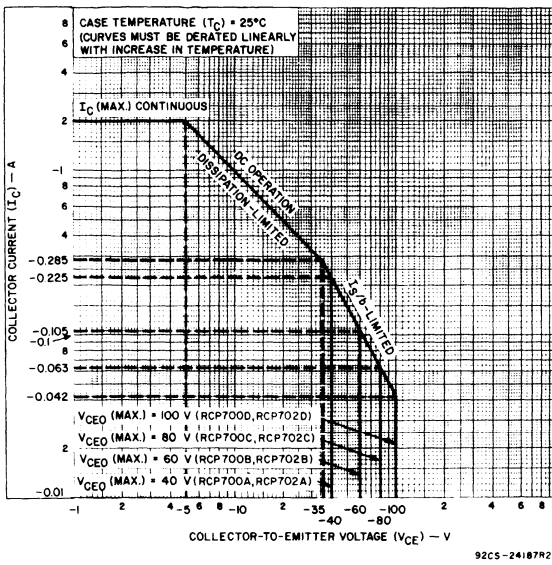


Fig. 7 - Maximum operating areas for RCP700-series and RCP702-series types.

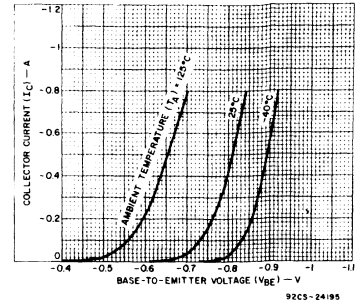


Fig. 8 - Typical transfer characteristics for RCP700, RCP702, RCP704, RCP706-series types.

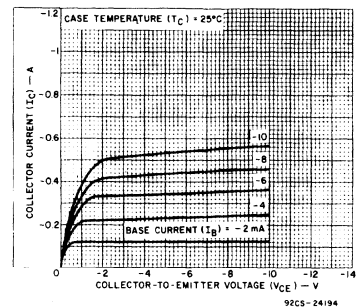


Fig. 9 - Typical output characteristics for RCP700, RCP702, RCP704, RCP706-series types.

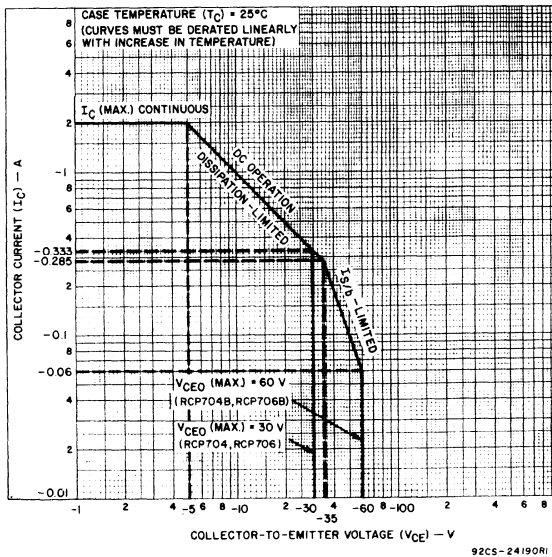


Fig. 10 - Maximum operating areas for RCP704-series and RCP706-series types.

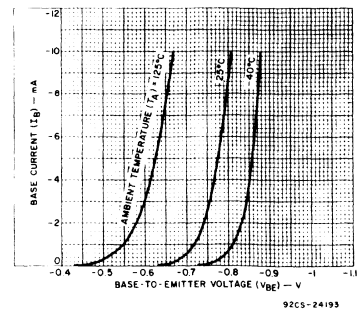
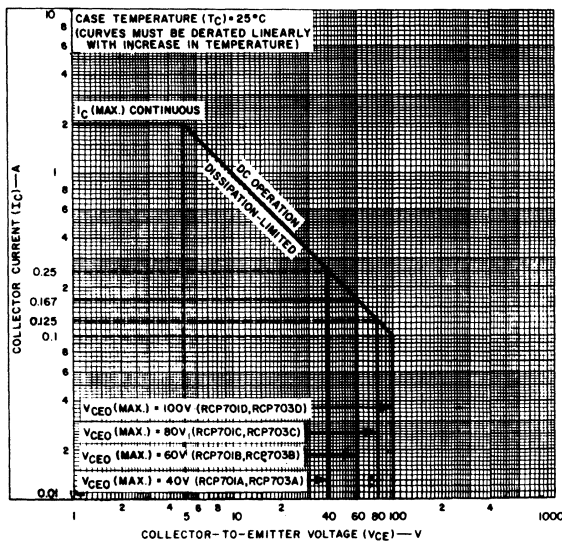


Fig. 11 - Typical input characteristics for RCP700, RCP702, RCP704, RCP706-series types.

RCP700, RCP702, RCP704, RCP706 Series RCP701, RCP703, RCP705, RCP707 Series



92CS-2421BR2

Fig. 12 - Maximum operating areas for RCP701-series and RCP703-series types.

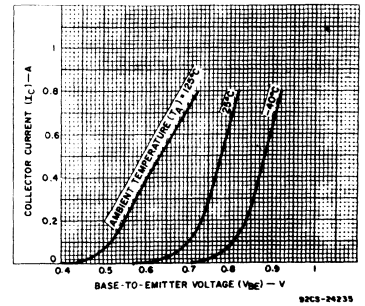
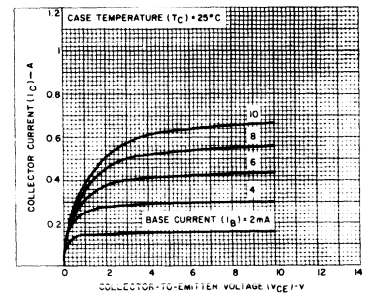
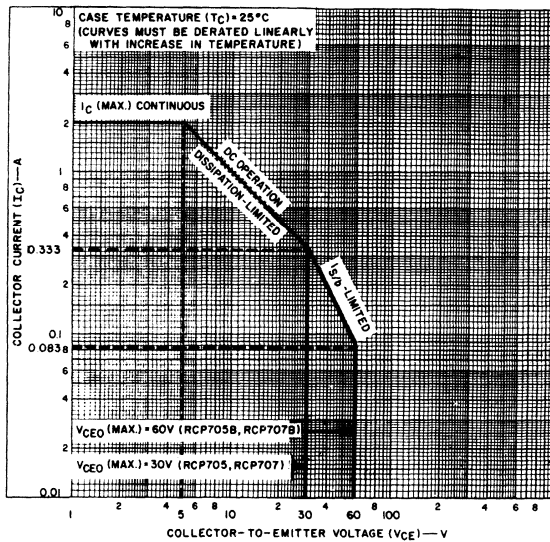


Fig. 13 - Typical transfer characteristics for RCP701, RCP703, RCP705, RCP707-series types.



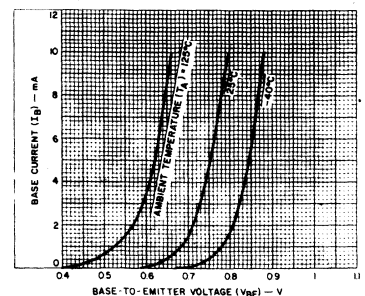
92CS-2421R6

Fig. 14 - Typical output characteristics for RCP701, RCP703, RCP705, RCP707-series types.



92CS-2421R9

Fig. 15 - Maximum operating areas for RCP705-series and RCP707-series types.



92CS-2424

Fig. 16 - Typical input characteristics for RCP701, RCP703, RCP705, RCP707-series types.

RCS683, RCS683A, RCS683B

4-Ampere Monolithic N-P-N Darlington Power Transistors

40-60-80 Volts, 10 Watts
Gain of 1000 at 2 A

Features:

- Operates from 1C without predriver
- Low leakage at high temperature
- High reverse second-breakdown capability

Applications:

- Power switching
- Audio amplifiers
- Hammer drivers
- Series and shunt regulators

The RCS683, RCS683A, and RCS683B* are monolithic n-p-n silicon Darlington transistors designed for low- and medium-frequency power applications. The double epitaxial construction of these devices provides good forward and reverse second-breakdown capability; their high gain makes it possible for them to be driven directly from integrated circuits; and their small package (TO-39) permits compact design.

* Formerly RCA Dev. Nos. TA8698C, TA8698B, and TA8698A, respectively.

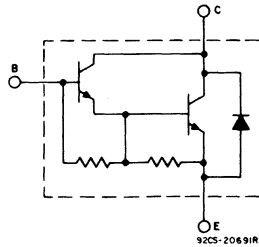
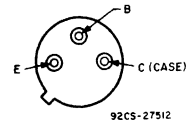


Fig. 1 - Schematic diagram for all types.

TERMINAL DESIGNATIONS



JEDEC TO-39

MAXIMUM RATINGS, Absolute-Maximum Values:

	RCS683	RCS683A	RCS683B	
V _{CB0}	40	60	80	V
V _{CER(sus)}				
R _{BE} = 100 Ω	40	60	80	V
V _{CEO(sus)}	40	60	80	V
V _{CEX}				
V _{BE} = -1.5 V, R _{BB} = 100 Ω	40	60	80	V
V _{EBO}		5		V
I _C		4		A
I _{CM}		6		A
I _B		0.1		A
P _T				
T _C < 25°C		10		W
T _C > 25°C		derate linearly at 0.08		W/°C
T _{stg}		-65 to +200		°C
T _J		-65 to +150		°C
T _L				
At distances > 1/32 in. (0.8 mm) from seating plane for 10 s max.		235		°C

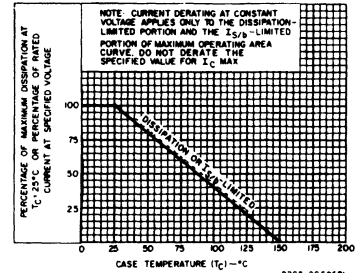


Fig. 2 - Derating curve.

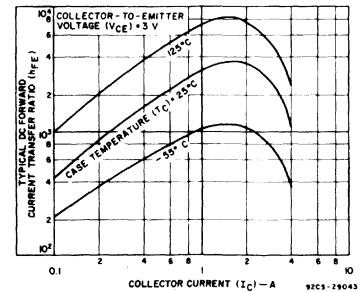


Fig. 4 - Typical DC beta characteristics.

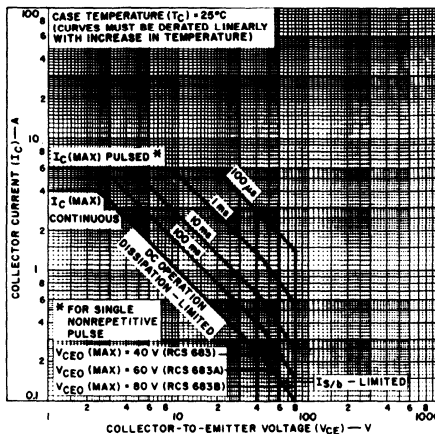


Fig. 3 - Maximum operating area.

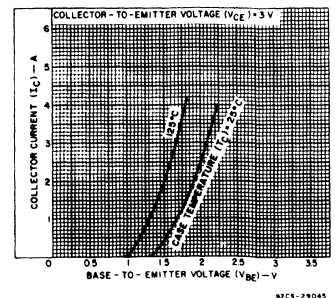


Fig. 5 - Typical transfer characteristics.

RCS683, RCS683A, RCS683B

ELECTRICAL CHARACTERISTICS, At Case Temperature (T_C) = 25°C
 Unless Otherwise Specified

CHARACTERISTIC SYMBOL	TEST CONDITIONS				LIMITS						UNITS
	VOLTAGE		CURRENT		RCS683		RCS683A		RCS683B		
	V dc	A dc	V dc	A dc	MIN.	MAX.	MIN.	MAX.	MIN.	MAX.	
I_{CEO}	40			0	-	1	-	-	-	-	
	60			0	-	-	-	1	-	-	
	80			0	-	-	-	-	-	1	
I_{CEV}	40	-1.5			-	0.15	-	-	-	-	mA
	60	-1.5			-	-	-	0.15	-	-	
	80	-1.5			-	-	-	-	-	0.15	
$T_C = 125^\circ\text{C}$	40	-1.5			-	1.5	-	-	-	-	
	60	-1.5			-	-	-	1.5	-	-	
	80	-1.5			-	-	-	-	-	1.5	
I_{EBO}		-5	0		-	2	-	2	-	2	
$V_{CEO(sus)}$			0.1 ^a	0	40	-	60	-	80	-	V
h_{FE}	3		2 ^a		1000	-	1000	-	1000	-	
	3		4 ^a		200	-	200	-	200	-	
V_{BE}	3		2 ^a		-	2.4	-	2.4	-	2.4	V
	3		4 ^a		-	4	-	4	-	4	
$V_{CE(sat)}$			2 ^a	0.004	-	1.6	-	1.6	-	1.6	V
			4 ^a	0.04	-	2.8	-	2.8	-	2.8	
V_F			-4		-	3	-	3	-	3	
$ h_{fe} $ f = 1 MHz	5		1		20	-	20	-	20	-	
C_{obo}	$V_{CB} = 10$			$I_E = 0$	-	60	-	60	-	60	pF
E_S/b^b L = 12 mH, $R_{BE} = 100 \Omega$		-1.5			30	-	30	-	30	-	mJ
I_S/b $t = 0.5$ s non rep.	35				0.28	-	-	-	-	-	A
	55				-	-	0.17	-	-	-	
	75				-	-	-	-	0.11	-	
$R_{\theta JC}$					-	12.5	-	12.5	-	12.5	°C/W

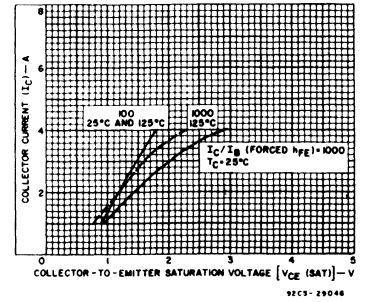


Fig. 6 - Typical saturation characteristics.

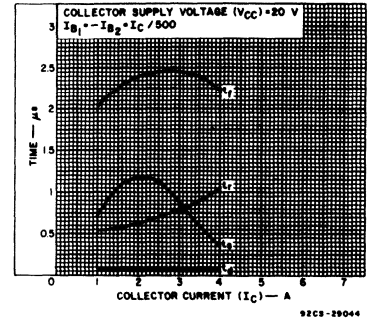


Fig. 7 - Typical saturated switching time characteristics.

^a Pulsed: Pulse duration = 300 μ s, duty factor = 2%.

^b E_S/b is defined as the energy at which second breakdown occurs under specified reverse bias conditions.

$E_S/b = 1/2LI^2$ where L is a series load or leakage inductance, and I is the peak collector current.

TIP29, RCA29, RCS29 Series

Epitaxial-Base, Silicon N-P-N VERSAWATT Transistors

For Power-Amplifier and High-Speed-Switching Applications

The RCA-TIP29, RCA29 and RCS29-series are epitaxial-base, silicon n-p-n transistors intended for a wide variety of switching and amplifier applications, such as series and shunt regulators and driver and output stages of high-fidelity amplifiers. These power transistors are designed for complementary use with devices in the TIP30, RCA30 and RCS30-series.

They differ from each other in voltage ratings.

The TIP29 and RCA29-series are supplied in the JEDEC TO-220AB straight-lead version of the VERSAWATT package, and can be provided in formed-lead configurations upon request. The RCA29-series are supplied in the JEDEC TO-213MA hermetic package.

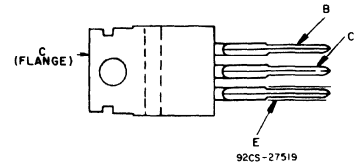
Features:

- 30 W at 25°C case temperature
- 3 A rated collector current
- Min. f_T of 3 MHz at 10 V, 200 mA
- Designed for complementary use with TIP30, RCA30 and RCS30-series p-n-p types

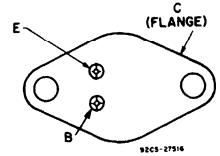
MAXIMUM RATINGS, Absolute-Maximum Values:

	TIP29 RCA29 RCS29	TIP29A RCA29A RCS29A	TIP29B RCA29B RCS29B	TIP29C RCA29C RCS29C	
V_{CBO}	40	60	80	100	V
V_{CEO}	40	60	80	100	V
V_{EBO}	5	5	5	5	V
I_C	5	5	5	5	A
I_B	1	1	1	1	A
P_T					
At $T_C \leq 25^\circ C$	30	30	30	30	W
At $T_A \leq 25^\circ C$	2	2	2	2	W
At $T_C > 25^\circ C$ TIP29 and RCA29-series	Derate linearly			0.24	W/°C
RCS29-series	Derate linearly			0.17	W/°C
T_{stg}, T_J TIP29 and RCA29-series	-65 to 150				°C
RCS29-series	-65 to 200				°C
T_L (During soldering):					
At distance 1/8 in. (3.17 mm) from case for 10s max. TIP29 and RCA29-series				235	°C
At a distance $\geq 1/32$ inch (0.8 mm) from seating plane for 10s max. (RCS29-series)				235	°C

TERMINAL CONNECTIONS



BOTTOM VIEW
JEDEC TO-220AB
TIP29 and RCA29-series



JEDEC TO-213MA
RCA29-series

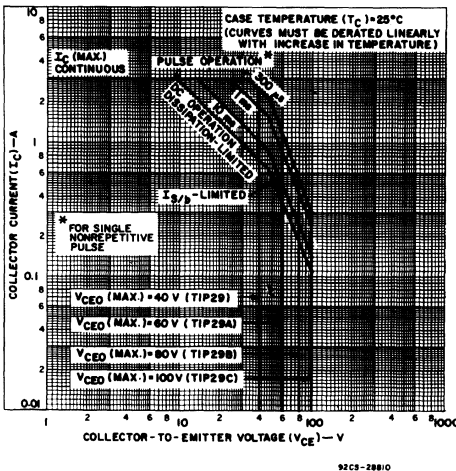


Fig. 1 — Maximum operating areas for TIP29-series.

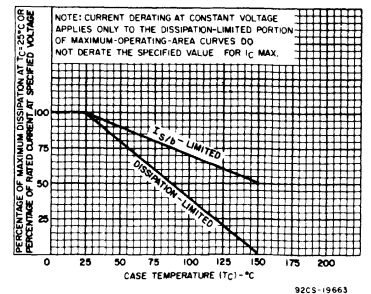


Fig. 2 — Derating curve for TIP29-series and RCA29-series.

TIP29, RCA29, RCS29 Series

ELECTRICAL CHARACTERISTICS, At Case Temperature (T_C) = 25°C unless otherwise specified

CHARACTERISTIC	TEST COND.		LIMITS								Units		
	VOLTAGE V dc	CURRENT A dc	TIP29 RCA29 RCS29		TIP29A RCA29A RCS29A		TIP29B RCA29B RCS29B		TIP29C RCA29C RCS29C				
	VCE	IC	Min.	Max.	Min.	Max.	Min.	Max.	Min.	Max.			
I_{CE0} $I_B=0$	30 60		-	0.3	-	0.3	-	-	-	0.3	-	0.3	mA
I_{CES} $V_{EB}=0$	40 60 80 100		-	0.2	-	-	-	-	-	-	-	-	mA
I_{EBO} $V_{BE}=-5V$		0	-	1	-	1	-	1	-	-	-	1	mA
$V_{CE0(sus)}$ $I_B=0$		0.03 ^a	40 ^b	-	60 ^b	-	80 ^b	-	100 ^b	-	-	-	V
h_{FE}	4 4	0.2 ^a 1 ^a	40 15	- 150	40 15	- 150	40 15	- 150	40 15	- 150	-	-	
V_{BE}	4	1 ^a	-	1.3	-	1.3	-	1.3	-	1.3	-	-	V
$V_{CE(sat)}$ $I_B=0.125A$		1 ^a	-	0.7	-	0.7	-	0.7	-	0.7	-	-	V
h_{fe} $f=1\text{ kHz}$	10	0.2	20	-	20	-	20	-	20	-	-	-	
$ h_{fe} $ $f=1\text{ MHz}$	10	0.2	3	-	3	-	3	-	3	-	-	-	
t_{ON} (t_d+t_r) $V_{CC}=30V$ $R_L=30\Omega$ $I_{B1}=I_{B2}=0.1A$		1	0.4 (typ.)		0.4 (typ.)		0.4 (typ.)		0.4 (typ.)				μs
t_{OFF} (t_s+t_f) $V_{CC}=30V$ $R_L=30\Omega$ $I_{B1}=-I_{B2}=0.1A$		1	1.2 (typ.)		1.2 (typ.)		1.2 (typ.)		1.2 (typ.)				μs
$R_{\theta JC}$	TIP29 and RCA29-series		-	4.17	-	4.17	-	4.17	-	4.17			°C/W
	RCS29-series		-	5.83	-	5.83	-	5.83	-	5.83			
$R_{\theta JA}$	TIP29 and RCA29-series		-	62.5	-	62.5	-	62.5	-	62.5			°C/W
	RCS29-series		-	60	-	60	-	60	-	60			

^a Pulsed, pulse duration = 300 μs , duty factor $\leq 2\%$.
^b CAUTION: Sustaining voltage, $V_{CE0(sus)}$, MUST NOT be measured on a curve tracer.

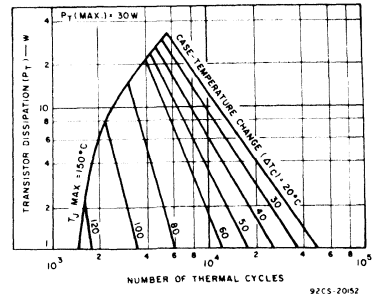


Fig. 3 - Thermal-cycling ratings for TIP29 and RCA29-series.

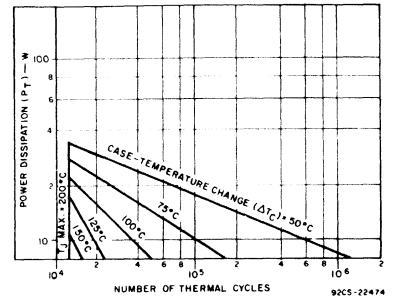


Fig. 4 - Thermal-cycling rating chart for RCS29-series.

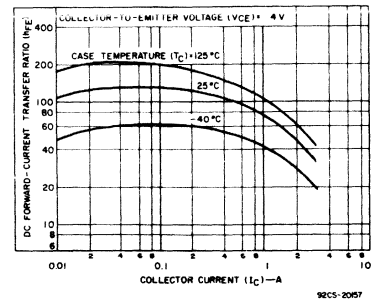


Fig. 5 - Typical dc beta characteristics for TIP29, TIP29A, TIP29B, RCA29, RCA29A, RCA29B; RCS29, RCS29A and RCS29B.

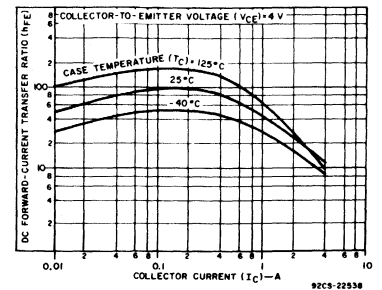


Fig. 6 - Typical dc beta characteristics for TIP29C, RCA29C and RCS29C.

TIP30, RCA30, RCS30 Series

Epitaxial-Base, Silicon P-N-P VERSAWATT Transistors

For Power-Amplifier and High-Speed-Switching Applications

The RCA-TIP30, RCA30 and RCS30-series are epitaxial-base, silicon p-n-p transistors intended for a wide variety of switching and amplifier applications, such as series and shunt regulators and driver and output stages of high-fidelity amplifiers. These power transistors are designed for complementary use with devices in the TIP29, RCA29 and RCS29-series.

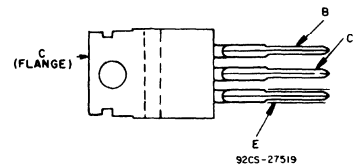
They differ from each other in voltage ratings.

The TIP30 and RCA30-series are supplied in the JEDEC TO-220AB straight-lead version of the VERSAWATT package, and can be provided in formed-lead configurations upon request. The RCS30-series are supplied in the JEDEC TO-213MA hermetic package.

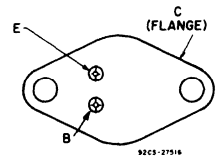
Features:

- 30 W at 25°C case temperature
- 3 A rated collector current
- Min. f_T of 3 MHz at -10 V, -200 mA
- Designed for complementary use with TIP29, RCA29 and RCS29-series n-p-n types

TERMINAL DESIGNATIONS



BOTTOM VIEW
JEDEC TO-220AB
TIP30 and RCA30-series



JEDEC TO-213MA
RCS30-series

MAXIMUM RATINGS, Absolute-Maximum Values:

	TIP RCA30	TIP30A RCS30A	TIP30B RCS30B	TIP30C RCA30C	
V_{CBO}	-40	-60	-80	-100	V
V_{CEO}	-40	-60	-80	-100	V
V_{EBO}	-5	-5	-5	-5	V
I_C	-5	-5	-5	-5	A
I_B	-1	-1	-1	-1	A
P_T :					
At $T_C \leq 25^\circ C$	30	30	30	30	W
At $T_A \leq 25^\circ C$	2	2	2	2	W
At $T_C > 25^\circ C$ (TIP30 and RCA30-series) Derate linearly			0.24		W/°C
RCS30-series Derate linearly			0.17		W/°C
T_{stg}, T_J TIP30 and RCA30-series			-65 to 150		°C
RCS30-series			-65 to 200		°C
T_L (During soldering):					
At distance 1/8 in. (3.17 mm) from case for 10s max. (TIP30 and RCA30-series)			235		°C
At a distance $\geq 1/32$ inch (0.8 mm) from seating plane for 10s max. (RCS30-series)			235		°C

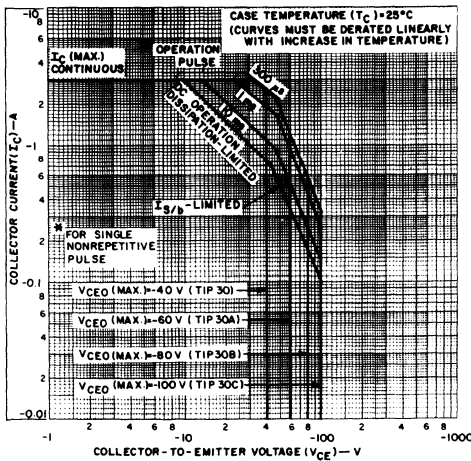


Fig. 1 - Maximum operating areas for TIP30-series.

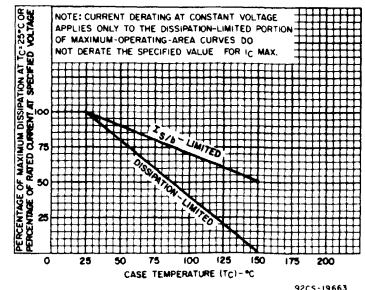


Fig. 2 - Derating curve to TIP30 and RCA30-series.

TIP30, RCA30, RCS30 Series

ELECTRICAL CHARACTERISTICS, At Case Temperature (T_C) = 25°C unless otherwise specified

CHARACTERISTIC	TEST COND.		LIMITS								Units		
	VOLT-AGE V dc	CUR. RENT A dc	TIP30 RCA30 RCS30		TIP30A RCA30A RCS30A		TIP30B RCA30B RCS30B		TIP30C RCA30C RCS30C				
	VCE	IC	Min.	Max.	Min.	Max.	Min.	Max.	Min.	Max.			
I_{CE0} $I_B=0$	-30 -60		-	-0.3	-	-0.3	-	-	-	-0.3	-	-0.3	mA
I_{CES} $V_{EB}=0$	-40 -60 -80 -100		-	-0.2	-	-	-	-	-	-	-	-0.2	mA
I_{EBO} $V_{BE}=5V$		0	-	-1	-	-1	-	-1	-	-1	-	-1	mA
$V_{CE0(sus)}$ $I_B=0$		-0.03 ^a	-40 ^b	-	-60 ^b	-	-80 ^b	-	-100 ^b	-	-	-	V
h_{FE}	-4 -4	-0.2 ^a -1 ^a	40 15	-	40 15	-	40 15	-	40 15	-	40 15	-	
V_{BE}	-4	-1 ^a	-	-1.3	-	-1.3	-	-1.3	-	-1.3	-	-1.3	V
$V_{CE(sat)}$ $I_B=-0.125A$		-1 ^a	-	-0.7	-	-0.7	-	-0.7	-	-0.7	-	-0.7	V
h_{fe} f=1 kHz	-10	-0.2	20	-	20	-	20	-	20	-	20	-	
$ h_{fe} $ f=1 MHz	-10	-0.2	3	-	3	-	3	-	3	-	3	-	
t_{ON} (t_d+t_r) VCC=-30V RL=30Ω IB1=-IB2 =-0.1A		-1	0.2 (typ.)	-	0.2 (typ.)	-	0.2 (typ.)	-	0.2 (typ.)	-	0.2 (typ.)	-	μs
t_{OFF} (t_s+t_f) VCC=-30V RL=30Ω IB1=-IB2 =-0.1A		-1	1 (typ.)	-	1 (typ.)	-	1 (typ.)	-	1 (typ.)	-	1 (typ.)	-	μs
$R_{\theta JC}$	TIP31 and RCA31-series		-	4.17	-	4.17	-	4.17	-	4.17	-	4.17	°C/W
	RCS31-series		-	5.83	-	5.83	-	5.83	-	5.83	-	5.83	
$R_{\theta JA}$	TIP31 and RCA31-series		-	62.5	-	62.5	-	62.5	-	62.5	-	62.5	°C/W
	RCS31-series		-	60	-	60	-	60	-	60	-	60	

^a Pulsed, pulse duration = 300 μs, duty factor ≤ 2%.
^b CAUTION: Sustaining voltage, $V_{CE0(sus)}$, MUST NOT be measured on a curve tracer.

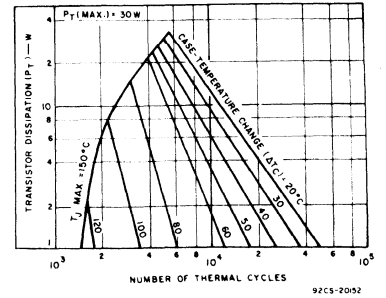


Fig. 3 - Thermal-cycling ratings for TIP30 and RCA30-series.

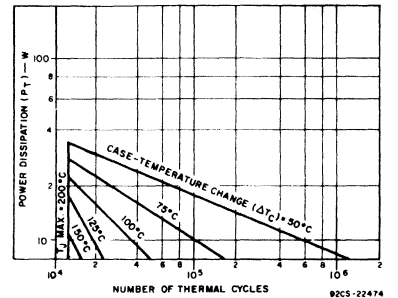


Fig. 4 - Thermal-cycling rating chart for RCS30-series.

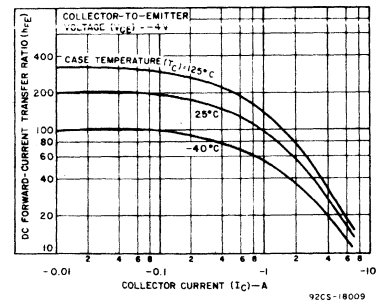


Fig. 5 - Typical dc beta characteristics for TIP30, TIP30A, TIP30B, RCA30, RCA30A, RCA30B, RCS30A and RCS30B.

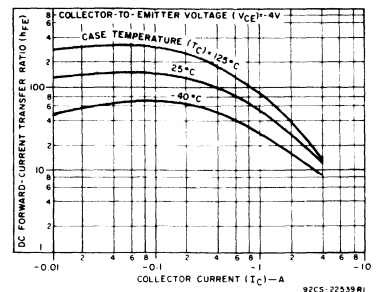


Fig. 6 - Typical dc beta characteristics for TIP30C, RCA30C, and RCS30C.

TIP31, RCA31, RCS31 Series

Epitaxial-Base, Silicon N-P-N VERSAWATT Transistors

For Power-Amplifier and High-Speed-Switching Applications

The RCA-TIP31, RCA31 and RCS31-series are epitaxial-base, silicon n-p-n transistors intended for a wide variety of switching and amplifier applications, such as series and shunt regulators and driver and output stages of high-fidelity amplifiers. These power transistors are designed for complementary use with devices in the TIP32, RCA32 and RCS32-series.

They differ from each other in voltage ratings.

The TIP31 and RCS31-series are supplied in the JEDEC TO-220AB straight-lead version of the VERSAWATT package, and can be provided in formed-lead configurations upon request. The RCS31-series are supplied in the JEDEC TO-213MA hermetic package.

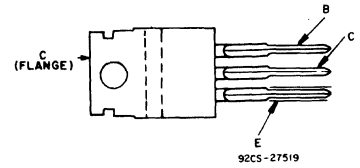
Features:

- 40 W at 25°C case temperature
- 5 A rated collector current
- Min. f_T of 3 MHz at 10 V, 500 mA
- Designed for complementary use with TIP32, RCA32 and RCS32-series p-n-p types

MAXIMUM RATINGS, Absolute-Maximum Values:

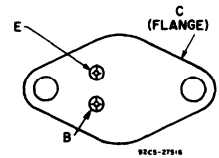
	TIP31 RCA31 RCS31	TIP31A RCA31A RCS31A	TIP31B RCA31B RCS31B	TIP31C RCA31C RCS31C	
V_{CBO}	40	60	80	100	V
V_{CEO}	40	60	80	100	V
V_{EBO}	5	5	5	5	V
I_C	5	5	5	5	A
I_B	1	1	1	1	A
P_T :					
At $T_C \leq 25^\circ C$	40	40	40	40	W
At $T_A \leq 25^\circ C$	2	2	2	2	W
At $T_C > 25^\circ C$ (TIP31 and RCA31-series) Derate linearly		0.32			W/ $^\circ C$
RCS31-series Derate linearly		0.23			W/ $^\circ C$
T_{stg}, T_J TIP31 and RCA31-series		-65 to 150			$^\circ C$
RCS31-series		-65 to 200			$^\circ C$
T_L (During soldering):					
At distance 1/8 in. (3.17 mm) from case for 10s max. (TIP31 and RCA31-series)		235			$^\circ C$
At a distance $\geq 1/32$ inch (0.8 mm) from seating plane for 10s max. (RCS31-series)		235			$^\circ C$

TERMINAL DESIGNATIONS



BOTTOM VIEW

JEDEC TO-220AB
TIP31 and RCA31-series



JEDEC TO-213MA
RCS31-series

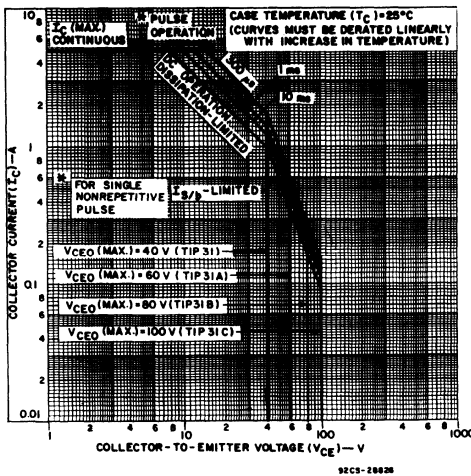


Fig. 1 - Maximum operating areas for TIP31-series.

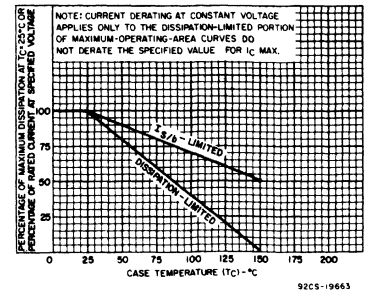


Fig. 2 - Derating curve for TIP31 and RCA31-series.

TIP31, RCA31, RCS31 Series

ELECTRICAL CHARACTERISTICS, At Case Temperature (T_C) = 25°C unless otherwise specified

CHARACTERISTIC	TEST COND.		LIMITS								Units	
	VOLTAGE V dc	CUR. RENT A dc	TIP31 RCA31		TIP31A RCA31A RCS31A		TIP31B RCA31B RCS31B		TIP31C RCA31C RCS31C			
			Min.	Max.	Min.	Max.	Min.	Max.	Min.	Max.		
I_{CEO} $I_B=0$	30 60		-	0.3	-	0.3	-	-	-	-	0.3	mA
I_{CES} $V_{EB}=0$	40 60 80 100		-	0.2	-	0.2	-	-	0.2	-	0.2	mA
I_{EBO} $V_{BE}=-5V$		0	-	1	-	1	-	1	-	1	mA	
$V_{CEO(sus)}$ $I_B=0$		0.03 ^a	40 ^b	-	60 ^b	-	80 ^b	-	100 ^b	-		V
h_{FE}	4 4	1 ^a 3 ^a	25 10	- 50	25 10	- 50	25 10	- 50	25 10	- 50		
V_{BE}	4	3 ^a	-	1.8	-	1.8	-	1.8	-	1.8	V	
$V_{CE(sat)}$ $I_B=0.375A$		3 ^a	-	1.2	-	1.2	-	1.2	-	1.2	V	
h_{fe} $f=1\text{ kHz}$	10	0.5	20	-	20	-	20	-	20	-		
$ h_{fe} $ $f=1\text{ MHz}$	10	0.5	3	-	3	-	3	-	3	-		
t_{ON} (t_d+t_r) $V_{CC}=30V$ $R_L=30\Omega$ $I_{B1}=I_{B2}=0.1A$		1	0.4 (typ.)		0.4 (typ.)		0.4 (typ.)		0.4 (typ.)		μs	
t_{OFF} (t_s+t_f) $V_{CC}=30V$ $R_L=30\Omega$ $I_{B1}=-I_{B2}=0.1A$		1	1.2 (typ.)		1.2 (typ.)		1.2 (typ.)		1.2 (typ.)		μs	
$R_{\theta JC}$	TIP31 and RCA31-series		-	3.125	-	3.125	-	3.125	-	3.125		°C/W
	RCS31-series		-	4.3	-	4.3	-	4.3	-	4.3		
$R_{\theta JA}$	TIP31 and RCA31-series		-	62.5	-	62.5	-	62.5	-	62.5		°C/W
	RCS31-series		-	60	-	60	-	60	-	60		

^a Pulsed, pulse duration = 300 μs , duty factor $\leq 2\%$.

^b CAUTION: Sustaining voltage, $V_{CEO(sus)}$, MUST NOT be measured on a curve tracer.

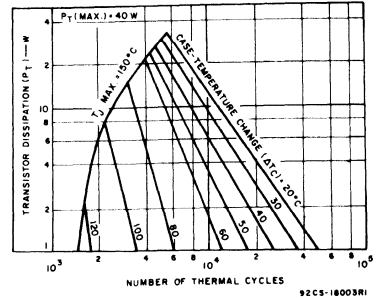


Fig. 3 - Thermal-cycling ratings for TIP31 and RCA31-series.

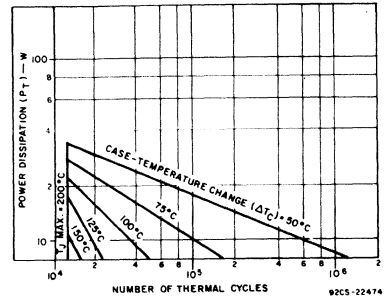


Fig. 4 - Thermal-cycling rating chart for RCS31-series

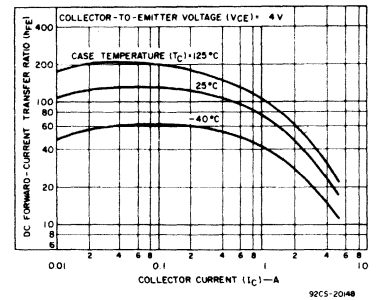


Fig. 5 - Typical dc beta characteristics for TIP31, TIP31A, TIP31B, RCA31, RCA31A, RCA31B, RCS31, RCS31A, and RCS31B.

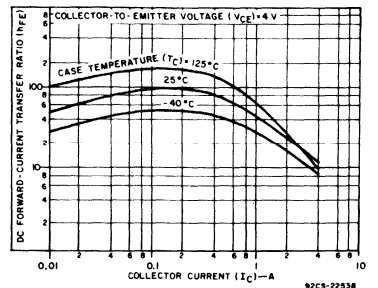


Fig. 6 - Typical dc beta characteristics for TIP31C, RCA31C and RCS31C.

TIP32, RCA32, RCS32 Series

Epitaxial-Base, Silicon P-N-P VERSAWATT Transistors

For Power-Amplifier and High-Speed-Switching Applications

The RCA-TIP32, RCA32 and RCS32-series are epitaxial-base, silicon p-n-p transistors intended for a wide variety of switching and amplifier applications, such as series and shunt regulators and driver and output stages of high-fidelity amplifiers. These power transistors are designed for complementary use with devices in the TIP31, RCA31 and RCS31-series.

They differ from each other in voltage ratings.

The TIP32 and RCS32-series are supplied in the JEDEC TO-220AB straight-lead version of the VERSAWATT package, and can be provided in formed-lead configurations upon request. The RCS32-series are supplied in the JEDEC TO-213MA hermetic package.

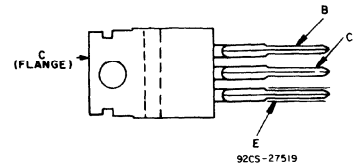
Features:

- 40 W at 25°C case temperature
- 5 A rated collector current
- Min. f_T of 3 MHz at -10 V, -500 mA
- Designed for complementary use with TIP31, RCA31 and RCS31-series n-p-n types

MAXIMUM RATINGS, Absolute-Maximum Values:

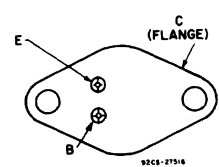
	TIP32 RCA32 RCS32	TIP32A RCA32A RCS32A	TIP32B RCA32B RCS32B	TIP32C RCA32C RCS32C	
V_{CBO}	-40	-60	-80	-100	V
V_{CEO}	-40	-60	-80	-100	V
V_{EBO}	-5	-5	-5	-5	V
I_C	-5	-5	-5	-5	A
I_B	-1	-1	-1	-1	A
P_T :					
At $T_C \leq 25^\circ C$	40	40	40	40	W
At $T_A \leq 25^\circ C$	2	2	2	2	W
At $T_C > 25^\circ C$ (TIP32 and RCA32-series) Derate linearly			0.32		W/ $^\circ C$
RCS32-series Derate linearly			0.23		W/ $^\circ C$
T_{stg} , T_J TIP32 and RCA32-series			-65 to 150		$^\circ C$
RCS32-series			-65 to 200		$^\circ C$
T_L (During soldering):					
At distance 1/8 in. (3.17 mm) from case for 10s max. TIP32 and RCA32-series			235		$^\circ C$
At a distance $\geq 1/32$ inch (0.8 mm) from seating plane for 10s max. (RCS32-series)			235		$^\circ C$

TERMINAL DESIGNATIONS



BOTTOM VIEW

JEDEC TO-220AB
TIP32 and RCA32-series



JEDEC TO-213MA
RCS32-series

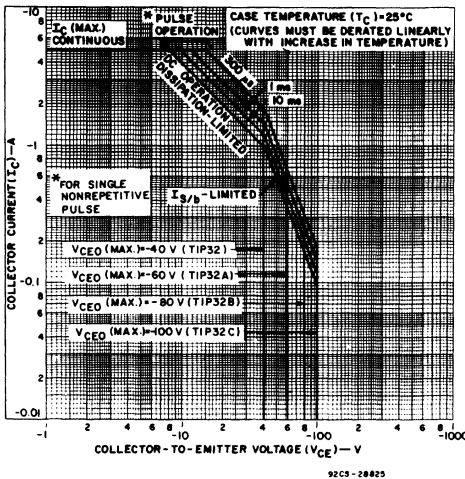


Fig. 1 - Maximum operating areas for TIP32-series.

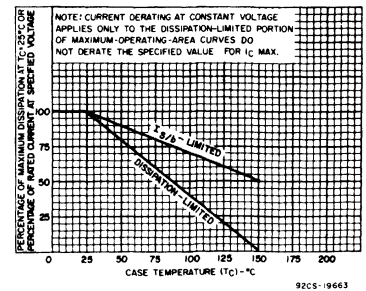


Fig. 2 - Derating curve for TIP32 and RCA32-series.

TIP32, RCA32, RCS32 Series

ELECTRICAL CHARACTERISTICS, At Case Temperature (T_C) = 25°C unless otherwise specified

CHARACTERISTIC	TEST COND.		LIMITS								Units		
	VOLTAGE V dc	CURRENT A dc	TIP32 RCA32 RCS32		TIP32A RCA32A RCS32A		TIP32B RCA32B RCS32B		TIP32C RCA32C RCS32C				
	V _{CE}	I _C	Min.	Max.	Min.	Max.	Min.	Max.	Min.	Max.			
I _{CEO} I _B =0	-30 -60		-	-0.3	-	-0.3	-	-	-	-0.3	-	-0.3	mA
I _{CES} V _{EB} =0	-40 -60 -80 -100		-	-0.2	-	-	-	-	-	-0.2	-	-0.2	mA
I _{EBO} V _{BE} =5V		0	-	-1	-	-1	-	-1	-	-1	-	-1	mA
V _{CEO(sus)} I _B =0		-0.03 ^a	-40 ^b	-	-60 ^b	-	-80 ^b	-	-100 ^b	-	-	-	V
h _{FE}	-4 -4	-1 ^a -3 ^a	25 10	- 50	25 10	- 50	25 10	- 50	25 10	- 50	-	50	
V _{BE}	-4	-3 ^a	-	-1.8	-	-1.8	-	-1.8	-	-1.8	-	-1.8	V
V _{CE(sat)} I _B = -0.375A		-3 ^a	-	-1.2	-	-1.2	-	-1.2	-	-1.2	-	-1.2	V
h _{fe} f=1 kHz	-10	-0.5	20	-	20	-	20	-	20	-	20	-	
h _{fe} l f=1 MHz	-10	-0.5	3	-	3	-	3	-	3	-	3	-	
t _{ON} (t _d +t _r) V _{CC} = -30V R _L =30Ω I _{B1} =I _{B2} =-0.1A		-1	0.2 (typ.)	-	0.2 (typ.)	-	0.2 (typ.)	-	0.2 (typ.)	-	0.2 (typ.)	-	μs
t _{OFF} (t _s +t _f) V _{CC} = -30V R _L =30Ω I _{B1} =-I _{B2} =-0.1A		-1	1 (typ.)	-	1 (typ.)	-	1 (typ.)	-	1 (typ.)	-	1 (typ.)	-	μs
R _{θJC}	TIP32 and RCA32-series		-	3.125	-	3.125	-	3.125	-	3.125	-	3.125	°C/W
	RCS32-series		-	4.3	-	4.3	-	4.3	-	4.3	-	4.3	
R _{θJA}	TIP32 and RCA32-series		-	62.5	-	62.5	-	62.5	-	62.5	-	62.5	°C/W
	RCS32-series		-	60	-	60	-	60	-	60	-	60	

^a Pulsed, pulse duration = 300 μs, duty factor ≤ 2%.

^b CAUTION: Sustaining voltage, V_{CEO(sus)}, MUST NOT be measured on a curve tracer.

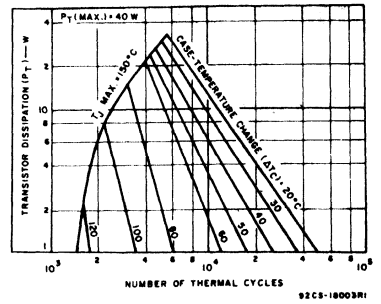


Fig. 3 — Thermal-cycling ratings for TIP32 and RCA32-series.

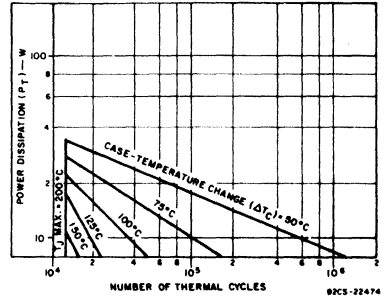


Fig. 4 — Thermal-cycling rating chart for RCS32-series.

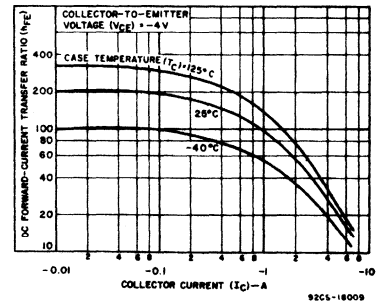


Fig. 5 — Typical dc beta characteristics for TIP32, TIP32A, TIP32B; RCA32, RCA32A, RCA32B, RCS32, RCS32A and RCS32B.

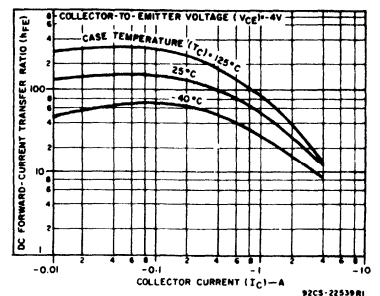


Fig. 6 — Typical dc beta characteristics for TIP32C, RCA32C and RCS32C.

TIP41, RCA41 Series

Epitaxial-Base, Silicon N-P-N VERSAWATT Transistors

For Power-Amplifier and High-Speed-Switching Applications

The RCA-TIP41 and RCA41-series are epitaxial-base, silicon n-p-n transistors intended for a wide variety of switching and amplifier applications, such as series and shunt regulators and driver and output stages of high-fidelity amplifiers. These power transistors are designed for complementary use

with devices in the TIP42 and RCA42-series. They differ from each other in voltage ratings. They are supplied in the JEDEC TO-220AB straight lead version of the VERSAWATT package, and can be provided in formed-lead configurations upon request.

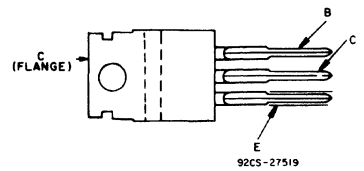
Features:

- 65 W at 25°C case temperature
- 7-A rated collector current
- Min. f_T of 3 MHz at 10 V, 500 mA
- Designed for complementary use with TIP42 and RCA42-series p-n-p types

MAXIMUM RATINGS, Absolute-Maximum Values:

	TIP41 RCA41	TIP41A RCA41A	TIP41B RCA41B	TIP41C RCA41C	
V_{CBO}	40	60	80	100	V
V_{CEO}	40	60	80	100	V
V_{EBO}	5	5	5	5	V
I_C	7	7	7	7	A
I_{CM}	10	10	10	10	A
I_B	3	3	3	3	A
P_T :					W
At $T_C \leq 25^\circ C$	65	65	65	65	W
At $T_A \leq 25^\circ C$	2	2	2	2	W
At $T_C > 25^\circ C$	Derate linearly at _____ 0.52 _____				W/°C
T_{stg}, T_J	_____ -65 to 150 _____				°C
T_L (During soldering):	_____ _____				°C
At distance 1/8 in. (3.17 mm) from case for 10 s max.	_____ 235 _____				°C

TERMINAL DESIGNATIONS



BOTTOM VIEW

JEDEC TO-220AB

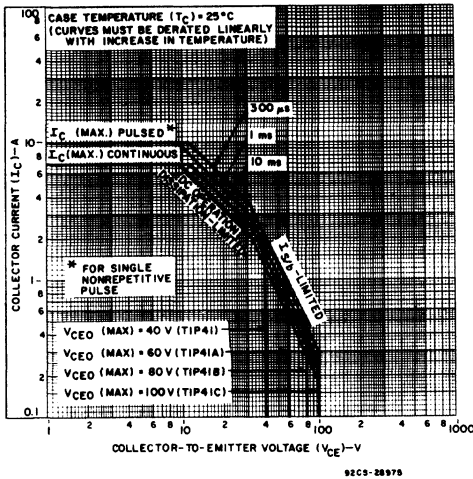


Fig. 1 — Maximum operating areas for all types.

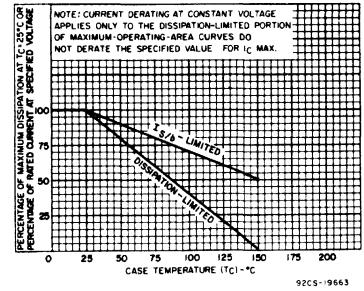


Fig. 2 — Derating curves for all types.

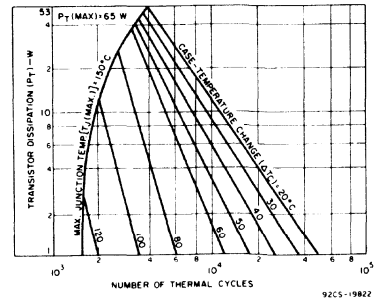


Fig. 3 — Thermal-cycling ratings for all types.

TIP41, RCA41 Series

ELECTRICAL CHARACTERISTICS, At Case Temperature (T_C) = 25°C

CHARACTERISTIC	TEST CONDITIONS		LIMITS								Units
	Voltage V dc	Current A dc	TIP41 RCA41		TIP41A RCA41A		TIP41B RCA41B		TIP41C RCA41C		
	V_{CE}	I_C	Min.	Max.	Min.	Max.	Min.	Max.	Min.	Max.	
I_{CEO} $I_B=0$	30		-	0.7	-	0.7	-	-	-	-	mA
	60		-	-	-	-	-	0.7	-	0.7	
I_{CES} $V_{BE}=0$	40		-	0.4	-	-	-	-	-	-	mA
	60		-	-	-	0.4	-	-	-	-	
	80		-	-	-	-	-	0.4	-	-	
	100		-	-	-	-	-	-	-	0.4	
I_{EBO} $V_{BE}=-5$ V		0	-	1	-	1	-	1	-	1	mA
$V_{CEO(sus)}$ $I_B=0$		0.03 ^a	40 ^b	-	60 ^b	-	80 ^b	-	100 ^b	-	V
h_{FE}	4	0.3 ^a	30	-	30	-	30	-	30	-	
	4	3 ^a	15	150	15	150	15	150	15	150	
V_{BE}	4	6 ^a	-	2.2	-	2.2	-	2.2	-	2.2	V
$V_{CE(sat)}$ $I_B=0.6$ A		6 ^a	-	2	-	2	-	2	-	2	V
h_{fe} f=1 kHz	10	0.5	20	-	20	-	20	-	20	-	
$ h_{fe} $ f=1 MHz	10	0.5	3	-	3	-	3	-	3	-	
t_{ON} ($t_d + t_r$) $V_{CC}=30$ V, $R_L=5$ Ω , $I_{B1}=I_{B2}=0.6$ A		6	0.6 (typ.)		0.6 (typ.)		0.6 (typ.)		0.6 (typ.)		μ s
t_{OFF} ($t_s + t_f$) $V_{CC}=30$ V, $R_L=5$ Ω , $I_{B1}=I_{B2}=0.6$ A		6	1.4 (typ.)		1.4 (typ.)		1.4 (typ.)		1.4 (typ.)		
$R_{\theta JC}$			-	1.92	-	1.92	-	1.92	-	1.92	$^{\circ}$ C/W
$R_{\theta JA}$			-	62.5	-	62.5	-	62.5	-	62.5	

^a Pulsed, pulse duration = 300 μ s, duty factor \leq 2%.

^b CAUTION: Sustaining voltage, $V_{CEO(sus)}$, MUST NOT be measured on a curve tracer.

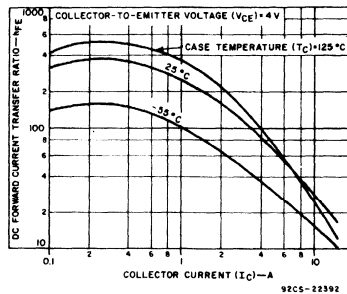


Fig. 4 — Typical dc beta characteristics for all types.

TIP42, RCA42 Series

Epitaxial-Base, Silicon P-N-P VERSAWATT Transistors

For Power-Amplifier and High-Speed-Switching Applications

The RCA-TIP42 and RCA42 series are epitaxial-base silicon p-n-p transistors intended for a wide variety of switching and amplifier applications, such as series and shunt regulators and driver and output stages of high-fidelity amplifiers. These power transistors are designed for complementary use with devices in the TIP41 and RCA41-series. They differ from each other in voltage ratings.

They are supplied in the JEDEC TO-220AB straight-lead version of the VERSAWATT package, and can be provided in formed-lead configurations upon request.

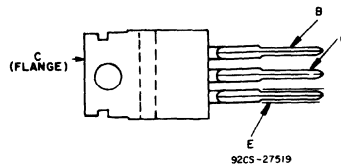
Features:

- 65 W at 25°C case temperature
- 7 A rated collector current
- Min. f_T of 3 MHz at 10 V, 500 mA
- Designed for complementary use with TIP41 and RCA41-series n-p-n types

MAXIMUM RATINGS, Absolute-Maximum Values:

	TIP42	TIP42A	TIP42B	TIP42C	
V_{CBO}	-40	-60	-80	-100	V
V_{CEO}	-40	-60	-80	-100	V
V_{EBO}	-5	-5	-5	-5	V
I_C	-7	-7	-7	-7	A
I_{CM}	-10	-10	-10	-10	A
I_B	-3	-3	-3	-3	A
P_T :					
At $T_C < 25^\circ C$	65	65	65	65	W
At $T_A < 25^\circ C$	2	2	2	2	W
At $T_C > 25^\circ C$	Derate linearly at _____ 0.52 _____				W/°C
T_{stg}, T_J	_____ -65 to 150 _____				°C
T_L (During soldering):	_____ _____				°C
At distance 1/8 in. (3.17 mm) from case for 10 s max.	_____ 235 _____				°C

TERMINAL DESIGNATIONS



BOTTOM VIEW

JEDEC TO-220AB

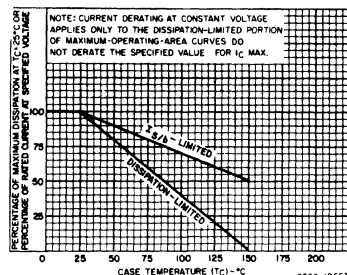


Fig. 2 - Derating curve for all types.

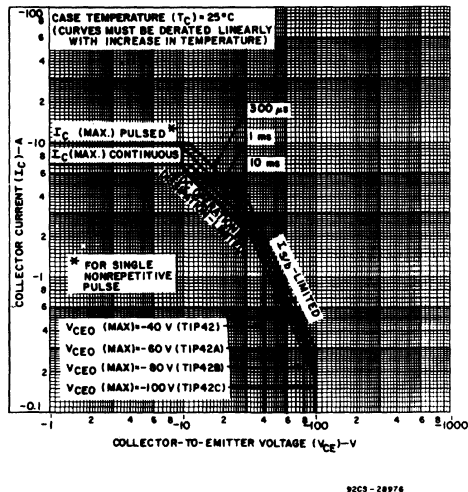


Fig. 1 - Maximum operating areas for all types.

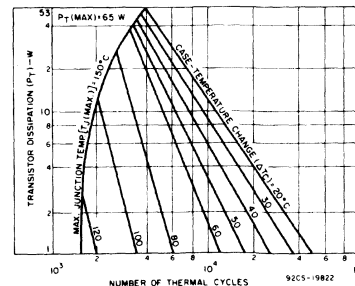


Fig. 3 - Thermal-cycling ratings for all types.

TIP42, RCA42 Series

ELECTRICAL CHARACTERISTICS, At Case Temperature (T_C) = 25°C

CHARACTERISTICS	TEST COND.		LIMITS								UNITS			
	VOLTAGE V dc	CURRENT A dc	TIP42 RCA42		TIP42A RCA42A		TIP42B RCA42B		TIP42C RCA42C					
	V _{CE}	I _C	Min.	Max.	Min.	Max.	Min.	Max.	Min.	Max.				
I _{CEO} I _B = 0	- 30 - 60		-	-0.7	-	-0.7	-	-	-	-	-0.7	-	-0.7	mA
I _{CES} V _{EB} = 0	- 40 - 60 - 80 - 100		-	-0.4	-	-	-	-	-	-	-	-	-	mA
I _{EBO} V _{BE} = -5 V		0	-	-1	-	-1	-	-1	-	-1	-	-1	mA	
V _{CEO(sus)} I _B = 0		-0.03 ^a	-40 ^b	-	-60 ^b	-	-80 ^b	-	-100 ^b	-	-	-	V	
h _{FE}	- 4 - 4	-0.3 ^a -3 ^a	30 15	- 150	30 15	- 150	30 15	- 150	30 15	- 150	30 15	- 150		
V _{BE}	-4	-6 ^a	-	-2.2	-	-2.2	-	-2.2	-	-2.2	-	-2.2	V	
V _{CE(sat)} I _B = -0.6 A		-6 ^a	-	-2	-	-2	-	-2	-	-2	-	-2	V	
h _{fe} f = 1 kHz	-10	-0.5	20	-	20	-	20	-	20	-	20	-		
h _{fe} f = 1 MHz	-10	-0.5	3	-	3	-	3	-	3	-	3	-		
t _{ON} (t _d + t _r) V _{CC} = -30 V R _L = 5 Ω I _{B1} = I _{B2} = -0.6 A		-6	0.3 (typ.)		0.3 (typ.)		0.3 (typ.)		0.3 (typ.)		0.3 (typ.)		μs	
t _{OFF} (t _s + t _f) V _{CC} = -30 V R _L = 5 Ω I _{B1} = I _{B2} = -0.6 A		-6	0.7 (typ.)		0.7 (typ.)		0.7 (typ.)		0.7 (typ.)		0.7 (typ.)		μs	
R _{θJC}			-	1.92	-	1.92	-	1.92	-	1.92	-	1.92	°C/W	
R _{θJA}			-	62.5	-	62.5	-	62.5	-	62.5	-	62.5	°C/W	

^a Pulsed, pulse duration = 300 μs, duty factor ≤ 2%.

^b CAUTION: Sustaining voltage, V_{CEO(sus)}, MUST NOT be measured on a curve tracer.

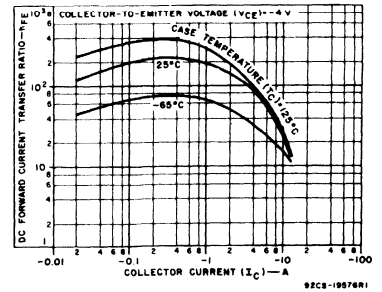


Fig. 4 - Typical dc beta characteristics for TIP42, TIP42A, TIP42B, RCA42, RCA42A and RCA42B.

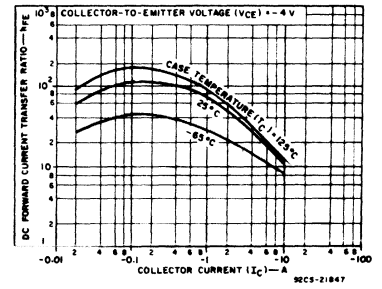


Fig. 5 - Typical dc beta characteristics for TIP42C and RCA42C.

TIP47, TIP48, TIP49, TIP50

High-Voltage Silicon N-P-N VERSAWATT Transistors

For High-Speed Switching and Linear-Amplifier Applications

The RCA-TIP47, TIP48, TIP49, and TIP50 are silicon n-p-n transistors with pi-nu construction. Typical applications for these transistors include high-voltage switches and switching regulators. TV horizontal-deflection circuits, power supplies, and TV audio-

output circuits. They are supplied in the JEDEC TO-220AB straight-lead version of the VERSAWATT package, and can be provided in formed-lead configurations upon request.

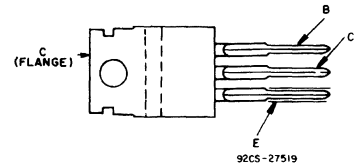
Features:

- Rugged clip-type pellet attachment
- Glass passivated chip
- VERSAWATT package (molded silicone plastic)
- Thermal-cycling ratings
- Maximum safe-area-of-operation curves

MAXIMUM RATINGS, Absolute-Maximum Values:

	TIP47	TIP48	TIP49	TIP50	
V_{CBO}	350	400	450	500	V
$V_{CEO(sus)}$	250	300	350	400	V
V_{EBO}	5	5	5	5	V
I_C	1	1	1	1	A
I_{CM}	2	2	2	2	A
I_B	0.6	0.6	0.6	0.6	A
P_T :					
T_C up to 25°C	40	40	40	40	W
T_C above 25°C	Derate linearly		0.32		W/°C
T_A up to 25°C			1.8		W
T_{stg}, T_J			-65 to 150		°C
T_L :					
At distance $\geq 1/8$ in. (3.17 mm) from seating plane for 10 s max.			235		°C

TERMINAL DESIGNATIONS



BOTTOM VIEW

JEDEC TO-220AB

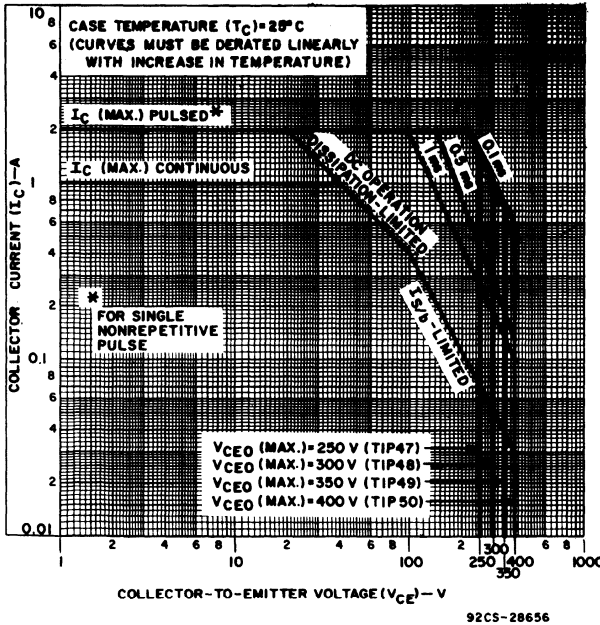


Fig.1 - Maximum operating areas for all types.

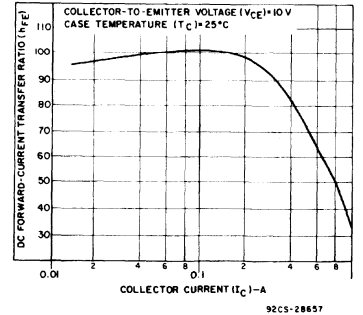


Fig.2 - Typical dc beta characteristics for all types.

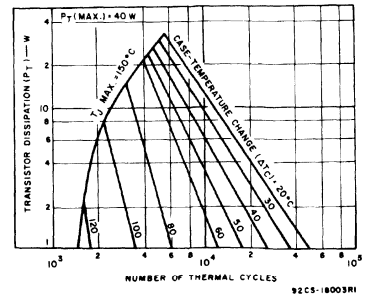


Fig.3 - Thermal-cycling rating chart for all types.

TIP47, TIP48, TIP49, TIP50

ELECTRICAL CHARACTERISTICS, At Case Temperature (T_C) = 25°C unless otherwise specified

CHARACTERISTIC	TEST COND.		LIMITS								UNITS
	VOLTAGE V dc	CURRENT A dc	TIP47		TIP48		TIP49		TIP50		
			Min.	Max.	Min.	Max.	Min.	Max.	Min.	Max.	
I_{CEO} $I_B = 0$ $R_{BE} = 1000 \Omega$	150 200 250 300		-	1	-	1	-	1	-	1	mA
I_{CES} $V_{EB} = 0$	350 400 450 500		-	1	-	1	-	1	-	1	mA
I_{EBO} $V_{BE} = -5 V$		0	-	1	-	1	-	1	-	1	mA
h_{FE}	10 10	1 ^a 0.03 ^a	10 30	- 150	10 30	- 150	10 30	- 150	10 30	- 150	
$V_{CE(sus)}$ $I_B = 0$		0.3 ^a	250 ^b	-	300 ^b	-	350 ^b	-	400 ^b	-	V
V_{BE}	10	1 ^a	-	1.5	-	1.5	-	1.5	-	1.5	V
$V_{CE(sat)}$ $I_B = 0.2 A$		1 ^a	-	1	-	1	-	1	-	1	V
$ h_{fe} $ $f = 1 MHz$	10	0.2	5	-	5	-	5	-	5	-	
f_T $f = 1 MHz$	10	0.2	5	-	5	-	5	-	5	-	MHz
h_{fe} $f = 1 kHz$	10	0.2	25	-	25	-	25	-	25	-	
$I_{S/b}$ $t = 0.5 s$	100	-	0.4	-	0.4	-	0.4	-	0.4	-	A
$t_{ON} (t_d + t_r)^c$ $V_{CC} = 200 V$		1	0.2 (typ.)		0.2 (typ.)		0.2 (typ.)		0.2 (typ.)		μs
t_s^c $V_{CC} = 200 V$		1	2 (typ.)		2 (typ.)		2 (typ.)		2 (typ.)		μs
t_f^c $V_{CC} = 200 V$		1	0.5 (typ.)		0.5 (typ.)		0.5 (typ.)		0.5 (typ.)		μs
$R_{\theta JC}$			-	3.12	-	3.12	-	3.12	-	3.12	$^{\circ}C/W$
$R_{\theta JA}$			-	70	-	70	-	70	-	70	$^{\circ}C/W$

a Pulsed, pulse duration = 300 μs , duty factor $\leq 2\%$.
 b CAUTION: Sustaining voltage, $V_{CE(sus)}$, MUST NOT be measured on a curve tracer.
 c $I_{B1} = I_{B2} = 0.1 A$.

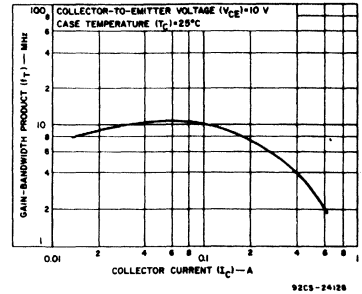


Fig. 4 - Typical gain-bandwidth characteristics for all types.

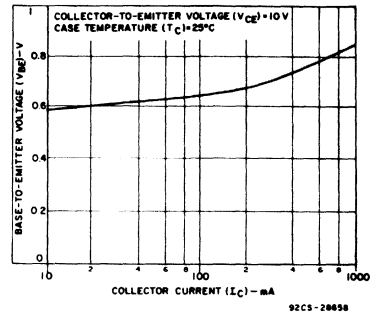


Fig. 5 - Typical base-to-emitter voltage vs. collector current.

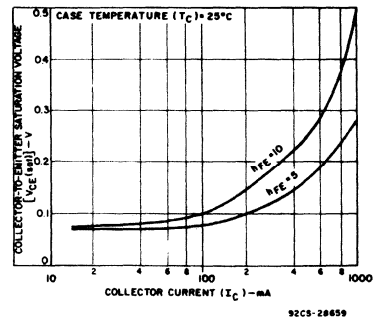


Fig. 6 - Typical saturation-voltage characteristics for all types.

TIP120, TIP121, TIP122, RCA120, RCA121, RCA122

8-Ampere N-P-N Darlington Power Transistors

60, 80, and 100 Volts, 65 Watts
 Gain of 500 at 0.5 A
 Gain of 1000 at 3 A

The RCA-TIP120, TIP121, TIP122, RCA 120, RCA121 and RCA122 are monolithic n-p-n silicon Darlington transistors designed for low- and medium-frequency power applications. The double epitaxial construction of these devices provides good forward and reverse second-breakdown capability; their high gain makes it possible for them to be driven directly from integrated circuits.

These devices are supplied in the JEDEC TO-220AB straight-lead version of the VERSA-WATT package. Optional lead configurations are available upon request. For information, contact your nearest RCA Sales Office.

The TIP120, TIP121 and TIP122 are n-p-n complements of the TIP125, TIP126 and TIP127. The RCA120 and RCA121 are n-p-n complements of the RCA125 and RCA126.

Features:

- Operates from IC without predriver
- Low leakage at high temperature
- High reverse second-breakdown capability

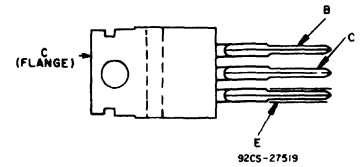
Applications:

- Power switching
- Hammer drivers
- Series and shunt regulators
- Audio amplifiers

MAXIMUM RATINGS, Absolute-Maximum Values:

	TIP120 RCA120	TIP121 RCA121	TIP122 RCA122	
V_{CB0}	60	80	100	V
$V_{CER(sus)}$ $R_{BE} = 100 \Omega$	60	80	100	V
$V_{CEO(sus)}$	60	80	100	V
$V_{CEV(sus)}$ $V_{BE} = -1.5 V$	60	80	100	V
V_{EBO}	5	5	5	V
I_C	8	8	8	A
I_{CM}	10	10	10	A
I_B	0.25	0.25	0.25	A
P_T				W
T_C up to 25°C	65	65	65	W
T_C above 25°C	Derate linearly at			W/°C
T_{stg}, T_J	-65 to 150			°C
t_L	At distance $\geq 1/8$ in. (3.17 mm) from case for 10 s max.			°C

TERMINAL DESIGNATIONS



BOTTOM VIEW
JEDEC TO-220AB

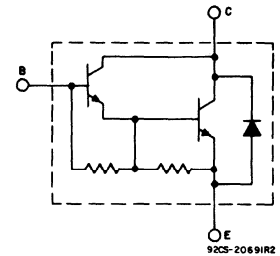


Fig. 1 - Schematic diagram for all types.

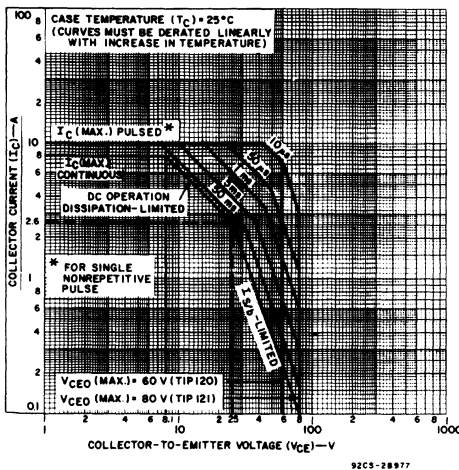


Fig. 2 - Maximum operating areas for TIP120 and TIP121.

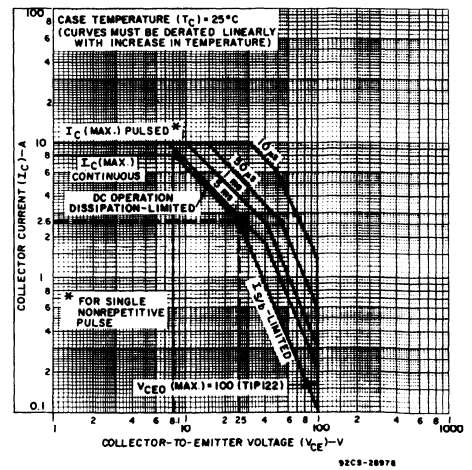


Fig. 3 - Maximum operating areas for TIP122.

TIP120, TIP121, TIP122, RCA120, RCA121, RCA122

ELECTRICAL CHARACTERISTICS, At Case Temperature (T_C) = 25°C

CHARACTERISTIC	TEST CONDITIONS				LIMITS						UNITS
	Voltage V dc		Current A dc		TIP120 RCA120		TIP121 RCA121		TIP122 RCA122		
	V_{CE}	V_{BE}	I_C	I_B	Min.	Max.	Min.	Max.	Min.	Max.	
I_{CBO} $I_E=0$	60 80 100				—	0.2	—	0.2	—	—	mA
I_{CEO}	30 40 50			0 0 0	—	0.5	—	0.5	—	0.5	
I_{EBO}		-5	0		—	3	—	3	—	3	
$V_{CE0}(sus)$			0.2 ^a	0	60	—	80	—	100	—	V
h_{FE}	3 3		3 ^a 0.5 ^a		1000 500	—	1000 500	—	1000 500	—	
V_{BE}	3		3 ^a		—	2.5	—	2.5	—	2.5	V
$V_{CE}(sat)$			3 ^a 5 ^a	0.012 0.02	—	2 3	—	2 3	—	2 3	V
h_{fe} f=1 kHz	5		1		1000	—	1000	—	1000	—	
$ h_{fe} $ f=1 MHz	5		1		20	—	20	—	20	—	
C_{obo} $V_{CB}=10$ V f=1 MHz					—	200	—	200	—	200	pF
E_S/b L=12 mH, $R_{BE}=100 \Omega$		-1.5	4.5		120	—	120	—	120	—	mJ
I_S/b t=0.5 s non- rep. pulse	25				2.6	—	2.6	—	2.6	—	A
$R_{\theta JC}$					—	1.92	—	1.92	—	1.92	°C/W

^a Pulsed, pulse duration = 300 μ s, duty factor \leq 2%.

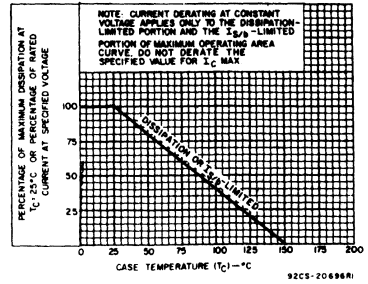


Fig. 4 - Derating curve for all types.

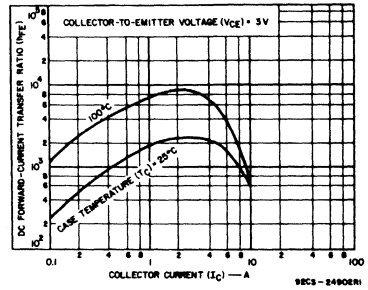


Fig. 5 - Typical dc beta characteristics for all types.

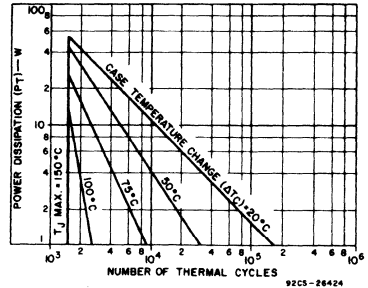


Fig. 6 - Thermal-cycling rating chart for all types.

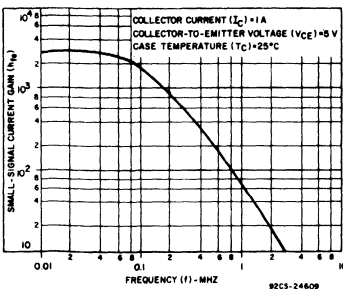


Fig. 7 - Typical small-signal current gain for all types.

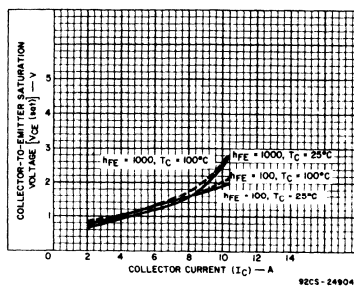


Fig. 8 - Typical saturation characteristics for all types.

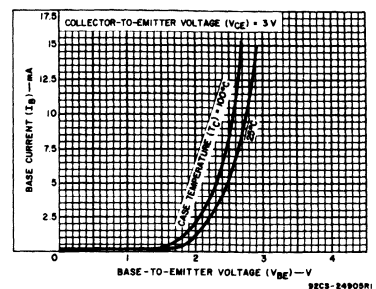


Fig. 9 - Typical input characteristics for all types.

TIP120, TIP121, TIP122, RCA120, RCA121, RCA122

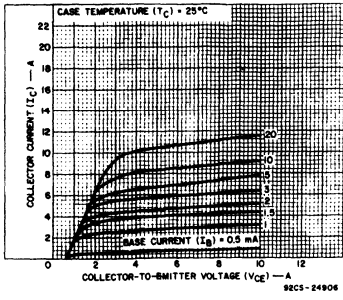


Fig. 10 - Typical output characteristics for all types.

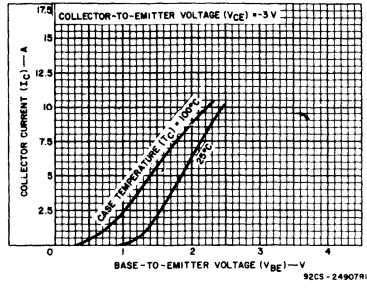


Fig. 11 - Typical transfer characteristics for all types.

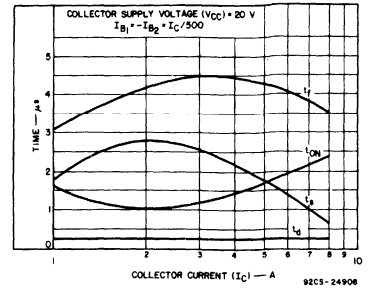


Fig. 12 - Typical saturated switching characteristics for all types.

TIP125, TIP126, TIP127, RCA125, RCA126

8-Ampere P-N-P Darlington Power Transistors

-60, -80, and -100 Volts, 65 Watts
Gain of 1000 at -3 A
Gain of 500 at -0.75 A

The RCA-TIP125, TIP126, TIP127, RCA 125 and RCA126 are monolithic silicon p-n-p Darlington transistors designed for low- and medium-frequency power applications. The high gain of these devices makes it possible for them to be driven directly from integrated circuits.

These devices are supplied in the JEDEC TO-220AB straight-lead version of the VER-SAWATT package. Optional lead configurations are available upon request. For information, contact your nearest RCA Sales Office.

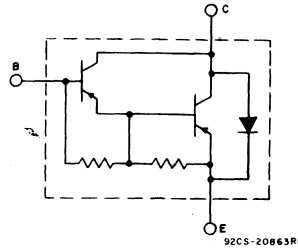


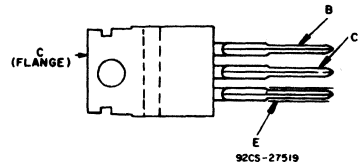
Fig. 1 - Schematic diagram for all types.

The TIP125, TIP126 and TIP127 are p-n-p complements of the TIP120, TIP121 and TIP122. The RCA125 and RCA126 are p-n-p complements of the RCA120 and RCA121.

Features:

- Operates from IC without predriver
 - Low leakage at high temperature
 - High reverse second-breakdown capability
- Applications:**
- Power switching
 - Hammer drivers
 - Series and shunt regulators
 - Audio amplifiers

TERMINAL DESIGNATIONS



BOTTOM VIEW

JEDEC TO-220AB

MAXIMUM RATINGS, Absolute-Maximum Values:

	TIP125 RCA125	TIP126 RCA126	TIP127 -	
V_{CBO}	-60	-80	-100	V
$V_{CEO(sus)}$	-60	-80	-100	V
V_{EBO}	-5	-5	-5	V
I_C	-8	-8	-8	A
I_{CM}	-15	-15	-15	A
I_B	-0.25	-0.25	-0.25	A
P_T	65	65	65	W
$T_C \leq 25^\circ C$	TIP125, TIP126, TIP127 Derate linearly at 0.52 W/°C			W/°C
$T_C > 25^\circ C$	RCA125, RCA126 Derate linearly to -65 to 150			°C
T_{stg}, T_J	-65 to 150			°C
T_L	At distance 1/18 in. (3.17 mm) from case for 10s max. 235			°C

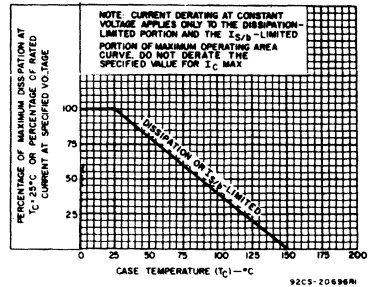


Fig. 3 - Dissipation derating curve for all types.

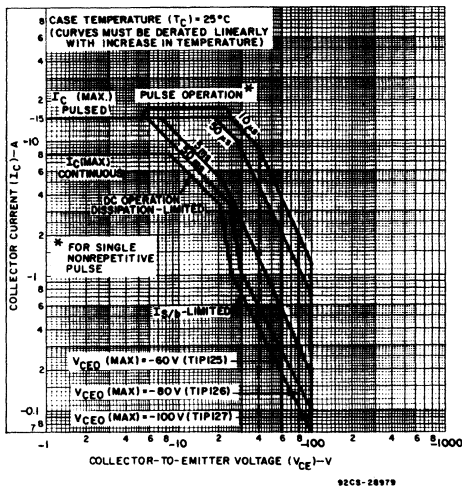


Fig. 2 - Maximum operating areas for all types.

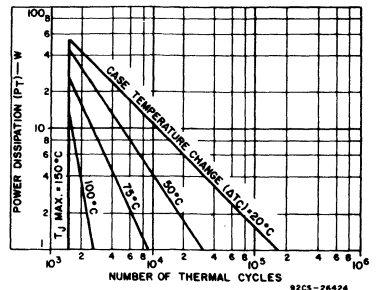


Fig. 4 - Thermal-cycling rating chart for all types.

TIP125, TIP126, TIP127, RCA125, RCA126

ELECTRICAL CHARACTERISTICS, At Case Temperature (T_C) = 25°C

CHARACTERISTIC	TEST CONDITIONS			LIMITS					UNITS		
	Voltage V dc	Current A dc		TIP125 RCA125		TIP126 RCA126		TIP127 —			
		V_{CE}	I_C	I_B	Min.	Max.	Min.	Max.		Min.	Max.
I_{CEO}	-30 -40 -50		0	—	-0.5	—	—	—	—	—	mA
I_{EBO} $V_{BE}=5V$		0		—	-10	—	-10	—	-10	—	mA
$V_{CEQ}(sus)$		-0.03 ^a	0	-60	—	-80	—	-100	—	—	V
h_{FE}	-3 -3	-0.75 ^a -3 ^a		500 1000	—	500 1000	—	500 1000	—	—	
V_{BE}	-3	-3 ^a		—	-2.5	—	-2.5	—	-2.5	—	V
$V_{CE}(sat)$		-3 ^a -5 ^a	-0.012 -0.02	—	-2 -4	—	-2 -4	—	-2 -4	—	V
h_{fe} f=1 kHz	-5	-1		1000	—	1000	—	1000	—	—	
$ h_{fe} $ f=1 MHz	-5	-1		20	—	20	—	20	—	—	
$I_{S/b}$ t=1-s nonrep. pulse	-20			-3.2	—	-3.2	—	-3.2	—	—	A
$R_{\theta JC}$				—	1.92	—	1.92	—	1.92	—	°C/W

^a Pulsed: Pulse duration = 300 μs, duty factor ≤ 2%.

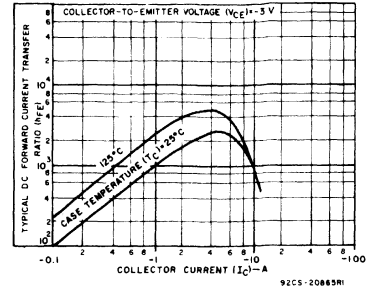


Fig. 5 – Typical dc beta characteristics for all types.

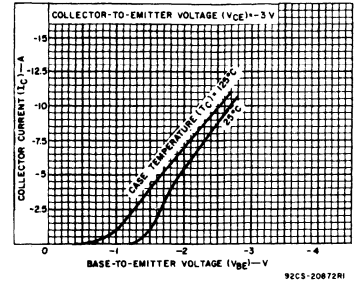


Fig. 6 – Typical transfer characteristics for all types.

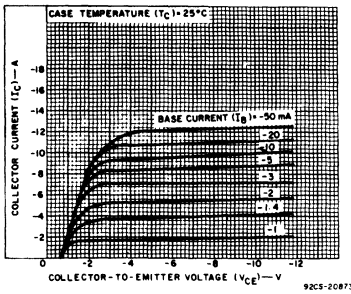


Fig. 7 – Typical output characteristics for all types.

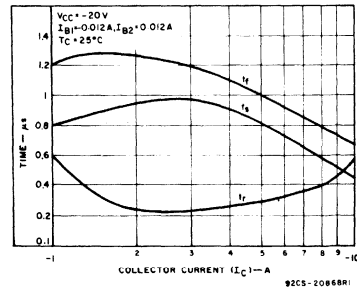


Fig. 8 – Typical saturated switching-time characteristics for all types.

CH2102, CH2270, CH2405, CH3053, CH3439, CH3440, CH4036, CH4037, CH5320-CH5323, CH6479

Unmounted and Unencapsulated N-P-N and P-N-P Silicon Power Transistor Chips

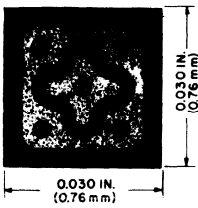
Features:

- Prepared and tested for use in hybrid circuits
- h_{FE} ratings from 30 to 50 (min.)
- ICBO leakage ratings in the 10 μ A to 1 mA range
- VCEO ratings up to 90 V on planar transistor chips; up to 325 V on passivated mesa types
- IC up to 12 A (CH6479)

The transistor chip families described in this bulletin are selected from the broad line of RCA discrete power transistors. Known also as pellets or dies, these chips represent the essential electronic portion of the transistor. They are especially suited for direct mounting on a heat sink in hybrid circuits. The n-p-n and p-n-p types can be used either singly or in complementary-pair configurations for large-signal medium-power applications.

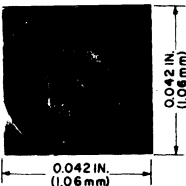
All of the chip families shown are double-diffused epitaxial types. Six of the families are of planar construction; the other is of a passivated mesa construction. The oxide layer that results from conventional planar processing protects the planar types. The junctions and surfaces of the mesa transistor chips are protected by deposited glass-passivated coverings.

2N2102 Family (n-p-n)



- (B) 4 Base Bonding Areas 0.008 in. (0.20 mm) diameter
- (E) Emitter Bonding Area 0.008 in. (0.20 mm) diameter

2N3439 Family (n-p-n)



- (B) Base Bonding Area 0.005 in. (0.13 mm) diameter
- (E) Emitter Bonding Area 0.005 in. (0.13 mm) diameter

Aluminum has been deposited at the base and emitter electrodes of all the transistor chips for ease of bonding. The base and emitter bonding areas on each chip will accommodate up to a 0.003-inch (0.076-mm)-diameter bond wire except for the CH6479 which will accommodate a 0.010-inch (0.254-mm) wire. Either thermo-compression or ultrasonic bonding can be used to attach gold wires to these electrodes; aluminum wires can also be bonded by conventional ultrasonic techniques.

The collector contact, which is on the underside of the chip, has been metallized with gold for all of the chips except CH6479. For all of the chips, the collector can be attached directly to a heat sink by adhesive or by gold-silicon or gold-germanium eutectic bonding methods.

The CH6479, because of its large size, must be mounted on a heat sink made of material with thermal expansion coefficient close to that of silicon; suitable materials are molybdenum or beryllium oxide. A special cleaning step is required in mounting the CH6479.

All of the chips must be mounted in an inert or reduced atmosphere. The chips must not be subjected to more than 400°C for a maximum of 1 minute. Because of the specially prepared surfaces of the chips (except as noted for the CH6479), etching of the pellets or the use of flux is not recommended.

The chips are supplied in plastic containers. Each chip is securely held in a recessed partition of the container by a clear plastic cover that also protects the surface from dust and abrasion. For additional protection, the container is sealed in a clear plastic bag. If the sealed shipping container is opened or broken, ruptured, punctured, or damaged in any way, the chips must be stored at a temperature of not more than 40°C and a relative humidity of not more than 50% in a clean, dust-free environment. If the sealed shipping container is damaged on receipt as described above, the product should be immediately returned to RCA.

These unmounted and unencapsulated chips are tested electrically and visually inspected to meet the specifications shown on the following pages. Written notification of non-conformance to such specifications must be made to RCA within 90 days of the date of the shipment by RCA. RCA assumes no responsibility for chips which have been subjected to further processing, such as, but not limited to, lead-bonding or pellet-mounting operations.

RCA has the right to change the chip design and processing without notification.

Assistance in determining proper mounting and bonding procedures is available from RCA.

CH2102 CH2270 CH2405 CH3053

RCA-CH2102, CH2270, CH2405, and CH3053 are double-diffused n-p-n epitaxial planar transistor chips similar to RCA-2N2102, 2N2270, 2N2405, and 2N3053 transistors, respectively. They

can be used either singly or in complementary-pair configurations with RCA p-n-p chips CH4036 and CH4037 for large-signal medium-power applications.

ELECTRICAL CHARACTERISTICS, at Chip Temperature = 25°C

Characteristic	Symbol	Test Conditions				Limits								Units
		Voltage V dc		Current mA dc		CH2102		CH2270		CH2405		CH3053		
		V _{CB}	V _{CE}	I _C	I _E	Min.	Max.	Min.	Max.	Min.	Max.	Min.	Max.	
Collector Cutoff Current	ICBO	60				10		10		10		10	μ A	
Emitter-to-Base Breakdown Voltage	V _{(BR)EBO}			0.01	5		5		5		5		V	
Collector-to-Emitter Sustaining Voltage: Base open ^a	V _{CEO(sus)}		20		60		45		90		30		V	
DC Forward-Current Transfer Ratio ^b	h _{FE}	10	150		50		50		50		50			

CH3439 CH3440

RCA-CH3439 and CH3440 are passivated mesa n-p-n transistor chips similar to those used in RCA-2N3439 and 2N3440 high-voltage transistors. Because of their high breakdown voltages, good high-fre-

quency response, and fast switching speeds, these transistor chips can be used in high-voltage differential and operational amplifiers, high-voltage inverters and high-voltage, low-current switching regulators.

ELECTRICAL CHARACTERISTICS, at Chip Temperature = 25°C

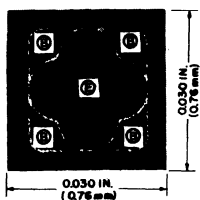
Characteristic	Symbol	Test Conditions				Limits				Units
		Voltage V dc		Current mA dc		CH3439		CH3440		
		V _{CB}	V _{CE}	I _C	I _E	Min.	Max.	Min.	Max.	
Collector Cutoff Current	ICBO	200					20		50	μ A
Emitter-to-Base Breakdown Voltage	V _{(BR)EBO}			0.02	5		5			V
Collector-to-Emitter Sustaining Voltage: Base open ^a	V _{CEO(sus)}		20		325		250			V
DC Forward-Current Transfer Ratio ^b	h _{FE}		10	20		30		30		

^aCAUTION: This voltage MUST NOT be measured on a curve tracer. ^bPulse tested; 2% duty factor, less than or equal to 300 μ s duration.

CH2102, CH2270, CH2405, CH3053, CH3439, CH3440, CH4036, CH4037, CH5320-CH5323, CH6479

Unmounted and Unencapsulated N-P-N and P-N-P Silicon Power Transistor Chips (Cont'd)

2N4036 Family (p-n-p)



- (B) 4 Base Bonding Areas 0.008 in. (0.20 mm) diameter
- (E) Emitter Bonding Area 0.008 in. (0.20 mm) diameter

CH4036 CH4037

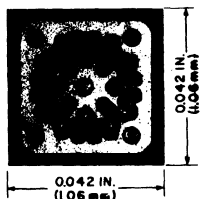
RCA-CH4036 and CH4037 are double-diffused p-n-p epitaxial planar transistor chips similar to RCA-2N4036 and 2N4037 transistors. Their high-voltage ratings and heat-dissipating ability make them ideal

for amplifying large signals at a medium power level. They can be used singly or as complements of RCA n-p-n chips CH2102, CH2270, CH2405, and CH3053.

ELECTRICAL CHARACTERISTICS, at Chip Temperature = 25°C

Characteristic	Symbol	Test Conditions				Limits				Units
		Voltage V dc		Current mA dc		CH4036		CH4037		
		V _{CB}	V _{CE}	I _C	I _E	Min.	Max.	Min.	Max.	
Collector Cutoff Current	I _{CBO}	60					-10		-10	μA
Emitter to Base Breakdown Voltage	V _{(BR)EBO}				-0.01	-6.5		-6.6		V
Collector to Emitter Sustaining Voltage: Base open ^a	V _{CEO(sus)}			-20		-65		-40		V
DC Forward Current Transfer Ratio ^b	h _{FE}		-10	-150		35		35		

2N5320 Family (n-p-n)



- (B) 4 Base Bonding Areas 0.008 in. (0.20 mm) diameter
- (E) Emitter Bonding Area 0.008 in. (0.20 mm) diameter

CH5320 CH5321

RCA-CH5320 and CH5321 are double-diffused n-p-n epitaxial planar transistor chips similar to RCA-2N5320 and 2N5321

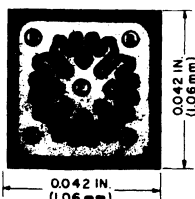
transistors. They can be used singly or as complements of RCA p-n-p chips CH5322 and CH5323.

ELECTRICAL CHARACTERISTICS, at Chip Temperature = 25°C

Characteristic	Symbol	Test Conditions				Limits				Units
		Voltage V dc		Current mA dc		CH5320		CH5321		
		V _{CB}	V _{CE}	I _C	I _E	Min.	Max.	Min.	Max.	
Collector Cutoff Current:	I _{CBO}	60					10		10	μA
Emitter to Base Breakdown Voltage	V _{(BR)EBO}				0.01	5		5		V
Collector to Emitter Sustaining Voltage: Base open ^a	V _{CEO(sus)}			20		80		55		V
DC Forward Current Transfer Ratio ^b	h _{FE}		10	250		30		30		

^aCAUTION: This voltage MUST NOT be measured on a curve tracer. ^bPulse tested; 2% duty factor, less than or equal to 300 μs duration.

2N5323 Family (p-n-p)



- (B) 4 Base Bonding Areas 0.008 in. (0.20 mm) diameter
- (E) Emitter Bonding Area 0.008 in. (0.20 mm) diameter

CH5322 CH5323

RCA-CH5322 and CH5323 are double-diffused p-n-p epitaxial planar transistor chips similar to RCA-2N5322 and 2N5323 transistors. They can be used singly or as

complements of RCA n-p-n chips CH5320 and CH5321 for amplifying large signals at a medium power level.

ELECTRICAL CHARACTERISTICS, at Chip Temperature = 25°C

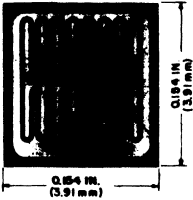
Characteristic	Symbol	Test Conditions				Limits				Units
		Voltage V dc		Current mA dc		CH5322		CH5323		
		V _{CB}	V _{CE}	I _C	I _E	Min.	Max.	Min.	Max.	
Collector Cutoff Current	I _{CBO}	-60					-10		-10	μA
Emitter to Base Breakdown Voltage	V _{(BR)EBO}				-0.01	-5		-5		V
Collector to Emitter Sustaining Voltage: Base open ^a	V _{CEO(sus)}			-20		-80		-55		V
DC Forward Current Transfer Ratio ^b	h _{FE}		-10	-250		30		30		

**CH2102, CH2270, CH2405, CH3053, CH3439, CH3440, CH4036,
CH4037, CH5320-CH5323, CH6479**

Unmounted and Unencapsulated N-P-N and P-N-P Silicon Power Transistor Chips (Cont'd)

CH6479

2N6479 Family (n-p-n)



- (B) Base Bonding Area 0.013 in. (0.33 mm) x 0.091 in. (2.31 mm)
- (E) Emitter Bonding Area 0.013 in. (0.33 mm) x 0.091 in. (2.31 mm)

RCA-CH6479 is a double-diffused n-p-n epitaxial planar transistor chip similar to the RCA-2N6479 transistor. Radiation hardening makes this type suitable for aerospace applications, and high-switching speeds make it ideal for use in high-speed inverters, switching regulators, and military hybrid applications.

ELECTRICAL CHARACTERISTICS, at Chip Temperature = 25°C

Characteristic	Symbol	Test Conditions				Limits		Units
		Voltage V dc		Current mA dc		CH6479		
		V _{CB}	V _{CE}	I _C	I _E	Min.	Max.	
Collector Cutoff Current	I _{CBO}	100					1	mA
Emitter-to-Base Breakdown Voltage	V _{(BR)EBO}				1	5		V
Collector-to-Emitter Sustaining Voltage: Base open *	V _{CEO(sus)}			25		60		V
DC Forward-Current Transfer Ratio ^b	h _{FE}		2	500		40		

CH6479 Chip Special Clean-Up Schedule:

Before eutectic mounting, the CH6479 chip must be etched for 30 seconds in a 10% (by volume) electronic-grade hydrofluoric acid solution at 25°C ± 5°C with agitation. Normal precautions for using hydrofluoric acid should be observed. The chip must then be dried and mounted within 8 hours.

CHIP INSPECTION INFORMATION

Each lot is inspected to a 2.5% AQL (cumulative) according to Mil Std. 105 using 20 times magnification. The following defects determine the inspection criteria:

- Foreign matter adhering to the base and emitter bond areas.
- Improperly cut pellets that include a portion of another pellet.
- Bridging by the metallization which causes a short.

Blistering, lifting or absence of the aluminum metallization.

Fractures or edges within 0.0005 in. (0.013) mm of the base collector junction.

Severed base-contact rings that isolate all the bonding pads and most of the base area.

Oxide missing from the junction area.

RF Power Transistors

Technical Data

2N2857

Silicon N-P-N Epitaxial Planar Transistor

For UHF Applications in Industrial and Military Equipment

Features:

- high gain-bandwidth product— $f_T = 1000$ MHz min.
- high converter (450-to-30 MHz) gain— $G_C = 15$ dB typ. for circuit bandwidth of approximately 2 MHz
- high power gain as neutralized amplifier— $G_{pe} = 12.5$ dB min. at 450 MHz for circuit bandwidth of 20 MHz
- high power output as uhf oscillator— $P_o = \begin{cases} 30 \text{ mW min., } 40 \text{ mW typ. at } 500 \text{ MHz} \\ 20 \text{ mW typ., at } 1 \text{ GHz} \end{cases}$
- low device noise figure— $NF = \begin{cases} 4.5 \text{ dB max. as } 450 \text{ MHz amplifier} \\ 17.5 \text{ dB typ. as } 450\text{-to-}30 \text{ MHz converter} \end{cases}$
- low collector-to-base time constant— $r_b' C_c = 7$ ps typ.
- low collector-to-base feedback capacitance— $C_{cb} = 0.6$ pF typ.

Maximum Ratings, Absolute-Maximum Values:

COLLECTOR-TO-BASE VOLTAGE, V_{CB0}	30 max.	V
COLLECTOR-TO-EMITTER VOLTAGE, V_{CEO}	15 max.	V
EMITTER-TO-BASE VOLTAGE, V_{EB0}	2.5 max.	V
COLLECTOR CURRENT, I_C	40 max.	mA
TRANSISTOR DISSIPATION, P_T :		
At case temp. up to 25°C	300 max.	mW
At temperatures above 25°C	Derate at 1.72 mW/°C	
At ambient temp. up to 25°C	200 max.	mW
At temperatures above 25°C	Derate at 1.14 mW/°C	

TEMPERATURE RANGE:

Storage and Operating (Junction) -65 to +200 °C
 LEAD TEMPERATURE (During soldering):
 At distances $\geq 1/32$ inch from seating surface for 10 seconds max. 265 max. °C

* Measured at center of seating surface.

TERMINAL DESIGNATIONS



CASE
92CS-27513

JEDEC TO-72

ELECTRICAL CHARACTERISTICS, At an Ambient Temperature, $T_A = 25^\circ\text{C}$, Unless Otherwise Specified

Characteristic	Symbol	Frequency	TEST CONDITIONS						LIMITS			Units		
			Collector-to-Base Voltage V_{CB}	Collector-to-Emitter Voltage V_{CE}	Emitter-to-Base Voltage V_{EB}	DC Emitter Current I_E	DC Base Current I_B	DC Collector Current I_C	Type 2N2857					
			V	V	V	mA	mA	mA	Min.	Typ.	Max.			
Collector-Cutoff Current	I_{CBO}	TA = 25°C TA = 150°C	15 15			0 0					-	-	10 1.0	nA µA
Collector-to-Base Breakdown Voltage	BV_{CB0}					0		0.001	30	-	-	-	-	V
Collector-to-Emitter Breakdown Voltage	BV_{CEO}							0	3	15	-	-	-	V
Emitter-to-Base Breakdown Voltage	BV_{EBO}					-0.01		0	2.5	-	-	-	-	V
Static Forward-Current Transfer Ratio	h_{FE}			1				3	30	-	-	-	150	
Small-Signal Forward-Current Transfer Ratio	h_{fe}	0.001°C 100°C		6 6				2 5	50 10	-	-	-	220 19	
Collector-to-Base Feedback Capacitance	C_{cb}	0.1 to 1 ^b	10				0			-	0.6	1.0		pF
Input Capacitance	C_{ib}	0.1 to 1 ^a			0.5			0	-	1.4	-	-		pF
Collector-to-Base Time Constant	$r_b' C_c$	31.9°C	6				-2		4	7	15			ps
Small-Signal, Common-Emitter Power Gain in Neutralized Amplifier Circuit	G_{pe}	450°C		6				1.5	12.5	-	-	-	19	dB
Power Output as Oscillator	P_o	$\geq 500^d$	10				-12		30	-	-	-	-	mW
UHF Device Noise Figure	NF	450c, d, f		6					1.5	-	3.8	4.5		dB
UHF Measured Noise Figure	NF	450c, d		6					1.5	-	-	5.0		dB
VHF Device Noise Figure	NF	60b, d		6					1	-	2.2	-		dB

- a Fourth lead (case) not connected
- b Three-terminal measurement: Lead No. 1 (Emitter) and lead No. 4 (Case) connected to guard terminal.
- c Fourth lead (case) grounded.
- d Generator resistance, $R_g = 50$ ohms.
- e Generator resistance, $R_g = 400$ ohms.
- f Device noise figure is approximately 0.5 dB lower than the measured noise figure. The difference is due to the insertion loss at the input of the test circuit (0.25 dB) and the contribution of the following stages in the test setup (0.25 dB).

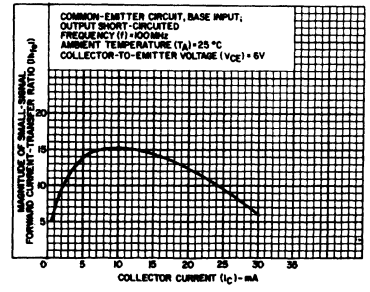


Fig. 1 - Small-signal beta characteristic for type 2N2857.

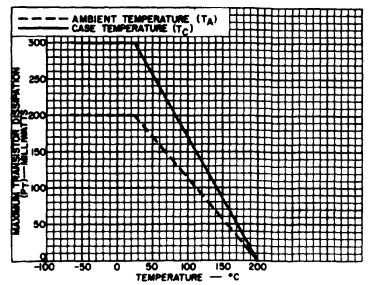


Fig. 2 - Rating chart for type 2N2857.

2N2876

Silicon N-P-N Planar Transistors

For Large-Signal, High-Power, VHF Applications in Military and Industrial Communications Equipment

Features:

- High Power Output, Unneutralized (P_{OUT}):
 10 w min. at 50 Mc } 2N2876
 3 w min. at 150 Mc }
- High Voltage Ratings:
 $V_{CBO} = 80$ volts max.
 $V_{CEO} = 60$ volts max.
- 100 per cent tested to assure freedom from second breakdown in class A operation at maximum ratings

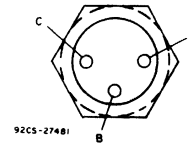
RCA-2N2876 Features:

- Low Thermal Resistance (θ_{J-C})—
 high-thermal-conductivity ceramic insulation between collector and mounting stud
- Isolated Stud Package:
 all three electrodes electrically isolated from case —for design flexibility
 heavy copper mounting stud—
 with heat sink
 pin terminals arranged on a .200" pin-circle diameter —fit commercially available sockets

MAXIMUM RATINGS, Absolute-Maximum Values:

	2N2876	
COLLECTOR-TO-BASE VOLTAGE, V_{CBO}	80	volts
COLLECTOR-TO-EMITTER VOLTAGE:		
With base open, V_{CEO}	60	volts
With $V_{BE} = -1.5$ volts, V_{CEV}	80	volts
EMITTER-TO-BASE VOLTAGE, V_{EBO}	4	volts
COLLECTOR CURRENT, I_C	2.5	amp
TRANSISTOR DISSIPATION, P_T :		
At case } up to 25°C	17.5	watts
temperatures } above 25°C	Derate linearly	100mw/°C
TEMPERATURE RANGE:		
Storage	-65 to +200	°C
Operating (Junction)	-65 to +200	°C
LEAD TEMPERATURE		
(During soldering):		
At distance $\geq 1/32"$ from ceramic wafer for 10 sec. max.	230	°C

TERMINAL DESIGNATIONS



JEDEC TO-60

ELECTRICAL CHARACTERISTICS Case Temperature = 25° C

Unless Otherwise Specified

Characteristic	Symbol	TEST CONDITIONS						LIMITS		Units
		DC Collector Volts		DC Base Volts	DC Current (Milliamperes)			2N2876		
		V_{CB}	V_{CC}	V_{BE}	I_E	I_B	I_C	Min.	Max.	
Collector-Cutoff Current	I_{CBO}	30			0			-	0.1	μA
Collector-to-Base Breakdown Voltage	BV_{CBO}				0	0.5	80	-		V
Collector-to-Emitter Breakdown Voltage (Sustaining)	$BV_{CEO(sus)}$				0	500 ^a	60	-		V
Collector-to-Emitter Breakdown Voltage	BV_{CEV}			-1.5		0.1	80	-		V
Emitter-to-Base Breakdown Voltage	BV_{EBO}				0.1	0	4	-		V
Collector-to-Emitter Saturation Voltage	$V_{CE(sat)}$					500	2.5 amp	-	1	V
Feedback Capacitance (Measured at 140 KHz)	$C_{b'c}$	30			0			-	20	pF
RF Power Output, Unneutralized	P_{out}									
Measured at 50 MHz			28			500	10 ^a	-		W
50 MHz			28			375	-	-		
150 MHz			28			275	3 ^b	-		
Gain-Bandwidth Product	f_T		28			250	200 (typ.)			MHz
Base Spreading Resistance (Measured at 400 MHz)	$r_{bb'}$		28			250	6.0 (typ.)			ohms
Collector-to-Case Capacitance	C_C						-		6	pF

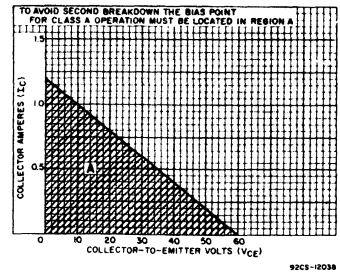


Fig. 1 - Region of safe operation (without second breakdown) in class A service for type 2N2876.

^a Pulsed. Pulse duration $\leq 5 \mu sec$; duty factor $\leq 1\%$. ^b For $P_{IN} = 2$ watts. ^c For $P_{IN} = 1$ watt.

2N3229

Silicon N-P-N Planar Transistors

For Large-Signal, High-Power, VHF Applications in Military and Industrial Communications Equipment

Maximum Ratings, Absolute-Maximum Values:

COLLECTOR-TO-BASE VOLTAGE, V_{CB0}	105	volts
COLLECTOR-TO-EMITTER VOLTAGE:		
With base open, V_{CE0}	60	volts
With $V_{BE} = -1.5$ volts, V_{CEV}	105	volts
EMITTER-TO-BASE VOLTAGE, V_{EB0}	4	volts
COLLECTOR CURRENT, I_C	2.5	amperes
TRANSISTOR DISSIPATION, P_T :		
At case temperatures up to 25° C.	17.5	watts
At case temperatures above 25° C.	Derate linearly 100mw/°C	

TEMPERATURE RANGE:		
Storage	-65 to 200	°C
Operating (Junction)	-65 to 200	°C
LEAD TEMPERATURE (During soldering):		
At distances $\geq 1/32"$ from ceramic wafer for 10 sec. max.	230	°C

Features:

- High Power Output, Unneutralized (P_{OUT}):
15 w min. at 50 MHz
5 w min. at 150 MHz
- High Voltage Ratings:
 $V_{CB0} = 105$ volts max.
 $V_{CEV} = 105$ volts max.
 $V_{CE0} = 60$ volts max.
- 100 per cent tested to assure freedom from second breakdown in class-A operation at maximum ratings
- Low Thermal Resistance (θ_{j-c})—
high thermal-conductivity ceramic insulation between collector and mounting stud

Isolated Stud Package:

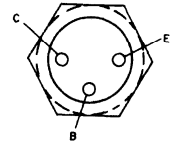
all three electrodes electrically isolated from case—for design flexibility
heavy copper mounting stud—for effective contact with heat sink
pin terminals arranged on a .200" pin-circle diameter—fit commercially available sockets

ELECTRICAL CHARACTERISTICS Case Temperature = 25° C Unless Otherwise Specified

Characteristic	Symbol	TEST CONDITIONS						LIMITS		Units
		DC Collector Volts		DC Base Volts	DC Current (Milliamperes)			Min.	Max.	
		V_{CB}	V_{CE}	V_{BE}	I_E	I_B	I_C			
Collector-Cutoff Current	I_{CB0}	30			0			-	0.1	μA
Collector-to-Base Breakdown Voltage	BV_{CB0}				0	0.5	105	-		volts
Collector-to-Emitter Breakdown Voltage (Sustaining)	$BV_{CE0(sus)}$				0	500*	60	-		volts
Collector-to-Emitter Breakdown Voltage	BV_{CEV}			-1.5		0.1	105	-		volts
Emitter-to-Base Breakdown Voltage	BV_{EB0}				0.1		4	-		volts
Collector-to-Emitter Saturation Voltage	$V_{CE(sat)}$					500	2.5 amp	-	1	volt
Feedback Capacitance (Measured at 140 kHz)	$C_{b'c}$	30			0			-	20	pF
RF Power Output, Unneutralized	P_{out}									
Measured at 50 MHz			50					15 ^a	-	watts
Measured at 150 MHz			50					5 ^b	-	watts
Gain-Bandwidth Product	f_T		28				250	200 (typ.)		MHz
Base-Spreading Resistance (Measured at 400 MHz)	$r_{bb'}$		28				250	6.0 (typ.)		ohms
Collector-to-Case Capacitance	C_c							-	6	pF

* Pulsed. Pulse duration $\leq 5 \mu sec$; duty factor $\leq 1\%$.
^a For $P_{IN} = 2$ watts
^b For $P_{IN} = 1$ watt

TERMINAL DESIGNATIONS



92CS-27481 JEDEC TO-60

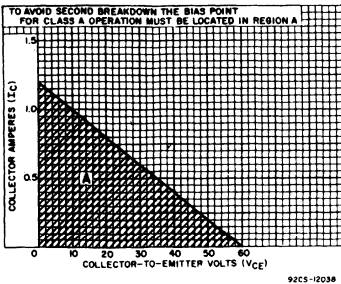


Fig. 1 - Region of safe operation for class A service. For class A operation must be located in region A.

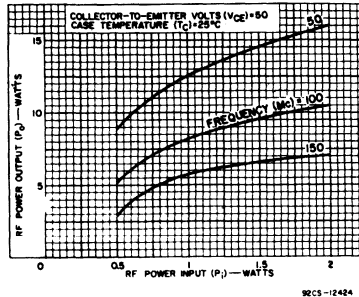


Fig. 2 - Typical operation characteristics.

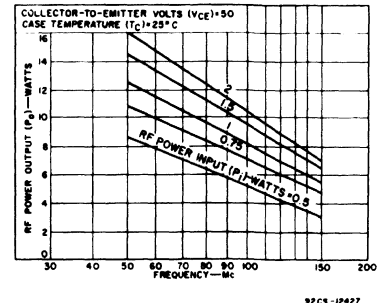


Fig. 3 - Typical operation characteristics.

2N3375, 2N3553, 2N3632

Silicon N-P-N Overlay Transistors

For VHF-UHF Applications

Maximum Ratings, Absolute-Maximum Values:

	2N3553	2N3375	2N3632	2N3553	2N3375	2N3632
COLLECTOR-TO-BASE VOLTAGE V_{CB0}	65	65	65			
COLLECTOR-TO-EMITTER VOLTAGE: With base open V_{CE0}	40	40	40			
With $V_{BE} = -1.5V$ V_{CEV}	65	65	65			
EMITTER-TO-BASE VOLTAGE V_{EBO}	4	4	4			
COLLECTOR CURRENT: Peak	1.0	1.5	3.0			
Continuous I_C	0.33	0.5	1.0			
TRANSISTOR DISSIPATION P_T At case temperature up to 25°C	7.0	11.6	23			
At case temperature above 25°C. Derate linearly to 0 watts at 200°C						

TEMPERATURE RANGE: Storage & Operating (Junction) -65 to 200 °C
 LEAD TEMPERATURE (During soldering): At distances $\geq 1/32$ in. (.793 mm) from insulating wafer (TO-60 package) or from seating plane (TO-39 package) for 10 s max 230 °C

Features:

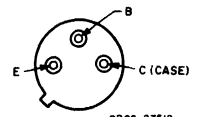
• High Power Output, Class-C Amplifier:

TYPE	400 MHz	260 MHz	175 MHz	100 MHz
2N3632		10 W Typ.	13.5 W Min.	
2N3553		2.5 W Typ.	2.5 W Min.	
2N3375	3 W Min.			7.5 W Min.

• High Power Output, Oscillator: 2.5W (Typ.) at 500 MHz, (2N3375) 1.5W (Typ.) at 500 MHz, (2N3553)

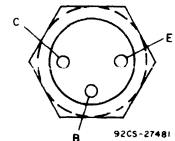
• High Voltage Ratings

TERMINAL DESIGNATIONS



LEAD 1 - EMITTER
 LEAD 2 - BASE
 LEAD 3 - COLLECTOR, CASE

JEDEC TO-39



PIN 1 - EMITTER
 PIN 2 - BASE
 PIN 3 - COLLECTOR
 STUD - NO CONNECTION

2N3632
 2N3375

JEDEC TO-60

All the pins of the 2N3632 and 2N3375 are electrically isolated from the case.

ELECTRICAL CHARACTERISTICS: At Case Temperature (T_C) = 25°C

Characteristic	Symbol	TEST CONDITIONS						LIMITS						Units
		DC Collector Volts		DC Base Volts	DC Current (Milliamperes)			2N3632		2N3553		2N3375		
		V_{CB}	V_{CE}	V_{BE}	I_E	I_B	I_C	Min.	Max.	Min.	Max.	Min.	Max.	
Collector-Cutoff Current	I_{CEO}		30		0			0.25	0.1		0.1		mA	
Collector-to-Base Breakdown Voltage	$V_{(BR)CBO}$				0	0.1			65		65		V	
					0	0.3								
					0	0.5			65					
Collector-to-Emitter Breakdown Voltage	$V_{(BR)CEO}$				0	0 to 200 ^a	40 ^b		40 ^b		40 ^b		V	
	$V_{(BR)CEV}$			-1.5		0 to 200 ^a	65 ^b		65 ^b		65 ^b		V	
Emitter-to-Base Breakdown Voltage	$V_{(BR)EBO}$				0.1	0	4		4		4		V	
					0.25	0								
Collector-to-Emitter Saturation Voltage	$V_{CE(sat)}$				100	500	1		1		1		V	
					50	250								
Collector-to-Base Capacitance Measured at 1 MHz	C_{obo}	30			0		20		10		10		pF	
RF Power Output Amplifier, Unneutralized At 100 MHz	P_{OE}		28				13.5 ^e		2.5 ^g		7.5 ^c		W	
At 175 MHz			28											
At 260 MHz			28				10 ^f (typ.)							
At 400 MHz			28								3 ^d			
Gain-Bandwidth Product	f_T		28			100	400 (typ.)		500 (typ.)		500 (typ.)		MHz	
			28			150								
Base-Spreading Resistance Measured at 100 MHz	r_{bb}		28			100	6.5 (typ.)		12.0 (typ.)				ohms	
At 200 MHz			28			250								
At 400 MHz			28			250				10.0 (typ.)				

^aPulsed through an inductor (25 mH), duty factor = 50%.

^e For $P_{IE} = 3.5$ W; minimum efficiency = 70%.

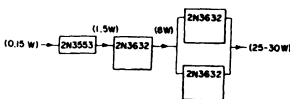
^bMeasured at a current where the breakdown voltage is a minimum.

^f For $P_{IE} = 3.0$ W; typical efficiency = 60%.

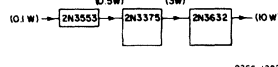
^gFor $P_{IE} = 1/4$ W; minimum efficiency = 50%.

^cFor $P_{IE} = 1.0$ W; minimum efficiency = 65%.

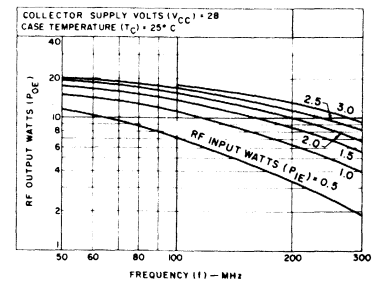
^dFor $P_{IE} = 1.0$ W; minimum efficiency = 40%.



92CS-12826R1



92CS-12827R1



92CS-12829R1

Fig. 1 - Typical 175-MHz amplifier chain for P_{OE} of 25 to 30 watts.

Fig. 2 - Typical 260-MHz amplifier chain for P_{OE} of 10 watts.

Fig. 3 - Power output as a function of frequency for 2N3632.

2N3375, 2N3553, 2N3632

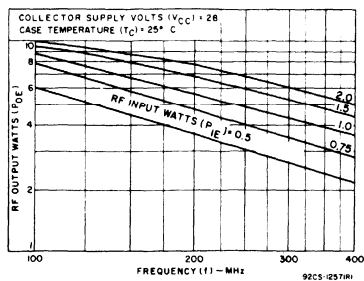


Fig. 4 - Power output as a function of frequency for 2N3375.

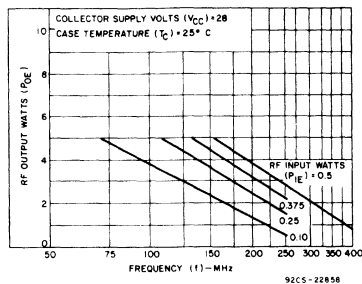


Fig. 5 - Power output as a function of frequency for type 2N3553.

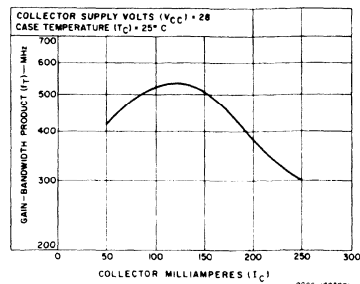


Fig. 6 - Gain-bandwidth product as a function of collector current for types 2N3632.

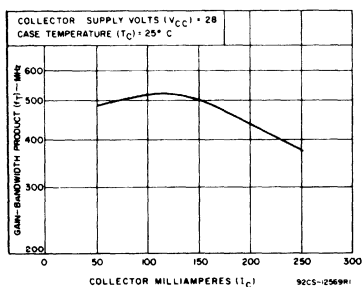


Fig. 7 - Gain-bandwidth product as a function of collector current for types 2N3375.

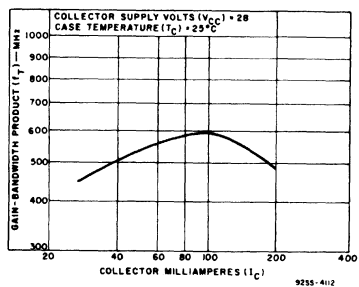


Fig. 8 - Gain-bandwidth product as a function of collector current for 2N3553.

2N3478

Silicon N-P-N Epitaxial Planar Transistor

For VHF/UHF Applications in Industrial and Commercial Equipment

Features:

- high gain-bandwidth product - $f_T = 900\text{ MHz typ.}$
- low noise figure
 $NF = 5\text{ dB typ. at } 470\text{ MHz}$
 $4.5\text{ dB max. at } 200\text{ MHz}$
 $2.5\text{ dB typ. at } 60\text{ MHz}$
- high unneutralized power gain
 $G_{pu} = 11.5\text{ dB min. at } 200\text{ MHz}$
- hermetically sealed four-lead package
- all active elements insulated from case
- low collector-to-base feedback capacitance, $C_{cb} = 0.7\text{ pF max.}$

Maximum Ratings, Absolute-Maximum Values:

Collector-to-Base Voltage, V_{CBO}	30	V
Collector-to-Emitter Voltage, V_{CEO}	15	V
Emitter-to-Base Voltage, V_{EBO}	2	V
Collector Current, I_C	limited by dissipation	
Transistor Dissipation, PT:		
at ambient	} up to 25°C	200
temperatures above 25°C		

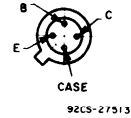
Temperature Range:

Storage and Operating (Junction)	-65 to 200	°C
----------------------------------	------------	----

Lead Temperature (During Soldering):

At distances not closer than 1/32" to seating surface for 10 seconds max.	265	°C
---	-----	----

TERMINAL DESIGNATIONS



JEDEC TO-72

ELECTRICAL CHARACTERISTICS, At an Ambient Temperature (T_A) of 25°C

Characteristics	Symbols	TEST CONDITIONS					LIMITS			Units
		Frequency f MHz	DC Collector-to-Base Voltage V_{CB} V	DC Collector-to-Emitter Voltage V_{CE} V	DC Emitter Current I_E mA	DC Collector Current I_C mA	Type 2N3478			
							Min.	Typ.	Max.	
Collector-Cutoff Current	I_{CBO}		1		0		-	-	0.02	μA
Collector-to-Base Breakdown Voltage	BV_{CBO}				0	0.001	30	-	-	V
Collector-to-Emitter Breakdown Voltage	BV_{CEO}					0.001	15	-	-	V
Emitter-to-Base Breakdown Voltage	BV_{EBO}				-0.001	0	2	-	-	V
Static Forward-Current Transfer Ratio	h_{FF}			8		2	25	-	150	
Magnitude of Small-Signal Forward-Current Transfer Ratio	h_{fe}^a	100		8		2	7.5	9	16	
Collector-to-Base Feedback Capacitance	C_{cb}^b	1	10		0		-	-	1	pF
Small-Signal, Common-Emitter Power Gain in Unneutralized Amplifier Circuit	G_{pe}^a	200		8		2	11.5	-	17	dB
Small-Signal, Common-Emitter Power Gain in Neutralized Amplifier Circuit	C_{pe}^a, c	470		6		1.5	-	12	-	dB
VHF Noise Figure	NF^a, c	470		6		1.5	-	5	-	dB
VHF Noise Figure	NF^a	200		8		2	-	-	4.5	dB
	NF^b, d		60		8					

^a Fourth lead (case) grounded.

^b C_{cb} is a three terminal measurement of the collector-to-base capacitance with the emitter and case connected to the guard terminal.

^c Source Resistance, $R_s = 50\text{ ohms.}$

^d Source Resistance, $R_s = 400\text{ ohms.}$

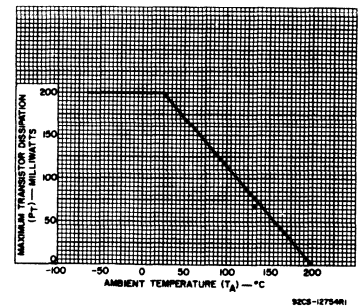


Fig. 1 - Rating chart for type 2N3478

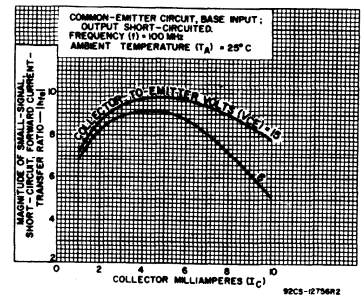


Fig. 2 - Typical small-signal beta characteristics for type 2N3478

2N3600 SILICON N-P-N EPITAXIAL PLANAR TRANSISTORS

For VHF Applications In Military, Communications, and Industrial Equipment

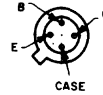
MAXIMUM RATINGS, Absolute-Maximum Values:

	2N3600	
COLLECTOR-TO-BASE VOLTAGE, V_{CBO}	30	V
COLLECTOR-TO-EMITTER VOLTAGE, V_{CEO}	15	V
EMITTER-TO-BASE VOLTAGE, V_{EBO}	3	V
COLLECTOR CURRENT, I_C	*	mA
TRANSISTOR DISSIPATION, P_T :		
For operation with heat sink:		
At case temperatures* $\left\{ \begin{array}{l} \text{up to } 25^\circ\text{C} \\ \text{above } 25^\circ\text{C} \end{array} \right.$	300	mW
	Derate at 1.71 mW/ $^\circ\text{C}$	
For operation at ambient temperatures:		
At ambient temperatures $\left\{ \begin{array}{l} \text{up to } 25^\circ\text{C} \\ \text{above } 25^\circ\text{C} \end{array} \right.$	200	mW
	Derate at 1.14 mW/ $^\circ\text{C}$	
TEMPERATURE RANGE:		
Storage and Operating (Junction)	-65 to +200	$^\circ\text{C}$
LEAD TEMPERATURE (During Soldering):		
At distances $\geq 1/16$ inch from seating surface for 60 seconds max.	300	$^\circ\text{C}$

Features:

- high gain-bandwidth product
 - hermetically sealed four-lead package
 - low leakage current
 - high 200-MHz power gain
- 2N3600
- low noise figure
NF = 4.5 dB max. at 200 MHz
 - low collector-to-base time constant
 $r_b' C_c = 15$ ps max.
 - high power gain as neutralized amplifier
 $G_{pe} = 17$ dB min. at 200 MHz

TERMINAL DESIGNATIONS



JEDEC TO-72

92CS-2751.3

* Limited by transistor dissipation. ** Measured at center of seating surface.

ELECTRICAL CHARACTERISTICS

Characteristics	Symbols	TEST CONDITIONS								LIMITS			Units
		Ambient Temperature	Frequency	DC Collector-to-Base Voltage	DC Collector-to-Emitter Voltage	DC Emitter-to-Base Voltage	DC Emitter Current	DC Collector Current	DC Base Current	Type 2N3600			
		T_A $^\circ\text{C}$	f MHz	V_{CB} V	V_{CE} V	V_{EB} V	I_E mA	I_C mA	I_B mA	Min.	Typ.	Max.	
Collector-Cutoff Current	I_{CBO}	25 150		15 15			0 0			- -	- 1	0.01 1	μA μA
Collector-to-Base Breakdown Voltage	BV_{CBO}	25					0	0.001		30	-	-	V
Collector-to-Emitter Sustaining Voltage	$BV_{CEO(sus)}$	25						3	0	15	-	-	V
Emitter-to-Base Breakdown Voltage	BV_{EBO}	25					0.01	0		3	-	-	V
Collector-to-Emitter Saturation Voltage	$V_{CE(sat)}$	25						10	1	-	-	0.4	V
Base-to-Emitter Saturation Voltage	$V_{BE(sat)}$	25						10	1	-	-	1	V
Static Forward Current-Transfer Ratio	h_{FE}	25			1			3		20	-	150	
Small-Signal Forward Current-Transfer Ratio ^a	h_{fe}	25	100 1 kHz		6 6			5 2		8.5 40	-	15 200	
Common-Base Output Capacitance ^b	C_{ob}	25	0.1 to 1	0			0			-	-	-	pF
Collector-to-Base Feedback Capacitance ^b	C_{cb}	25	0.1 to 1	10			0			-	-	1	pF
Common-Base Input Capacitance ^c	C_{ib}	25	0.1 to 1			0.5	0			-	1.4	-	pF
Collector-to-Base Time Constant ^a	$r_b' C_c$	25	31.9	6				5		4	-	15	ps
Small-Signal Power Gain in Neutralized Common-Emitter Amplifier Circuit ^a	G_{pe}	25	200		6			5		17	-	24	dB
Power Output in Common-Emitter Oscillator Circuit ^a (See Fig.5)	P_o	25	≥ 500	10			12			20	-	-	mW
Noise Figure ^a	NF	25	200		6			1.5		-	-	4.5	dB
Noise Figure ^{a,d}	NF	25	60		6			1		-	-	3	dB

^a Lead No.4 (case) grounded.

^b Three-terminal measurement of the collector-to-base capacitance with the case and emitter leads connected to the guard terminal.

^c Lead No.4 (case) floating.

^d Generator Resistance (R_g) = 400 ohms.

2N3733

10-W, 400-MHz Silicon N-P-N Overlay Transistor

For Large-Signal, High-Power VHF/UHF Applications

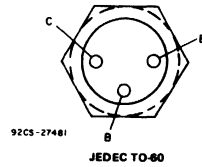
MAXIMUM RATINGS, Absolute-Maximum Values:

*COLLECTOR-TO-BASE VOLTAGE	V _{CB0}	65	V
COLLECTOR-TO-EMITTER VOLTAGE:			
With base-emitter junction reverse-biased (V _{BE} = -1.5 V)	V _{CEV}	65	V
*With base open	V _{CEO}	40	V
*EMITTER-TO-BASE VOLTAGE	V _{EBQ}	4	V
*COLLECTOR CURRENT:			
Continuous	I _C	1	A
Peak		3	A
*CONTINUOUS BASE CURRENT	I _B	1	A
*TRANSISTOR DISSIPATION:	P _T		
At case temperatures up to 25°C		23	W
At case temperatures above 25°C		Derate linearly to 0 watts at 200°C	
*TEMPERATURE RANGE:			
Storage and operating (junction)		-65 to 200	°C
*LEAD TEMPERATURE (During soldering):			
At distances ≥ 1/32 in. (0.8 mm) from insulating wafer for 10 s max...		230	°C

Features:

- High power output, unneutralized Class C amplifier:
 - at 400 MHz 10 W min.
 - at 280 MHz 14.5 W typ.
- High voltage ratings:
 - V_{CB0} = 65 V max.
 - V_{CEV} = 65 V max.
 - V_{CEO} = 40 V max.
- 100 per cent tested to assure freedom from second breakdown for operation in Class A applications
- Low thermal resistance

TERMINAL DESIGNATIONS



ELECTRICAL CHARACTERISTICS, At Case Temperature (T_C) = 25°C unless otherwise specified

CHARACTERISTIC	SYMBOL	TEST CONDITIONS						LIMITS		UNITS
		VOLTAGE V dc			CURRENT mA dc			MIN.	MAX.	
		V _{CB}	V _{CE}	V _{BE}	I _E	I _B	I _C			
Collector Cutoff Current:										
With base open	I _{CEO}		30			0		-	0.25	mA
With base-emitter junction reverse-biased	I _{CEV}		65	-1.5				-	5	
At T _C = 200°C			30	-1.5				-	10	
With emitter open	I _{CBO}	65						-	0.5	
Emitter Cutoff Current	I _{EBO}			-4				-	0.25	mA
Collector-to-Base Breakdown Voltage	V _{(BR)CBO}					0	0.5	65	-	V
Collector-to-Emitter Breakdown Voltage:										
With base-emitter junction reverse-biased	V _{(BR)CEV}			-1.5			0 to 200*	65**	-	V
Emitter-to-Base Breakdown Voltage	V _{(BR)EBO}				0.25		0	4	-	V
Collector-to-Emitter Sustaining Voltage:										
With base open	V _{CEO(sus)}					0	200	40	-	V
With external base-emitter resistance (R _{BE}) = 100 Ω	V _{CER(sus)}						200	40	-	
DC Forward Current Transfer Ratio	h _{FE}		5				1	5	-	
			5				0.25	10	150	
Collector-to-Emitter Saturation Voltage	V _{CE(sat)}					200	1000	-	1	V
Base-Emitter Voltage	V _{BE}			5			1000	-	1.5	V
Magnitude of Common-Emitter, Small-Signal, Short-Circuit Forward Current Transfer Ratio (f = 100 MHz)	h _{fe}		28				250	2.5*	-	
			28				250	4.0 (typ.)	-	
Collector-to-Base Capacitance (f = 0.1 to 1 MHz)	C _{ob}	28					250	-	25	pF
Available Amplifier Signal Input Power: P _i = 10 W, Z _G = 50 Ω, f = 400 MHz	P _i							-	4	W
Collector Circuit Efficiency: P _o = 10 W, Z _G = 50 Ω, f = 400 MHz	η _C							45	-	%
Base Spreading Resistance Measured at 200 MHz	r _{bb}		28				250	6.5 (typ.)	-	Ω
Collector-to-Case Capacitance	C _s							-	6	pF
Thermal Resistance (Junction-to-Case)	R _{θJC}							-	7.5	°C/W

* Pulsed through an inductor (25 mH); duty factor = 50%
 ** Measured at a current where the breakdown voltage is a minimum

* In accordance with JEDEC registration data

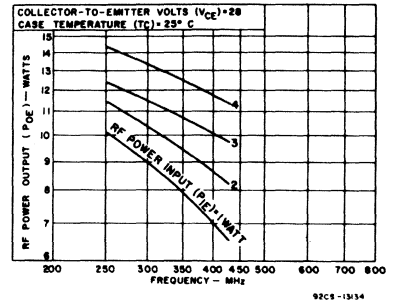


Fig. 1 - Power output as a function of frequency.

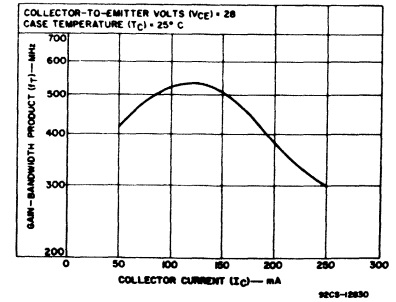


Fig. 2 - Gain-bandwidth product as a function of collector current.

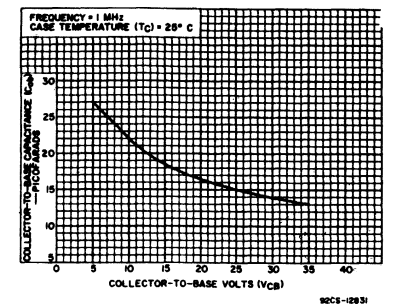


Fig. 3 - Variation of collector-to-base capacitance.

2N3839 SILICON N-P-N EPITAXIAL PLANAR TRANSISTOR

For Low-Noise UHF Applications in Industrial and Military Equipment

Maximum Ratings, Absolute-Maximum Values:

COLLECTOR-TO-BASE VOLTAGE, V_{CBO}	30	V
COLLECTOR-TO-EMITTER VOLTAGE, V_{CEO}	15	V
EMITTER-TO-BASE VOLTAGE, V_{EBO}	2.5	V
COLLECTOR CURRENT, I_C	40	mA
TRANSISTOR DISSIPATION, P_T :		

For operation with heat sink:
 At case temperatures ** $\left\{ \begin{array}{l} \text{up to } 25^\circ\text{C} \dots\dots\dots 300 \text{ mW} \\ \text{above } 25^\circ\text{C} \dots\dots\dots \text{Derate at } 1.72 \text{ mW}/^\circ\text{C} \end{array} \right.$

For operation at ambient temperatures:
 At ambient temperatures $\left\{ \begin{array}{l} \text{up to } 25^\circ\text{C} \dots\dots\dots 200 \text{ mW} \\ \text{above } 25^\circ\text{C} \dots\dots\dots \text{Derate at } 1.14 \text{ mW}/^\circ\text{C} \end{array} \right.$

TEMPERATURE RANGE:

Storage and Operating (Junction) -65 to +200 °C

LEAD TEMPERATURE (During Soldering):

At distances $\geq 1/32$ inch from seating surface for 10 seconds max. 265 °C

Features:

- very low device noise figure —
 $NF = 3.4 \text{ dB max. as } 450\text{-MHz amplifier}$
- high gain-bandwidth product —
 $f_T = 1000 \text{ MHz min.}$
- high converter (450-to-30 MHz) gain —
 $G_C = 15 \text{ dB typ. for circuit bandwidth of approximately } 2 \text{ MHz}$
- high power gain as neutralized amplifier —
 $G_{pe} = 12.5 \text{ dB min. at } 450 \text{ MHz for circuit bandwidth of } 20 \text{ MHz}$
- high power output as UHF oscillator —
 $P_O = 30 \text{ mW min., } 40 \text{ mW typ. at } 500 \text{ MHz}$
 $= 20 \text{ mW typ. at } 1 \text{ GHz}$
- low collector-to-base time constant —
 $t_b, C_c = 7 \text{ ps typ.}$
- low collector-to-base feedback capacitance —
 $C_{cb} = 0.6 \text{ pF typ.}$

TERMINAL DESIGNATIONS



CASE
92CS-27513

JEDEC TO-72

ELECTRICAL CHARACTERISTICS

CHARACTERISTICS	SYMBOL	TEST CONDITIONS							LIMITS			UNITS
		FREQUENCY	DC COLLECTOR-TO-BASE VOLTAGE V_{CB}	DC COLLECTOR-TO-EMITTER VOLTAGE V_{CE}	DC EMITTER-TO-BASE VOLTAGE V_{EB}	DC EMITTER CURRENT I_E	DC BASE CURRENT I_B	DC COLLECTOR CURRENT I_C	TYPE 2N3839			
		f MHz	V	V	V	mA	mA	mA	Min.	Typ.	Max.	
Collector-Cutoff Current $T_A = 25^\circ\text{C}$ $T_A = 150^\circ\text{C}$	I_{CBO}		15 15			0 0			- -	- -	10 1.0	nA μA
Collector-to-Base Breakdown Voltage	BV_{CBO}					0		0.001	30	-	-	V
Collector-to-Emitter Breakdown Voltage	BV_{CEO}						0	3	15	-	-	V
Emitter-to-Base Breakdown Voltage	BV_{EBO}					0.01		0	2.5	-	-	V
Static Forward Current-Transfer Ratio	h_{FE}			1				3	30	-	150	
Small-Signal Forward Current-Transfer Ratio	h_{fe}	0.001 ^c 100 ^c		6 6				2 5	50 10	-	220 20	
Collector-to-Base Feedback Capacitance	C_{cb}	0.1 to 1.0 ^b	10			0			-	0.6	1.0	pF
Input Capacitance	C_{ib}	0.1 to 1.0			0.5			0	-	1.4	-	pF
Collector-to-Base Time Constant	t_b, C_c	31.9 ^e	6			-2			1	7	15	ps
Small-Signal, Common-Emitter Power Gain in Neutralized Amplifier Circuit	G_{pe}	450 ^c		6				1.5	12.5	-	19	dB
Power Output as Oscillator	P_O	$\geq 500^a$	10			-12			30	-	-	mW
UHF Measured Noise Figure	NF	450 ^{c,d}		6				1.5	-	-	3.9	dB
UHF Device Noise Figure	NF	450 ^{c,d,f}		6				1.5	-	-	3.4	dB
VHF Measured Noise Figure	NF	600 ^{c,e}		6				1	-	2	-	dB

^a Lead No.4 (case) not connected.
^b 3-terminal measurement with emitter and case connected to guard terminal.
^c Lead No.4 (case) grounded.
^d Generator resistance, $R_g = 50$ ohms.
^e Generator resistance, $R_g = 400$ ohms.
^f Device noise figure is approximately 0.5 dB lower than the measured noise figure. The difference is due to the insertion loss at the input of the test circuit (0.25 dB) and the contribution of the following stages in the test setup (0.25 dB).

2N3866

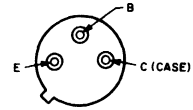
Silicon N-P-N Overlay Transistor

High-Gain Driver for VHF/UHF Applications in Military and Industrial Communications Equipment

Features

- High Power Gain, Unneutralized Class C Amplifier
 - 1 W output at 400 MHz (10 dB gain)
 - 1 W output at 250 MHz (15 dB gain)
 - 1 W output at 175 MHz (17 dB gain)
 - 1 W output at 100 MHz (20 dB gain)
- Low Output Capacitance
 - C_{obo} = 3 pF max.

TERMINAL DESIGNATIONS



92CS-27512

JEDEC TO-39

MAXIMUM RATINGS, Absolute-Maximum Values:

COLLECTOR-TO-BASE VOLTAGE ... V _{CBO}	55	V	CONTINUOUS BASE CURRENT ... I _B	0.4	A
COLLECTOR-TO-EMITTER VOLTAGE:			TRANSISTOR DISSIPATION ... P _T	5	W
With external base-to-emitter resistance (R _{BE}) = 10Ω ... V _{CER}	55	V	At case temperature up to 25°C		
With base open ... V _{CEO}	30	V	At case temperatures above 25°C	See Fig. 2	
EMITTER-TO-BASE VOLTAGE ... V _{EBO}	3.5	V	TEMPERATURE RANGE:		
CONTINUOUS COLLECTOR CURRENT ... I _C	0.4	A	Storage & Operating (Junction) ...	-65 to +200	°C
			LEAD TEMPERATURE		
			At distances ≥ 1/16 in. (1.58 mm) from seating plane for 10 s max. ...	230	°C

ELECTRICAL CHARACTERISTICS, At Case Temperature (T_C) = 25°C

STATIC

CHARACTERISTIC	SYMBOL	TEST CONDITIONS					LIMITS		UNITS
		DC Voltage (V)		DC Current (mA)			Min.	Max.	
		V _{CE}	V _{EB}	I _E	I _B	I _C			
Collector-Cutoff Current:									
Base-emitter junction reverse biased	I _{CEX}	55	1.5				-	0.1	mA
T _C = 200°C		30	1.5				-	0.1	
Base open	∇I _{CEO}	28		0			-	20	μA
Collector-to-Base Breakdown Voltage	V _{(BR)CBO}			0	0.1		55	-	V
Collector-to-Emitter Breakdown Voltage:									
With base open	V _{(BR)CEO}			0	5		30	-	V
With base connected to emitter through 10-ohm resistor	V _{(BR)CER}		0		5		55	-	V
Emitter-to-Base Breakdown Voltage	V _{(BR)EBO}			0.1	0		3.5	-	V
Emitter-Cutoff Current	I _{EBO}		3.5				-	0.1	mA
Collector-to-Emitter Saturation Voltage	V _{CE(sat)}			20	100		-	1.0	V
DC Forward-Current Transfer Ratio	h _{FE}	5			360		5	-	
		5			50		10	200	
Thermal Resistance: (Junction-to-Case)	θ _{J-C}						-	35	°C/W

DYNAMIC

TEST & CONDITIONS	SYMBOL	FREQUENCY MHz	LIMITS		UNITS
			MINIMUM	MAXIMUM	
Power Output (V _{CC} = 28 V): P _I E = 0.1 W	POE	400	1.0	-	W
Large-Signal Common-Emitter Power Gain (V _{CC} = 28 V): P _I E = 0.1 W	GPE	400	10	-	dB
Collector Efficiency (V _{CC} = 28 V): P _I E = 0.1 W, P _O E = 1 W, Source Impedance = 50Ω	η _C	400	45	-	%
Magnitude of Common-Emitter, Small Signal, Short-Circuit Forward-Current Transfer Ratio: I _C = 50 mA, V _{CE} = 15 V	h _{fe}	200	2.5	-	
Available Amplifier Signal Input Power, P _O E = 1 W, Source Impedance = 50Ω	P _i	400		0.1	W
Common-Base Output Capacitance (V _{CB} = 28 V)	C _{obo}	1		3	pF

* In accordance with JEDEC registration data format JS-6 RDF-3

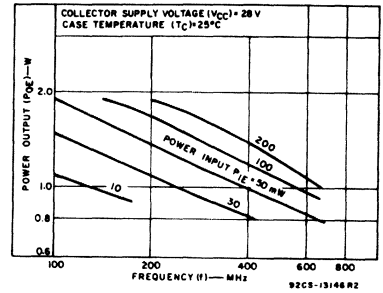


Fig. 1 - Power output as a function of frequency.

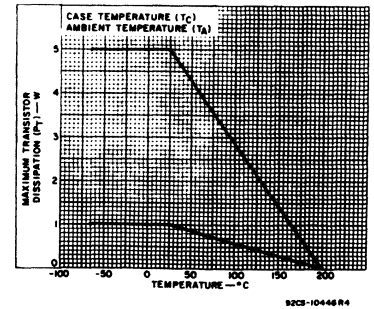


Fig. 2 - Dissipation derating curve.

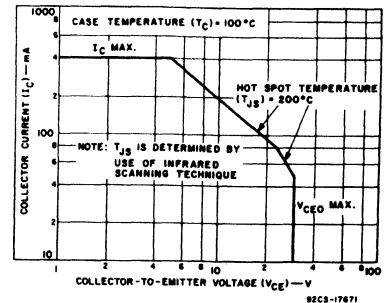


Fig. 3 - Safe area for dc operation.

2N4012 High-Power Silicon N-P-N Overlay Transistor

For Applications as a Frequency Multiplier
Into the UHF or L-Band Range

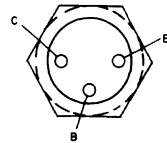
MAXIMUM RATINGS, Absolute-Maximum Values:

COLLECTOR-TO-EMITTER VOLTAGE:			
With base open	V _{CEO}	40	V
With V _{BE} = -1.5 volts	V _{CEV}	65	V
COLLECTOR-TO-BASE VOLTAGE	V _{CBO}	65	V
EMITTER-TO-BASE VOLTAGE	V _{EBO}	4	V
COLLECTOR CURRENT	I _C	1.5	A

TRANSISTOR DISSIPATION:

At case temperatures up to 25°C	P _T	11.6	W
At case temperatures above 25°C		See Fig. 5	
TEMPERATURE RANGE:			
Storage & Operating (Junction)		-65 to +200	°C
LEAD TEMPERATURE (During soldering):			
At distances ≥ 1/32 in. (0.8 mm) from insulating water for 10 s max.		230	°C

TERMINAL DESIGNATIONS



92CS-27481

JEDEC TO-80

Features.

- 2.5 W output with 4 dB conversion gain (min.) as tripler to 1 GHz
- 3 W output with 4.8 dB conversion gain (typ.) as doubler to 800 MHz
- High voltage ratings
- Freedom from second breakdown

ELECTRICAL CHARACTERISTICS, Case Temperature = 25°C

CHARACTERISTIC	SYMBOL	TEST CONDITIONS						LIMITS		UNITS
		DC Collector Volts		DC Base Volts	DC Current (Milliamperes)			Min.	Max.	
		V _{CB}	V _{CE}	V _{BE}	I _E	I _B	I _C			
Collector-Cutoff Current	I _{CEO}		30		0			—	0.1	mA
Collector-to-Base Breakdown Voltage	BV _{CBO}				0		0.1	65	—	volts
Collector-to-Emitter Breakdown Voltage	BV _{CEO}					0	0 to 200 ^a	40 ^b	—	volts
	BV _{CEV}			-1.5			0 to 200 ^a	65 ^b	—	volts
Emitter-to-Base Breakdown Voltage	BV _{EBO}				0.1		0	4	—	volts
Collector-to-Emitter Saturation Voltage	V _{CE(sat)}					100	500	—	1	volt
Collector-to-Base Capacitance	C _{ob}	30			0			—	10	pF
RF Power Output	P _{OUT}							2.5 ^c		watts
Tripler At 1002 Mc/s								3.0 ^d (typ.)		
Doubler At 800 Mc/s								500 (typ.)		Mc/s
Gain-Bandwidth Product	f _T						150			Mc/s
Collector-to-Base Cutoff Frequency ^e	f _c						0	25 (typ.)		Gc/s

- a Pulsed through an inductor (25 mH); duty factor = 50%.
- b Measured at a current where the breakdown voltage is a minimum.
- c For P_{IN} = 1.0 W; at 334 Mc/s; minimum collector efficiency = 25%.
- d For P_{IN} = 1.0 W; at 400 Mc/s; typical collector efficiency = 35%.
- e Cutoff frequency is determined from Q measurement at 210 Mc/s. The cutoff frequency of the collector-to-base junction of the transistor, f_c = Q × 210 Mc/s.

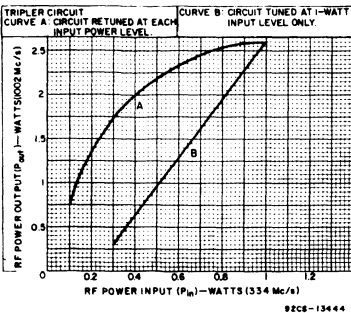


Fig. 3 - Power output as a function of power input.

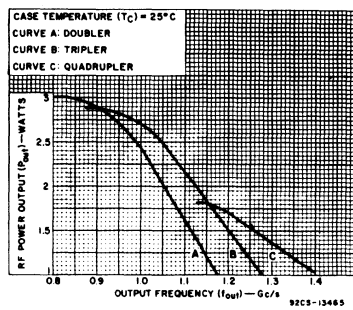


Fig. 4 - Power output as a function of collector supply voltage

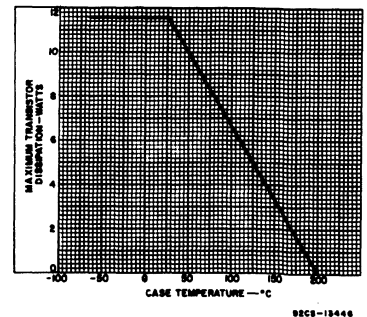


Fig. 5 - Dissipation derating curve.

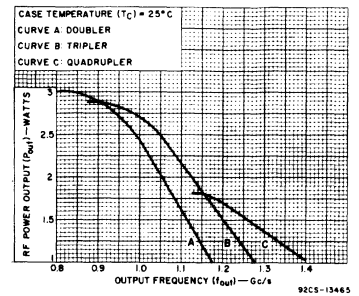


Fig. 1 - Output power as a function of output frequency.

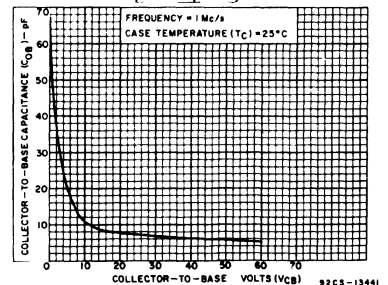


Fig. 2 - Collector-to-base capacitance as a function of collector-to-base voltage.

2N4427

Silicon N-P-N Overlay Transistor

High-Gain Driver for VHF-UHF

MAXIMUM RATINGS, Absolute-Maximum Values:

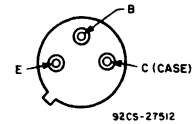
* COLLECTOR-TO-BASE VOLTAGE	V _{CB0}	40	V
* COLLECTOR-TO-EMITTER VOLTAGE: With base open	V _{CEO}	20	V
* EMITTER-TO-BASE VOLTAGE	V _{EBO}	2	V
* CONTINUOUS COLLECTOR CURRENT	I _C	0.4	A
* CONTINUOUS BASE CURRENT	I _B	0.4	A
* TRANSISTOR DISSIPATION: At case temperatures up to 100°C	P _T	2	W
* TEMPERATURE RANGE: Storage & Operating (Junction)		-65 to 200	°C
* LEAD TEMPERATURE (During soldering): At distances ≥ 1/32 in. (0.8 mm) from insulating wafer for 10 s max.		230	°C

* In accordance with JEDEC registration data format JS-6 RDF-3.

Features:

- 1 W output with 10 dB gain (min.) at 175 MHz
V_{CC} = 12 V
- 0.4 W output with 5 dB gain (typ.) at 470 MHz
V_{CC} = 12 V

TERMINAL DESIGNATIONS



JEDEC TO-39

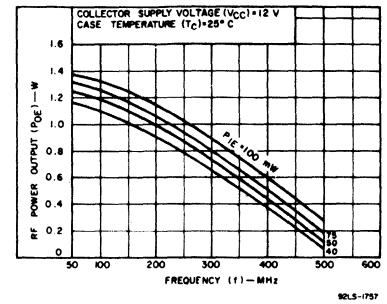


Fig. 1 - Power output as a function of frequency.

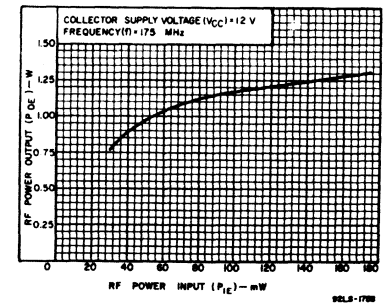


Fig. 2 - Power output as a function of power input at 175 MHz.

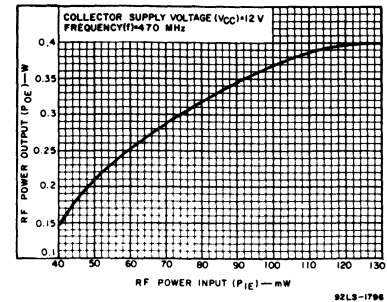


Fig. 3 - Power output as a function of power input at 470 MHz.

ELECTRICAL CHARACTERISTICS, At Case Temperature (T_C) = 25°C.

Characteristic	Symbol	TEST CONDITIONS						Limits		Units
		DC Voltage (V)				DC Current (mA)		Min.	Max.	
		V _{BE}	V _{EB}	V _{CB}	V _{CE}	I _E	I _B			
Collector-Cutoff Current: With base open	I _{CEO}				12	0		—	0.02	mA
With base-emitter junction reverse-biased	I _{CEV}	-1.5			40			—	0.1	
T _C = 150°C	I _{CEV}	-1.5			12			—	5	
Emitter-Cutoff Current	I _{EBO}		2					—	0.1	mA
Collector-to-Base Breakdown Voltage	V _{(BR)CBO}					0	0.1	40	—	V
Collector-to-Emitter Sustaining Voltage: With base open	V _{CEO(sus)}					0	5	20	—	V
With external base-to-emitter resistance (R _{BE}) = 10Ω	V _{CER(sus)}						5	40	—	
Emitter-to-Base Breakdown Voltage	V _{(BR)EBO}					0.1	0	2	—	V
Collector-to-Emitter Saturation Voltage	V _{CE(sat)}					20	100	—	0.5	V
DC Forward Current Transfer Ratio	h _{FE}				5	360	5	—		
					5	100	10	200		
Magnitude of Common-Emitter Small-Signal, Short-Circuit Forward Current Transfer Ratio (f = 200 MHz)	h _{fe}				15		50	2.5	—	
Collector-to-Base Capacitance (f = 1 MHz)	C _{ob}			12		0		—	4	pF
RF Power Output Class C Amplifier, Unneutralized (f = 175 MHz, P _I = 0.1 W, η _C ≥ 50%)	P _O			12 (V _{CC})				1	—	W
Available Amplifier Signal Input Power (f = 175 MHz, P _O = 1 W, Z _{IN} = 50 Ω)	P _i			12 (V _{CC})				—	0.1	W
Collector Efficiency (f = 175 MHz, P _O = 1 W, Z _{IN} = 50 Ω)	η _C			12 (V _{CC})				50	—	%
Thermal Resistance Junction-to-Case	R _{θJC}							—	50	°C/W

* In accordance with JEDEC registration data format JS-6 RDF-3.

2N4440

Silicon N-P-N Overlay Transistor

For Class A, B, or C VHF/UHF
Military and Industrial Communications Equipment

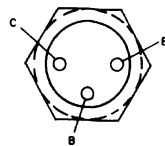
Features:

- 5 W output min. at 400 MHz
- 6.5 W output typ. at 225 MHz

MAXIMUM RATINGS, Absolute-Maximum Values:

*COLLECTOR-TO-BASE VOLTAGE	V_{CBO}	65	V
*COLLECTOR-TO-EMITTER VOLTAGE:			
With base-emitter junction reverse-biased ($V_{BE} = -1.5$ V)	V_{CEV}	65	V
With base open	V_{CEO}	40	V
*EMITTER-TO-BASE VOLTAGE	V_{EBO}	4	V
*CONTINUOUS COLLECTOR CURRENT	I_C	1.5	A
*CONTINUOUS BASE CURRENT	I_B	0.2	A
*TRANSISTOR DISSIPATION ^A :	P_T		
At case temperatures up to 25°C		11.6	W
At case temperatures above 25°C		See Fig. 2	
*TEMPERATURE RANGE:			
Storage and operating (junction)		-65 to 200	°C
LEAD TEMPERATURE (During soldering):			
At distances $\geq 1/32$ in. (0.8 mm) from insulating wafer for 10 s max		230	°C

TERMINAL DESIGNATIONS



92CS-27481

JEDEC TO-60

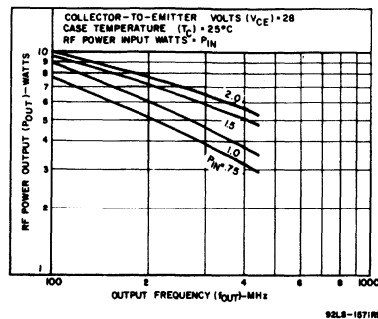


Fig. 1 - Typical power output as a function of frequency.

ELECTRICAL CHARACTERISTICS, At Case Temperature (T_C) = 25°C unless otherwise specified

CHARACTERISTIC	SYMBOL	TEST CONDITIONS						LIMITS		UNITS	
		VOLTAGE V dc			CURRENT mA dc			MIN.	MAX.		
		V_{CB}	V_{CE}	V_{BE}	I_E	I_B	I_C				
Collector Cutoff Current: With base open	I_{CEO}		30			0		-	0.1	mA	
With base-emitter junction reverse-biased	I_{CEV}		65	-1.5				-	1		
At $T_C = 200^\circ\text{C}$	I_{CEV}		30	-1.5				-	5		
Emitter Cutoff Current	I_{EBO}				-4			-	0.1	mA	
Collector-to-Base Breakdown Voltage	$V_{(BR)CBO}$					0	0.1	65	-	V	
Collector-to-Emitter Breakdown Voltage: With base-emitter junction reverse-biased	$V_{(BR)CEV}$				-1.5		0 to 200*	65**	-	V	
Emitter-to-Base Breakdown Voltage	$V_{(BR)EBO}$					0.1	0	4	-	V	
Collector-to-Emitter Sustaining Voltage: With base open	$V_{CE0(sus)}$					0	200*	40	-	V	
With external base-to-emitter resistance ($R_{BE} = 100\Omega$)	$V_{CER(sus)}$						200*	40	-		
DC Forward Current Transfer Ratio	h_{FE}		5				1360 125	3 10	- 200		
Collector-to-Emitter Saturation Voltage	$V_{CE(sat)}$						50	250	-	1	V
Magnitude of Common-Emitter, Small-Signal, Short-Circuit Forward Current Transfer Ratio ($f = 100$ MHz)	$ h_{fe} $		28					125	4* 5 (typ.)	-	
Collector-to-Base Capacitance ($f = 1$ MHz)	C_{ob}		28					125	-	12	pF
Available Amplifier Signal Input Power ($P_O = 5$ W, $Z_G = 50\Omega$, $f = 400$ MHz)	P_i								-	1.7	W
Collector Circuit Efficiency ($P_O = 5$ W, $Z_G = 50\Omega$, $f = 400$ MHz)	η_C								45	-	%
Base Spreading Resistance Measured at 200 MHz	$r_{bb'}$		28					250	10 (typ.)	-	Ω
Collector-to-Case Capacitance	C_s								-	6	pF
Thermal Resistance (Junction-to-Case)	$R_{\theta JC}$								-	15	°C/W

* Pulsed through an inductor (25 mH), duty factor=50%

** Measured at a current where the breakdown voltage is a minimum

* In accordance with JEDEC registration data

^ASecondary breakdown considerations limit maximum dc operating conditions. . . contact your RCA Representative for specific data.

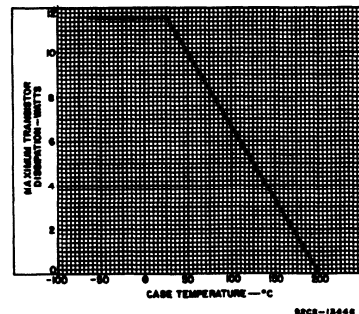


Fig. 2 - Dissipation derating chart.

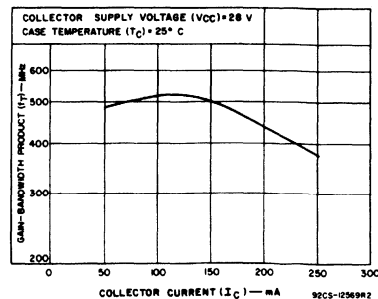


Fig. 3 - Typical gain-bandwidth product as a function of collector current.

2N4932, 2N4933

Silicon N-P-N Overlay Transistors

For International VHF Mobile and Portable Communication, 66 to 88 MHz

Features:

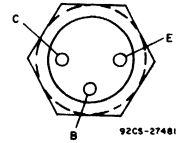
- Operation From a Power Supply of -
 - 13.5 volts (2N4932)
 - 24 volts (2N4933)
- Power Output (Min.) at 88 MHz:
 - 12 watts (2N4932)
 - 20 watts (2N4933)
- Load Protection
- High Voltage Ratings

RATINGS

Maximum Ratings, Absolute-Maximum Values:

	2N4932	2N4933		2N4932	2N4933
COLLECTOR-TO-BASE VOLTAGE	50	70	RF INPUT POWER	P_{in}	
VOLTAGE			At 88 MHz		3.5 W
COLLECTOR-TO-EMITTER VOLTAGE	V_{CBO}		TRANSISTOR DISSIPATION	P_T	
VOLTAGE:			At case temperatures up to 25°C		70 W
With base open	V_{CEO}	25	TEMPERATURE RANGE:		
With $V_{BE} = -1.5V$	V_{CEV}	50	Storage & Operating (Junction)		-65 to 200 °C
EMITTER-TO-BASE VOLTAGE	V_{EBO}	4.0	LEAD TEMPERATURE (During soldering):		
COLLECTOR CURRENT:			At distances $\geq 1/32$ in. from insulating wafer for 10 s max.		230 °C
Peak		10			
Continuous	I_C	3.3			

TERMINAL DESIGNATIONS



JEDEC TO-60

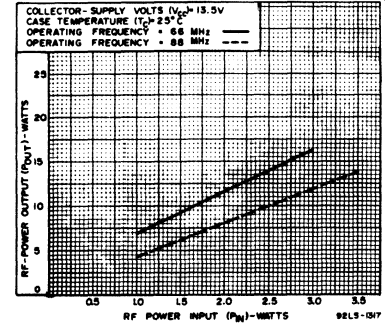


Fig. 1 - Typical power output as a function of power input for the 2N4932.

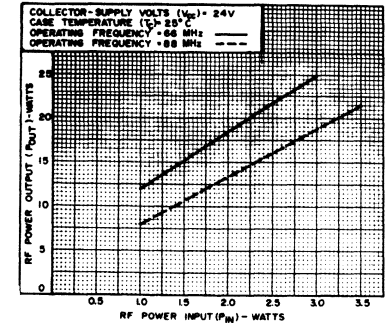


Fig. 2 - Typical power output as a function of power input for the 2N4933.

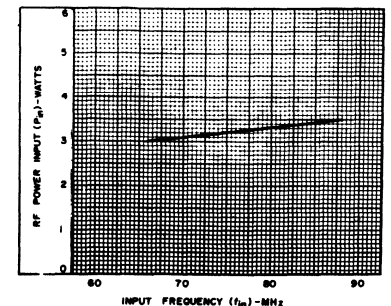


Fig. 3 - Input derating curve.

ELECTRICAL CHARACTERISTICS FOR 2N4932

Case Temperature = 25°C

Characteristic	Symbol	TEST CONDITIONS						Limits		Units
		DC Collector Volts		DC Base Volts	DC Current (Milliamperes)			Min.	Max.	
		V_{CB}	V_{CE}	V_{BE}	I_E	I_B	I_C			
Collector-Cutoff Current	I_{CEO}		15			0			1.0	mA
	I_{CBO}	40				0			10	mA
Collector-to-Emitter Breakdown Voltage	$V_{CEV}^{(sus)}$			-1.5			200 ^a	50		V
	$V_{CEO}^{(sus)}$						0	200 ^a	25	V
Emitter-to-Base Breakdown Voltage	BV_{EBO}				10		0	4		V
Collector-to-Base Capacitance	C_{ob}	15				0			120	pF
RF Power Output	P_{out}								12 ^b	W

ELECTRICAL CHARACTERISTICS FOR 2N4933

Case Temperature = 25°C

Characteristic	Symbol	TEST CONDITIONS						Limits		Units
		DC Collector Volts		DC Base Volts	DC Current (Milliamperes)			Min.	Max.	
		V_{CB}	V_{CE}	V_{BE}	I_E	I_B	I_C			
Collector-Cutoff Current	I_{CEO}		30			0			1.0	mA
	I_{CBO}	50				0			10	mA
Collector-to-Emitter Breakdown Voltage	$V_{CEV}^{(sus)}$			-1.5			200 ^a	70		V
	$V_{CEO}^{(sus)}$						0	200 ^a	35	V
Emitter-to-Base Breakdown Voltage	BV_{EBO}				10		0	4		V
Collector-to-Base Capacitance	C_{ob}	30				0			85	pF
RF Power Output	P_{out}								20 ^b	W

^aPulsed through an inductor (25mH), duty factor = 50%

^bFor $P_{in} = 3.5$ W, at 88 MHz; $V_{CC} = 24$ V, minimum efficiency = 70%

^cFor $P_{in} = 3.5$ W, at 66 MHz; $V_{CC} = 13.5$ V, minimum efficiency = 70%

2N5070 Silicon N-P-N Overlay Transistor

For High-Frequency Single-Sideband Communications Equipment

MAXIMUM RATINGS, Absolute-Maximum Values:

*COLLECTOR-TO-BASE VOLTAGE	V _{CB0}	65	V
COLLECTOR-TO-EMITTER VOLTAGE:			
With base-emitter junction reverse-biased (V _{BE}) = -1.5 V	V _{CEV}	65	V
With external base-to-emitter resistance (R _{BE}) = 5Ω	V _{CER}	40	V
* With base open	V _{CEO}	30	V
*EMITTER-TO-BASE VOLTAGE	V _{EBO}	4	V
*COLLECTOR CURRENT:	I _C		
Continuous		3.3	A
Peak		10	A
*CONTINUOUS BASE CURRENT	I _B	1	A
*TRANSISTOR DISSIPATION:	P _T		
At case temperatures up to 25°C		70	W
At case temperatures above 25°C		See Fig. 2	
*TEMPERATURE RANGE:			
Storage and operating (junction)		-65 to 200	°C
*LEAD TEMPERATURE (During soldering):			
At distances ≥ 1/32 in. (0.8 mm) from insulating wafer for 10 s max.		230	°C

*In accordance with JEDEC registration data

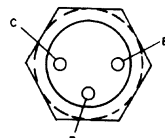
ELECTRICAL CHARACTERISTICS, At Case Temperature (T_C) = 25° C unless otherwise specified

CHARACTERISTIC	SYMBOL	TEST CONDITIONS					LIMITS		UNITS	
		VOLTAGE V dc			CURRENT mA dc		MIN.	MAX.		
		V _{CB}	V _{CE}	V _{BE}	I _E	I _B				I _C
Collector Cutoff Current: With base-emitter junction reverse-biased	I _{CEV}	60	-1.5					-	10	mA
At T _C = 150° C		60	-1.5					-	10	
With emitter open		I _{CB0}	60		0				-	
With base open	I _{CEO}	30			0			-	5	
Emitter Cutoff Current	I _{EBO}			4				-	10	mA
Collector-to-Emitter Sustaining Voltage: With base-emitter junction reverse-biased	V _{CEV(sus)}			-1.5			200*	65	-	V
With base open	V _{CEO(sus)}				0	200*	30	-		
With external base-to-emitter resistance (R _{BE}) = 5Ω	V _{CER(sus)}					200*	40	-		
Emitter-to-Base Breakdown Voltage	V(BR)EBO				10			4	-	V
DC Forward Current Transfer Ratio	h _{FE}	5	5			3000	10	100		
Magnitude of Common-Emitter Small-Signal Short-Circuit Forward Current Transfer Ratio (f = 50 MHz)	h _{fe}	15				1000	2	-		
Output Capacitance (f = 1 MHz)	C _{ob}	30			0		-	85		pF
Available Amplifier Signal Input Power Z _G = 50Ω, P _o = 25 W(PEP) f ₁ = 30 MHz, f ₂ = 30.001 MHz	P _i								1.25 PEP	W
Intermodulation Distortion Z _G = 50Ω, P _o = 25 W(PEP) f ₁ = 30 MHz, f ₂ = 30.001 MHz	IMD								30	dB
Collector Efficiency Z _G = 50Ω, P _o = 25 W(PEP) f ₁ = 30 MHz, f ₂ = 30.001 MHz	η _C								40	%
Thermal Resistance Junction-to-Case	R _{θJC}								2.5	°C/W

Features:

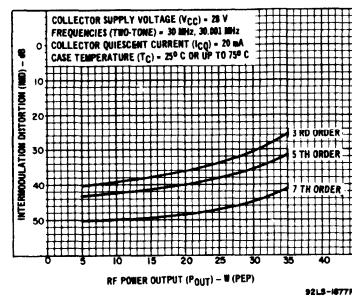
- Suitable for class A or class B amplifiers
- 25 W PEP output min. at 30 MHz with gain: 13 dB
η: 40% min.,
IMD: 30 dB max.
- Low thermal resistance

TERMINAL DESIGNATIONS



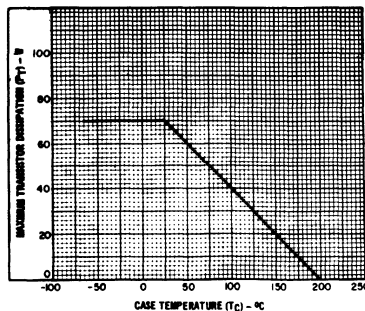
92CS-27481

JEDEC TO-60



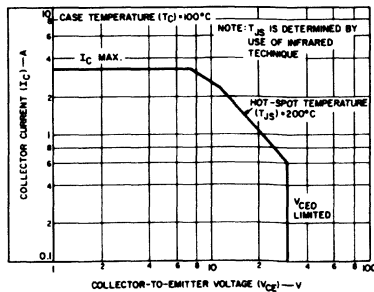
92LS-1077R1

Fig. 1 - Typical intermodulation distortion as a function of rf power output.



92LS-1082R2

Fig. 2 - Dissipation derating chart.



92CS-1930

Fig. 3 - Safe operation with dc forward bias.

*In accordance with JEDEC registration data format
*Pulsed through a 25-mH inductor; duty factor = 50%

2N5071

24-W(CW), 76-MHz Emitter-Ballasted Overlay Transistor

Silicon N-P-N Device for 24-Volt Applications in VHF Communications Equipment

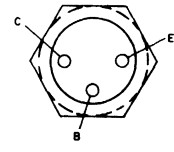
MAXIMUM RATINGS, Absolute-Maximum Values:

*COLLECTOR-TO-BASE VOLTAGE	V_{CBO}	65	V
*COLLECTOR-TO-EMITTER VOLTAGE	V_{CEO}	30	V
*EMITTER-TO-BASE VOLTAGE	V_{EBO}	4	V
*COLLECTOR CURRENT:			
Continuous	I_C	3.3	A
Peak		10	A
*CONTINUOUS BASE CURRENT	I_B	1	A
*TRANSISTOR DISSIPATION:	P_T		
At case temperatures up to 25°C		70	W
*TEMPERATURE RANGE:			
Storage and operating (junction)		-65 to 200	°C
*LEAD TEMPERATURE (During soldering):			
At distances $\geq 1/32$ in. (0.8 mm) from insulating wafer for 10 s max.		230	°C

Features:

- For class B or class C amplifiers
- For 24-V FM (30 to 76 MHz) communications
- 24 W output at 76 MHz with 9 dB gain (Min.)
- Low thermal resistance

TERMINAL DESIGNATIONS



92CS-27481

JEDEC TO-80

ELECTRICAL CHARACTERISTICS, At Case Temperature (T_C) = 25°C

STATIC

CHARACTERISTIC	SYMBOL	TEST CONDITIONS						LIMITS		UNITS
		DC Collector Voltage-V		DC Base Voltage-V		DC Current mA		MIN.	MAX.	
		V_{CB}	V_{CE}	V_{BE}	I_E	I_B	I_C			
Collector-Cutoff Current:										
At $T_C = 150^\circ\text{C}$	I_{CEV}		60	-1.5				-	10	mA
With base open	I_{CEO}		30	-1.5		0		-	10	
With emitter open	I_{CBO}	60						-	10	
Emitter Cutoff Current	I_{EBO}				4			-	10	mA
Collector-to-Base Breakdown Voltage	$V_{(BR)CBO}$				0		200 ^a	65	-	V
Collector-to-Emitter Breakdown Voltage:					0		200 ^a	30	-	V
With base open	$V_{(BR)CEO}$									
Collector-to-Emitter Sustaining Voltage:					0		200 ^a	30	-	V
With base open	$V_{CEO(sus)}$									
With external base-to-emitter resistance ($R_{BE} = 5 \Omega$)	$V_{CER(sus)}$						200 ^a	40	-	
Emitter-to-Base Breakdown Voltage	$V_{(BR)EBO}$				10	0		4	-	V
DC Forward Current Transfer Ratio	h_{FE}		5				3 A	10	100	
			5				1 A	20	-	
Thermal Resistance (Junction-to-Case)	$R_{\theta JC}$							-	2.5	°C/W

^aPulsed through a 25-mH inductor; duty factor = 50%; repetition rate ≥ 60 Hz

DYNAMIC

CHARACTERISTIC	SYMBOL	TEST CONDITIONS				LIMITS		UNITS
		DC Collector Supply (V_{CC})-V	Input Power (P_{IE})-W	Frequency (f)-MHz		MIN.	MAX.	
Power Output	P_{OE}	24	3	76	24	-	W	
Power Gain	G_{PE}	24	3	76	9	-	dB	
Magnitude of Common-Emitter, Small-Signal, Short-Circuit Forward Current Transfer Ratio	$ h_{fe} $	$V_{CE} = 15\text{ V}$ $I_C = 1\text{ A}$		50	2	-		
Available Amplifier Signal Input Power	P_i	Source impedance (Z_g) = 50	$P_{OE} = 24\text{ W}$	76	-	3	W	
Collector Efficiency	η_C	24	3	76	60	-	%	
Load Mismatch	LM	24	1.2	30	GO/NO GO	VSWR = 3.1		
Collector-to-Base Capacitance	C_{obo}	$V_{CB} = 30\text{ V}$		1	-	85	pF	

^aIn accordance with JEDEC registration data

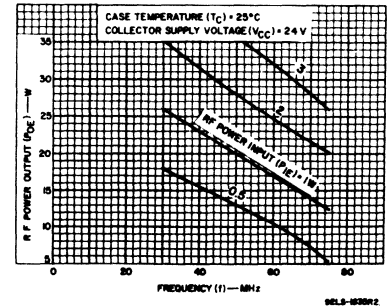


Fig. 1 - Typical output power as a function of frequency.

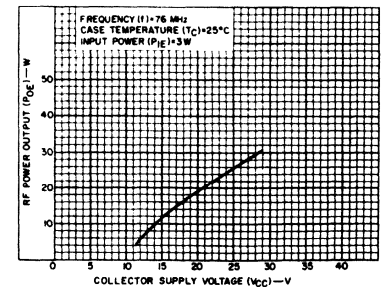


Fig. 2 - Typical output power as a function of collector supply voltage.

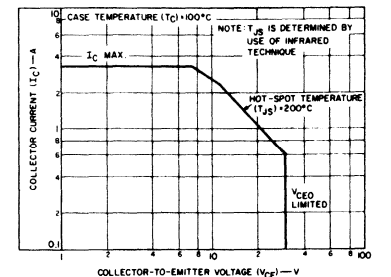


Fig. 3 - Safe area for dc operation.

2N5090

High-Power Silicon N-P-N Overlay Transistor

High-Gain Type for Class A, B, or C Operation in VHF/UHF Circuits

MAXIMUM RATINGS, Absolute-Maximum Values:

*COLLECTOR-TO-BASE VOLTAGE ... V _{CB0}	55	V	*CONTINUOUS BASE CURRENT ... I _B	0.4	A
COLLECTOR-TO-EMITTER VOLTAGE:			*TRANSISTOR DISSIPATION ... P _T		
With external base-to-emitter resistance, R _{BE} = 10Ω ... V _{CEr}	55	V	At case temperatures up to 100°C ...	4	W
*With base open ... V _{CEO}	30	V	At case temperatures above 100°C ... Derate linearly at 0.04 W/°C		
*EMITTER-TO-BASE VOLTAGE ... V _{EB0}	3.5	V	*TEMPERATURE RANGE		-65 to +200 °C
*CONTINUOUS COLLECTOR CURRENT ... I _C	0.4	A	*LEAD TEMPERATURE (during soldering):		
			At distances ≥ 1/16 in. (1.58 mm) from insulating wafer for 10 s max. ...	230	°C

ELECTRICAL CHARACTERISTICS, At Case Temperature (T_C) = 25°C
STATIC

CHARACTERISTIC	SYMBOL	TEST CONDITIONS					LIMITS		UNITS
		DC Collector Voltage-V	DC Base Voltage-V	I _E	I _B	I _C	MIN.	MAX.	
		V _{CE}	V _{BE}	I _E	I _B	I _C			
Collector-Cutoff Current:									
With base open	I _{CEO}	28		0			0.02		mA
With base-emitter junction reverse-biased		55	-1.5				0.1		
With base-emitter junction reverse-biased & T _C = 200°C	I _{CEV}	30	-1.5				5		
Emitter-Cutoff Current	I _{EBO}		3.5				0.1		mA
Collector-to-Base Breakdown Voltage	V _{(BR)CBO}			0	0.1	55			V
Collector-to-Emitter Sustaining Voltage:									
With base open	V _{CEO(sus)}			0	5	30			V
With external base-to-emitter resistance (R _{BE}) = 10Ω	V _{CEr(sus)}			5	55*				
Emitter-to-Base Breakdown Voltage	V _{(BR)EBO}			0.1	0	3.5			V
Collector-to-Emitter Saturation Voltage	V _{CE(sat)}			20	100		1.0		V
DC Forward Current Transfer Ratio	h _{FE}	5			360	5			
		5			50	10	200		
Thermal Resistance (Junction-to-Case)	R _{θJC}						25		°C/W

*Pulsed through a 25-mH inductor, duty factor = 0.05%.

DYNAMIC

CHARACTERISTIC	SYMBOL	TEST CONDITIONS					LIMITS		UNITS
		DC Collector Voltage V	Output Power (P _{OE}) W	Input Power (P _I) W	Collector Current (I _C) mA	Frequency (f) MHz	MIN.	MAX.	
Power Output (Class C amplifier, unneutralized)	P _{OE}	V _{CC} = 28		0.2		400	1.2		W
Gain-Bandwidth Product	f _T	V _{CE} = 15			50		500		MHz
Magnitude of Common Emitter, Small-Signal, Short-Circuit Forward-Current Transfer Ratio	h _{fe}	V _{CE} = 15			50		2.5		
Available Amplifier Signal Input Power	P _i		1.2			400		0.2	W
Collector Efficiency	η _C		1.2				45		%
Collector-to-Base Capacitance	C _{obo}	V _{CB} = 30				1		3.5	pF

*In accordance with JEDEC registration data format JS-6 RDF-3.

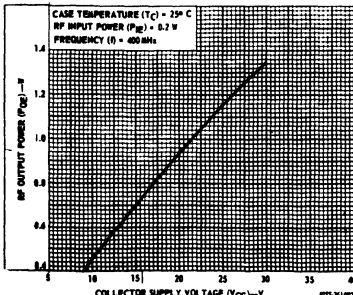


Fig. 3 - Typical output power as a function of collector supply voltage.

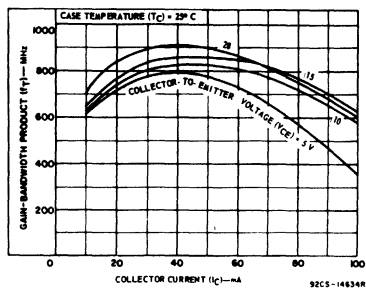
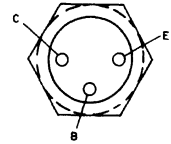


Fig. 4 - Typical gain-bandwidth product as a function of collector current.

Features:

- Maximum safe-area-of-operation curve
- 1.2 W (min.) output at 400 MHz (7.8 dB gain)
- 1.6 W (typ.) output at 175 MHz (12 dB gain)
- Hermetic stud-type package
- All electrodes isolated from stud

TERMINAL DESIGNATIONS



92CS-27481
JEDEC TO-60

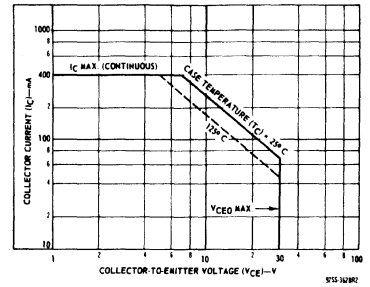


Fig. 1 - Safe area for dc operation.

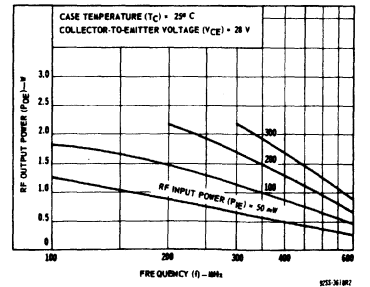


Fig. 2 - Typical output power as a function of frequency.

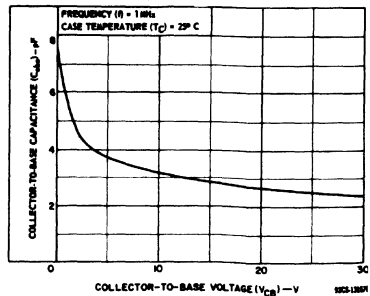


Fig. 5 - Typical variation of collector-to-base capacitance with collector-to-base voltage.

Silicon N-P-N Overlay Transistor

High-Power Device for Class-C, AM Operation in VHF Circuits

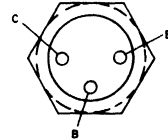
Features:

- 15 Watts Output Min. at 136 MHz
- For 24-Volt Aircraft Communication
- Complete Load Mismatch Protection
- High Voltage Ratings
- Case Connected to Emitter

Maximum Ratings, Absolute-Maximum Values:

COLLECTOR-TO-EMITTER VOLTAGE:		With V_{BE}^* = 1.5 volts	V_{CEV}	100	V	TRANSISTOR DISSIPATION	P_T	At case temperatures up to 25° C	70	W
EMITTER-TO-BASE VOLTAGE:		With external base-to-emitter resistance $R_{BE} = 5 \Omega$	V_{CER}	50	V	TEMPERATURE RANGE:		Storage & Operating (Junction)	-65 to 200	°C
COLLECTOR CURRENT:		Peak	I_C	10	A	LEAD TEMPERATURE (During soldering):		At distance $\geq 1/32$ in. from insulating wafer for 10 s max	230	°C
		Continuous	I_C	3.3	A					

TERMINAL DESIGNATIONS



92CA-37481
JEDEC TO-60

ELECTRICAL CHARACTERISTICS, At Case Temperature (T_C) = 25°C unless otherwise specified

CHARACTERISTIC	SYMBOL	TEST CONDITIONS						LIMITS		UNITS	
		VOLTAGE V dc			CURRENT mA dc			MIN.	MAX.		
		V_{CB}	V_{CE}	V_{BE}	I_E	I_B	I_C				
Collector Cutoff Current: With base-emitter junction reverse biased At $T_C = 150^\circ\text{C}$	I_{CEV}		83	-1.5				-	20	mA	
With external base-to-emitter resistance (R_{BE}) = 5 Ω	I_{CER}		50					-	10	mA	
Emitter Cutoff Current	I_{EBO}			-4				-	10	mA	
Collector-to-Emitter Sustaining Voltage: With base-emitter junction reverse biased	$V_{CEV(sus)}$			-1.5			600 ^a	100	-	V	
With external base-to-emitter resistance (R_{BE}) = 5 Ω	$V_{CER(sus)}$						200 ^a	50	-	V	
With base open	$V_{CEO(sus)}$						0	200 ^a	35	-	V
Emitter-to-Base Breakdown Voltage	$V_{(BR)EBO}$				10	0	4	-	100	V	
DC Forward Current Transfer Ratio	h_{FE}		4				3 A	10	-		
			4				0.5 A	10	100		
Magnitude of Common-Emitter, Small-Signal, Short-Circuit Forward Current Transfer Ratio (f = 150 MHz)	$ h_{fe} $		24				500	1	-		
Output Capacitance (f = 1 MHz)	C_{ob}	30			0			-	85	pF	
Available Amplifier Signal Input Power ^b ($P_O = 15$ W, $Z_G = 50 \Omega$, f = 136 MHz)	P_i							-	6	W	
Collector Circuit Efficiency ($P_{IE} = 6$ W, $Z_G = 50 \Omega$, f = 136 MHz)	η_C							70	-	%	
Modulation (f = 118 MHz)	M		24 (VCC)					80	-	%	
Load Mismatch (f = 118 MHz)	LM		24 (VCC)				1100	Will not be damaged			
Dynamic Input Impedance ($P_{IE} = 6$ W, f = 150 MHz)	Z_{IN}		24 (VCC)					1.7 + j 2.6 (typ)		Ω	
Thermal Resistance (Junction to Case)	$R_{\theta JC}$							-	2.5	°C/W	

* In accordance with JEDEC registration data.
^a Pulsed through a 9-mH inductor; duty factor = 50%.
^b Unmodulated carrier.

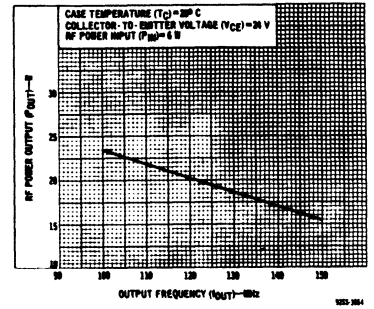


Fig. 1 - Typical power output as a function of frequency.

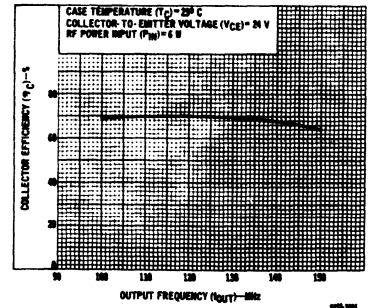


Fig. 2 - Typical collector efficiency as a function of output frequency.

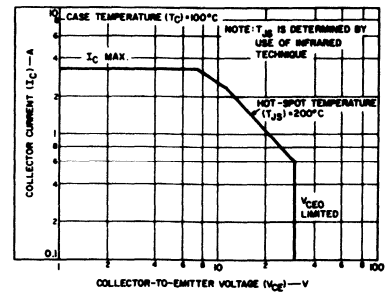


Fig. 3 - Safe operation area with dc forward bias.

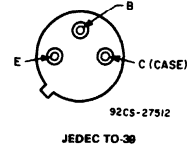
2N5109

Silicon N-P-N Overlay Transistor

High Gain for Line Amplifiers in CATV and MATV Equipment

- Features:
- High gain-bandwidth product
 - Large dynamic range
 - Low distortion
 - Low noise

TERMINAL DESIGNATION



MAXIMUM RATINGS, Absolute-Maximum Values:

COLLECTOR-TO-BASE VOLTAGE	V_{CBO}	40	V	TRANSISTOR DISSIPATION:	P_T	2.5	W
COLLECTOR-TO-EMITTER VOLTAGE:				At case temperature up to 75°C			
With base open	V_{CEO}	20	V	TEMPERATURE RANGE:		-65	+200
With external base-to-emitter resistance (R_{BE}) = 10 Ω	V_{CER}	40	V	Storage and operating (Junction)			
EMITTER-TO-BASE VOLTAGE	V_{EBO}	3	V	LEAD TEMPERATURE (During Soldering):			
CONTINUOUS COLLECTOR CURRENT	I_C	0.4	A	At distances \geq 1/32 in. (0.8 mm) from the seating plane for 10 s max		230	°C
CONTINUOUS BASE CURRENT	I_B	0.4	A				

ELECTRICAL CHARACTERISTICS, Case Temperature (T_C) = 25°C

CHARACTERISTIC	SYMBOL	TEST CONDITIONS						LIMITS	UNITS		
		DC COLLECTOR OR BASE VOLTAGE - V				DC CURRENT (mA)				MIN. MAX.	
		V_{CB}	V_{BE}	V_{CE}	V_{EB}	I_E	I_B				
Collector-Cutoff Current: With base open	I_{CEO}			15		0		-	20	μ A	
With base-emitter junction reverse-biased	I_{CEV}		-1.5	35				-	5	mA	
$T_C = 150^\circ\text{C}$			-1.5	15				-	5	mA	
Emitter-Cutoff Current	I_{EBO}				3			-	0.1	mA	
Collector-to-Base Breakdown Voltage	$V_{(BR)CBO}$					0	0.1	40	-	V	
Collector-to-Emitter Sustaining Voltage: With external base-to-emitter resistance (R_{BE}) = 10 Ω	$V_{CER(sus)^a}$							5	40	-	V
With base open	$V_{CEO(sus)}$						0	5	20	-	V
Emitter-to-Base Breakdown Voltage	$V_{(BR)EBO}$					0.1		0	3	-	V
Collector-to-Emitter Saturation Voltage	$V_{CE(sat)}$						10	100	-	0.5	V
Collector-to-Base Capacitance ($f = 1$ MHz)	C_{cb}	15				0		-	3.5	-	pF
DC Forward-Current Transfer Ratio	h_{FE}			15			50	40	120	-	
				5			360	5	-	-	
Small-Signal Common-Emitter Forward Current Transfer Ratio ($f = 200$ MHz)	h_{fe}			15			25	4.8	-	-	
				15			50	6	-	-	
				15			100	4.8	-	-	
Magnitude of Common-Emitter Small-Signal Forward Current Transfer Ratio ($f = 200$ MHz)	$ h_{fe} $			15			50	6	-	-	
Available Amplifier Signal Input Power ($P_{out} = 1.26$ mW, Source Impedance = 50 Ω , $f = 200$ MHz)	P_i	15	(V_{CC})				50	-	0.1	-	mW
Voltage Gain, Wideband, 50 to 216 MHz	G_{VE}			15			50	11	-	-	dB
Cross Modulation @ 54 dBmV ^b Output	CM			15			50	-57	(typ.)	-	dB
Power Gain, Narrowband ($f = 200$ MHz, $P_{IN} = -10$ dBm)	G_{PE}			15			10	11	-	-	dB
Noise Figure ($f = 200$ MHz)	NF			15			10	3	(typ.)	-	dB

^a Pulsed through a 25 mH inductor; duty factor = 50%

^b 0 dBmV = 1 millivolt

^c In accordance with JEDEC registration data

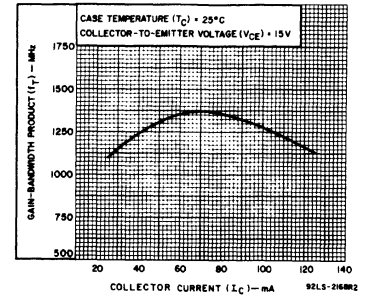


Fig. 1 - Gain-bandwidth product as a function of collector current.

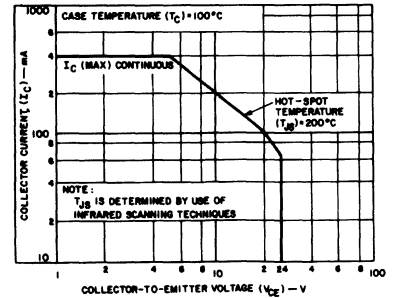


Fig. 2 - Maximum operating area.

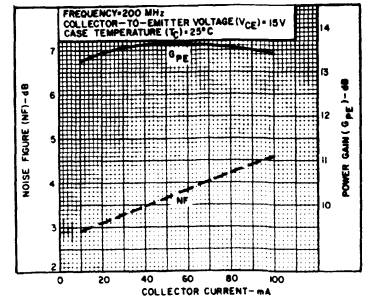


Fig. 3 - Power gain and noise figure as a function of collector current.

2N5179

SILICON N-P-N EPITAXIAL PLANAR TRANSISTOR

For UHF Applications in Military, Communications, and Industrial Equipment

Maximum Ratings, Absolute-Maximum Values:

COLLECTOR-TO-BASE VOLTAGE, V_{CBO}	20	V	
COLLECTOR-TO-EMITTER VOLTAGE, V_{CEO}	12	V	For operation at ambient temperatures: At ambient temperatures { up to 25°C : 200 mW { above 25°C : Derate at 1.14mW/°C
EMITTER-TO-BASE VOLTAGE, V_{EBO}	2.5	V	
COLLECTOR CURRENT, I_C	50	mA	TEMPERATURE RANGE: Storage and Operating (Junction) -65 to +200 °C
TRANSISTOR DISSIPATION, P_T			LEAD TEMPERATURE (During Soldering): At distances $\geq 1/32"$ from seating surface for 10 seconds max. 265 °C
For operation with heat sink:			
At case temperatures** { up to 25°C : 300 mW { above 25°C : Derate at 1.71mW/°C			

** Measured at center of seating surface.

Features:

- high gain-bandwidth product — 1000MHz min.
- hermetically sealed TO-72 four-lead metal package
- low leakage current
- high power gain as neutralized amplifier — $G_{ps} = 15dB$ min. at 200MHz
- high power output as UHF oscillator — 20mW typ. at 500MHz
- low noise figure — $NF = 4.5dB$ max. at 200MHz
- low collector-to-base time constant — $r_b C_c = 14ps$ max.
- high reliability — production lots of RCA-2N5179 are subjected to and meet the minimum mechanical, environmental, and life-test requirements of the basic MILITARY specification MIL-S-19500. See Fig.2 for a description of the Group A and Group B Tests.

TERMINAL DESIGNATIONS



92CS-27513

JEDEC TO-72

ELECTRICAL CHARACTERISTICS

Characteristics	Symbols	TEST CONDITIONS									LIMITS			Units	
		Ambient Temp. T_A	Frequency f	DC Collector-to-Base Voltage V_{CB}	DC Collector-to-Emitter Voltage V_{CE}	DC Emitter-to-Base Voltage V_{EB}	DC Emitter Current I_E	DC Collector Current I_C	DC Base Current I_B	Type 2N5179					
		°C	MHz	V	V	V	mA	mA	mA	Min.	Typ.	Max.			
Collector-Cutoff Current	I_{CBO}	25 150		15 15			0 0							0.02 1	μA μA
Collector-to-Base Breakdown Voltage	$V_{(BR)CBO}$	25					0	0.001				20			V
Collector-to-Emitter Sustaining Voltage	$V_{CEO(sus)}$	25						3	0			12			V
Emitter-to-Base Breakdown Voltage	$V_{(BR)EBO}$	25					-0.01	0				2.5			V
Collector-to-Emitter Saturation Voltage	$V_{CE(sat)}$	25							10	1				0.4	V
Base-to-Emitter Saturation Voltage	$V_{BE(sat)}$	25							10	1				1	V
Static Forward Current-Transfer Ratio	h_{FE}	25			1				3			25	70	250	
Magnitude of Small-Signal Forward Current-Transfer Ratio ^a	$ h_{fe} $	25	100 1 kHz		6 6				5 2			9 25	14 90	20 300	
Collector-to-Base Feedback Capacitance ^b	C_{cb}	25	0.1 to 1	10					0					0.7	pF
Common-Base Input Capacitance ^c	C_{cb}	25	0.1 to 1			0.5			0					2	pF
Collector-to-Base Time Constant	$r_b C_c$	25	31.9	6					2			3	7	14	ps
Small-Signal Power Gain in Neutralized Common-Emitter Circuits	G_{ps}	25	200		12				5			15	21		dB
Power Output in Common-Emitter Oscillator Circuit	P_o	25	>500	10					-12			20			mW
Noise Figure ^a	NF	25	200		6				1.5				3	4.5	dB

^a Lead No. 4(case) grounded; $R_g = 125\Omega$
^b Three-terminal measurement of the collector-to-base capacitance with the case and emitter leads connected to the guard terminal.

^c Lead No. 4 (case) floating.

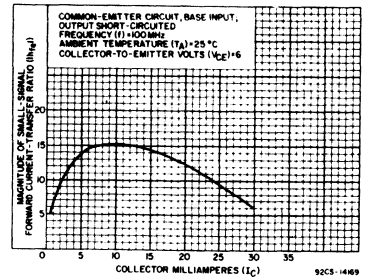


Fig. 1—Small-signal beta characteristics for type 2N5179.

2N5179

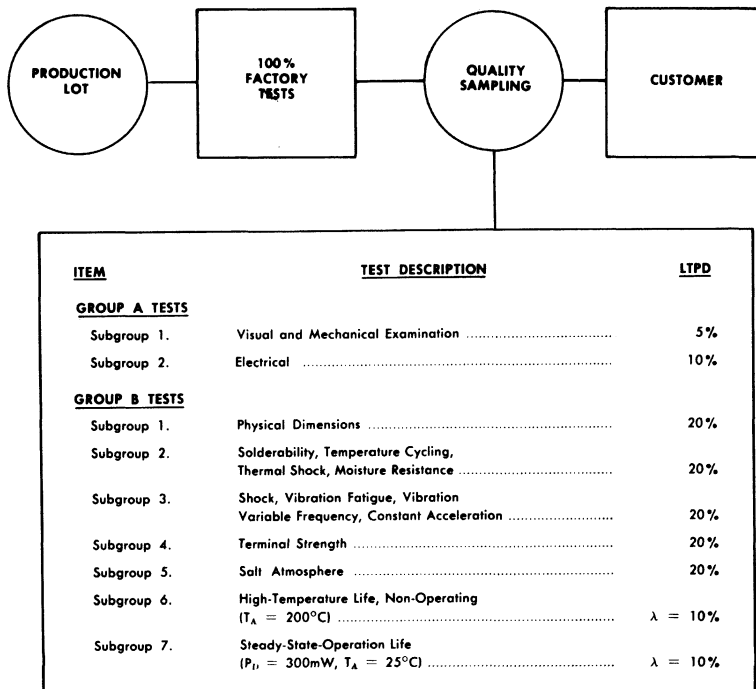


Fig. 2 - Group A and Group B Quality Sampling Tests.

2N5180

Silicon N-P-N Epitaxial Planar Transistor

For VHF Applications in Industrial and Commercial Equipment

MAXIMUM RATINGS, Absolute-Maximum Values:

*COLLECTOR-TO-BASE VOLTAGE	V_{CBO}	30	V
*COLLECTOR-TO-EMITTER VOLTAGE	V_{CEO}	15	V
*EMITTER-TO-BASE VOLTAGE	V_{EBO}	2	V
*CONTINUOUS COLLECTOR CURRENT	I_C	limited by dissipation	
*TRANSISTOR DISSIPATION:	P_T		
At ambient temperatures up to 25°C		180	mW
At ambient temperatures above 25°C		See Fig.2	
*TEMPERATURE RANGE:			
Storage & Operating (Junction)		-65 to 175	°C
*LEAD TEMPERATURE (During Soldering):			
At distances $\geq 1/32$ in. (0.8 mm) from seating plane for 10 s max.		265	°C

* Measured at center of seating surface.

Features:

- High gain-bandwidth product
- Low noise figure
- High unneutralized power gain
- Hermetically sealed four-lead metal package
- All active elements insulated from case
- Low collector-to-base feedback

TERMINAL DESIGNATIONS



CASE
92CS-27513

JEDEC TO-72

ELECTRICAL CHARACTERISTICS, at $T_A = 25^\circ\text{C}$

Characteristics	Symbols	TEST CONDITIONS					LIMITS			Units
		Frequency f	DC Collector-to-Base Voltage V_{CB}	DC Collector-to-Emitter Voltage V_{CE}	DC Emitter Current I_E	DC Collector Current I_C	Type 2N5180			
							MHz	V	V	
* Collector-Cutoff Current	I_{CBO}		8		0		-	-	0.5	μA
* Collector-to-Base Breakdown Voltage	BV_{CBO}				0	0.001	30	-	-	V
* Collector-to-Emitter Breakdown Voltage	BV_{CEO}					0.001	15	-	-	V
* Emitter-to-Base Breakdown Voltage	BV_{EBO}				-0.001	0	2	-	-	V
* Static Forward-Current Transfer Ratio	h_{FE}			8		2	20	-	200	
* Magnitude of Small-Signal Forward-Current Transfer Ratio	$ h_{fe} ^a$	100		8		2	6.5	9	17	
* Collector-to-Base Feedback Capacitance	C_{cb}^b	0.1 to 1	8		0		-	-	1	pF
* Small Signal, Common-Emitter Power Gain in Unneutralized Amplifier Circuit	G_{PE}^a	200		10		2	12	-	19	dB
VHF Noise Figure	N_{Fa} N_{Fc}	200 60		8 8		2 1	- -	- 2.5	4.5	dB dB
* Collector-Base Time Constant	$\tau_b^c C_C$	31.9	8		-2		2	-	16	ps
* Real Part of Common-Emitter Small-Signal Short-Circuit Input Impedance	$R_{\alpha}(h_{ie})$	200		10		2	60	-	240	Ω
* Bandwidth	BW	200		10		2	650	-	1700	MHz

^aFourth lead (case) grounded.

^b C_{cb} is a three terminal measurement of the collector-to-base capacitance with the emitter and case connected to the guard terminal.

* In accordance with JEDEC registration data format JS-9 RDF-1.

^cSource Resistance, $R_s = 400$ ohms.

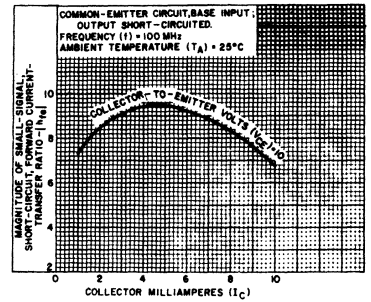


Fig. 1 - Typical small-signal beta characteristics for 2N5180.

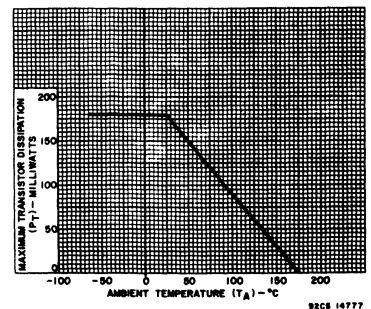


Fig. 2 - Rating chart for 2N5180.

2N5913

Silicon N-P-N Overlay Transistor

12.5-Volt, High-Gain Type for Class-C Amplifiers in VHF/UHF Communications Equipment

MAXIMUM RATINGS, Absolute-Maximum Values:

* COLLECTOR-TO-BASE VOLTAGE: V_{CBO}	36 V	* TRANSISTOR DISSIPATION: P_T	3.5 W
COLLECTOR-TO-EMITTER BREAKDOWN VOLTAGE:		At case temperatures up to 75°C	
With base shorted to emitter	$V_{(BR)CES}$ 36 V	At case temperatures above 75°C	Derate at 0.0028 W/°C
* With base open	$V_{(BR)CEO}$ 14 V	* TEMPERATURE RANGE:	
* EMITTER-TO-BASE VOLTAGE: V_{EBO}	3.5 V	Storage & Operating (Junction)	-65 to +200 °C
* CONTINUOUS COLLECTOR CURRENT: I_C	0.33 A	* LEAD TEMPERATURE:	
		At distances $\geq 1/32$ in. (0.8 mm) from seating plane for 10 s max.	230 °C

ELECTRICAL CHARACTERISTICS Case Temperature (T_C) = 25°C Unless Otherwise Specified

STATIC

CHARACTERISTIC	SYMBOL	TEST CONDITIONS					LIMITS		UNITS
		DC Voltage (V)		DC Current (mA)			Min.	Max.	
		V_{CE}	V_{EB}	I_E	I_B	I_C			
* Collector-Cutoff Current									
Base Connected to Emitter	I_{CES}	12.5		0			1.0 ^b	mA	
Base Open	I_{CEO}	10		0			0.3	mA	
* Collector-to-Base Breakdown Voltage	$V_{(BR)CBO}$			0	0.5	36	-	V	
* Collector-to-Emitter Breakdown Voltage:									
With base open	$V_{(BR)CEO}$			0	25°	14	-	V	
With base connected to emitter	$V_{(BR)CES}$		0		25°	36	-	V	
* Emitter-to-Base Breakdown Voltage	$V_{(BR)EBO}$			0.5	0	3.5	-	V	
Thermal Resistance: (Junction-to-Case)	θ_{JC}						35.7	°C/W	

^a Pulsed through a 25-mH inductor; duty factor = 50%.

^b $T_C = 100^\circ\text{C}$.

DYNAMIC

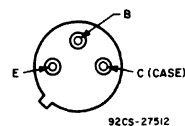
TEST & CONDITIONS	SYMBOL	FREQUENCY MHz	LIMITS		UNITS
			MINIMUM	TYPICAL	
Power Output ($V_{CC} = 12.5$ V): $P_{IE} = 0.1$ W	P_{OE}	175	1.75		W
* Large-Signal Common-Emitter Power Gain ($V_{CC} = 12.5$ V): $P_{IE} = 0.1$ W	G_{PE}	175	12.4		dB
* Collector Efficiency ($V_{CC} = 12.5$ V): $P_{IE} = 0.1$ W	η_C	175	50		%
* Common-Base Output Capacitance $V_{CB} = 12$ V	C_{dcb}	1	15 (max.)		pF

* In accordance with JEDEC registration data format JS-6 RDF-3/JS-9 RDF-7.

Features:

- High Power Gain, High Power Output ...
- At 12.5 V:
 - 2-W (typ.) output at 470 MHz (7-dB gain)
 - 2-W (typ.) output at 250 MHz (9-dB gain)
 - 2-W (typ.) output at 175 MHz (13-dB gain)
- At 8 V:
 - 1.5-W (typ.) output at 470 MHz (4.8-dB gain)
 - 1.5-W (typ.) output at 250 MHz (7.0-dB gain)
 - 1.5-W (typ.) output at 175 MHz (10-dB gain)

TERMINAL DESIGNATIONS



JEDEC TO-39

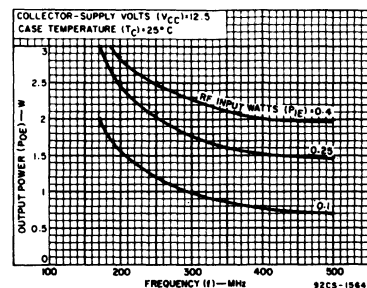


Fig. 1 - Typical power output as a function of frequency.

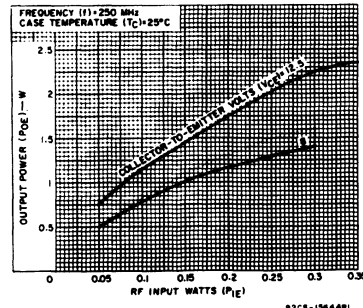


Fig. 2 - Typical power output as a function of power input at 250 MHz.

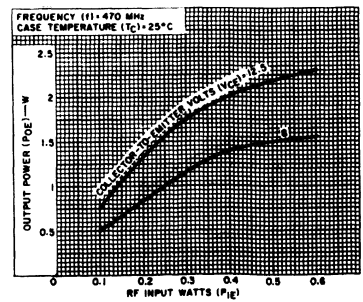


Fig. 3 - Typical power output as a function of power input at 470 MHz.

2N6670

Silicon N-P-N Epitaxial Planar Transistor

Output Device for Class C AM Operation in 27 MHz "CB" and VHF Communications Equipments

The RCA-2N6670[®] is a silicon n-p-n epitaxial planar transistor intended for use in mobile citizen-band (CB) transmitters operating from a 12.5 V supply as a class C AM rf output device. It is useful for class C output, driver,

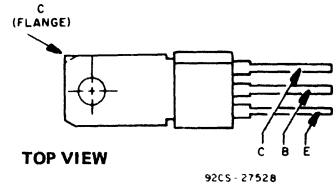
or predriver stages in FM and CW service up to 80 MHz. This type is supplied in the JEDEC TO-202AB molded-plastic (VERSATAB) package.

• Formerly RCA Dev. No. TA9124.

Features:

- Designed for vhf "CB" transmitters
- 4-W output at 27 MHz (12.5 V_{CC})
- Infinite vswr capability (12.5 V_{CC}, 27 MHz)
- Can retrofit TO-220 sockets

TERMINAL DESIGNATIONS



JEDEC TO-202AB

MAXIMUM RATINGS, Absolute-Maximum Values:

V _{CES}	100	V
V _{CBO}	80	V
V _{CEO(sus)}	50	V
V _{EBO}	3	V
I _C (Continuous)	1.5	A
P _T		
T _C ≤ 25°C	10	W
T _C > 25°C	0.08	W/°C
Derate linearly		
T _J , T _{stg}	-65 to 150	°C
T _L During soldering [At distance ≥ 1/8 in. (3.17 mm) from molded plastic package measured either along terminals or mounting flange for 10 s max.]	230	°C

• In accordance with JEDEC registration data format JS-6 RDF-3/JS-9 RDF-7

ELECTRICAL CHARACTERISTICS, At Case Temperature (T_C) = 25°C

STATIC

CHARACTERISTIC	SYMBOL	TEST CONDITIONS			LIMITS		UNITS
		DC Collector Voltage-V		DC Current mA	MIN.	MAX.	
		V _{CB}	V _{CE}	I _C			
Collector-Cutoff Current:							
At T _C = 100°C	I _{CES}		60		-	10	μA
With base open	I _{CEO}		30		-	10	
With emitter open	I _{CBO}	15			-	10	
Collector-to-Base Breakdown Voltage	V _{(BR)CBO}			0.5	80	-	V
Collector-to-Emitter Breakdown Voltage:							
With base shorted	V _{(BR)CES}			50	100	-	V
Collector-to-Emitter Breakdown Voltage:							
With R _{BE} = 10 Ω	V _{(BR)CER}			0.1	90	-	V
Collector-to-Emitter Sustaining Voltage:							
With base open	V _{CEO(sus)}			200 ^a	50	-	V
Emitter-to-Base Breakdown Voltage							
I _E = 1 mA	V _{(BR)EBO}			0	3	-	V
DC Forward Current Transfer Ratio	h _{FE}		2	400	30	-	
Thermal Resistance (Junction-to-Case)	R _{θJC}						12.5 °C/W

^a Pulsed; pulse duration < 300 μs, duty factor < 2%.

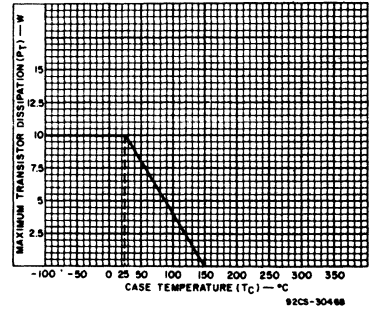


Fig. 1 - Derating curve.

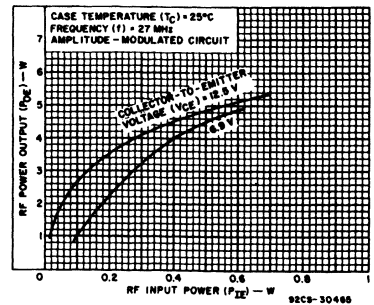


Fig. 2 - Typical output power as a function of input power at 27 MHz.

2N6670

ELECTRICAL CHARACTERISTICS, At Case Temperature (T_C) = 25°C (cont'd)

DYNAMIC

CHARACTERISTIC	SYMBOL	TEST CONDITIONS			LIMITS		UNITS
		DC Collector Supply (V_{CC})—V	Input Power (P_{IE})—W	Frequency (f) - MHz	MIN.	MAX.	
Power Output	P_{OE}	12.5	0.4	27	4b	—	W
Power Gain	G_{pE}	12.5	0.4	27	10	—	dB
Collector Efficiency	η_C	12.5	0.4	27	65 ^c	—	%
Modulation Index	m	25	0.4 (mod.)	27	85 ^d	95 (typ.)	
Load Mismatch $\infty:1$	VSWR	25	1.6 ^{d,e}	27	1	—	cycle
Collector-to-Base Capacitance	C_{obo}	$V_{CB} = 12.5V$	—	1	—	50	pF

- ^a In accordance with JEDEC registration data.
- ^b Circuit in Fig. 8 tuned for optimum AM performance.
- ^c Circuit in Fig. 8 tuned for optimum AM performance, output power adjusted for maximum legal limit (4 W carrier).
- ^d Pulsed input; 1 kHz square wave, 50% duty cycle.
- ^e Peak envelope power (PEP).

TYPICAL APPLICATION INFORMATION

APPLICATION	DC Collector Supply Voltage (V_{CC})—V	Input Power (P_{IE})—W	Output Power (P_{OE})—W	Collector Efficiency (η_C)—%
27-MHz CB Driver/Amplifier	12.5	0.04	4	
40-MHz Class C Amplifier	12.5	0.5	5	70
$I_C = 0.8 A$	12.5	1	7	—

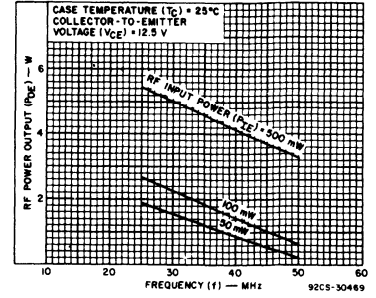


Fig. 3 — Typical rf output power as a function of frequency at $V_{CC} = 12.5 V$.

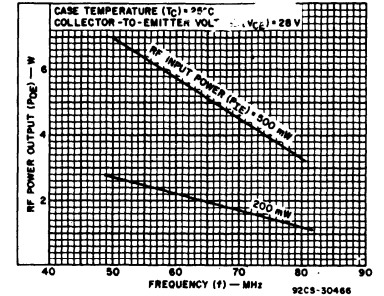


Fig. 4 — Typical rf output power as a function of frequency at $V_{CC} = 28 V$.

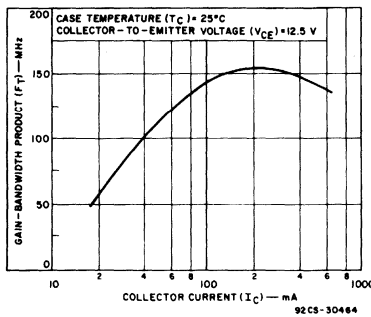


Fig. 5 — Typical gain-bandwidth product as a function of collector current.

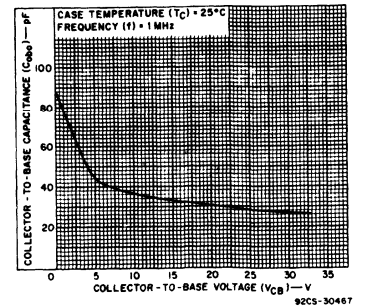


Fig. 6 — Typical collector-to-base capacitance as a function of collector-to-base voltage.

40280

1W, 175-MHz Overlay Transistor

Silicon N-P-N Devices for High-Power VHF Amplifier Service

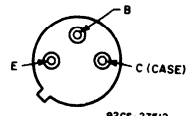
Features:

- Suitable for low-voltage supplies (13.5 V)
- High output power at 175 MHz, unneutralized class C amplifier
- High efficiency at 175 MHz
- Low input impedance

MAXIMUM RATINGS, Absolute-Maximum Values:

	40280	
COLLECTOR-TO-BASE VOLTAGE	V_{CB0}	36 V
COLLECTOR-TO-EMITTER VOLTAGE:		
With base open	V_{CEO}	18 V
With $V_{BE} = -1.5V$	V_{CEV}	36 V
EMITTER-TO-BASE VOLTAGE	V_{EBO}	4 V
COLLECTOR CURRENT	I_C	0.5 A
TRANSISTOR DISSIPATION P_{T0} :		
At case temperatures up to 25°C		7.0 W
At case temperatures above 25°C		Derate linearly to 0 watts at 200°C
TEMPERATURE RANGE:		
Storage & Operating (Junction)		-65 to 200 °C
LEAD TEMPERATURE (During soldering):		
At distances $\geq 1/32$ in. (0.8 mm) from seating plane for 10 s max.		230 °C

TERMINAL DESIGNATIONS



40280
JEDEC TO-39

ELECTRICAL CHARACTERISTICS At Case Temperature (T_C) = 25 °C

Characteristics	Symbol	TEST CONDITIONS						LIMITS		Units
		DC Collector Volts		DC Base Volts		DC Current (Milliamperes)		Type 40280		
		V_{CB}	V_{CE}	V_{BE}	I_E	I_B	I_C	Min.		
Collector Cutoff Current	I_{CEO}		15			0		-	100	μA
Collector-to-Base Breakdown Voltage	BV_{CB0}				0	0.25	36	-		V
Emitter-to-Base Breakdown Voltage	BV_{EBO}				0.10		0	4	-	V
Collector-to-Emmitter Breakdown Voltage	BV_{CEV}			-1.5			200 ^a	36	-	V
Collector-to-Emmitter Sustaining Voltage	$V_{CEO(sus)}$					0	200 ^a	18	-	V
Real Part of Common-Emitter High Frequency Input Impedance (At $f = 175$ MHz)	h_{ie} (real)		13.5				100	10 (typ.)		Ω
RF Power Output: As Class-C Amplifier, Unneutralized (At $f = 175$ MHz)	P_{OUT}		13.5					1 ^b	-	W
Gain-Bandwidth Product	f_T		13.5				100	550 (typ.)		MHz
Collector-to-Base Capacitance (At $f = 1$ MHz)	C_{ob}	13.5			0			-	15	pF
Collector-to-Case Capacitance	C_c							-	-	pF
Thermal Resistance Junction-to-Case	θ_{J-C}							-	25	$^{\circ}C/W$

^aPulsed through an inductor (25 mHz) duty factor = 50%. ^bFor $P_{IN} = 0.125$ w; minimum efficiency = 60%.

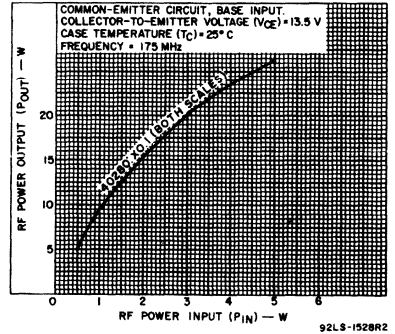


Fig. 1 - Typical RF power output vs. RF power input at 175-MHz.

40290-40292

SILICON N-P-N "overlay" TRANSISTORS

For Low Supply Voltage, High Power Output, Amplitude Modulated,
VHF Class-C Amplifier Service in Aircraft, Military, and Industrial
Communications Equipment

Features:

- High carrier output power as 136 MHz Class-C amplifier with 12.5 volt collector supply voltage
40290 — 2 watts (min.) at $P_{IN} = 0.5$ watt
40291 — 2 watts (min.) at $P_{IN} = 0.5$ watt
40292 — 6 watts (min.) at $P_{IN} = 2.0$ watts
- 100% testing of all transistors performed to assure excellent upward modulation characteristics
- High collector efficiency at 136 MHz
- All electrodes isolated from case (40291 and 40292)

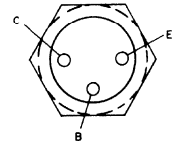
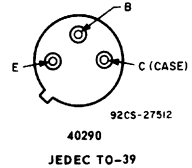
Maximum Ratings, Absolute-Maximum Values:

	40290	40291	40292
COLLECTOR-TO-EMITTER VOLTAGE:			
With $V_{BE} = -1.5$ volts,			
V_{CEX} at $f = 100$ Mc,	50	50	50
$V_{CEV}(RF)$,	90	90	90
EMITTER-TO-BASE VOLTAGE, V_{EB0}:			
	4	4	4
COLLECTOR CURRENT, I_C:			
	0.5	0.5	1.25
TRANSISTOR DISSIPATION, P_T:			
At case temperatures up to 25° C,	7.0	11.6	23.2
above 25° C,	Derate linearly to 0 watts at 200° C		

40290 40291 40292

TEMPERATURE RANGE:		
Storage		-65 to 200°C
Operating (Junction)		-65 to 200°C
PIN OR LEAD TEMPERATURE		
(During soldering):		
At distances $\geq 1/32$ from insulating wafer (TO-60 package) or from seating plane (TO-39 package) for 10 seconds maximum		
	230	°C

TERMINAL DESIGNATIONS



ELECTRICAL CHARACTERISTICS, At Case Temperature (T_C) = 25°C

CHARACTERISTIC	SYMBOL	TEST CONDITIONS						LIMITS						UNITS
		DC Collector Volts		DC Base Volts	DC Current (Milliamperes)			Type 40290		Type 40291		Type 40292		
		V_{CB}	V_{CE}	V_{BE}	I_E	I_B	I_C	Min.	Max.	Min.	Max.	Min.	Max.	
Collector Cutoff Current	I_{CEO}		15			0		-	100	-	100	-	250	μ a
Emitter-to-Base Breakdown Voltage	BV_{EBO}				0.1	0	4.0	-	4.0	-	-	-	-	Volts
					0.25	0	-	-	-	-	4.0	-	-	Volts
Collector-to-Emitter Breakdown Voltage	BV_{CEX}			-1.5			200 ^a	50	-	50	-	50	-	Volts
Real Part of Common-Emitter Input Impedance (At $f = 136$ MHz)	$h_{ie}(\text{real})$	12.5					100	12(Typ.)		12(Typ.)		-	-	ohms
		12.5					400	-	-	-	-	6.5(Typ.)	-	ohms
RF Carrier Power Output: As Class-C Amplifier, (At $f = 136$ MHz)	P_{OUT}	12.5						2.0 ^c	-	2.0 ^c	-	6.0 ^d	-	watts
Gain-Bandwidth Product	f_T	12.5					100	500(Typ.)		500(Typ.)		-	-	MHz
		12.5					400	-	-	-	-	300(Typ.)	-	MHz
Collector-to-Base Capacitance (At $f = 1$ MHz)	C_{ob}	12.5		0				-	17	-	17	-	30	pF
Collector-to-Case Capacitance	C_s							-	-	-	6.0	-	6.0	pF
Thermal Resistance (Junction-to-Case)	θ_{J-C}							-	25	-	15	-	7.5	°C/W

^aPulsed through an inductor (25 mh);

$R_{BE} = 39$ ohms; duty factor = 50%.

^cFor $P_{IN} = 0.5$ w; minimum efficiency = 70%.

^bAt frequencies of 100 Mc or higher.

^dFor $P_{IN} = 2.0$ w; minimum efficiency = 70%.

40340, 40341

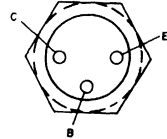
High-Power 50-MHz Emitter-Ballasted Silicon N-P-N Overlay Transistors

For 13.5-V and 24-V Applications in Mobile Communications Equipment

Features:

- Emitter ballasting resistors
- 13.5 V–25 W min. power output, 7 dB min. gain (40340)
- 24 V–30 W min. power output, 10 dB min. gain (40341)
- Emitter connected to case
- Infinite load mismatch tested at 50 MHz

TERMINAL DESIGNATIONS



92CS-27481

JEDEC TO-80

MAXIMUM RATINGS, Absolute-Maximum Values:

	40340	40341	
COLLECTOR-TO-EMITTER VOLTAGE:			
With base open	V _{CEO}	25	35
With base-emitter junction reverse-biased (V _{BE}) = -1.5 volts	V _{CEV}	60	70
COLLECTOR-TO-BASE VOLTAGE	V _{CB0}	60	70
EMITTER-TO-BASE VOLTAGE	V _{EBO}	4.0	4.0
PEAK COLLECTOR CURRENT		10	10
CONTINUOUS COLLECTOR CURRENT	I _C	3.3	3.3
TRANSISTOR DISSIPATION	P _T		
At case temperatures up to 25°C		70	70
TEMPERATURE (Operating junction)	T _J	200	200

ELECTRICAL CHARACTERISTICS, At Case Temperature (T_C) = 25°C

STATIC

CHARACTERISTIC	SYMBOL	TEST CONDITIONS					LIMITS				UNITS	
		DC Collector Voltage (V)	DC Base Voltage (V)	DC Current (mA)			40340		40341			
		V _{CB}	V _{CE}	V _{BE}	I _E	I _C	Min.	Max.	Min.	Max.		
Collector-Cutoff Current:	I _{CEO}		30									mA
With base open			15									
With emitter open	I _{CBO}	50	40									
Collector-to-Emitter Breakdown Voltage:	V _{(BR)CEO}					200 ^a	25	—	35	—		V
With base-emitter junction reverse biased, and external base-to-emitter resistance (R _{BE}) = 20 Ω	V _{(BR)CEV}					200 ^a	60	—	70	—		
Emitter-to-Base Breakdown Voltage	V _{(BR)EBO}				10		4	—	4	—		V
Thermal Resistance: (Junction-to-Case)	R _{θJC}						2.5		2.5			°C/W

^a Pulsed through a 25-mH inductor; duty factor = 50%.

DYNAMIC

CHARACTERISTIC	SYMBOL	TEST CONDITIONS			LIMITS				UNITS	
		DC Collector Supply (V _{CC})—V	Input Power (P _{IE})—W	Frequency (f)—MHz	40340		40341			
					Min.	Max.	Min.	Max.		
Power Output	P _{OE}	13.5 24	5 3	50 50	25	—	—	—	—	W
Power Gain	G _{PE}	13.5 24	5 3	50 50	7	—	—	—	—	dB
Collector Efficiency	η _C	13.5 24	5 3	50 50	60	—	—	—	—	%
Load Mismatch	LM	13.5 24	5 3	50 50	GO/NO GO					
Collector-to-Base Capacitance	C _{obo}	V _{CB} = 30 V _{CB} = 15		1 1	—	—	—	—	85	pF

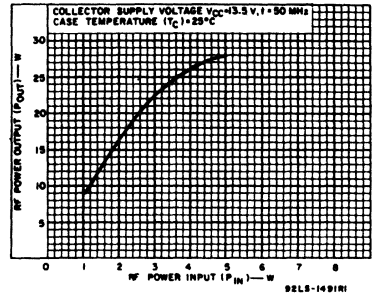


Fig. 1 - Typical performance of type 40340 in a common-emitter amplifier.

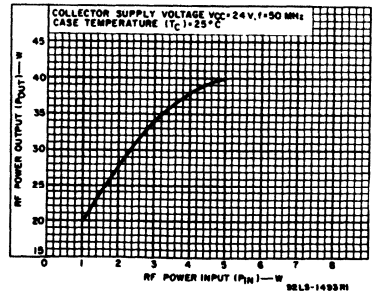


Fig. 2 - Typical performance of type 40341 in a common-emitter amplifier.

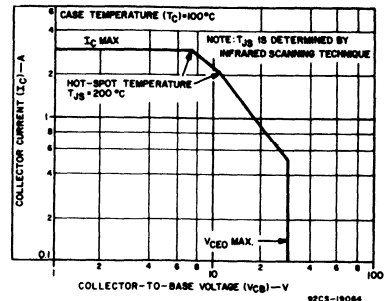


Fig. 3 - Safe area for dc operation.

40608

Silicon N-P-N Overlay Transistor

For Class A Wide-Band CATV and MATV Applications

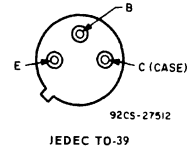
Features:

- High Gain-Bandwidth Product
- Low Cross-Modulation

MAXIMUM RATINGS, Absolute-Maximum Values:

COLLECTOR-TO-BASE VOLTAGE . . . V_{CB0}	40	V	TRANSISTOR DISSIPATION P_T	
COLLECTOR-TO-EMITTER VOLTAGE:			At case temperatures up to 25°C	3.5 W
With external base-to-emitter resistance, (R_{BE}) = 100Ω V_{CER}	40	V	At case temperatures above 25°C	See Fig. 1.
EMITTER-TO-BASE VOLTAGE V_{EBO}	2	V	TEMPERATURE RANGE:	
COLLECTOR CURRENT I_C	0.4	A	Storage & Operating (Junction)	-65 to +200 °C
			LEAD TEMPERATURE (During soldering):	
			At distances $\geq 1/32$ in. (0.79 mm) from seating plane for 10 s max.	230 °C

TERMINAL DESIGNATIONS



ELECTRICAL CHARACTERISTICS, Case Temperature = 25°C

Characteristic	Symbol	Test Conditions					Limits		Units
		DC Collector Volts		DC Current (mA)			Min.	Max.	
		V_{CB}	V_{CE}	I_E	I_B	I_C			
Collector-Cutoff Current	I_{CEO}		20	0	0		100	μA	
Collector-to-Base Breakdown Voltage	$V_{(BR)CBO}$			0		0.1	40	V	
Collector-to-Emitter Voltage (Sustaining)	$V_{CER(sus)}$					50 ^a	40	V	
Emitter-to-Base Breakdown Voltage	$V_{(BR)EBO}$			0.1		0	2	V	
Collector-to-Emitter Saturation Voltage	$V_{CE(sat)}$				10	50	1.0	V	
Collector-to-Base Capacitance (Measured at 1MHz)	C_{ob}	30		0			3.0	pF	
Gain-Bandwidth Product	f_T		15			50	700	MHz	
DC Forward-Current Transfer Ratio	h_{FE}		15			50	35 120		
Voltage Gain	VG		15			50	11	dB	
Cross Modulation @ 46 dBmV	CM		15			50	-57 (Typ.)	dB	

^a Pulsed through an inductor (20 mH), duty factor = 50%, $R_{BE} = 100 \Omega$.

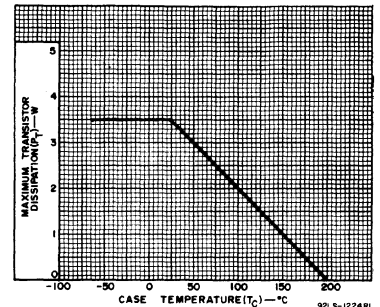


Fig. 1 - Dissipation derating curve.

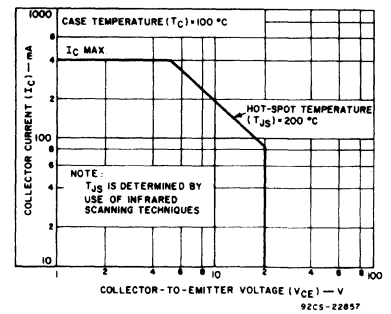


Fig. 2 - Safe area for dc operation.

40894-40897

High-Frequency Silicon N-P-N Transistors

For TV-Tuner, FM and AM/FM "Front-End", and IF Amplifier, Oscillator, and Converter Service

Features:

- High gain-bandwidth products:
 $f_T = 1200$ MHz typ. for tuner types
 $f_T = 800$ MHz typ. for if-amplifier types
- Very low collector-to-base feedback capacitance:
 $C_{cb} = 0.7$ pF typ. for 40894, 40895
- Low noise figure:
 3 dB typ. at 200 MHz for rf amplifier type
- High power gain as neutralized amplifier:
 $G_{pE} = 15$ dB min. at 200 MHz (40894)
- High power output as ulhf oscillator:
 $P_{OE} = 20$ mW typ. at 500 MHz (40896)
- Low noise figure:
 $NF = 4.5$ dB max. at 200 MHz (40894)
- Low collector-to-base time constant:
 $t_{bC} = 14$ ps max.

MAXIMUM RATINGS, Absolute-Maximum Values:

COLLECTOR-TO-EMITTER VOLTAGE	V_{CEO}	12	V
COLLECTOR-TO-BASE VOLTAGE	V_{CBO}	20	V
EMITTER-TO-BASE VOLTAGE	V_{EBO}	2.5	V
CONTINUOUS COLLECTOR CURRENT	I_C	50	mA
TRANSISTOR DISSIPATION	P_T		
With heat sink, at case temperatures up to 25°C		300	mW
With heat sink, at case temperatures above 25°C		Derate linearly 1.71	mW/ $^\circ\text{C}$
At ambient temperatures up to 25°C		200	mW
At ambient temperatures above 25°C		Derate linearly 1.14	mW/ $^\circ\text{C}$
TEMPERATURE RANGE:			
Storage & Operating (Junction)		-65 to +200	$^\circ\text{C}$
CASE TEMPERATURE (During soldering):			
At distances $\geq 1/32$ in. (0.8 mm) from seating surface for 10 seconds max.		265	$^\circ\text{C}$

TERMINAL DESIGNATIONS



CASE
92CS-27513

ELECTRICAL CHARACTERISTICS at Ambient Temperature (T_A) = 25°C unless otherwise specified

JEDEC TO-72

CHARACTERISTICS	SYMBOLS	TEST CONDITIONS									LIMITS												UNITS	
		FREQUENCY MHz	DC COLLECTOR OR EMITTER VOLTAGE V			DC CURRENT mA			TYPE 40894 RF AMPLIFIER			TYPE 40895 MIXER			TYPE 40896 OSCILLATOR			TYPE 40897 IF AMPLIFIER						
			V_{CB}	V_{CE}	V_{EB}	I_E	I_C	I_B	Min.	Typ.	Max.	Min.	Typ.	Max.	Min.	Typ.	Max.	Min.	Typ.	Max.				
Collector-Cutoff Current	I_{CBO}		15			0						-	-	0.02	-	-	0.02	-	-	0.02	-	-	0.02	μA
$T_A = 150^\circ\text{C}$			15			0						-	-	1	-	-	1	-	-	1	-	-	1	μA
Collector-to-Base Breakdown Voltage	$V_{(BR)CBO}$					0	0.001		20	-	-	20	-	-	20	-	-	20	-	-	20	-	-	V
Collector-to-Emitter Sustaining Voltage	$V_{CEO(sus)}$					3	0	15	-	-	15	-	-	15	-	-	15	-	-	15	-	-	V	
Emitter-to-Base Breakdown Voltage	$V_{(BR)EBO}$					0.01	0	2.5	-	-	2.5	-	-	2.5	-	-	2.5	-	-	2.5	-	-	V	
Collector-to-Emitter Saturation Voltage	$V_{CE(sat)}$					10	1	-	-	0.4	-	-	0.4	-	-	0.4	-	-	0.4	-	-	0.4	V	
Base-to-Emitter Saturation Voltage	$V_{BE(sat)}$					10	1	-	-	1	-	-	1	-	-	1	-	-	1	-	-	1	V	
Static Forward Current Transfer Ratio	h_{FE}			6		1		50	80	250	40	70	250	27	50	250	70	120	250					
Magnitude of Common-Emitter, Small-Signal Short-Circuit, Forward Current Transfer Ratio ^a	$ h_{fe} $	100 1 kHz		6 6		5 2		9 25	14 90	20 300	9 25	14 90	20 300	9 25	14 90	20 300	9 25	14 90	20 300	9 25	14 90	20 300		
Collector-to-Base Feedback Capacitance ^b	C_{cb}	0.1 to 1	10			0					-	0.7	1	-	0.7	1	-	0.7	1	-	0.7	1	pF	
Common-Base Input Capacitance ^c	C_{ib}	0.1 to 1			0.5	0					-	-	2	-	-	2	-	-	2	-	-	2	pF	
Collector-to-Base Time Constant ^a	t_{bC}	31.9	6			2		3	7	14	3	7	14	3	7	14	3	7	14	3	7	14	ps	
Small-Signal Power Gain in Neutralized Common-Emitter Amplifier Circuit ^a	G_{pE}	10.7 200		12 12		5 5		15 15	21 21	- -	- -	15 15	21 21	- -	- -	15 15	21 21	- -	- -	18 -	25 -	- -	dB	
Noise Figure ^a	NF	200		6		1.5		-	3	4.5	-	-	-	-	-	-	-	-	-	-	-	-	dB	

^aLead No. 4 (case) grounded; $R_g = 125\Omega$
^bThree-terminal measurement of the collector-to-base capacitance with the case and emitter leads connected to the guard terminal.
^cLead No. 4 (case) floating.

40936

20-W (PEP) Emitter-Ballasted Overlay Transistor

For 2- to-30-MHz Single-Sideband Linear Amplifier Applications

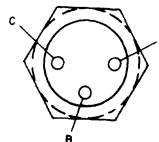
MAXIMUM RATINGS, Absolute-Maximum Values:

COLLECTOR-TO-EMITTER VOLTAGE:		TRANSISTOR DISSIPATION P_T	
With $V_{BE} = -1.5$ V	V_{CEV} 65 V	At case temperatures up to 75°C	50 W
With external base-to-emitter resistance		At case temperatures above 75°C	Derate linearly at 0.4 W/°C.
$R_{BE} = 5 \Omega$	V_{CER} 40 V	TEMPERATURE RANGE:	
EMITTER-TO-BASE VOLTAGE V_{EBO}	4 V ⁺	Storage & Operating (Junction)	-65 to 200 °C
COLLECTOR CURRENT:		LEAD TEMPERATURE (During soldering):	
Peak	10 A	At distances $\geq 1/32$ in. (0.787 mm) from insulating wafer for 10 s max	230 °C
Continuous	I_C 3.3 A		

Features:

- For class A or class B amplifier service
- Integral emitter-ballasting resistors
- 20 W(PEP) output (min.) at 30 MHz with: gain = 13 dB (min.); collector efficiency = 40% (min.); intermodulation distortion = -30 dB (max.)
- Low-Thermal-Resistance Package

TERMINAL DESIGNATIONS



92CS-27481
JEDEC TO-60

ELECTRICAL CHARACTERISTICS, at Case Temperature (T_C) = 25°C

STATIC

CHARACTERISTIC	SYMBOL	TEST CONDITIONS					LIMITS		UNITS
		DC COLLECTOR VOLTAGE (V)		DC BASE VOLTAGE (V)		DC CURRENT (mA)	MIN.	MAX.	
		V_{CB}	V_{CE}	V_{BE}	I_E	I_C			
Collector-to-Emitter Sustaining Voltage: With base-emitter junction reverse biased	$V_{CEV(sus)}$			-1.5		200 ^a	65	-	V
With external base-to-emitter resistance (R_{BE})=5 Ω	$V_{CER(sus)}$					200 ^a	40	-	V
Emitter-to-Base Breakdown Voltage	$V_{(BR)EBO}$					20	4	-	V
Collector-to-Emitter Cutoff Current	I_{CEO}		30				-	5.0	mA
Collector-to-Base Cutoff Current	I_{CBO}	60					-	10	mA
Collector-to-Base Capacitance ($f = 1$ MHz)	C_{ob0}	30					-	85	pF
Thermal Resistance (Junction-to-Case)	$R_{\theta JC}$						-	2.5	°C/W

^aPulsed through an inductor (25 mH); duty factor = 50%.

DYNAMIC (30-MHz Single-Sideband Amplifier)

CHARACTERISTIC	SYMBOL	TEST CONDITIONS				LIMITS		UNITS
		DC COLLECTOR SUPPLY VOLTAGE (V)	OUTPUT POWER W(PEP)	FREQUENCY (MHz)	DC CURRENT (mA)	MIN.	MAX.	
		V_{CC}	P_{OE}	f	I_C			
RF Input Power: Average	P_{IE}	28	10	30	20	-	0.5	W
Peak envelope (PEP)	P_{IE}	28	20	30	20	-	1.0	W
Power Gain	G_{pE}	28	20	30	20	13	-	dB
Collector Efficiency	η_C	28	20	30	20	40	-	%
Intermodulation Distortion*	IMD	28	20	30	20	-	-30	dB

*Referenced to either of the two tones, and without the use of feedback to enhance linearity.

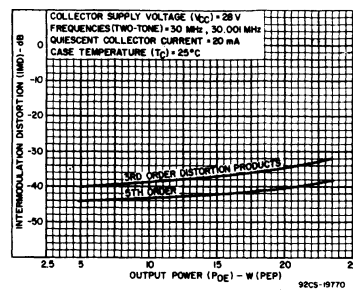


Fig. 1 - Typical intermodulation distortion as a function of output power.

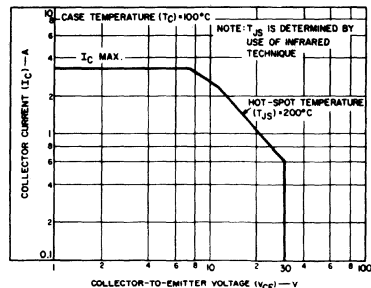


Fig. 2 - Maximum operating area for forward-bias operation.

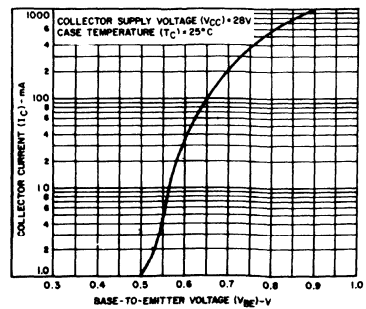


Fig. 3 - Typical transfer characteristic.

40964, 40965

Silicon N-P-N Overlay Transistors

High-Gain Devices for Class C VHF/UHF Multiplier and Amplifier Service

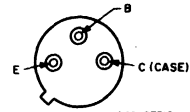
Features:

- High power gain:
 - 6 dB (min.) up to $f = 470$ MHz (40964 tripler)
 - 7 dB (min.) at $f = 470$ MHz (40965 amplifier)

MAXIMUM RATINGS, Absolute-Maximum Values:

COLLECTOR-TO-BASE VOLTAGE	V_{CB0}	36	V
COLLECTOR-TO-EMITTER SUSTAINING VOLTAGE:			
With external base-to-emitter resistance ($R_{BE} = 33\Omega$)	$V_{CER(sus)}$	36	V
With base open	$V_{CEO(sus)}$	14	V
EMITTER-TO-BASE VOLTAGE	V_{EBO}	2	V
CONTINUOUS COLLECTOR CURRENT	I_C	0.2	A
TRANSISTOR DISSIPATION:	P_T		
At case temperatures up to 25°C		3.5	W
TEMPERATURE RANGE:			
Storage & Operating (Junction)		-65 to 200	°C
LEAD TEMPERATURE (During soldering):			
At distances $\geq 1/32$ in. (0.8 mm) from seating plane for 10 s max.		230	°C

TERMINAL DESIGNATIONS



ELECTRICAL CHARACTERISTICS, Case Temperature (T_C) = 25°C

STATIC

CHARACTERISTIC	SYMBOL	TEST CONDITIONS			LIMITS		UNITS	
		Voltage V dc	Current mA dc		40964 40965			
			I_E	I_B	I_C	Min.		Max.
Collector-Cutoff Current	I_{CEO}	10	0	0	-	0.1	mA	
Collector-to-Base Breakdown Voltage	$V_{(BR)CBO}$		0			36	-	V
Collector-to-Emitter Sustaining Voltage:								
With base open	$V_{CEO(sus)}$		0	5 μ	14	-		V
With external base-to-emitter resistance ($R_{BE} = 33\Omega$)	$V_{CER(sus)}$			5 μ	36	-		V
Emitter-to-Base Breakdown Voltage	$V_{(BR)EBO}$		0.1	0	2	-		V
Thermal Resistance: (Junction-to-Case)	$R_{\theta JC}$					-	50	°C/W

*Pulsed through a 25-mH inductor; duty factor = 50%.

DYNAMIC

CHARACTERISTIC	SYMBOL	TEST CONDITIONS			LIMITS				UNITS
		Collector Supply (V_{CC}) - V dc	Input Power (P_{IE}) - W	Frequency (f) - MHz	40964		40965		
					Min.	Typ.	Min.	Typ.	
Power Output	P_{OE}	12	0.1	156.7-470	0.4	0.44	-	-	W
				470	-	-	0.5	0.55	
		8	0.1	156.7-470	-	0.33	-	-	
				470	-	-	-	0.33	
Power Gain	G_{PE}	12	0.1	156.7-470	6	6.4	-	-	dB
				470	-	-	7	7.4	
		8	0.1	156.7-470	-	5.2	-	-	
				470	-	-	-	5.2	
Collector Efficiency	η_C	12	0.1	156.7-470	25	-	-	-	%
				470	-	-	40	-	
		8	0.1	156.7-470	-	25	-	-	
				470	-	-	-	40	
Collector-to-Base Capacitance	C_{obo}	$V_{CB} = 12$ V $I_C = 0$	-	1	5 (max.)	5 (max.)	-	pF	
Gain-Bandwidth Product	f_T	$V_{CE} = 12$ V $I_C = 50$ mA	-	-	700	700	-	MHz	

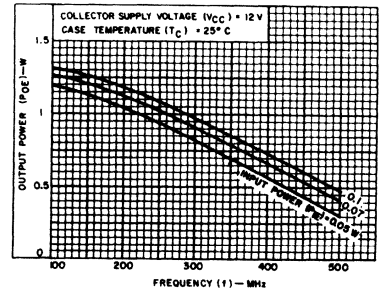


Fig. 1 - Typical power output as a function of frequency for 40965.

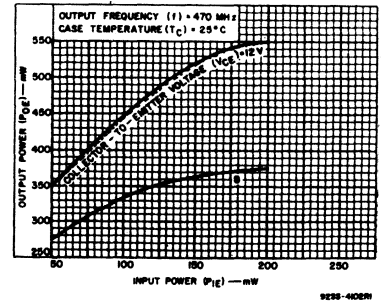


Fig. 2 - Typical power output as a function of power input for 40964.

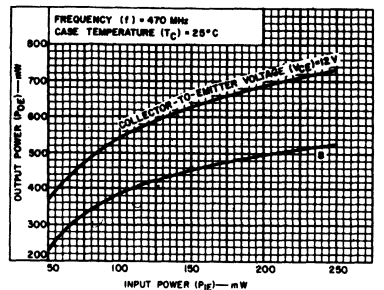


Fig. 3 - Typical power output as a function of power input for 40965.

41024

1-W, 1-GHz Silicon N-P-N Overlay Transistor

High-Gain Device for Class B- or C- Operation in UHF Circuits

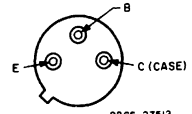
MAXIMUM RATINGS, Absolute-Maximum Values:

COLLECTOR-TO-BASE VOLTAGE	V _{CB0}	55	V
COLLECTOR TO EMITTER SUSTAINING VOLTAGE:			
With external base-to-emitter resistance (R _{BE}) = 10 Ω	V _{CER}	55	V
With base open	V _{CEO}	24	V
EMITTER-TO-BASE VOLTAGE	V _{EBO}	3	V
CONTINUOUS COLLECTOR CURRENT	I _C	0.4	A
TRANSISTOR DISSIPATION:	P _T		
At case temperatures up to 25°C		3.5	W
At case temperatures above 25°C		See Fig. 1	
TEMPERATURE RANGE:			
Storage and Operating (Junction)		-65 to 200	°C
LEAD TEMPERATURE (During soldering):			
At distances ≥ 1/32 in. (0.8 mm) from seating plane for 10 s max.		230	°C

Features:

- 1-watt output min. at 1 GHz (5 dB gain)
- For sonde applications
- 0.3-watt output typ. at 1.68 GHz (V_{CC} = 20 V)

TERMINAL DESIGNATIONS



JEDEC TO-39

ELECTRICAL CHARACTERISTICS, Case Temperature (T_C) = 25°C

CHARACTERISTIC	SYMBOL	TEST CONDITIONS					LIMITS		UNITS
		Voltage V dc		Current mA dc			Min.	Max.	
		V _{CB}	V _{CE}	I _E	I _B	I _C			
Collector Cutoff Current:									
With base open	I _{CEO}		15		0		—	20	μA
With base connected to emitter	I _{CES}		50				—	1	
Collector-to-Base Breakdown Voltage	V _{(BR)CB0}				0		55	—	V
Collector-to-Emitter Sustaining Voltage:	V _{CER(sus)}					5	55	—	V
With external base-to-emitter resistance (R _{BE}) = 10 Ω									
Emitter-to-Base Breakdown Voltage	V _{(BR)EBO}				0.1		0	3	V
Collector-to-Emitter Saturation Voltage	V _{CE(sat)}				10		100	—	0.5
Collector-to-Base Capacitance (Measured at 1 MHz)	C _{ob}		30		0		—	3.0	pF
Magnitude of Common-Emitter Small-Signal Short-Circuit Forward-Current Transfer Ratio (Measured at 200 MHz)	h _{fe}		15				50	6.0	—
RF Power Output Common Emitter Amplifier at 1 GHz	P _{OUT}		28				1 ^a	—	W

^aFor P_{IN} = 0.316 W, minimum efficiency = 36%.

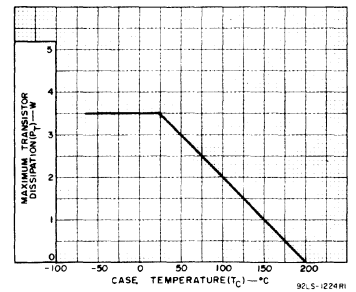


Fig. 1 - Derating curve.

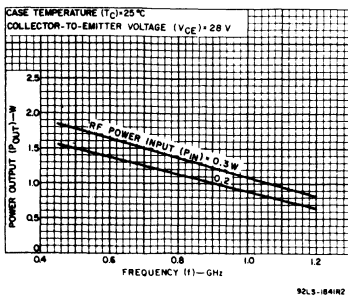


Fig. 2 - Typical power output vs. frequency.

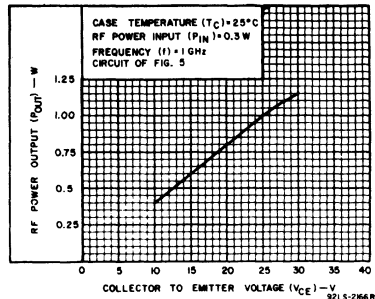


Fig. 3 - Typical rf power output as a function of collector-to-emitter voltage.

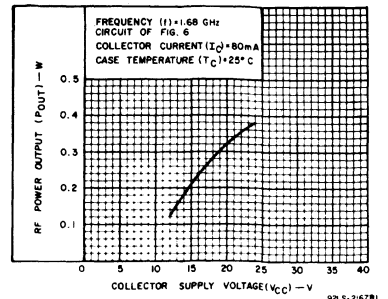


Fig. 4 - Typical oscillator power output as a function of collector supply voltage.

Power Hybrid Circuits

Technical Data

HC2000H, HC2500

Multi-Purpose 7-Ampere Operational Amplifiers

Linear Amplifiers for Applications in Industrial and Commercial Equipment

The RCA-HC2000H and HC2500 hybrid-circuit operational amplifiers are designed for operation from either single or split power supplies at output currents up to 7 amperes and power outputs up to 100 watts. These versatile amplifiers are recommended for servoamplifiers, audio power amplifiers, driven inverter, power operational amplifiers, deflection amplifiers, solenoid drivers, voltage regulators, and similar linear-amplifier power applications. They are supplied in a metal hermetic package.

The HC2000H and HC2500 employ a quasi-complementary-symmetry output stage with homotaxial-base output transistors. They feature low distortion, with a maximum total harmonic distortion of 0.5 per cent over a bandwidth of 30 kHz at a power output of 60 watts and a typical intermodulation distortion of less than 1 per cent at rms power outputs

from 0.2 to 70 watts. At an rms output of 50 milliwatts, the HC2500 has an exceptionally low typical intermodulation distortion of only 0.06 per cent.

The HC2000H includes a load-line-limiting network that provides protection against short-circuit loads and against high-energy transients when the amplifier is used to drive inductive loads. Both circuits also feature adjustable idling current and direct coupling to the load.

High-reliability versions of the HC2000H are also available for use in aerospace, military, and critical industrial applications. These types are screened to four reliability levels (1, 2, 3, and 4) that approximate the reliability classes of MIL-STD-750. These slash-series types are the electronic industry's first series of high-reliability high-power hybrid-circuit op-amps.

Features:

- Bandwidth: 30 kHz at 60 W
- High power output: up to 100 W(rms)
- High output current: 7A (peak)
- Low IMD and THD
- Adjustable idling current
- Stability with resistive or reactive loads
- Single or split power supply (30 to 75 V, single, ± 15 to ± 37.5, split)
- Class AB output stage (HC2500) Class B output stage (HC2000H)
- Direct coupling to load
- Built-in load-line-limiting circuit to protect amplifiers from accidentally short-circuited output terminals (HC2000H)
- Reactive-load fault protection (HC2000H)
- Socket available
- Rugged package with heavy leads
- Light weight: 100 grams

MAXIMUM RATINGS, Absolute-Maximum Values:

V_S :	Between leads 1 & 10	75 V
I_{OM}	Per Output Device	7 A
P_T :	Per Output Device	See Figs. 3 & 4
T_{stg}	-55 to +125°C
T_J	-55 to +150°C
T_L	(During Soldering):	
	At distance $\geq 1/8$ in. (3.17 mm) from case for 10 s max.	235°C
ϕL (Min):	At distance ≥ 0.075 (1.91 mm) from case	0.04 in. (1.02 mm)

TERMINAL DESIGNATION

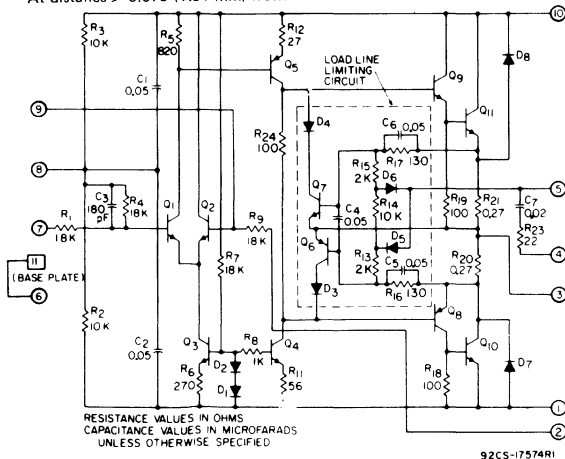
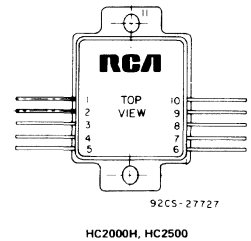


Fig. 1 - Schematic diagram of type HC2000H operational amplifier.

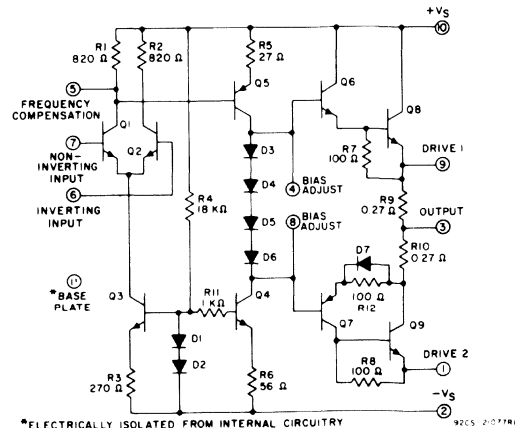


Fig. 2 - Schematic diagram of type HC2500 operational amplifier.

HC2000H, HC2500

COMPARISON CHART

TYPE	IM DIST.	OUTPUT PROTECTION NETWORK	OPERATING MODE	FREQUENCY COMPENSATION	COMMUTATING DIODES
HC2500	0.06% @ 50 mW	NO	CLASS AB	CAPACITOR ON SIGNAL TERMINALS	NO
HC2000H	0.6% @ 200 mW	YES	CLASS B	LC FILTER ON OUTPUT	YES

HC2000H

ELECTRICAL CHARACTERISTICS, At Case Temperature (T_C) = 25°C

CHARACTERISTIC	TEST CONDITIONS				LIMITS			UNITS
	V_S -V	f -kHz	P_O -W	R_L - Ω	MIN.	TYP.	MAX.	
V_{OUT}								
V_{IN} Open-Loop	± 37.5	4	25	4	-	2000	-	
Closed-Loop	± 37.5	1	1	4	26	30	-	
Z_{IN} Measured between leads 7 & 8	-	-	-	-	16	18	-	k Ω
I_o	± 37.5	-	-	-	15	-	30	mA
V_{IO} Measured between leads 4 & 5	± 37.5	-	-	4	0	± 30	± 250	mV
V_{OUT}	± 37.5	1	100	4	28	32	-	V
f_H (See Fig.9)	± 37.5	-	1	4	43	-	-	kHz
THD (See Fig. 10)	± 37.5	1	60	4	-	0.4	0.5	%
I_S (See Fig. 12)	± 37.5	1	-	0	± 2	-	± 3.85	A
S/N $Z_G = 600 \Omega$	± 37.5	-	-	-	-	78	-	dB
SR (Unity gain, $I_{OM} = 4A$)	± 37.5	1	100	4	5	-	-	V/ μs
$R_{\theta JC}$ Per Output Device (See Figs. 3 & 4)	-	-	-	-	-	-	2	$^{\circ}C/W$

HC2500

ELECTRICAL CHARACTERISTICS, At Case Temperature (T_C) = 25°C and Supply Voltage (V_S) = ± 37.5 V

CHARACTERISTIC	REFER-ENCE FIG. NO.	TEST CONDITIONS			LIMITS			UNITS	
		SPECIAL NOTES	FREQ. (f)-kHz	OUTPUT POWER (P_O)-W	LOAD RESIST. (R_L)- Ω	MIN.	TYP.		MAX.
V_{offset}		Measured Pin 3 to Gnd	-	-	4	-	-	± 250	mV
I_o		Idling Current < 1 mA	-	-	Open	-	-	± 30	mA
V_{OUT}		Peak dc voltage	0	200	4	28	-	-	V
f_H			-	1	4	43	-	-	kHz
THD	21		1	60	4	-	0.3	0.5	%
A_{CL}			1	1	4	31	32	-	
$R_{\theta JC}$	3, 4		-	-	-	-	-	2	$^{\circ}C/W$

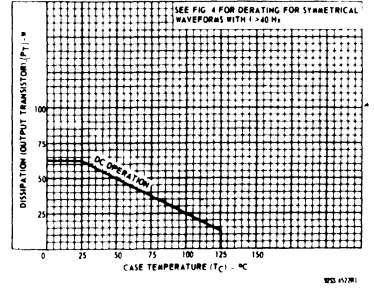


Fig. 3 - Dissipation (dc) derating curve for each output transistor for both types.

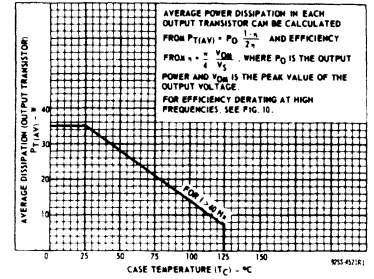


Fig. 4 - Dissipation (average) derating curve for each output transistor (for symmetrical wave-forms with $f > 40$ Hz) for both types.

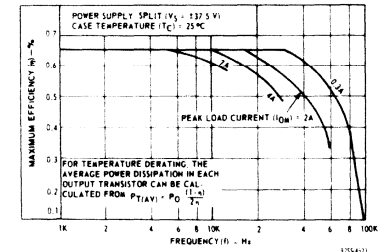


Fig. 5 - Maximum efficiency vs. frequency for several values of peak load current for both types.

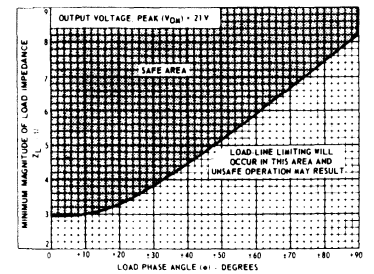


Fig. 6 - Minimum load impedance vs. load phase angle and safe area of operation for both types.

HC2000H, HC2500

HC2500

ELECTRICAL CHARACTERISTICS (Cont'd)

Typical Values (for Design Guidance), At Case Temperature (T_C) = 25°C and Supply Voltage (V_S) = ±37.5

CHARACTERISTIC	REFER- ENCE FIG. NO.	SPECIAL NOTES	TEST CONDITIONS			LIMITS			UNITS
			FREQ. (f) - kHz	OUTPUT POWER (P_O) - W	LOAD RESIST. (R_L) - Ω	MIN.	TYP.	MAX.	
A_{OL}	16	Idling current = 50 mA	1	25	4	-	70	-	dB
V_{IO}			-	0	Open	-	±10	-	mV
I_{IO}			-	0	Open	-	7	-	μA
I_{IB}			-	0	Open	-	20	-	μA
R_{CM}			0.005	0	Open	-	1	-	MΩ
V_{ICR}			0.5	100	4	-	32	-	V
CMRR			0.005	0	Open	-	50	-	dB
V_{RR}			0.06	0	4	-	30	-	dB
IMD	20	Idling current = 50 mA	-	0.05	4	-	0.06	-	%
SR	24	$A_{CL} = 2$ $C_C = 100$ pF	0.5 Square Wave	-	4	-	4.3	-	V/μs
Δ_i	23	25°C to 100°C	-	-	4	-	1	-	mA/°C

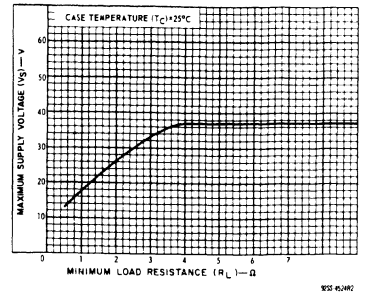


Fig. 7 - Maximum allowable supply voltage vs. load resistance for HC2000H.

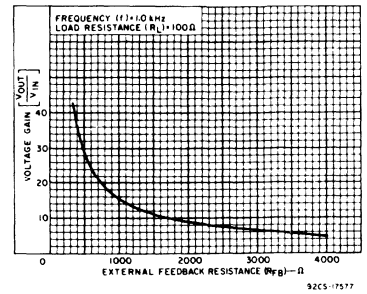


Fig. 8 - Closed-loop voltage gain vs. external feedback resistance for HC2000H.

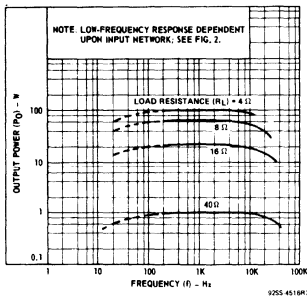


Fig. 9 - Output power vs. frequency for HC2000H.

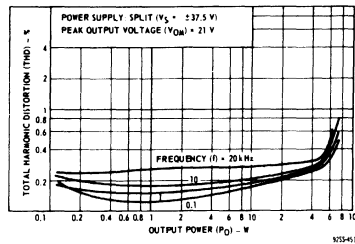


Fig. 10 - Total harmonic distortion with split power supply for HC2000H.

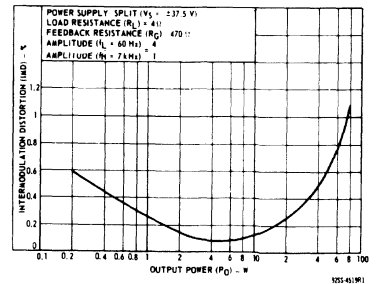


Fig. 11 - Intermodulation distortion with split supply and 4-ohm load for HC2000H.

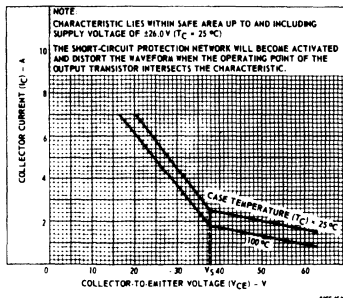


Fig. 12 - Characteristics of built-in load-line-limiting circuit for HC2000H.

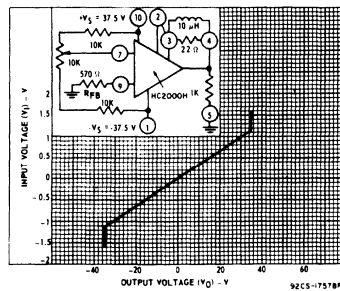


Fig. 13 - Gain linearity characteristics for HC2000H.

HC2000H, HC2500

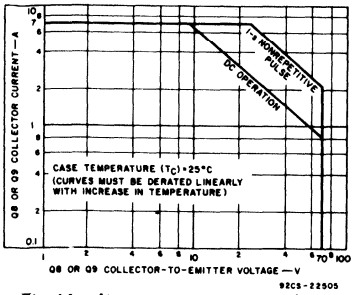


Fig. 14 - Maximum operating area for HC2500.

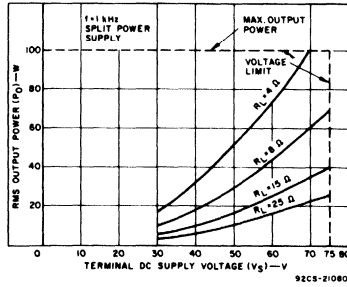


Fig. 15 - Output power as a function of supply voltage, with various values of load resistance, for symmetrical sine-wave operation for HC2500.

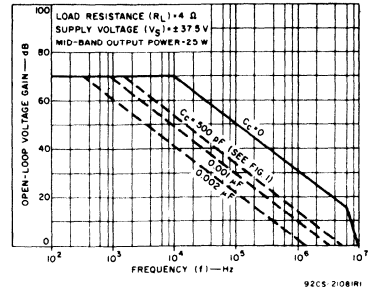


Fig. 16 - Typical open-loop voltage gain vs. frequency for HC2500.

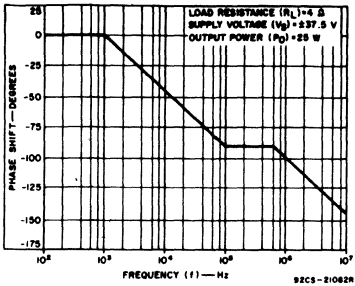


Fig. 17 - Typical open-loop phase shift vs. frequency for HC2500.

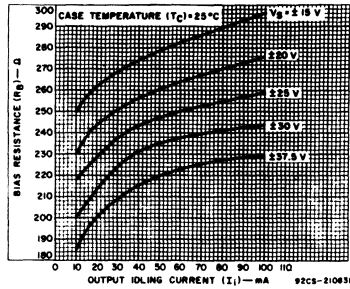


Fig. 18 - Bias resistor value vs. output idling current (I_i) for HC2500.

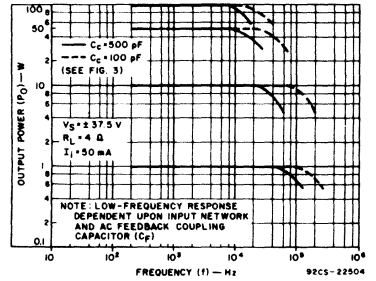


Fig. 19 - Output power vs. frequency for HC2500.

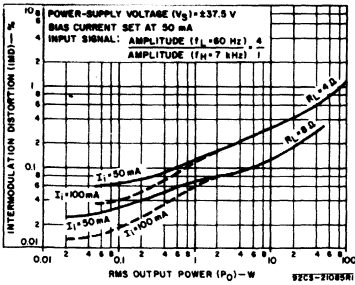


Fig. 20 - Typical intermodulation distortion vs. rms output power for HC2500.

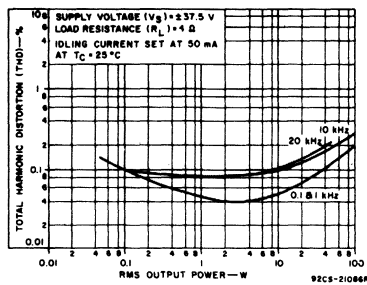


Fig. 21 - Typical harmonic distortion vs. rms output power for HC2500.

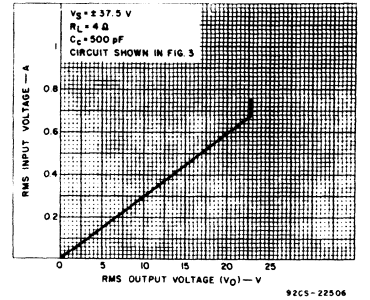


Fig. 22 - Input sensitivity for HC2500.

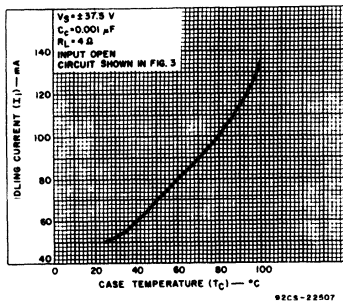


Fig. 23 - Typical idling-current drift for HC2500.

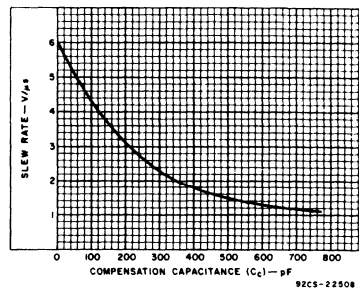


Fig. 24 - Typical slew rate vs. value of compensation capacitor C_c for HC2500.

Triacs

Technical Data

T2300, T2301, T2302, T2310, T2311, T2312 Series

2.5-A Sensitive-Gate Silicon Triacs

Mod. TO-5 and Mod. TO-5 with Heat Radiator Packages For AC Power Switching

The RCA-T2300, T2301, T2302, T2310, T2311, T2312 series triacs are gate-controlled full-wave silicon ac switches that are designed to switch from an off-state to an on-state for either polarity of applied voltage with positive or negative gate triggering voltages.

The T2310, T2311, and T2312 series are the

same as the T2300, T2301, and T2302 series, respectively, but have factory-attached heat radiators and are intended for printed-circuit-board applications.

The gate sensitivity of these triacs permits the use of economical transistorized control circuits and enhances their use in low-power phase-control and load-switching applications.

MAXIMUM RATINGS, Absolute-Maximum Values:
For Operation with Sinusoidal Supply Voltage at Frequencies Up to 50/60 Hz and with Resistive or Inductive Load

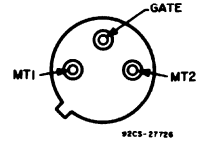
	3 mA Gate	T2300F	T2300A	T2300B	T2300D	
V_{DROM}^A Gate open, $T_J = -40$ to $100^\circ C$	50	100	200	400		V
$I_T(RMS)$ ($\theta = 360^\circ$):			2.5			A
$T_C = 70^\circ C$			1.9			A
$T_A = 25^\circ C$			See Figs. 2,3,4,5			
For other conditions						
I_{TSM}^* For one cycle of applied principal voltage, at current and temperature shown						
above for $I_T(RMS)$:						
60 Hz (sinusoidal)			25			A
50 Hz (sinusoidal)			21			A
For more than one cycle of applied principal voltage			See Figs. 6,7			
di/dt:						
$V_D = V_{DROM}$, $I_{GT} = 50$ mA, $t_r = 0.1 \mu s$			100			A/ μs
I^2t [At T_C shown for $I_T(RMS)$]:						
$t = 20$ ms			4.3			A^2s
$= 2.5$ ms			2			A^2s
$= 0.5$ ms			1			A^2s
For other time values			See Fig. 7			
I_{GTM}^* For 1 μs max.			1			A
P_{GM} Peak (For 1 μs max., $I_{GTM} \leq 1$ A(peak)			10			W
$P_G(AV)$ $T_C = 60^\circ C$			0.15			W
$T_A = 25^\circ C$			0.05			W
T_{stg}			-40 to 150			$^\circ C$
T_C			-40 to 100			$^\circ C$
T_T During soldering for 10 s maximum at distance $\geq 1/16$ in. (1.58 mm) from seating plane			225			$^\circ C$

^A For either polarity of main terminal 2 voltage (V_{MT2}) with reference to main terminal 1.
^{*} For either polarity of gate voltage (V_G) with reference to main terminal 1.
^{*} For temperature measurement reference point, see Dimensional Outlines.

Features:

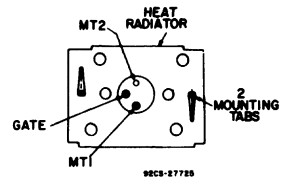
- Very high gate sensitivity—3, 4, and 10 mA
- di/dt capability—100 A/ μs
- Shorted-emitter, center-gate design
- Low switching losses
- Low on-state voltage at high current levels

TERMINAL CONNECTIONS



T2300
T2301
T2302
Series

Modified TO-5



T2310
T2311
T2312
Series

Mod. TO-5 with Heat Radiator

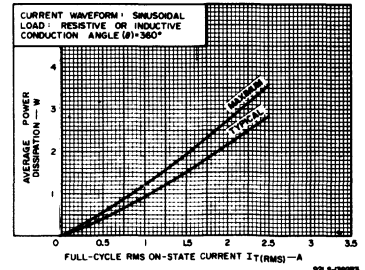


Fig. 1—Power dissipation vs. on-state current.

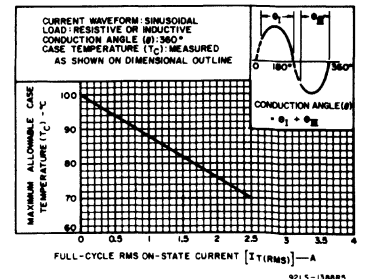


Fig. 2—Maximum allowable case temperature vs. on-state current.

T2300, T2301, T2302, T2310, T2311, T2312 Series

ELECTRICAL CHARACTERISTICS

At Maximum Ratings Unless Otherwise Specified and at Indicated Case Temperature (T_C)

CHARACTERISTIC	LIMITS			UNITS
	FOR ALL TYPES Except as Specified			
	Min.	Typ.	Max.	
I_{DROM}^{Δ} : Gate open, $T_J=100^{\circ}C$, $V_{DROM}=\text{Max. rated value}$	-	0.2	0.75	mA
V_{TM}^{Δ} : $i_T=10$ A (peak), $T_C=25^{\circ}C$	-	1.7	2.2	V
I_{HO}^{Δ} : Gate open, Initial principal current=150 mA (dc), $v_D=12$ V, $T_C=25^{\circ}C$ (T2300, T2301, T2310, T2311 series) (T2302, T2312 series)	-	2 7	5 15	mA
dv/dt (Commutating) $^{\Delta}$: $v_D=V_{DROM}$, $I_T(RMS)=2.5$ A, commutating $di/dt=0.95$ A/ms, gate unenergized, $T_C=100^{\circ}C$	0.5	-	-	V/ μ s
dv/dt (Off-state) $^{\Delta}$: $v_D=V_{DROM}$, exponential voltage rise, gate open, $T_C=90^{\circ}C$ (T2300, T2301, T2310, T2311 series) $T_C=100^{\circ}C$ (T2302, T2312 series)	3 6	5 10	-	V/ μ s
I_{GT}^{Δ} : $v_D=12$ V dc, $R_L=30 \Omega$, $T_C=25^{\circ}C$ Mode V_{MT2} V_G I^+ positive positive T2300, T2310 series T2301, T2311 series T2302, T2312 series III^- negative negative T2300, T2310 series T2301, T2311 series T2302, T2312 series I^- positive negative * T2300, T2310 series T2301, T2311 series T2302, T2312 series III^+ negative positive T2300, T2310 series T2301, T2311 series T2302, T2312 series	-	1 1 3.5 1 1 3.5 2 2 7 2 2 7	3 4 10 3 4 10 3 4 10 3 4 10	mA
V_{GT}^{Δ} : $v_D=12$ V dc, $R_L=30 \Omega$, $T_C=25^{\circ}C$ $v_D=V_{DROM}$, $R_L=3$ k Ω , $T_C=100^{\circ}C$	-	1	2.2	V
t_{gt} : $v_D=V_{DROM}$, $I_{GT}=60$ mA, $t_r=0.1$ μ s, $i_T=10$ A (peak), $T_C=25^{\circ}C$	-	1.8	2.5	μ s
$R_{\theta JC}$: Steady-state	-	-	8.5	$^{\circ}C/W$
$R_{\theta JA}$	-	-	150	$^{\circ}C/W$

Δ For either polarity of main terminal 2 voltage (V_{MT2}) with reference to main terminal 1.
 \bullet For either polarity of gate voltage (V_G) with reference to main terminal 1.

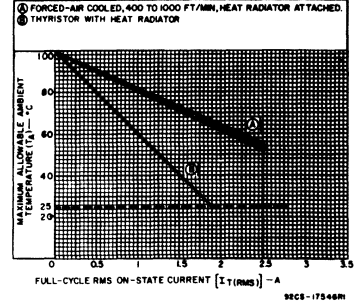


Fig. 3—Maximum allowable ambient temperature vs. on-state current for T2310, T2311, T2312 series.

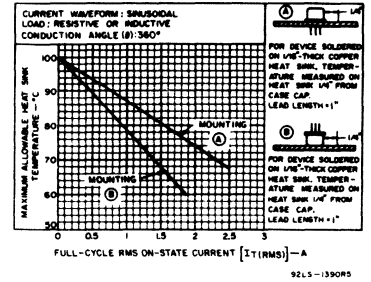


Fig. 4—Maximum allowable heat-sink temperature vs. on-state current for T2300, T2301, T2302 series.

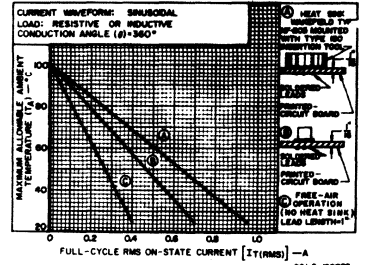


Fig. 5—Maximum allowable ambient temperature vs. on-state current for T2302 series.

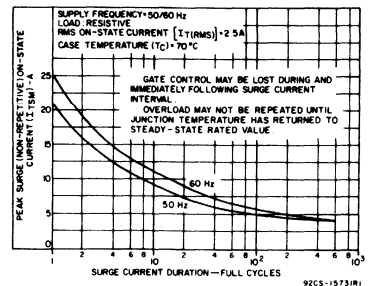


Fig. 6—Peak surge on-state current vs. surge-current duration.

T2300, T2301, T2302, T2310, T2311, T2312 Series

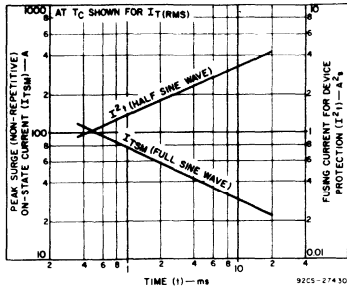


Fig. 7—Peak surge on-state current and fusing current vs. time.

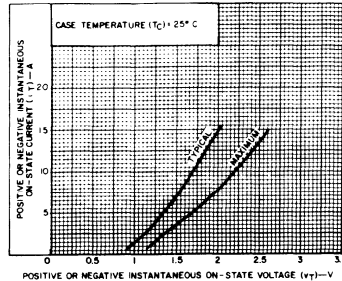


Fig. 8—On-state current vs. on-state voltage for all standard series.

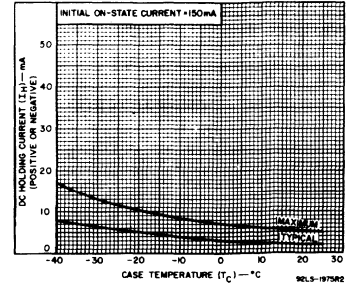


Fig. 9—DC holding current (positive or negative) vs. case temperature for T2300, T2301, T2310, T2311 series.

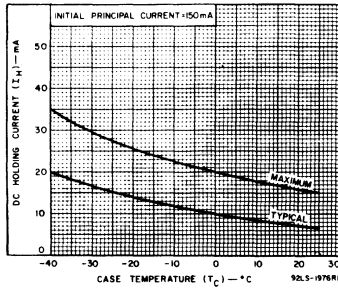


Fig. 10—DC holding current (positive or negative) vs. case temperature for T2302, T2312 series.

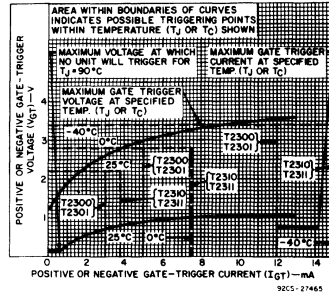


Fig. 11—Gate-trigger voltage vs. gate-trigger current for T2300, T2301, T2310, T2311 series.

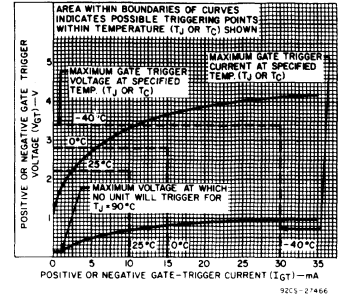


Fig. 12—Gate-trigger voltage vs. gate-trigger current for T2302, T2312 series.

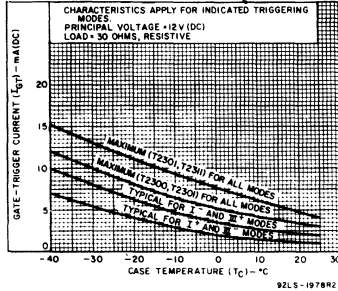


Fig. 13—Gate-trigger current vs. case temperature for T2300, T2301.

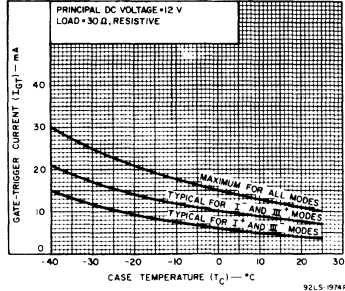


Fig. 14—Gate-trigger current vs. case temperature for T2302, T2312 series.

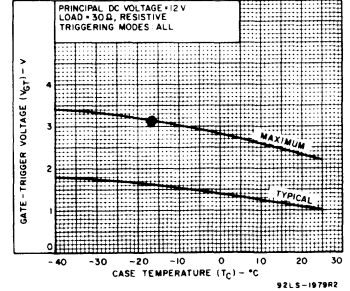


Fig. 15—Gate-trigger voltage vs. case temperature.

T2303 (2N5754-2N5757), T2313 Series

2.5-A Silicon Triacs

Modified TO-5 and Modified TO-5 with Heat Radiator Packages For AC power Switching Applications

The RCA-T2303 and T2313 series triacs are gate-controlled full-wave silicon ac switches that are designed to switch from an off-state to an on-state for either polarity of applied voltage with positive or negative gate-triggering voltages.

The T2303 (2N5754-57) series types employ a hermetic modified TO-5 package. The T2313 series types employ a hermetic modified TO-5 with a factory-attached heat radiator package.

Features:

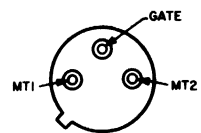
- Gate sensitivity -25 mA
- di/dt capability -100 A/ μ s
- Shorted-emitter, center-gate design
- Low switching losses
- Low-on-state voltage at high current levels

MAXIMUM RATINGS, Absolute-Maximum Values:

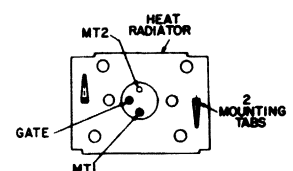
For operation with sinusoidal supply voltage at frequencies up to 50/60 Hz and with resistive or inductive load

	T2303F T2313F	2N5754 T2313A	2N5755 T2313B	2N5756 T2313D	2N5757 T2313M	
V_{DROM}^{Δ} Gate open, $T_J = -65$ to $100^{\circ}C$	50	100	200	400	600	V
$I_{T(RMS)}$ ($\theta = 360^{\circ}C$)			2.5			A
$T_A = 70^{\circ}C$ (T2303 series)			1.9			A
$T_A = 25^{\circ}C$ (T2313 series)						
For other conditions			See Figs. 2,3,4			
I_{TSM} For one cycle of applied principal voltage, at current and temperature shown above for $I_{T(RMS)}$:						
60 Hz (sinusoidal)			25			A
50 Hz (sinusoidal)			21			A
For more than one cycle of applied principal voltage			See Figs. 5,6			
di/dt: $V_D = V_{DROM}$, $I_{GT} = 50$ mA, $t_r = 0.1 \mu s$ I_{T1} (At T_C shown for $I_{T(RMS)}$):			100			A/ μ s
$t = 20$ ms			4.3			A $_2^1$
$t = 2.9$ ms			2			A $_2^2$
$t = 0.5$ ms			1			A $_2^3$
For other time values			See Fig. 6			
I_{GTM}^{\bullet} For 1 μs max. (See Fig. 9)			1			A
P_{GM} Peak (For 1 μs max., $I_{GTM} \leq 1$ A (peak), (See Fig. 9)			10			W
$P_{(IAV)}$ - $T_C = 70^{\circ}C$			0.15			W
$T_A = 25^{\circ}C$			0.05			W
T_J			-65 to 150			$^{\circ}C$
T_C			-65 to 100			$^{\circ}C$
During soldering for 10 s maximum at distance $\geq 1/16$ in. (1.58 mm) from seating plane			225			$^{\circ}C$

TERMINAL CONNECTIONS



92CS-2772B
T2303 (2N5754-57) Series



92CS-2772S
T2313 Series

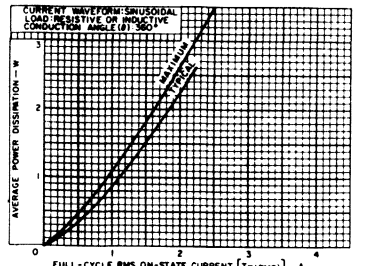


Fig. 1 - Power dissipation vs. on-state current.

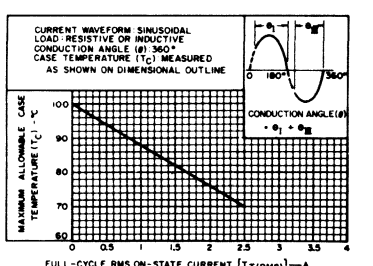


Fig. 2 - Maximum allowable case temperature vs. on-state current.

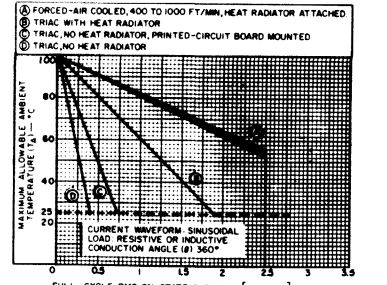


Fig. 3 - Maximum allowable ambient temperature vs. on-state current.

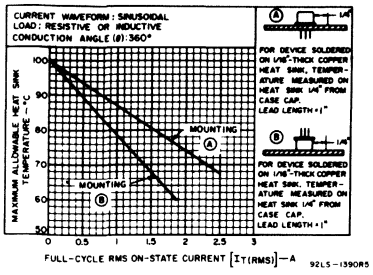


Fig. 4 - Maximum allowable heat-sink temperature vs. on-state current.

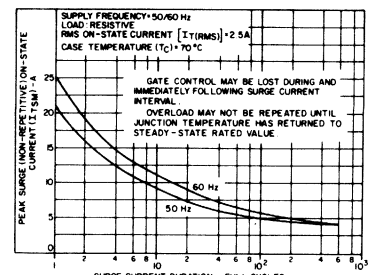


Fig. 5 - Peak surge on-state current vs. surge-current duration.

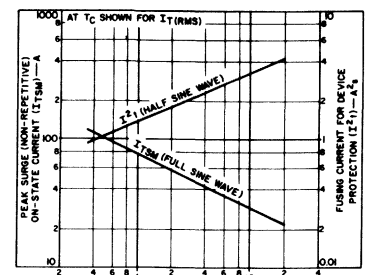


Fig. 6 - Peak surge on-state current and fusing current vs. time.

T2303 (2N5754-2N5757), T2313 Series

ELECTRICAL CHARACTERISTICS, At Maximum Ratings Unless Otherwise Specified and at Indicated Case Temperature (T_C)

CHARACTERISTICS	LIMITS			UNITS
	For All Types Except as Specified			
	MIN.	TYP.	MAX.	
I_{DROM}^{Δ} : Gate open, $T_J = 100^{\circ}C$, $V_{DROM} = \text{Max. rated value}$	—	0.2	0.75	mA
V_{TM}^{Δ} : $i_T = 10 \text{ A (peak)}$, $T_C = 25^{\circ}C$	—	2.2	2.6	V
$i_T = 3.5 \text{ A (peak)}$, $T_C = 25^{\circ}C$	—	—	1.8	
I_{HO}^{Δ} : (See Fig. 7) Gate open, Initial principal current = 150 mA (dc), $v_D = 12 \text{ V}$ $T_C = 25^{\circ}C$	—	6	35	mA
$T_C = -65^{\circ}C$	—	20	82*	
dv/dt (Commutating) $^{\Delta}$: $v_D = V_{DROM}$, $I_T(\text{RMS}) = 2.5 \text{ A}$ commutating $di/dt = 0.95 \text{ A/ms}$, gate unenergized, $T_C = 70^{\circ}C$	0.5	—	—	V/ μ s
dv/dt (Off-State) $^{\Delta}$: $v_D = V_{DROM}$, exponential voltage rise, gate open, $T_C = 100^{\circ}C$:	10	100	—	V/ μ s
$I_{GT}^{\Delta\bullet}$: (See Fig. 10) $v_D = 12 \text{ V dc}$, $R_L = 30 \Omega$, $T_C = 25^{\circ}C$ Mode V_{MT2} V_G I ⁺ positive positive	—	5	25	mA
III ⁻ negative negative	—	5	25	
I ⁻ positive negative	—	10	40	
III ⁺ negative positive	—	10	40	
$v_D = 12 \text{ V dc}$, $R_L = 30 \Omega$, $T_C = -65^{\circ}C$ Mode V_{MT2} V_G I ⁺ positive positive	—	30	60*	
III ⁻ negative negative	—	30	60*	
I ⁻ positive negative	—	40	100*	
III ⁺ negative positive	—	40	100*	
$V_{GT}^{\Delta\bullet}$: (See Fig. 11) $v_D = 12 \text{ V dc}$, $R_L = 30 \Omega$, $T_C = 25^{\circ}C$	—	0.9	2.2	V
$T_C = -65^{\circ}C$	—	1.5	3*	
$v_D = V_{DROM}$, $R_L = 125 \Omega$, $T_C = 100^{\circ}C$	0.2	—	—	
t_{gt} : $v_D = V_{DROM}$, $I_{GT} = 60 \text{ mA}$, $t_r = 0.1 \mu\text{s}$, $i_T = 10 \text{ A (peak)}$, $T_C = 25^{\circ}C$	—	1.8	2.5	μs
$R_{\theta JC}$: Steady-State	—	—	8.5	$^{\circ}C/W$
$R_{\theta JA}$: Steady-State	—	—	150	

* In accordance with JEDEC registration data format (JS-14, RDF-2— filed for the JEDEC (2N-Series) types.
 Δ For either polarity of main terminal 2 voltage (V_{MT2}) with reference to main terminal 1.
 \bullet For either polarity of gate voltage (V_G) with reference to main terminal 1.

T2303 (2N5754-2N5757), T2313 Series

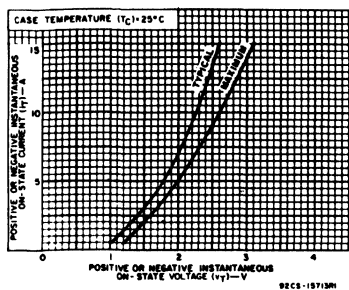


Fig. 7 — On-state current vs. on-state voltage.

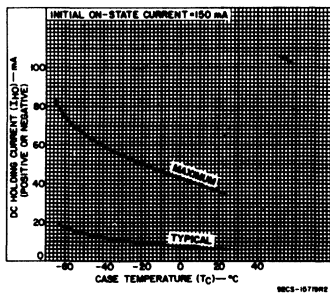


Fig. 8 — DC holding current (positive or negative) vs. case temperature.

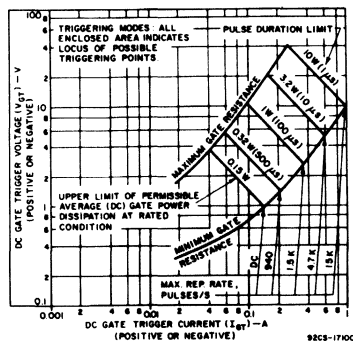


Fig. 9 — Gate-trigger characteristics and limiting conditions for determination of permissible gate-trigger pulses.

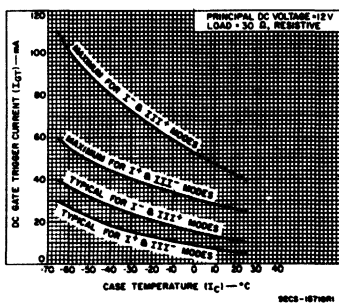


Fig. 10 — DC gate-trigger current vs. case temperature.

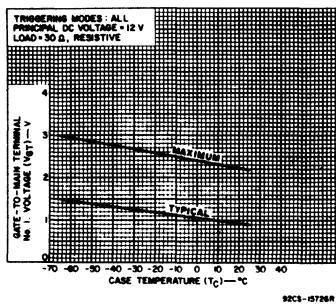


Fig. 11 — DC gate-trigger voltage vs. case temperature.

T2304, T2305 Series

400-Hz, 0.5A Sensitive-Gate Silicon Triacs

For Control-Systems Application in Airborne and Ground-Support Type Equipment

RCA T2304- and T2305-series triacs are gate-controlled full-wave silicon ac switches. They are designed to switch from an off-state to an on-state for either polarity of applied voltage with positive or negative gate triggering voltages.

These triacs are intended for operation up to 400 Hz with resistive or inductive loads and nominal line voltages of 115

and 208 V RMS sine wave and repetitive peak off-stage voltages of 200 V and 400 V.

The high gate sensitivity of these triacs permits the use of economical transistorized or integrated control circuits and enhances their use in low-power phase control and load-switching applications.

Features:

- High gate sensitivity, $I_{GT} = 10/40$ mA max.
- di/dt capability = 100 A/ μ s
- Commutating dv/dt capability characterized at 400 Hz
- Shorted-Emitter Design

MAXIMUM RATINGS, Absolute-Maximum Values:

For Operation with Sinusoidal Supply Voltage at Frequencies up to 400 Hz and with Resistive or Inductive Load.

	T2304B	T2304D	T2305B	T2305D
REPETITIVE PEAK OFF-STATE VOLTAGE: [*] Gate open, $T_J = -50$ to 100°C	V_{DROM}	200	400	V
RMS ON-STATE CURRENT (Conduction angle = 360°): Case temperature (T_C) = 90°C Ambient temperature (T_A) = 25°C , without heat sink	$I_{T(RMS)}$	0.5	0.4	A
For other conditions		See Figs. 2 & 3		
PEAK SURGE (NON-REPEITIVE) ON-STATE CURRENT: For one cycle of applied principal voltage, $T_C = 90^\circ\text{C}$	I_{TSM}	50	25	A
400 Hz (sinusoidal)		25	21	A
60 Hz (sinusoidal)		21		A
50 Hz (sinusoidal)				A
For more than one cycle of applied principal voltage		See Fig. 4		
RATE-OF-CHANGE OF ON-STATE CURRENT: $V_{DM} = V_{DROM}$, $I_{GT} = 60$ mA, $t_r = 0.1$ μ s	di/dt	100		A/ μ s
FUSING CURRENT (for triac protection): $T_J = -50$ to 100°C , $t = 1.25$ to 10 ms	I^2t	2		A ² s
PEAK GATE-TRIGGER CURRENT: ^{**} For 1 μ s (max.) (See Fig. 10)	I_{GTM}	1		A
GATE POWER DISSIPATION: PEAK (For 1 μ s max., See Fig. 10)	P_{GM}	10		W
AVERAGE (At $T_C = 60^\circ\text{C}$)	$P_{G(AV)}$	0.15		W
(At $T_A = 25^\circ\text{C}$, without heat sink)	$P_{G(AV)}$	0.05		W
TEMPERATURE RANGE: [▲] Storage	T_{stg}	-50 to 150		$^\circ\text{C}$
Operating (Case)	T_C	-50 to 100		$^\circ\text{C}$
LEADTEMPERATURE (During soldering): At distances $\geq 1/16$ in. (1.58 mm) from the case for 10 s max.	T_L	225		$^\circ\text{C}$

- * For either polarity of main terminal 2 voltage (V_{MT2}) with reference to main terminal 1.
- ** For either polarity of gate voltage (V_G) with reference to main terminal 1.
- ▲ For temperature measurement reference point, see Dimensional Outline.

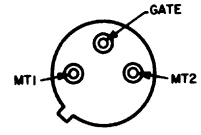
ELECTRICAL CHARACTERISTICS

At Maximum Ratings and at Indicated Case Temperature (T_C) Unless Otherwise Specified

CHARACTERISTIC	SYMBOL	LIMITS						UNITS	
		T2304 Series			T2305 Series				
		Min.	Typ.	Max.	Min.	Typ.	Max.		
Peak Off-State Current: [♠] Gate open, $T_J = 100^\circ\text{C}$, $V_{DROM} = \text{Max. rated value}$	I_{DROM}	-	0.2	0.75	-	0.2	0.75	mA	
Maximum On-State Voltage: [♠] For $I_T = 10$ A (peak), $T_C = 25^\circ\text{C}$	V_{TM}	-	1.7	2.2	-	1.7	2.2	V	
DC Holding Current: [♠] Gate open, Initial principal current = 150 mA (DC), $v_D = 12$ V, $T_C = 25^\circ\text{C}$ For other case temperatures	I_{HO}	-	7	15	-	15	30	mA	
Critical Rate-of-Rise of Commutation Voltage: [♠] For $v_D = V_{DROM}$, $I_T(RMS) = 0.5$ A, commutating $di/dt = 1.8$ A/ms, gate unenergized, $T_C = 90^\circ\text{C}$	dv/dt	See Figs. 8 & 9						V/ μ s	
Critical Rate-of-Rise of Off-Stage Voltage: [♠] For $v_D = V_{DROM}$, exponential voltage rise, gate open, $T_C = 100^\circ\text{C}$	dv/dt	10	100	-	10	100	-	V/ μ s	
DC Gate-Trigger Current: [♠] For $v_D = 12$ V (DC), $R_L = 30 \Omega$, $T_C = 25^\circ\text{C}$ For other case temperatures	Mode I_{GT}	V_{MT2} positive negative positive negative	V_G positive negative negative positive	-	3.5 3.5 7 7	10 10 10 10	5 5 10 10	25 25 40 40	mA
DC Gate-Trigger Voltage: ^{♠†} For $v_D = 12$ V (DC), $R_L = 30 \Omega$, $T_C = 25^\circ\text{C}$ For other case temperatures For $v_D = V_{DROM}$, $R_L = 125 \Omega$, $T_C = 100^\circ\text{C}$	V_{GT}	See Figs. 11 & 12						V	
Gate-Controlled Turn-On Time: (Delay Time + Rise Time) For $v_D = V_{DROM}$, $I_{GT} = 60$ mA, $t_r = 0.1 \mu$ s, $I_T = 10$ A (peak), $T_C = 25^\circ\text{C}$ (See Fig. 16)	t_{gt}	See Fig. 13						μ s	
Thermal Resistance, Junction-to-Case:	θ_{JC}	-	-	8.5	-	-	8.5	$^\circ\text{C/W}$	

- ♠ For either polarity of main terminal 2 voltage (V_{MT2}) with reference to main terminal 1.
- † For either polarity of gate voltage (V_G) with reference to main terminal 1.

TERMINAL CONNECTIONS



92CS-27728
Modified JEDEC TO-5

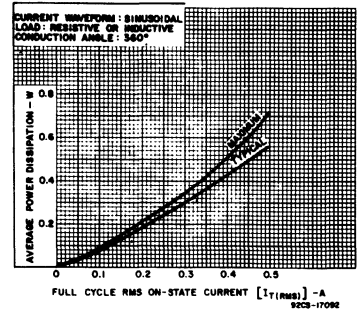


Fig. 1—Power dissipation vs. on-state current.

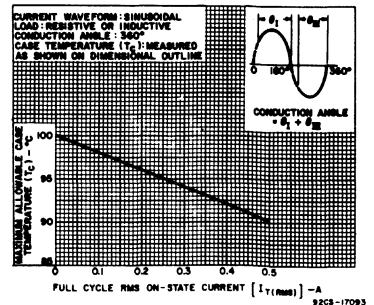


Fig. 2—Maximum allowable case temperature vs. on-state current.

T2304, T2305 Series

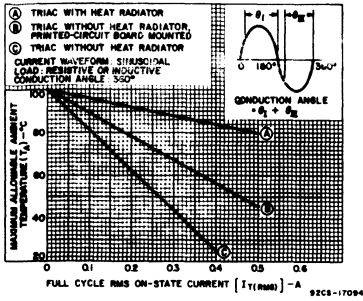


Fig. 3—Maximum allowable ambient temperature vs. on-state current for the package/mounting options of these triacs.

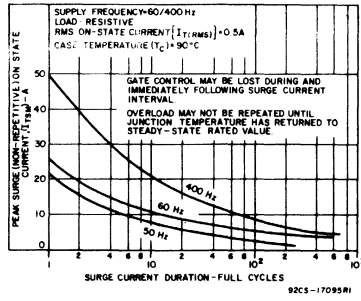


Fig. 4—Peak surge on-state current vs. surge-current duration.

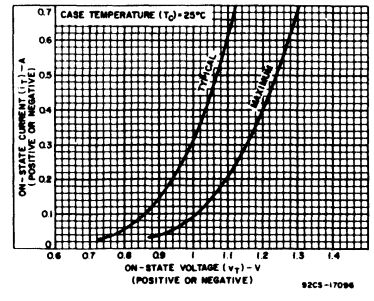


Fig. 5—On-state current vs. on-state voltage (steady-state condition).

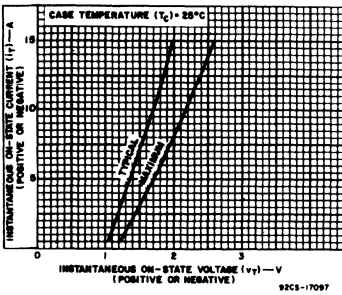


Fig. 6—On-state current vs. on-state voltage (surge condition).

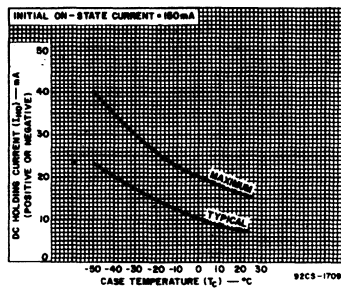


Fig. 7—DC holding current vs. case temperature for T2304 series.

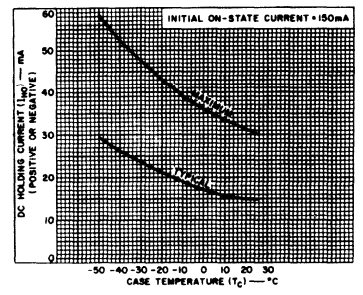


Fig. 8—DC holding current vs. case temperature for T2305 series.

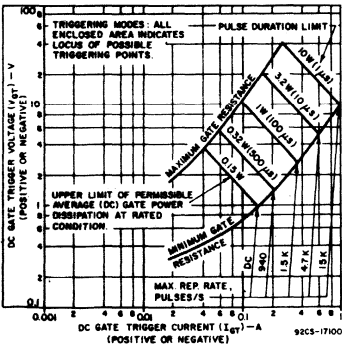


Fig. 9—Gate-trigger characteristics and limiting conditions for determination of permissible gate-trigger pulses.

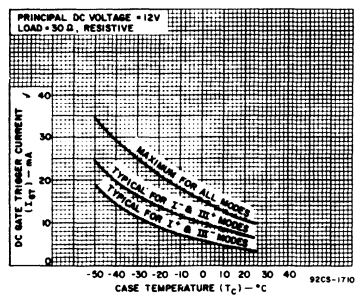


Fig. 10—DC gate-trigger current vs. case temperature for T2304 series.

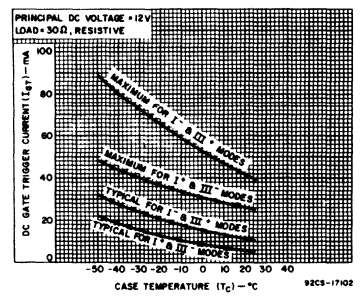


Fig. 11—DC gate-trigger current vs. case temperature for T2305 series.

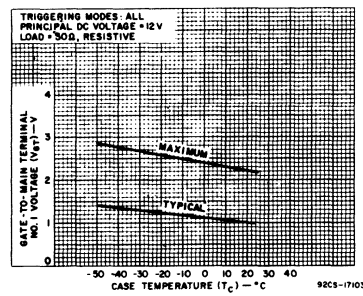


Fig. 12—DC gate-trigger voltage vs. case temperature.

T2320, T2322, T2323, T2327 Series

2.5-A Sensitive-Gate Silicon Triacs

For AC Power Switching

The RCA-T2320, T2322, T2323 and T2327, series triacs are gate-controlled full-wave silicon ac switches that are designed to switch from an off-state to an on-state for either polarity of applied voltage with positive or negative gate triggering voltages.

The gate sensitivity of these triacs permits the use of economical transistorized or integrated circuit control circuits and enhances their use in low-power phase-control and load-switching applications.

All types in each series utilize the JEDEC-TO-202AB (RCA VERSATAB) plastic package.

MAXIMUM RATINGS, Absolute-Maximum Values:

For Operation with Sinusoidal Supply Voltage at Frequencies Up to 50/60 Hz and with Resistive or Inductive Load

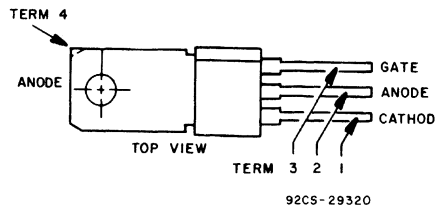
	3 mA Gate	T2320F	T2320A	T2320B	T2320C	T2320D	T2320E
V_{DROM}^{Δ}	10 mA Gate	T2322F	T2322A	T2322B	T2322C	T2322D	T2322E
Gate open, $T_J = -40$ to $100^{\circ}C$	25 mA Gate	T2327F	T2327A	T2327B	T2327C	T2327D	T2327E
$I_T(RMS)$ ($\theta = 360^{\circ}$):							
$T_C = 70^{\circ}C$				2.5			A
$T_A = 25^{\circ}C$				0.8			A
For other conditions				See Figs. 3 and 4			
I_{TSM}^{\bullet} :							
For one full cycle of applied principal voltage, at current and temperature shown above for $I_T(RMS)$:							
60 Hz (sinusoidal)				25			A
50 Hz (sinusoidal)				23.5			A
For more than one cycle of applied principal voltage				See Fig.5			
di/dt:							
$V_D = V_{DROM} \cdot I_{GT} = 50$ mA,							
$t_r = 0.1 \mu s$ (See Fig. 10)				100			A/ μs
$i^2 t$ [At T_C shown for $I_T(RMS)$] (Half-sine wave):							
$t = 20$ ms				3.4			A ² s
$t = 2.5$ ms				1.7			A ² s
$t = 0.5$ ms				1			A ² s
For other time values				See Fig.6			
I_{GTM}^{\bullet} :							
For 1 μs max.				1			A
P_{GM}^{\bullet} :							
Peak (For 1 μs max.,							
$I_{GTM} \leq 1$ A(peak)				10			W
$P_G(AV)$:							
$T_C = 60^{\circ}C$				0.1			W
$T_A = 25^{\circ}C$				0.05			W
T_{stg}^{\bullet}				-40 to 150			$^{\circ}C$
T_C				-40 to 100			$^{\circ}C$
T_T^{\bullet} :							
During soldering for 10 s maximum at distance $\geq 1/16$ in. (1.58 mm) from seating plane				225			$^{\circ}C$

- Δ For either polarity of main terminal 2 voltage (V_{MT2}) with reference to main terminal 1.
- \bullet For either polarity of gate voltage (V_G) with reference to main terminal 1.
- \bullet For temperature measurement reference point, see Dimensional Outlines.

Features:

- Very high gate sensitivity—3.5 and 10 mA
- di/dt capability—100 A/ μs
- Shorted-emitter, center-gate design
- Low switching losses
- Low on-state voltage at high current levels
- Glass-passivated chip for stability
- Package and formed-lead options available

TERMINAL CONNECTIONS



JEDEC TO-202AB (Type 1 Package)

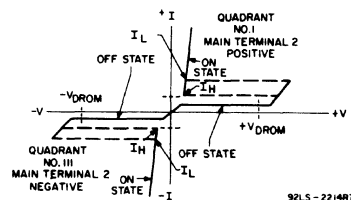


Fig. 1 - Principal voltage-current characteristic.

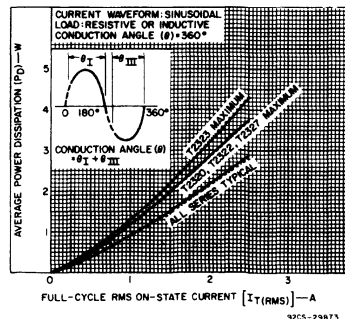


Fig. 2 - Power dissipation as a function of on-state current.

T2320, T2322, T2323, T2327 Series

ELECTRICAL CHARACTERISTICS

At Maximum Ratings Unless Otherwise Specified and at Indicated Case Temperature (T_C)

CHARACTERISTIC	LIMITS			UNITS
	FOR ALL TYPES Except as Specified			
	Min.	Typ.	Max.	
I_{DROM}^{Δ} : Gate open, $T_J = 100^{\circ}C$, $V_{DROM} = \text{Max. rated value}$	—	0.2	0.75	mA
V_{TM}^{Δ} : $i_T = 10 \text{ A(peak)}$, $T_C = 25^{\circ}C$ T2320, T2322, T2327 series $i_T = 10 \text{ A(peak)}$, $T_C = 25^{\circ}C$ T2323 series	—	1.7	2.2	V
I_{HO}^{Δ} : Gate open, Initial principal current = 150 mA (dc), $v_D = 12 \text{ V}$, $T_C = 25^{\circ}C$	—	15	30	mA
dv/dt (Commutating) $^{\Delta}$: $v_D = V_{DROM}$, $i_T(\text{RMS}) = 2.5 \text{ A}$, commutating $di/dt = 1.8 \text{ A/ms}$, gate unenergized, $T_C = 90^{\circ}C$	1	4	—	V/ μ s
dv/dt (Off-state) $^{\Delta}$: $v_D = V_{DROM}$, exponential voltage rise, gate open, $T_C = 100^{\circ}C$	10	100	—	
I_{GT}^{Δ} : $v_D = 12 \text{ V dc}$, $R_L = 30 \Omega$, $T_C = 25^{\circ}C$ (See Fig. 8)				
Mode V_{MT2} V_G				
I ⁺ positive positive				
T2320 series	—	—	3	
T2322 series	—	—	10	
T2323 series	—	—	25	
T2327 series	—	—	5	
III ⁻ negative negative				
T2320 series	—	—	3	
T2322 series	—	—	10	
T2323 series	—	—	25	
T2327 series	—	—	5	
I ⁻ positive negative				
T2320 series	—	—	3	
T2322 series	—	—	10	
T2323 series	—	—	40	
T2327 series	—	—	5	
III ⁺ negative positive				
T2320 series	—	—	3	
T2322 series	—	—	10	
T2323 series	—	—	40	
T2327 series	—	—	5	
V_{GT}^{Δ} : $v_D = 12 \text{ V dc}$, $R_L = 30 \Omega$, $T_C = 25^{\circ}C$ (See Fig. 9) $v_D = V_{DROM}$, $R_L = 125 \Omega$, $T_C = 100^{\circ}C$	—	1	2.2	V
t_{gt} : $v_D = V_{DROM}$, $I_{GT} = 60 \text{ mA}$, $t_r = 0.1 \mu\text{s}$, $i_T = 10 \text{ A(peak)}$, $T_C = 25^{\circ}C$	—	1.8	2.5	μs
$R_{\theta JC}$ (Package Types 1, 11, 12, 3, 32)	—	—	8	$^{\circ}C/W$
$R_{\theta JA}$ (Package Types 1, 11, 12, 3, 32)	—	—	80	
$R_{\theta JL}$ (Package Types 2, 21)	—	—	50	
$R_{\theta JA}$ (Package Types 2, 21)	—	—	100	

Δ For either polarity of main terminal 2 voltage (V_{MT2}) with reference to main terminal 1.
 \bullet For either polarity of gate voltage (V_G) with reference to main terminal 1.

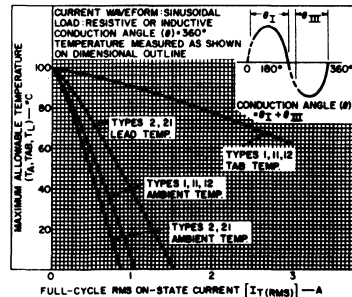


Fig. 3 - Maximum allowable temperature as a function of on-state current for T2320, T2322, and T2327.

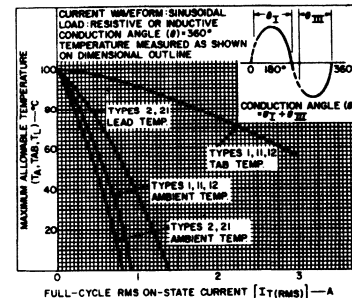


Fig. 4 - Maximum allowable temperature as a function of on-state current for T2323.

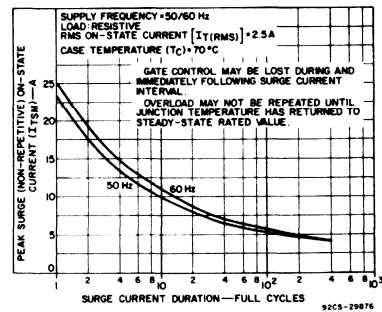


Fig. 5 - Peak surge on-state current as a function of surge-current duration.

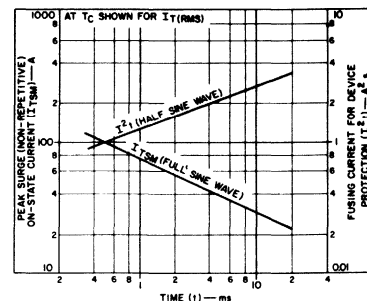


Fig. 6 - Peak surge on-state current and fusing current as a function of time.

T2320, T2322, T2323, T2327 Series

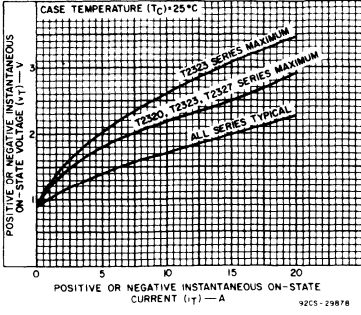


Fig. 7 - On-state current as a function of on-state voltage.

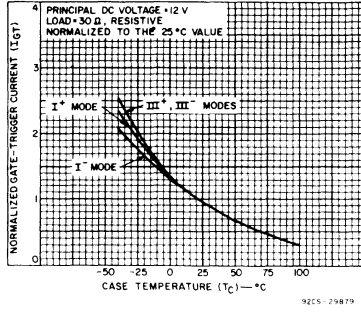


Fig. 8 - Gate-trigger current as a function of case temperature.

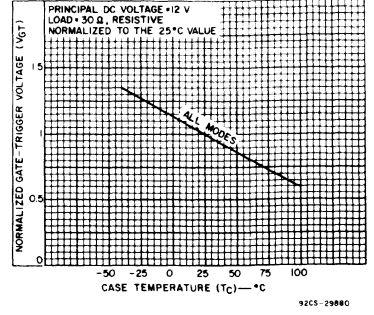


Fig. 9 - Gate trigger voltage as a function of case temperature.

T2500 Series

6-A Silicon Triacs

Three-Lead Plastic Types for Power-Control and Power-Switching Applications

Types T2500B and T2500D* are gate-controlled full-wave silicon triacs utilizing a plastic case with three leads to facilitate mounting on printed-circuit boards. They are intended for the control of ac loads in such applications as motor controls, heating controls, relay replacement, solenoid drivers, static switching, and power-switching systems.

These devices are designed to switch from an off-state to an on-state for either polarity of applied voltage with positive or

negative gate triggering voltages. They have an on-state current rating of 6 amperes at a T_C of 80°C and repetitive off-state voltage ratings of 200 volts and 400 volts, respectively.

These triacs employ the plastic JEDEC TO-220-AB package.

*Formerly RCA Dev. Nos. TA8504 and TA8506.

MAXIMUM RATINGS, Absolute-Maximum Values:

For Operation with Sinusoidal Supply Voltage at Frequencies up to 50/60 Hz and with Resistive or Inductive Load.

REPETITIVE PEAK OFF-STATE VOLTAGE:*

Gate open, $T_J = -65$ to 100°C

RMS ON-STATE CURRENT (Conduction angle = 360°)

Case temperature

$T_C = 80^\circ\text{C}$

For other conditions

PEAK SURGE (NON-REPETITIVE) ON-STATE CURRENT:

For one cycle of applied principal voltage, $T_C = 80^\circ\text{C}$

60 Hz (sinusoidal)

50 Hz (sinusoidal)

For more than one cycle of applied principal voltage

RATE OF CHANGE OF ON-STATE CURRENT:

$V_{DM} = V_{DROM}$; $I_{GT} = 200$ mA, $t_r = 0.1 \mu\text{s}$

FUSING CURRENT (for Triac Protection):

$T_C = -65$ to 100°C, $t = 1.25$ to 10 ms

PEAK GATE-TRIGGER CURRENT:*

For 10 μs max; see Fig. 10

GATE POWER DISSIPATION:

Peak (For 1 μs max., $I_{GTM} \leq 4$ A; see Fig. 6)

AVERAGE

TEMPERATURE RANGE:*

Storage

Operating (Case)

TERMINAL TEMPERATURE (During soldering):

For 10 s max. (terminals and case)

• For either polarity of main terminal 2 voltage (V_{MT2}) with reference to main terminal 1.

• For either polarity of gate voltage (V_G) with reference to main terminal 1.

• For temperature measurement reference point, see Dimensional Outline.

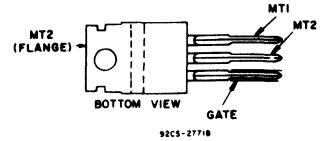
ELECTRICAL CHARACTERISTICS at Maximum Ratings unless otherwise specified, and at indicated Case Temperature (T_C)

CHARACTERISTIC	SYMBOL	LIMITS						UNITS
		T2500B			T2500D			
		MIN.	TYP.	MAX.	MIN.	TYP.	MAX.	
Peak Off-State Current: Gate Open, $V_{DROM} =$ Max. rated value At $T_J = 100^\circ\text{C}$	I_{DROM}	-	0.1	2	-	0.1	2	mA
Maximum On-State Voltage: For $i_T = 30$ A (peak) and $T_C = 25^\circ\text{C}$	V_{TM}	-	1.7	2	-	1.7	2	V
DC Holding Current: Gate Open Initial principal current = 150 mA (dc) At $T_C = 25^\circ\text{C}$ For other case temperatures	I_{HO}	-	15	30	-	15	30	mA
Critical Rate of Rise of Commutation Voltage: For $v_D = V_{DROM}$, $I_T(\text{RMS}) = 6$ A, Commutating $di/dt = 3.2$ A/ms, and gate unenergized At $T_C = 80^\circ\text{C}$	dv/dt	4	10	-	4	10	-	V/ μs
Critical Rate of Rise of Off-State Voltage: For $v_D = V_{DROM}$ exponential voltage rise, and gate open At $T_C = 100^\circ\text{C}$ For other case temperatures	dv/dt	100	300	-	75	250	-	V/ μs
DC Gate-Trigger Current: For $v_D = 12$ V (dc), $R_L = 12 \Omega$ $T_C = 25^\circ\text{C}$, and specified triggering mode: I^+ Mode (V_{MT2} positive, V_G positive) I^- Mode (V_{MT2} negative, V_G negative) I^+ Mode (V_{MT2} positive, V_G negative) I^- Mode (V_{MT2} negative, V_G positive) For other case temperatures	I_{GT}	-	10	25	-	10	25	mA

Features:

- 60-A Peak Surge Full-Cycle Current Ratings
- Shorted-Emitter, Center-Gate Design
- Package Design Facilitates Mounting on a Printed-Circuit Board
- Low Switching Losses
- Low Thermal Resistance

TERMINAL CONNECTIONS



**BOTTOM VIEW
JEDEC TO-220AB**

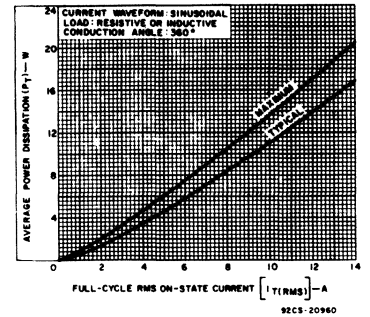


Fig. 1—Power dissipation vs. on-state current.

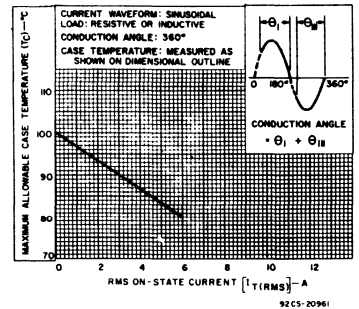


Fig. 2—Allowable case temperature vs. on-state current.

T2500 Series

ELECTRICAL CHARACTERISTICS at Maximum Ratings unless otherwise specified, and at indicated Case Temperature (T_C)

CHARACTERISTIC	SYMBOL	LIMITS						UNITS
		T2500B			T2500D			
		MIN.	TYP.	MAX.	MIN.	TYP.	MAX.	
DC Gate-Trigger Voltage: ¹ For $V_D = 12V$ (dc) and $R_L = 12\Omega$ At $T_C = 25^\circ C$ For other case temperatures For $V_D = V_{DROM}$ and $R_L = 125\Omega$ At $T_C = 100^\circ C$	V_{GT}	0.2	1.25	2.5	0.2	1.25	2.5	V
Gate-Controlled Turn-On Time (Delay Time + Rise Time): For $V_D = V_{DROM}$, $I_{GT} = 160$ mA, rise time = $0.1 \mu s$, and $i_T = 10$ A (peak) At $T_C = 25^\circ C$	t_{gt}	-	1.6	2.5	-	1.5	2.5	μs
Thermal Resistance: Junction-to-Case	$R_{\theta JC}$	-	-	2.7	-	-	2.7	$^\circ C/W$
Junction-to-Ambient	$R_{\theta JA}$	-	-	60	-	-	60	$^\circ C/W$

¹For either polarity of main terminal 2 voltage (V_{M12}) with reference to main terminal 1.

²For either polarity of gate voltage (V_G) with reference to main terminal 1.

³Variants of these devices having dv/dt characteristics selected specifically for inductive loads are available on special order; for additional information, contact your RCA Representative or your RCA Distributor.

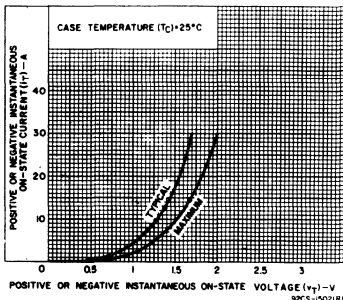


Fig. 4—On-state current vs. on-state voltage.

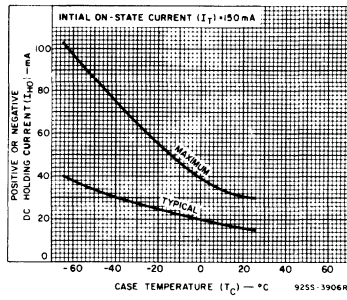


Fig. 5—DC holding current for either direction of on-state current vs. case temperature.

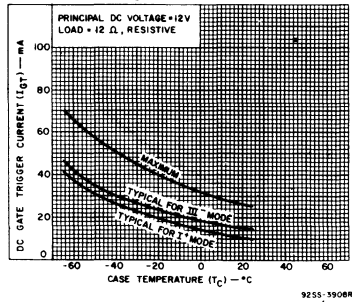


Fig. 7—DC gate-trigger current (for I^+ and III^+ triggering modes) vs. case temperature.

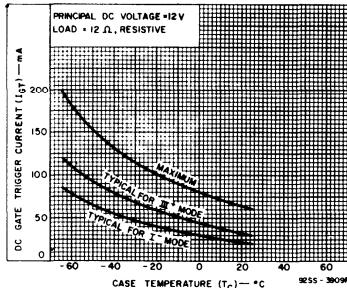


Fig. 8—DC gate-trigger current (for I^- and III^+ triggering modes) vs. temperature.

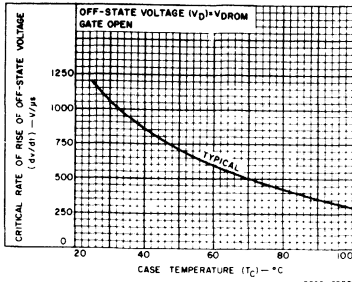


Fig. 10—Critical rate of rise of off-state voltage vs. case temperature.

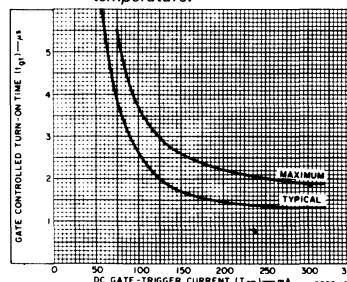


Fig. 11—Typical turn-on time vs. gate-trigger current.

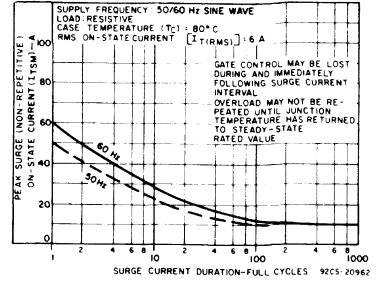


Fig. 3—Peak surge on-state current vs. surge-current duration.

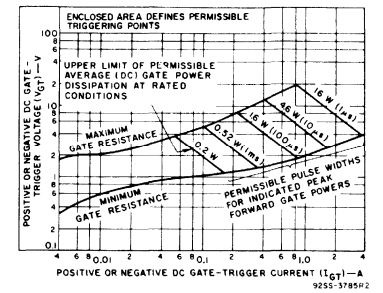


Fig. 6—Gate-pulse characteristics for all triggering modes.

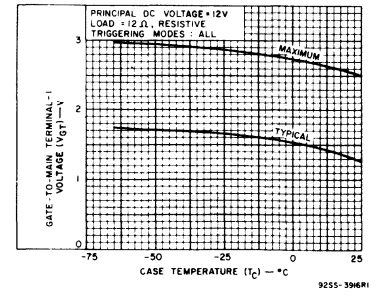


Fig. 9—DC gate-trigger voltage vs. case temperature.

T2700, T2710 Series

6-A Silicon Triacs

For Power-Control and Power-Switching Applications

RCA T2700- and T2710-series devices are gate-controlled full-wave silicon triacs. They are intended for the control of ac loads in applications such as heating controls, motor controls, light dimmers, and power switching systems.

These triacs are designed to switch from an off-state to an on-state condition for either polarity of applied voltage with positive or negative triggering voltages to the gate.

Features:

- Shorted-emitter construction
- ... contains an internally diffused resistor between gate and Main Terminal 1

T2700B and T2700D are hermetically sealed types having an on-state current rating of 6 amperes at a case temperature of +75°C and repetitive off-state voltage ratings of 200 volts and 400 volts, respectively.

The T2700 series types employ the hermetic JEDEC TO-66 package. The T2710 series employ the hermetic TO-66 with a factory attached heat-radiator package.

Maximum Ratings, Absolute-Maximum Values:

For Operation with Sinusoidal Supply Voltage at Frequencies of 50/60 Hz, and with Resistive or Inductive Load

REPETITIVE PEAK OFF-STATE VOLTAGE*, V_{DROM} : T2700B T2700D T2710B T2710D

Gate Open, For $T_J = -65$ to $+100$ °C 200 400 V

RMS ON-STATE CURRENT, $I_{T(rms)}$:

For case temperature (T_C) of +75 °C and a conduction angle of 360° 6 6 A

For ambient temperatures (T_A) up to +100 °C and a conduction angle of 360° See Fig. 3.

PEAK SURGE (NON-REPEITIVE), ON-STATE CURRENT, I_{TSM} :

For one cycle of applied principal voltage, $T_C = 75$ °C

60 Hz (sinusoidal) 100 100 A
50 Hz (sinusoidal) 85 85 A

For more than one full cycle of applied voltage See Fig. 4.

RATE OF CHANGE OF ON-STATE CURRENT:

$V_{DM} = V_{DROM}$, $I_{GT} = 200$ mA, $t_r = 0.1$ μ s di/dt 100 A/ μ s

FUSING CURRENT (for triac protection, I_{T^2} , $T_J = -65$ to 100 °C, $t = 1.25$ to 10 ms 50 50 A²s

PEAK GATE-TRIGGER CURRENT \ddagger , I_{GTM} : For 1 μ s max. 4 4 A

GATE POWER DISSIPATION: $P_{G(AV)}$:

PEAK, P_{GM} For 1 μ s max. and $I_{GTM} \leq 4$ A (peak) 16 16 W

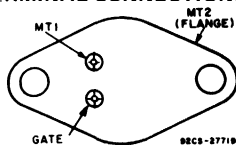
AVERAGE, $P_{G(AV)}$ 0.2 0.2 W

TEMPERATURE RANGE:

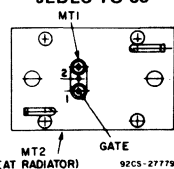
Storage -65 to $+150$ °C
Operating (case) -65 to $+100$ °C

- *For either polarity of main terminal 2 voltage (V_{MT2}) with reference to main terminal 1.
- \ddagger For either polarity of gate voltage (V_{GT}) with reference to main terminal 1.
- \ddagger For information on the reference point of temperature measurement, see Dimensional Outline.

TERMINAL CONNECTIONS



JEDEC TO-66



JEDEC TO-66 With Heat Radiator

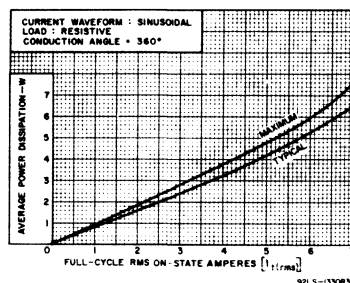


Fig. 1—Power dissipation vs. on-state current.

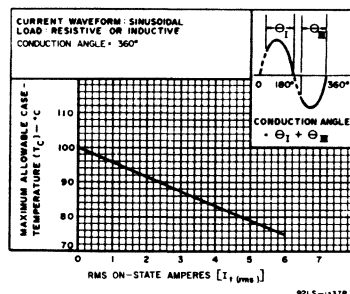


Fig. 2—Allowable case temperature vs. on-state current.

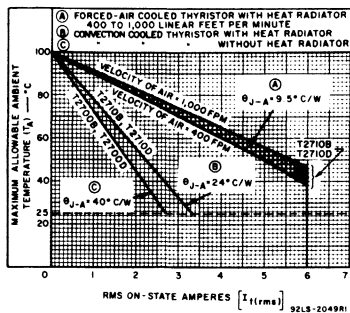


Fig. 3—Maximum allowable ambient temperature vs. on-state current.

ELECTRICAL CHARACTERISTICS

At Maximum Ratings and at Indicated Case Temperature (T_C) Unless Otherwise Specified (For Definitions of Terms and Symbols, See Page 6)

CHARACTERISTIC	SYMBOL	LIMITS						UNITS			
		T2700B		T2710B		T2710D					
		Min.	Typ.	Max.	Min.	Typ.	Max.	Min.	Typ.	Max.	
Peak Off-State Current* Gate Open At $T_J = -100$ °C and $V_{DROM} =$ Max. rated value	I_{DROM}	- 0.1	4	- 0.1	1.2	- 0.2	4	- 0.2	1.2		mA
Maximum On-State Voltage* For $i_T = 30$ A (peak) and $T_C = +25$ °C	V_{TM}	- 1.8	2.25	- 1.8	2.25	- 1.8	2.25	- 1.8	2.25		V
DC Holding Current* Gate Open Initial principal current = 150 mA (DC) At $T_C = +25$ °C For other case temperatures	I_{HO}	- 15	30	- 15	30	- 15	30	- 15	30		mA
Critical Rate of Rise of Commutation Voltage* For $V_D = V_{DROM}$, $I_{G(rms)} = 6$ A, commutating di/dt = 3.2 A/ms, and gate unenergized At $T_C = +75$ °C	dv/dt	3	10	-	-	3	10	-	-		V/ μ s
$I_{G(rms)}$ and T_A specified by curve A of Fig. 3		-	-	3	10	-	-	3	10		
$I_{G(rms)}$ and T_A specified by curve B of Fig. 3		-	-	4	12	-	-	4	12		
Critical Rate of Rise of Off-State Voltage* For $V_D = V_{DROM}$, exponential voltage rise, and gate open At $T_C = +100$ °C	dv/dt	30	150	- 30	150	- 20	100	- 20	100		V/ μ s
DC Gate-Trigger Current* For $V_D = 12$ volts (DC), $R_L = 12$ Ω $T_C = +25$ °C, and specified triggering mode: I- Mode: positive V_{MT2} , positive V_{GT} III- Mode: negative V_{MT2} , negative V_{GT} I+ Mode: positive V_{MT2} , negative V_{GT} III+ Mode: negative V_{MT2} , positive V_{GT} For other case temperatures	I_{GT}	- 15	25	- 15	25	- 15	25	- 15	25		mA
		- 15	25	- 15	25	- 15	25	- 15	25		
		- 25	40	- 25	40	- 25	40	- 25	40		
		- 25	40	- 25	40	- 25	40	- 25	40		
		See Fig. 8 & 9.									
DC Gate-Trigger Voltage* For $V_D = 12$ volts (DC) and $R_L = 12$ Ω At $T_C = +25$ °C For other case temperatures For $V_D = V_{DROM}$ and $R_L = 125$ Ω At $T_C = +100$ °C	V_{GT}	- 1	2.2	- 1	2.2	- 1	2.2	- 1	2.2		V
		See Fig. 10.									
		0.2	-	0.2	-	0.2	-	0.2	-		

T2700, T2710 Series

ELECTRICAL CHARACTERISTICS

At Maximum Ratings and at Indicated Case Temperature (T_C) Unless Otherwise Specified
(For Definitions of Terms and Symbols, See Page 6)

CHARACTERISTIC	SYMBOL	LIMITS										UNITS		
		T2700B			T2710B			T2700D			T2710D			
		Min.	Typ.	Max.	Min.	Typ.	Max.	Min.	Typ.	Max.	Min.	Typ.	Max.	
Gate-Controlled Turn-On Time: (Delay Time + Rise Time) For $V_D = V_{DROV}$ and $I_{GT} = 80$ mA, 0.1 μ s rise time, and $r_T = 10$ A (peak) At $T_C = +25^\circ\text{C}$	t_{GT}	-	2.2	-	2.2	-	2.2	-	2.2	-	2.2	-	-	μ s
Thermal Resistance: Junction-to-Case (Steady-State)	θ_{J-C}	-	-	4	-	-	4	-	-	4	-	-	-	$^\circ\text{C/W}$
Junction-to-Case (Transient)	θ_{J-C}	-	-	-	-	-	-	-	-	-	-	-	-	$^\circ\text{C/W}$
Junction-to-Ambient	θ_{J-A}	-	-	-	-	-	-	-	-	-	-	-	-	$^\circ\text{C/W}$

*For either polarity of main terminal 2 voltage (V_{MT2}) with reference to main terminal 1.

†For either polarity of gate voltage (V_{GT}) with reference to main terminal 1.

‡Variants of these devices having dv/dt characteristics selected specifically for inductive loads are available on special order; for additional information, contact your RCA Representative or your RCA Distributor.

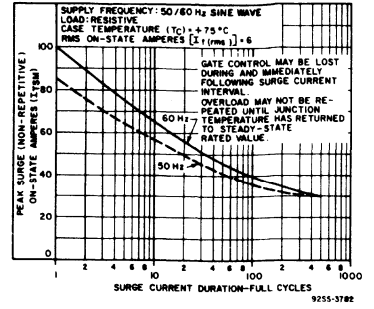


Fig. 4—Peak surge on-state current vs. surge-current duration.

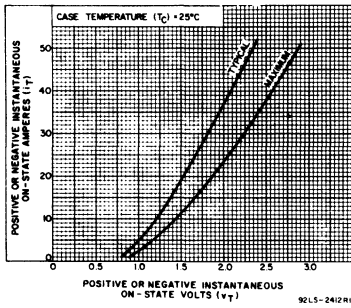


Fig. 5—On-state current vs. on-state voltage.

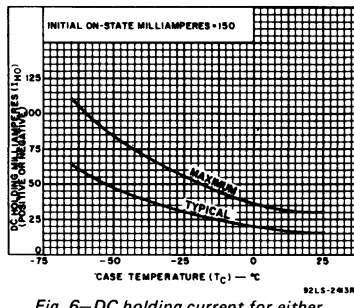


Fig. 6—DC holding current for either direction of on-state current vs. case temperature.

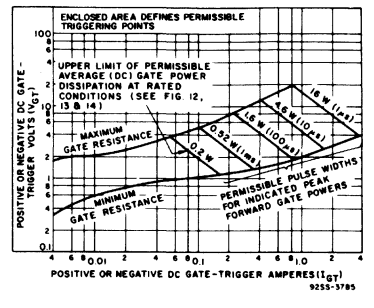


Fig. 7—Gate-pulse characteristics for all triggering modes.

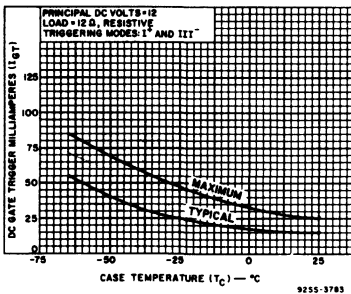


Fig. 8—DC gate-trigger current (for I^+ and III^+ triggering modes) vs. case temperature.

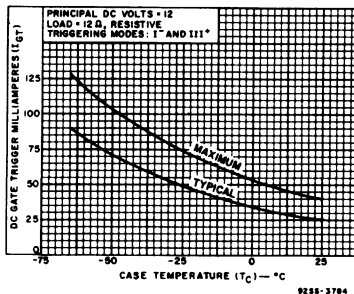


Fig. 9—DC gate-trigger current (for I^- and III^- triggering modes) vs. case temperature.

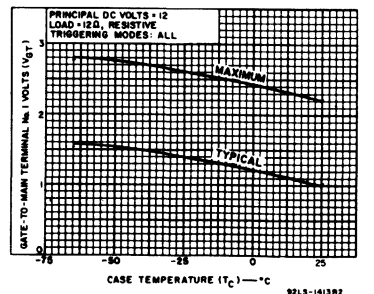


Fig. 10—DC gate-trigger voltage vs. case temperature.

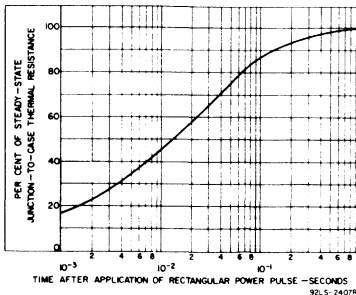


Fig. 11—Transient thermal resistance (junction-to-case vs. time).

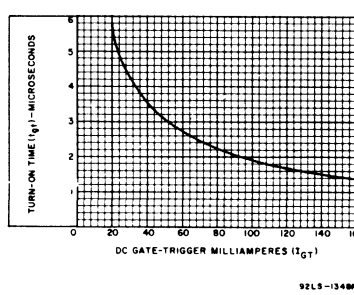


Fig. 12—Typical turn-on time vs. gate-trigger current.

T2800, T2801, T2802, T2850 Series

6-A and 8-A Silicon Triacs

Three-Lead Plastic Types for Power-Control and Power-Switching Applications

These RCA triacs are gate-controlled full-wave silicon switches utilizing a plastic case with three leads to facilitate mounting on printed-circuit boards. They are intended for the control of ac loads in such applications as motor controls, light dimmers, heating controls, and power-switching systems.

These devices are designed to switch from an off-state to an on-state for either polarity of applied voltage with positive or negative gate triggering voltages.

The T2801 and T2802 series triacs are characterized for I^+ , III^- gate triggering modes only and should suit a wide range of applications that employ diac or anode on/off triggering.

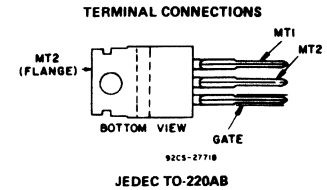
All series employ the plastic JEDEC TO-220AB package. The T2850-series package has three leads that are electrically isolated from the mounting flange. Because of this internal isolation, the triac can be mounted directly on a heat sink, without any insulating hardware; therefore heat transfer is improved and heat-sink size can be reduced.

Features:

- 80-A and 100-A Peak Surge Full-Cycle Current Ratings
- Glass Passivated Junctions
- Short-Emitter Center-Gate Design
- Low Switching Losses
- Low Thermal Resistance
- Package Design Facilitates Mounting on a Printed-Circuit Board

Additional Features for T2850 Series:

- Internal Isolation
- Package Suitable for Direct Mounting on Heat Sink



MAXIMUM RATINGS, Absolute-Maximum Values:

For Operation with Sinusoidal-Supply Voltage at Frequencies up to 50/60 Hz and with Resistive or Inductive Load.

	T2800F	T2800A	T2800B	T2800C	T2800D	T2800E	T2800M	—	
	T2801F	T2801A	T2801A	T2801B	T2801C	T2801D	T2801E	—	
	T2802F	T2802A	T2802B	T2802C	T2802D	T2802E	T2802M	T2802S	
	T2850F	T2850A	T2850B	—	T2850D	T2850E	—	—	
REPETITIVE PEAK OFF-STATE VOLTAGE: [●]									
Gate open, $T_J = -65$ to 100°C V_{DROM}	50	100	200	300	400	500	600	700	
RMS ON-STATE CURRENT (Conduction angle = 360°): $I_T(RMS)$									
Case Temperature									
$T_C = 80^\circ\text{C}$ (T2800, T2802, T2850 series)					8				A
$T_C = 80^\circ\text{C}$ (T2801 series only)					6				A
For other conditions					See Fig. 3				
PEAK SURGE (NON-REPETITIVE) ON-STATE CURRENT: [■] I_{TSM}									
For one cycle of applied principal voltage									
60 Hz (sinusoidal), $T_C = 80^\circ\text{C}$					100				A
(T2800, T2802, T2850 series)									
50 Hz (sinusoidal), $T_C = 80^\circ\text{C}$					85				A
(T2800, T2802, T2850 series)									
60 Hz (sinusoidal), $T_C = 80^\circ\text{C}$ (T2801 series only)					80				A
50 Hz (sinusoidal), $T_C = 80^\circ\text{C}$ (T2801 series only)					65				A
For more than one cycle of applied principal voltage					See Fig. 4, 5				
RATE OF CHANGE OF ON-STATE CURRENT:									
$V_D = V_{DROM}$; $I_{GT} = 200$ mA, $t_r = 0.1$ μs di/dt					70				A/ μs
FUSING CURRENT (for triac protection):									
At T_C shown for $I_T(RMS)$:									
$t = 20$ ms									
T2800, T2802, T2850					55				A ² s
T2801					35				A ² s
$t = 2.5$ ms									
T2800, T2802, T2850					28				A ² s
T2801					18				A ² s
$t = 0.5$ ms									
T2800, T2802, T2850					16				A ² s
T2801					10				A ² s
PEAK GATE-TRIGGER CURRENT: [■]									
For 1 μs max. See Fig. 11 I_{GTM}					4				A
GATE POWER DISSIPATION:									
Peak (for 1 μs max., $I_{GTM} \leq 4$ A, See Fig. 11) P_{GM}					16				W
AVERAGE (T2800, T2802, T2802 series) $P_{G(AV)}$					0.35				W
AVERAGE (T2850 series) $P_{G(AV)}$					0.2				W
TEMPERATURE RANGE: [▲]									
Storage T_{stg}					-65 to 150				$^\circ\text{C}$
Operating (Case) T_C					-65 to 100				$^\circ\text{C}$
TERMINAL TEMPERATURE (During soldering):									
For 10 s max. (terminals and case) T_T					225				$^\circ\text{C}$

[●]For either polarity of main terminal 2 voltage (V_{MT2}) with reference to main terminal 1.

[■]For either polarity of gate voltage (V_G) with reference to main terminal 1.

[▲]For temperature measurement reference point, see Dimensional Outline.

T2800, T2801, T2802, T2850 Series

ELECTRICAL CHARACTERISTICS, At Maximum Ratings Unless Otherwise Specified, and at Indicated Temperature

CHARACTERISTICS	SYMBOL	LIMITS For All Types Except as Specified			UNITS
		MIN.	TYP.	MAX.	
		Peak Off-State Current: [•] Gate open, $T_J = 100^\circ\text{C}$, $V_{DROM} = \text{Max. rated value}$	I_{DROM}	-	
Maximum On-State Voltage: [•] (See Fig. 6, 7) For $I_T = 30\text{ A (peak)}$, $T_C = 25^\circ\text{C}$ (T2800, T2802, T2850 series)	V_{TM}	-	1.7	2	V
For $I_T = 30\text{ A (peak)}$, $T_C = 25^\circ\text{C}$ (T2801 series)		-	2	3	
DC Holding Current: [•] Gate open, Initial principal current = 150 mA (dc) $v_D = 12\text{ V}$, $T_C = 25^\circ\text{C}$, T2800, T2850 series	I_{HO}	-	15	30	mA
T2801 series		-	100	-	
T2802 series		-	20	60	
For other case temperatures		See Fig. 8, 9, 10			
Critical Rate-of-Rise of Commutation Voltage: ^{••} For $v_D = V_{DROM}$, $I_T(\text{RMS}) = 8\text{ A}$, commutating $di/dt = 4.3\text{ A/ms}$, gate unenergized, $T_C = 80^\circ\text{C}$ (T2800, T2802, T2850 series)	dv/dt	4	10	-	V/ μs
For $v_D = V_{DROM}$, $I_T(\text{RMS}) = 6\text{ A}$, commutating $di/dt = 4.3\text{ A/ms}$, gate unenergized, $T_C = 80^\circ\text{C}$ (T2801 series)		2	10	-	
Critical Rate-of-Rise of Off-State Voltage: [•] For $v_D = V_{DROM}$, exponential voltage rise, gate open, $T_C = 100^\circ\text{C}$:	dv/dt				V/ μs
T2850A		125	350	-	
T2800B, T2802B, T2850B		100	300	-	
T2800C, T2802C		85	275	-	
T2800D, T2802D, T2850D		75	250	-	
T2800E, T2802E		65	225	-	
T2800M, T2802M		60	200	-	
T2801B		50	300	-	
T2801C		40	275	-	
T2801D		30	250	-	
T2801E	20	225	-		
DC Gate-Trigger Current: ^{•••} For $v_D = 12\text{ V (dc)}$, $R_L = 125\ \Omega$, $T_C = 25^\circ\text{C}$	I_{GT}				mA
Mode V_{MT2} V_G					
I^+ positive positive T2800, T2850 series		-	10	25	
T2801 series		-	25	80	
T2802 series		-	25	50	
T2800, T2802D, T2850D		-	15	25	
T2801 series	-	25	80		
T2802 series	-	25	50		
I^- positive negative T2800, T2850 series only		-	20	60	
I^{II+} negative positive T2800, T2850 series only		-	30	60	
For other case temperatures		See Fig. 12, 13, 14			
DC Gate-Trigger Voltage: ^{••} For $v_D = 12\text{ V (dc)}$, $R_L = 125\ \Omega$, $T_C = 25^\circ\text{C}$	V_{GT}	-	1.25	2.5	V
T2800, T2802, T2850 series		-	1.5	4	
T2801 series		See Fig. 15, 16			
For other case temperatures		0.2	-	-	
Gate-Controlled Turn-On Time: (Delay Time + Rise Time) For $v_D = V_{DROM}$, $I_{GT} = 80\text{ mA}$, $t_r = 0.1\ \mu\text{s}$, $i_T = 10\text{ A (peak)}$, $T_C = 25^\circ\text{C}$ (T2800, T2802, T2850 series)	t_{gt}	-	1.6	2.5	μs
(T2801 series)		-	2.2	-	
Thermal Resistance:					$^\circ\text{C/W}$
Junction-to-Case (T2800, T2801, T2802 series)	$R_{\theta JC}$	-	-	2.1	
(T2850 series)		-	-	3.1	
Junction-to-Ambient	$R_{\theta JA}$	-	-	60	

- For either polarity of main terminal 2 voltage (V_{MT2}) with reference to main terminal 1.
- For either polarity of gate voltage (V_G) with reference to main terminal 1.
- Variants of these devices having dv/dt characteristics selected specifically for inductive loads are available on special order; for additional information, contact your RCA Representative or your RCA Distributor.

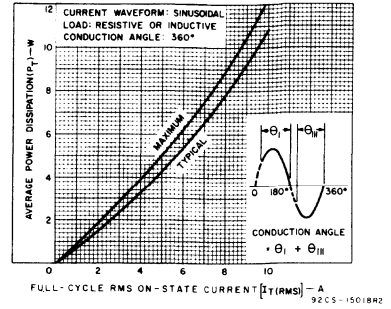


Fig. 1 — Power dissipation vs. on-state current for T2800, T2802, T2850 series.

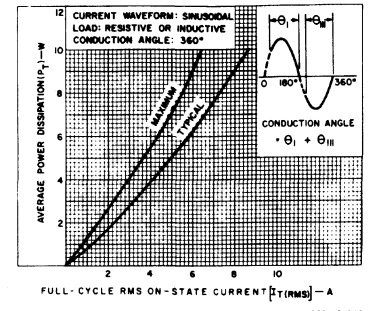


Fig. 2 — Power dissipation vs. on-state current for T2801 series.

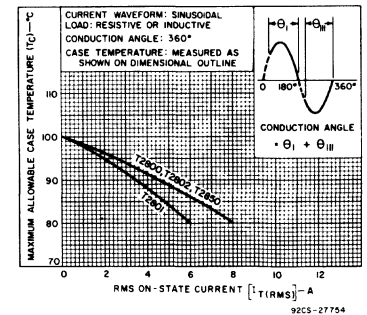


Fig. 3 — Maximum allowable case temperature vs. on-state current.

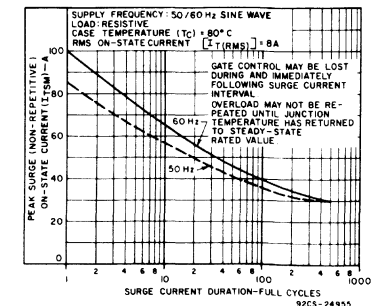


Fig. 4 — Peak surge on-state current vs. surge current duration for T2800, T2802, T2850 series.

T2800, T2801, T2802, T2850 Series

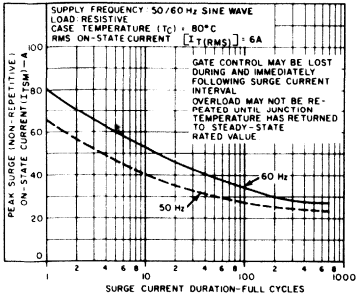


Fig. 5 - Peak surge on-state current vs. surge current duration for T2801 series.

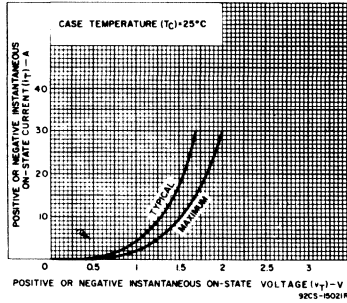


Fig. 6 - On-state current vs. on-state voltage for T2800, T2802, T2850 series.

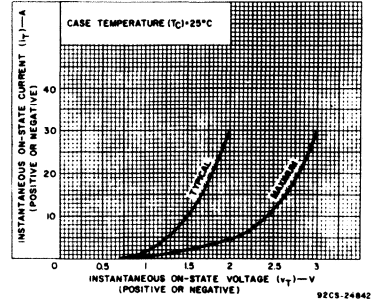


Fig. 7 - On-state current vs. on-state voltage for T2801 series.

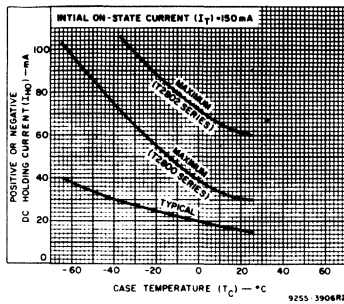


Fig. 8 - DC holding current vs. case temperature for T2800, T2802.

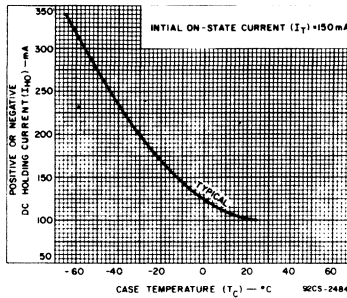


Fig. 9 - DC holding current vs. case temperature for T2801 series.

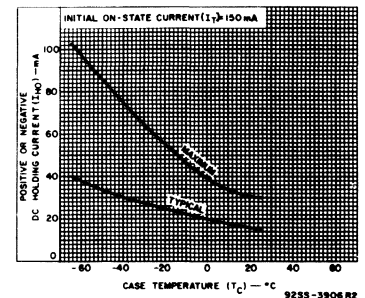


Fig. 10 - DC holding current vs. case temperature for T2850 series.

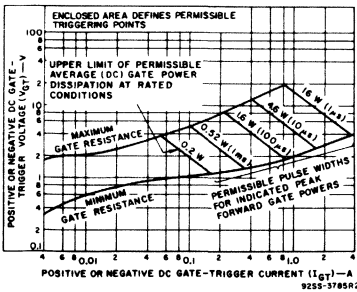


Fig. 11 - Gate pulse characteristics for all triggering modes for all series.

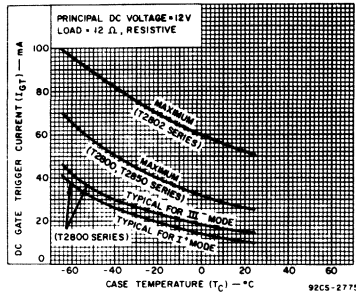


Fig. 12 - DC gate-trigger current (for I_{T1} and III^{-} triggering modes) vs. case temperature for T2800, T2802, T2850 series.

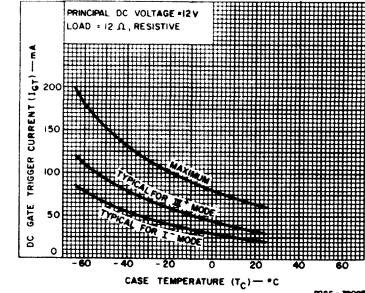


Fig. 13 - DC gate-trigger current (for I_{T1} and III^{+} triggering modes) vs. case temperature for T2800, T2802, T2850 series.

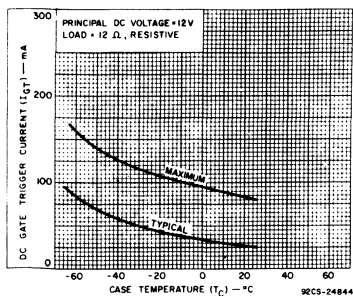


Fig. 14 - DC gate-trigger current (for I_{T1} and III^{-} triggering modes) vs. case temperature for T2801 series.

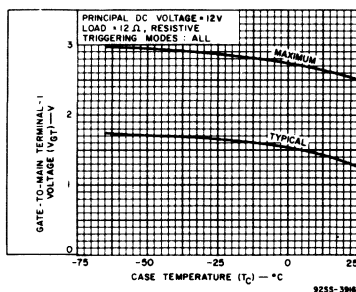


Fig. 15 - DC gate-trigger voltage vs. case temperature for T2800, T2802, T2850 series.

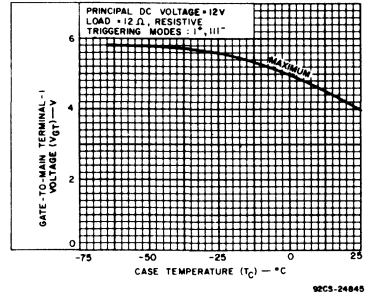


Fig. 16 - DC gate-trigger voltage vs. case temperature for T2801 series.

T2800, T2801, T2802, T2850 Series

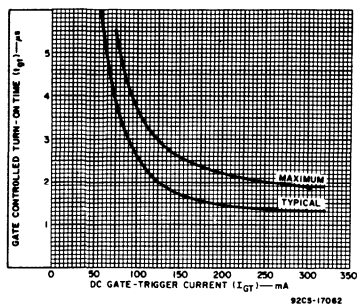


Fig. 17 - Turn-on time vs. gate-trigger current for T2800, T2802, T2850 series.

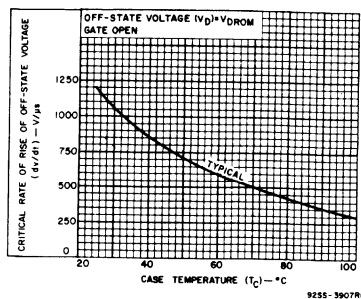


Fig. 18 - Typical critical rate-of-rise of off-state voltage vs. case temperature for all series.

T2851 Series

8-A Isolated-Tab Silicon Triacs

Three-Lead Plastic Types for Power-Control and Power-Switching Applications

The RCA-T2851 series triacs are gate-controlled full-wave silicon switches utilizing a plastic case with three leads to facilitate mounting on printed-circuit boards. They are intended for the control of ac loads in such applications as motor controls, light dimmers, heating controls, and power-switching systems.

These devices are designed to switch from an off-state to an on-state for either polarity of applied voltage with positive or negative gate-triggering voltages. They have an on-state current rating of 8 amperes at a T_C of 75°C and repetitive off-state voltage ratings of 200, 300, 400, and 500 volts.

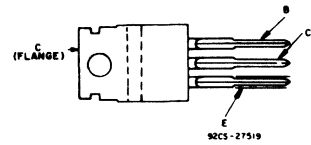
These triacs are characterized for I⁺, III⁻ gate-triggering modes only and should suit a wide range of applications that employ diac or anode on/off triggering.

The T2851 series types employ an ISOWATT package, a plastic case with three leads that are electrically isolated from the mounting flange. Because of this internal isolation, the triac can be mounted directly on a heat sink, without any insulating hardware; therefore heat transfer is improved and heat-sink size can be reduced.

Features:

- Internal isolation
- 100-A peak surge full-cycle current ratings
- Shorted-emitter, center-gate design
- Low switching losses
- Low thermal resistance
- Package suitable for direct mounting on heat sink
- Glass-passivated junctions

TERMINAL CONNECTIONS



JEDEC TO-220AB

MAXIMUM RATINGS, Absolute-Maximum Values:

For Operation with Sinusoidal Supply Voltage at Frequencies up to 50/60 Hz and with Resistive or Inductive Load.

	T2851B	T2851C	T2851D	T2851E	
V_{DROM}^* $T_J = -85$ to 100°C	200	300	400	500	V
$I_T(\text{RMS})$ $T_C = 75^\circ\text{C}, \theta = 360^\circ$	8				A
For other conditions	See Fig. 3				
I_{TSM}					
For one cycle of applied principal voltage					
60 Hz (sinusoidal), $T_C = 75^\circ\text{C}$	100				A
50 Hz (sinusoidal), $T_C = 75^\circ\text{C}$	85				A
For more than one cycle of applied principal voltage	See Fig. 4				
di/dt					
$V_D = V_{DROM} \cdot I_{GT} = 200 \text{ mA}, t_r = 0.1 \mu\text{s}$	70				A/ μs
I^2t (At T_C shown for $I_T(\text{RMS})$, half-sine wave):					
See Fig. 5					
$t = 20 \text{ ms}$	55				A ² s
$= 2.5 \text{ ms}$	28				A ² s
$= 0.5 \text{ ms}$	16				A ² s
I_{GTM}^*					
For 1 μs max., See Fig. 6	4				A
P_{GM} (For 1 μs max., $I_{GTM} \leq 4 \text{ A}$), See Fig. 6	16				W
$P_G(\text{AV})$	0.2				W
T_{stg}	-65 to 150				$^\circ\text{C}$
T_C	-65 to 100				$^\circ\text{C}$
T_T (During soldering for 10 s max.)	225				$^\circ\text{C}$

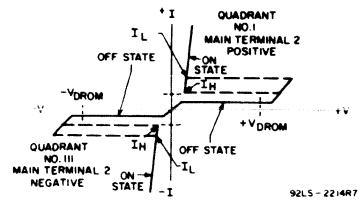


Fig. 1 — Principal voltage-current characteristic.

* For either polarity of main terminal 2 voltage (V_{MT2}) with reference to main terminal 1.
 * For either polarity of gate voltage (V_G) with reference to main terminal 1.

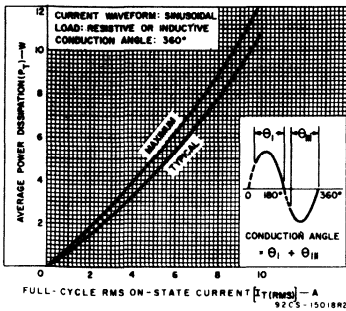


Fig. 2 — Power dissipation as a function of on-state current.

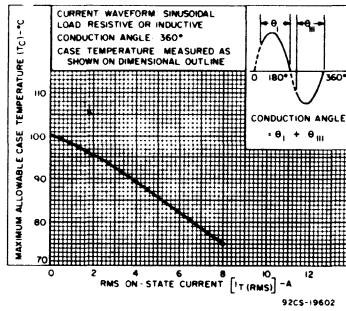


Fig. 3 — Allowable case temperature as a function of on-state current.

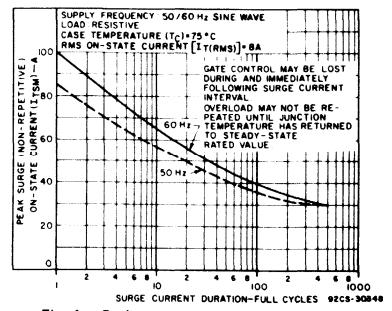


Fig. 4 — Peak surge on-state current as a function of surge current duration.

T2851 Series

ELECTRICAL CHARACTERISTICS

At Maximum Ratings Unless Otherwise Specified, and at Indicated Temperatures

CHARACTERISTIC	LIMITS For All Types Except as Specified			UNITS
	Min.	Typ.	Max.	
I_{DROM}^{\bullet} $T_J = 100^{\circ}C, V_{DROM} = \text{Max. rated value}$	—	0.1	2	mA
V_{TM}^{\bullet} $i_T = 30 \text{ A (peak)}, T_C = 25^{\circ}C, \text{ See Fig. 7}$	—	1.7	2	V
I_{HO}^{\bullet} $v_D = 12 \text{ V}, T_C = 25^{\circ}C$ For other case temperatures	—	100	—	mA
dv/dt (Commutating) $^{\bullet}$ $v_D = V_{DROM}, I_T(RMS) = 6 \text{ A}, di/dt = 4.3 \text{ A/ms},$ gate unenergized, $T_C = 75^{\circ}C, \text{ See Fig. 12}$	2	10	—	V/ μ s
dv/dt (Off-State) $^{\bullet}$ $v_D = V_{DROM}, \text{ exponential voltage rise, gate open,}$ $T_C = 100^{\circ}C$				
	T2851B	50	300	—
	T2851C	40	275	—
	T2851D	30	250	—
	T2851E	20	225	—
I_{GT}^{\bullet} Mode V_{MT2} V_G $v_D = 12 \text{ V dc}$ I ⁺ + + $R_L = 12 \Omega$ $T_C = 25^{\circ}C$ III ⁻ - - For other case temperatures	—	25	80	mA
$V_{GT}^{\bullet\bullet}$ $v_D = 12 \text{ V dc}, R_L = 12 \Omega, T_C = 25^{\circ}C$ $v_D = V_{DROM}, R_L = 125 \Omega, T_C = 100^{\circ}C$ For other case temperatures	—	1.5	3	V
		0.2	—	—
t_{gt} $v_D = V_{DROM}, I_{GT} = 80 \text{ mA}, t_r = 0.1 \mu\text{s}, i_T = 10 \text{ A (peak)},$ $T_C = 25^{\circ}C, \text{ See Fig. 13}$	—	2.2	—	μ s
$R_{\theta JC}$	—	—	3.1	$^{\circ}C/W$
$R_{\theta JA}$	—	—	60	$^{\circ}C/W$

- For either polarity of main terminal 2 voltage (V_{MT2}) with reference to main terminal 1.
- For either polarity of gate voltage (V_G) with reference to main terminal 1.

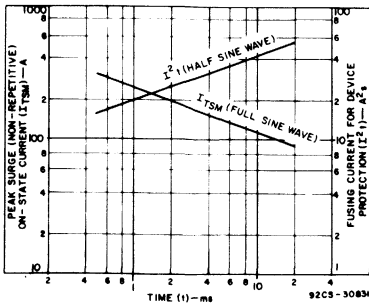


Fig. 5 - Peak surge on-state current and fusing current as a function of time.

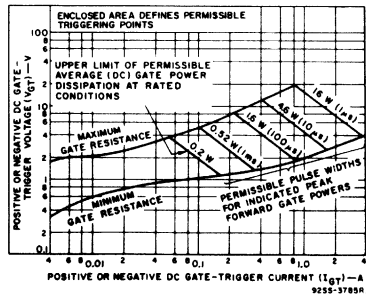


Fig. 6 - Gate-pulse characteristics for all triggering modes.

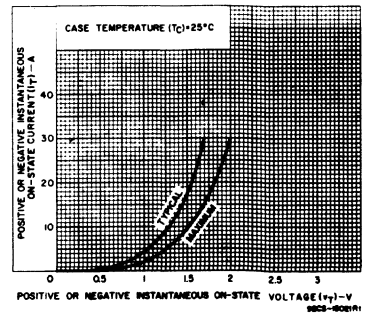


Fig. 7 - On state current as a function of on-state voltage.

T2851 Series

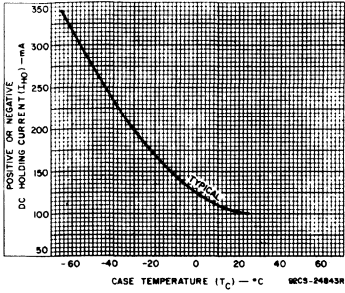


Fig. 8 - DC holding current as a function of case temperature.

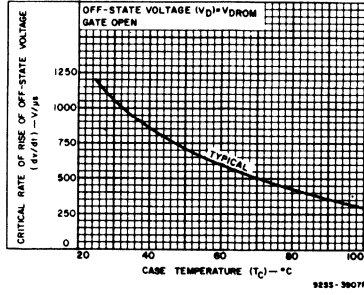


Fig. 9 - Typical critical rate-of-rise of off-state voltage as a function of case temperature for T2851B.

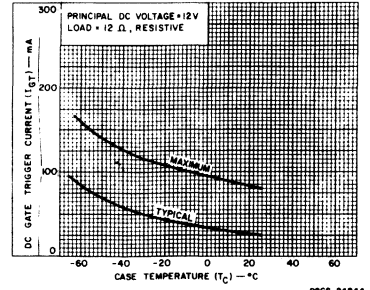


Fig. 10 - DC gate-trigger current (for I⁺ and III⁻ triggering modes) as a function of case temperature.

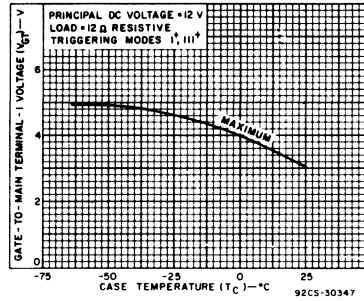


Fig. 11 - DC gate-trigger voltage as a function of case temperature.

T4100, T4101, T4110, T4111, T4120, T4121 Series

(Includes 2N5567-2N5574)

10-A and 15-A Silicon Triacs

For General Purpose AC Power Switching

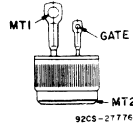
These RCA triacs are gate-controlled, full-wave silicon ac switches. They are designed to switch from an off-state to an on-state for either polarity of applied voltage with positive or negative gate triggering voltages.

These triacs are intended for control of ac loads in applications such as heating controls, motor controls, arc-welding equipment, light dimmers, and power switching systems.

Features:

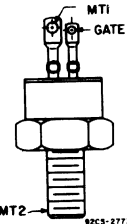
- di/dt Capability = 150 A/μs
- Shorted-Emitter, Center-Gate Design
- Low Switching Losses
- Low On-State Voltage at High Current Levels
- Low Thermal Resistance

TERMINAL CONNECTIONS



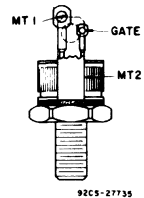
- 2N5667 T4100F T4101E
 2N5568 T4100E T4101F
 2N5571 T4100M T4101M
 2N5572

Press-Fit Types



- 2N5569 T4110E
 2N5570 T4110M
 2N5573 T4111F
 2N5574 T4111E
 T4110F T4111M

Stud Types



- T4120B T4121B
 T4120D T4121D
 T4120E T4121E
 T4120F T4121F
 T4120M T4121M

Isolated-Stud Types

MAXIMUM RATINGS, Absolute-Maximum Values:

For Operation with Sinusoidal Supply Voltage at Frequencies up to 50/60 Hz and with Resistive or Inductive Load.

***REPETITIVE PEAK OFF STATE VOLTAGE:**

Gate open, $T_J = -65$ to 100°C

***RMS ON-STATE CURRENT (Conduction angle = 360°):**

Case temperature

$T_C = 65^\circ\text{C}$ (2N5567, 68, 69, 70, T4101M, T4111M, T4121B, D, M)

= 80°C (2N5571, 72, 73, 74, T4100M, T4110M)

Press-fit & stud types)

= 75°C (T4120B, D, M - Isolated stud types)

For other conditions

PEAK SURGE (NON-REPETITIVE) ON-STATE CURRENT

For one cycle of applied principal voltage, T_C as above

60 Hz (sinusoidal)

50 Hz (sinusoidal)

For more than one cycle of applied principal voltage

RATE-OF-CHANGE-OF-ON-STATE CURRENT

$V_{DM} = V_{DROM}$; $I_{GT} = 160$ mA, $t_r = 0.1$ μs

FUSING CURRENT (for Triac Protection):

At T_C shown for $I_T(\text{RMS})$

$t = 20$ ms

= 2.5 ms

= 0.5 ms

PEAK GATE-TRIGGER CURRENT

For 1 μs max., See Fig. 11

***GATE POWER DISSIPATION:**

PEAK (For 1 μs max., $I_{GTM} \leq 4$ A, See Fig. 11)

AVERAGE

***TEMPERATURE RANGE**

Storage

Operating (Case)

***TERMINAL TEMPERATURE (During soldering)**

For 10 s max. (terminals and case)

STUD TORQUE:

Recommended

Maximum (DO NOT EXCEED)

	T4100F	2N5567	2N5568	T4100E	T4100M
V_{DORM}	50	200	400	500	600
$I_T(\text{RMS})$					
		10			A
		15			A
		15			A
		See Fig. 3, 4			
I_{TSM}					
		100			A
		85			A
		See Fig. 5, 6			
di/dt			150		A/μs
I^2t					
		55			A ² s
		28			A ² s
		16			A ² s
I_{GTM}			4		A
P_{GM}			16		W
$P_{G(AV)}$			0.5		W
T_{stg}			-65 to 150		$^\circ\text{C}$
T_C			-65 to 100		$^\circ\text{C}$
T_T			225		$^\circ\text{C}$
T_s			35		in-lb
			50		in-lb

* In accordance with JEDEC registration data format (JES-14, R0F 2) filed for the JEDEC (2N-Series) types.
 * For either polarity of main terminal 2 voltage (V_{MT2}) with reference to main terminal 1.
 * For either polarity of gate voltage (V_G) with reference to main terminal 1.
 * For temperature measurement reference point, see Dimensional Outline.

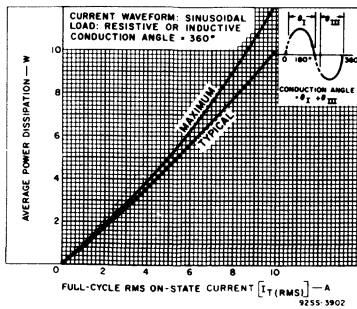


Fig. 1 - Power dissipation vs. on-state current for all 10-A triacs.

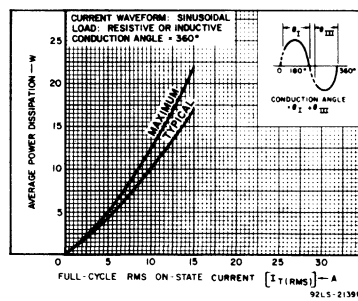


Fig. 2 - Power dissipation vs. on-state current for all 15-A triacs.

T4100, T4101, T4110, T4111, T4120, T4121 Series (Includes 2N5567-2N5574)

ELECTRICAL CHARACTERISTICS, At Maximum Ratings and at Indicated Case Temperature (T_C) Unless Otherwise Indicated

CHARACTERISTICS	SYMBOL	LIMITS			UNITS
		MIN.	TYP.	MAX.	
Peak Off-State Current: [Ⓐ] Gate open, $T_J = 100^\circ\text{C}$, $V_{DROM} = \text{Max. rated value}$	I_{DROM}	—	0.1	2*	mA
Maximum On-State Voltage: [Ⓐ] For $I_T = 14\text{ A (peak)}$, $T_C = 25^\circ\text{C}$ (2N5567, 68, 69, 70, T4101M, T4111M, T4121 series) = 21 A (peak), $T_C = 25^\circ\text{C}$ (2N5571, 72, 73, 74, T4100M, T4110M, T4120 series)	V_{TM}	—	1.35	1.65*	mA
DC Holding Current: [Ⓐ] Gate open, Initial principal current = 500 mA (DC), $v_D = 12\text{ V}$: 2N5567, 68, 69, 70, T4101M, T4111M, T4121 series: $T_C = 25^\circ\text{C}$ $T_C = -65^\circ\text{C}$ 2N5571, 72, 73, 74, T4100M, T4110M, T4120 series: $T_C = 25^\circ\text{C}$ $T_C = -65^\circ\text{C}$ For other case temperature	I_{HO}	—	15	30 75	V
Critical Rate-of-Rise of Commutation Voltage: [Ⓐ] For $v_D = V_{DROM}$, $I_T(\text{RMS}) = 10\text{ A}$, commutating $di/dt = 5.4\text{ A/ms}$, gate unenergized, $T_C = 85^\circ\text{C}$ 2N5567, 68, 69, 70, T4101M, T4111M, T4121 series For $v_D = V_{DROM}$, $I_T(\text{RMS}) = 15\text{ A}$, commutating $di/dt = 8\text{ A/ms}$, gate unenergized, $T_C = 80^\circ\text{C}$ (2N5571, 72, 73, 74, T4100M, T4110M — Press-fit & stud types) = 75°C (T4120B, D, M — Isolated stud)	dv/dt	2*	5	—	V/ μs
Critical Rate-of-Rise of Off-State Voltage: [Ⓐ] For $v_D = V_{DROM}$, exponential voltage rise, gate open, $T_C = 100^\circ\text{C}$: 2N5567, 2N5568, T4121, 2N5571, 2N5573, T4120B 2N5568, 2N5670, T4121D, 2N5572, 2N5574, T4120D T4101M, T4111M, T4121M, T4100M, T4110M, T4120M	dv/dt	30*	150	—	V/ μs
DC Gate-Trigger Current: ^{ⒶⒷ} For $v_D = 12\text{ V (DC)}$, $R_L = 30\ \Omega$, $T_C = 25^\circ\text{C}$ Mode V_{MT2} V_G I^+ positive positive All 10-A triacs All 15-A triacs I^{II-} negative negative All 10-A triacs All 15-A triacs I^- positive negative All 10-A triacs All 15-A triacs I^{III+} negative positive All 10-A triacs All 15-A triacs For other case temperatures	I_{GT}	—	10 20 — 20 35 — 20 35	25 50 — 40 80 — 40 80	mA
DC Gate-Trigger Voltage: ^{ⒶⒷ} For $v_D = 12\text{ V (DC)}$, $R_L = 30\ \Omega$ $T_C = 25^\circ\text{C}$ $T_C = -65^\circ\text{C}$ For other case temperatures For $v_D = V_{DROM}$, $R_L = 125\ \Omega$, $T_C = 100^\circ\text{C}$	V_{GT}	—	1 2	2.5 4*	V
Gate-Controlled Turn-On Time: (Delay Time + Rise Time) For $v_D = V_{DROM}$, $I_{GT} = 180\text{ mA}$, $t_r = 0.1\ \mu\text{s}$, $I_T = 15\text{ A (peak)}$ All 10-A triacs, $I_T = 25\text{ A (peak)}$ All 15-A triacs, $T_C = 25^\circ\text{C}$	t_{gt}	—	1.6	2.5	μs
Thermal Resistance: Junction-to-Case: Steady-State Transient Junction-to-Isolated Hex (Stud, see Dim. Outline): Steady-State	θ_{JC} θ_{J-H}	—	—	1* — 1.1	$^\circ\text{C/W}$

* In accordance with JEDEC registration data format (IS-14, RDF 2) filed for the JEDEC (2N-Series) types.
[Ⓐ] For either polarity of main terminal 2 voltage (V_{MT2}) with reference to main terminal 1.
[Ⓑ] For either polarity of gate voltage (V_G) with reference to main terminal 1.

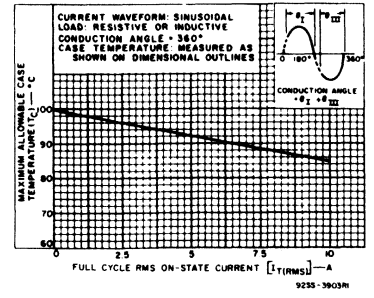


Fig. 3 — Maximum allowable case temperature vs. on-state current for all 10-A triacs.

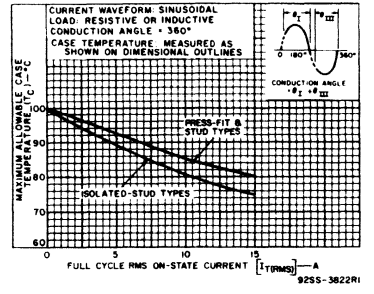


Fig. 4 — Maximum allowable case temperature vs. on-state current for all 15-A triacs.

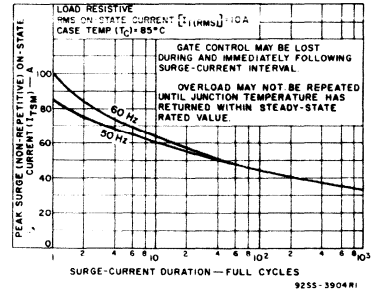


Fig. 5 — Peak surge on-state current vs. surge current duration for all 10-A triacs.

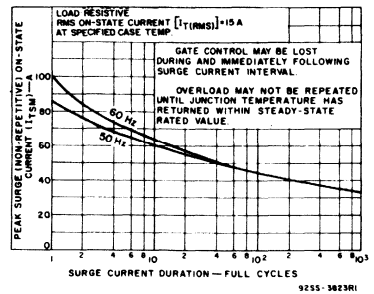


Fig. 6 — Peak surge on-state current vs. surge current duration for all 15-A triacs.

T4100, T4101, T4111, T4120, T4121 Series (Includes 2N5567-2N5574)

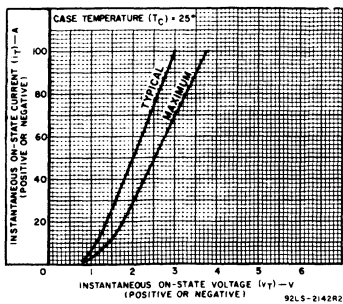


Fig. 7 — On-state current vs. on-state voltage for all 10-A triacs.

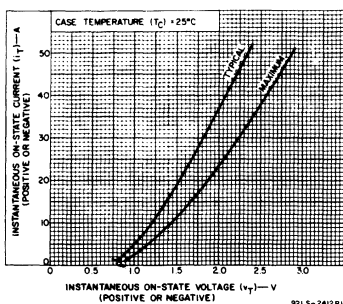


Fig. 8 — On-state current vs. on-state voltage for all 15-A triacs.

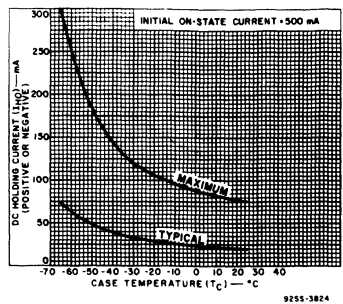


Fig. 9 — DC holding current vs. case temperature for all 10-A triacs.

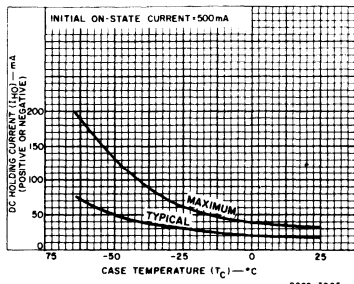


Fig. 10 — DC holding current vs. case temperature for all 15-A triacs.

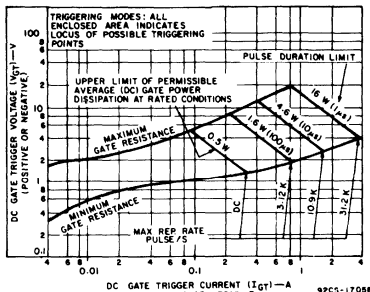


Fig. 11 — Gate trigger characteristics and limiting conditions for determination of permissible gate trigger pulses for all triacs.

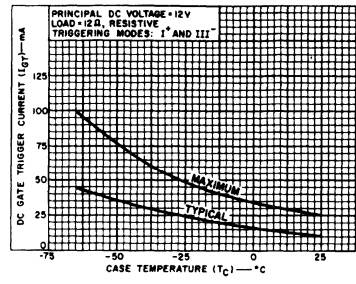


Fig. 12 — DC gate-trigger current vs. case temperature (I⁺ and III⁺ modes) for all 10-A triacs.

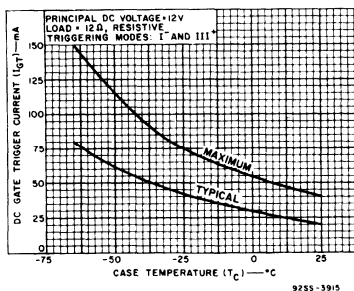


Fig. 13 — DC gate-trigger current vs. case temperature (I⁺ & III⁺ modes) for all 10-A triacs.

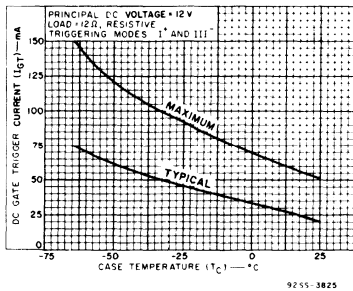


Fig. 14 — DC gate-trigger current vs. case temperature (I⁺ & III⁺ modes) for all 15-A triacs.

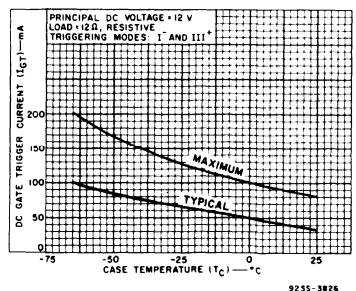


Fig. 15 — DC gate-trigger current vs. case temperature (I⁺ & III⁺ modes) for all 15-A triacs.

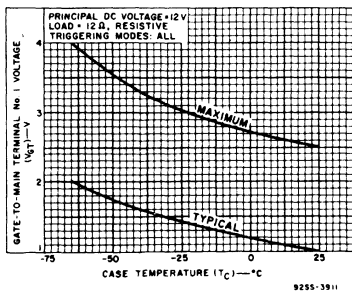


Fig. 16 — DC gate-trigger voltage vs. case temperature for all 10-A triacs.

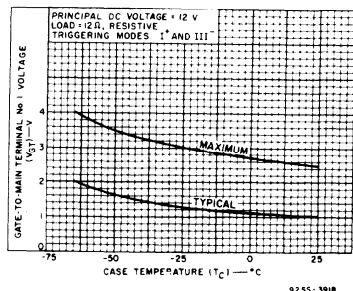


Fig. 17 — DC gate-trigger voltage vs. case temperature for all 15-A triacs.

T4100, T4101, T4110, T4120, T4121 Series (Includes 2N5567-2N5574)

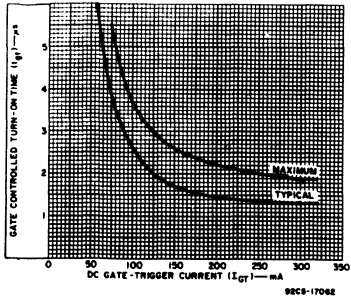


Fig. 18 - Turn-on time vs. gate trigger current for all types.

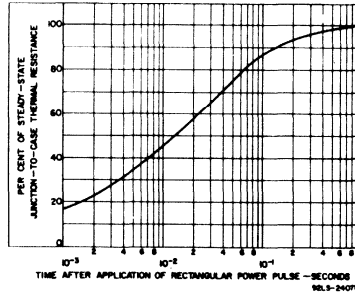


Fig. 19 - Transient junction-to-case thermal resistance vs. time for all triacs.

WARNING:
The RCA isolated-stud package thyristors should be handled with care. The ceramic portion of these thyristors contains BERYLLIUM OXIDE as a major ingredient. Do not crush, grind, or abrade these portions of the thyristors because the dust resulting from such action may be hazardous if inhaled.

T4103-T4105, T4113-T4115 Series 400-Hz, 6, 10, & 15-A Silicon Triacs

For Control-Systems Application in Airborne and Ground-Support Type Equipment

These RCA triacs are gate-controlled full-wave silicon ac switches.

The devices are designed to switch from an off-state to an on-state for either polarity of applied voltage with positive or negative gate triggering voltages.

They are intended for operation up to 400 Hz with resistive or inductive loads and nominal line voltages of 115 and 208

V RMS sine wave and repetitive peak off-state voltages of 200 V and 400 V.

These triacs exhibit commutating voltage (dv/dt) capability at high commutating current (di/dt). They can also be used in 60-Hz applications where high commutating capability is required.

MAXIMUM RATINGS, Absolute-Maximum Values
For Operation with Sinusoidal Supply Voltage at Frequencies up to 400 Hz and with Resistive or Inductive Load

REPETITIVE PEAK OFF-STATE VOLTAGE:*
Gate open, $I_T = 50$ to 100°C

RMS ON-STATE CURRENT (Conduction angle = 360°):
Case temperature

- $I_T = 90^{\circ}\text{C}$ (T4105B, T4105D, T4115B, T4115D)
- $= 85^{\circ}\text{C}$ (T4104B, T4104D, T4114B, T4114D)
- $= 80^{\circ}\text{C}$ (T4103B, T4103D, T4113B, T4113D)

For other conditions

PEAK SURGE (NON-REPETITIVE) ON-STATE CURRENT
For one cycle of applied principal voltage

- 400 Hz (sinusoidal)
- 60 Hz (sinusoidal)
- 50 Hz (sinusoidal)

For more than one cycle of applied principal voltage

RATE-OF-CHANGE OF ON-STATE CURRENT:
 $V_{DM} = V_{DROM}$, $I_{GT} = 160$ mA, $t_r = 0.1$ μ s

FUSING CURRENT (for triac protection):
 $I_T = 50$ to 100°C , $t = 1.25$ to 10 ms

PEAK GATE-TRIGGER CURRENT:*
For 1 μ s max.

GATE POWER DISSIPATION:
PEAK (for 1 μ s max., $I_{GTM} \leq 4$ A, See Fig. 6)

AVERAGE

TEMPERATURE RANGE:

Storage

Operating (Case)

TERMINAL TEMPERATURE (During soldering):
For 10 s max. (terminals and case)

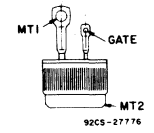
STUD TORQUE: τ_s

Recommended

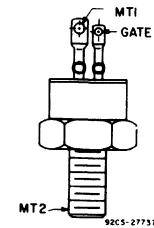
Maximum (DO NOT EXCEED)

Part No.	V _{DROM}	I _{T(RMS)}	I _{TSM}	di/dt	i ² t	I _{GTM}	P _{GM}	P _{G(AV)}	T _{stg}	T _C	T _T	Stud Torque
T4103B	200	6	200	150	30	4	16	0.2	50	50	225	35
T4113B	400	10	100	150	30	4	16	0.2	50	50	225	35
T4103D	200	6	200	150	30	4	16	0.2	50	50	225	35
T4113D	400	10	100	150	30	4	16	0.2	50	50	225	35
T4103E	200	6	200	150	30	4	16	0.2	50	50	225	35
T4113E	400	10	100	150	30	4	16	0.2	50	50	225	35
T4103M	200	6	200	150	30	4	16	0.2	50	50	225	35
T4113M	400	10	100	150	30	4	16	0.2	50	50	225	35
T4104B	200	15	100	150	30	4	16	0.2	50	50	225	35
T4114B	400	15	100	150	30	4	16	0.2	50	50	225	35
T4104D	200	15	100	150	30	4	16	0.2	50	50	225	35
T4114D	400	15	100	150	30	4	16	0.2	50	50	225	35
T4104E	200	15	100	150	30	4	16	0.2	50	50	225	35
T4114E	400	15	100	150	30	4	16	0.2	50	50	225	35
T4104M	200	15	100	150	30	4	16	0.2	50	50	225	35
T4114M	400	15	100	150	30	4	16	0.2	50	50	225	35
T4105B	200	15	100	150	30	4	16	0.2	50	50	225	35
T4115B	400	15	100	150	30	4	16	0.2	50	50	225	35
T4105D	200	15	100	150	30	4	16	0.2	50	50	225	35
T4115D	400	15	100	150	30	4	16	0.2	50	50	225	35
T4105E	200	15	100	150	30	4	16	0.2	50	50	225	35
T4115E	400	15	100	150	30	4	16	0.2	50	50	225	35
T4105M	200	15	100	150	30	4	16	0.2	50	50	225	35
T4115M	400	15	100	150	30	4	16	0.2	50	50	225	35

TERMINAL CONNECTIONS



T4103 Series
T4104 Series
T4105 Series



T4113 Series
T4114 Series
T4115 Series

Stud

- * For either polarity of main terminal 2 voltage (V_{M2}) with reference to main terminal 1
- * For either polarity of gate voltage (V_G) with reference to main terminal 1
- * For temperature measurement reference point, see Dimensional Outline

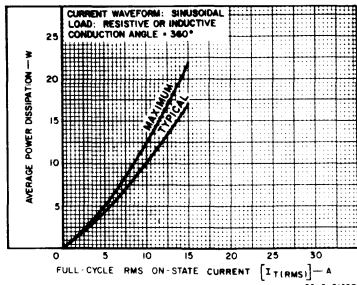


Fig. 1—Power dissipation vs. on-state current.

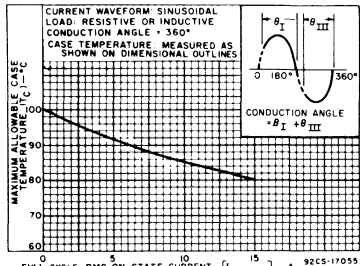


Fig. 2—Maximum allowable case temperature vs. on-state current*

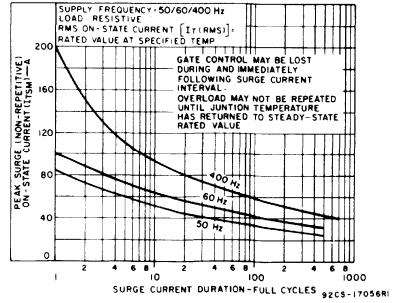


Fig. 3—Peak surge on-state current vs. surge current duration.

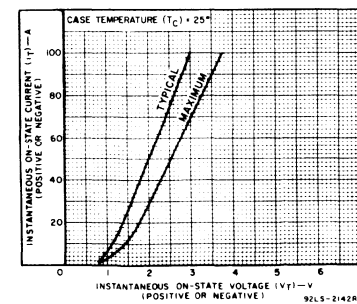


Fig. 4—On-state current vs. on-state voltage.

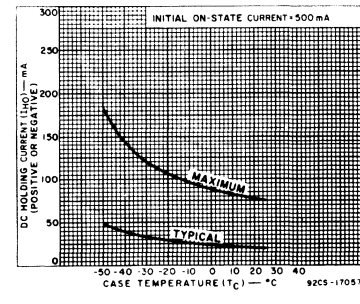


Fig. 5—DC holding current vs. case temperature.

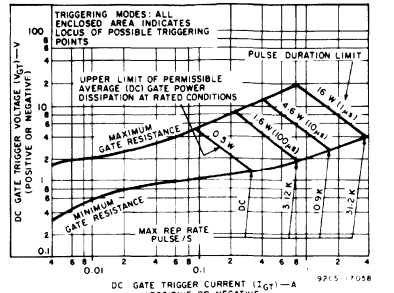


Fig. 6—Gate-trigger characteristics and limiting conditions for determination of permissible gate-trigger pulses.

T4103-T4105, T4113-T4115 Series

ELECTRICAL CHARACTERISTICS

At Maximum Ratings and at Indicated Case Temperature (T_C) Unless Otherwise Specified

CHARACTERISTIC	SYMBOL	LIMITS			UNITS
		ALL TYPES			
		Min	Typ	Max	
Peak Off-State Current \blacklozenge Gate open, $T_J = 100^\circ\text{C}$, $V_{DROM} = \text{Max. rated value}$	I_{DROM}		0.1	2	mA
Maximum On-State Voltage \blacklozenge For $I_T = 21\text{ A (peak)}$, $T_C = 25^\circ\text{C}$	V_{TM}		1.4	1.8	V
DC Holding Current \blacklozenge Gate open, Initial principal current = 500 mA (DC), $v_D = 12\text{ V}$, $T_C = 25^\circ\text{C}$ For other case temperatures	I_{HO}		20	75	mA
Critical Rate-of-Rise of Commutation Voltage \blacklozenge For $v_D = V_{DROM}$, I_T (RMS) = rated value, gate unenergized Commutating di/dt = 21.4 A/ms, $T_C = 90^\circ\text{C}$ T4105B, T4105D, T4115B, T4115D Commutating di/dt = 36 A/ms, $T_C = 85^\circ\text{C}$ T4104B, T4104D, T4114B, T4114D Commutating di/dt = 53.3 A/ms, $T_C = 80^\circ\text{C}$ T4103B, T4103D, T4113B, T4113D	di/dt		5	10	V μs
Critical Rate-of-Rise of Off-State Voltage \blacklozenge For $v_D = V_{DROM}$, exponential voltage rise, gate open, $T_C = 100^\circ\text{C}$	dv/dt		30	150	V μs
DC Gate-Trigger Current \blacklozenge [†] For $v_D = 12\text{ V (DC)}$, $R_L = 30\ \Omega$ and $T_C = 25^\circ\text{C}$	Mode	V_{MT2}	V_G		
	I ⁺	positive	positive	20	50
	III ⁻	negative	negative	20	50
	I ⁻	positive	negative	35	80
	III ⁺	negative	positive	35	80
For other case temperatures				See Figs. 7 & 8	
DC Gate-Trigger Voltage \blacklozenge [†] For $v_D = 12\text{ V (DC)}$, $R_L = 30\ \Omega$, $T_C = 25^\circ\text{C}$ For other case temperatures For $v_D = V_{DROM}$, $R_L = 125\ \Omega$, $T_C = 100^\circ\text{C}$	V_{GT}			1	2.5
				See Fig. 9	
Gate-Controlled Turn-On Time (Delay Time + Rise Time) For $v_D = V_{DROM}$, $I_{GT} = 160\text{ mA}$, $t_r = 0.1\ \mu\text{s}$, $i_T = 25\text{ A (peak)}$, $T_C = 25^\circ\text{C}$	t_{gt}			1.6	2.5
				μs	
Thermal Resistance					
Steady-State (Junction-to-Case)	θ_{JC}			1	$^\circ\text{C/W}$
Transient (Junction-to-Case)				See Fig. 11	
Steady-State (Junction-to-Ambient)	θ_{JA}			33	$^\circ\text{C/W}$

\blacklozenge For either polarity of main terminal 2 voltage (V_{MT2}) with reference to main terminal 1.

[†] For either polarity of gate voltage (V_G) with reference to main terminal 1.

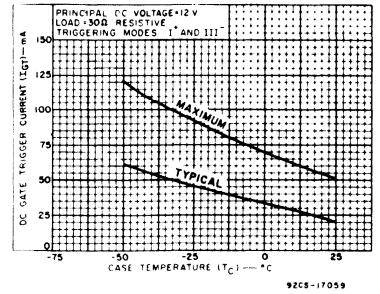


Fig. 7—DC gate-trigger current vs. case temperature. (I⁺ and III⁻ modes).

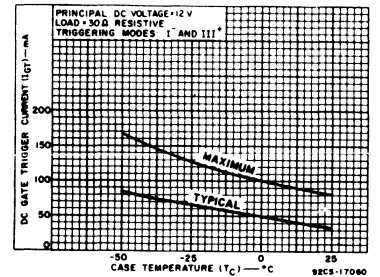


Fig. 8—DC gate-trigger current vs. case temperature. (I⁻ and III⁺ modes).

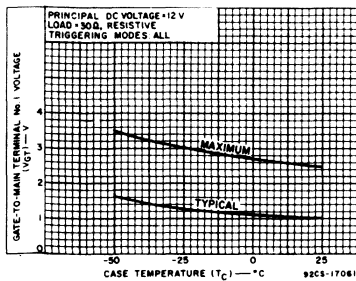


Fig. 9—DC gate-trigger voltage vs. case temperature.

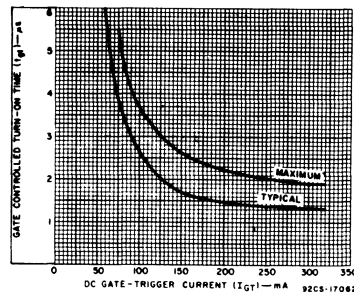


Fig. 10—Turn-on time vs. gate-trigger current.

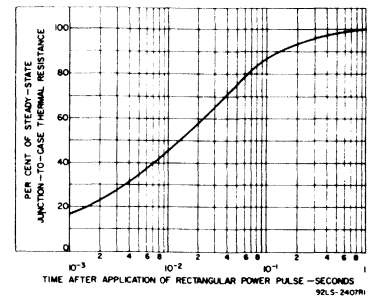


Fig. 11—Transient thermal resistance vs. time (junction-to-case).

T4130, T4131, T4140, T4141, T4150, T4151, T6430, T6431, T6440, T6441, T6450, T6451 Series

10-, 15-, 30-, and 40-A Silicon Triacs

For Phase-Control and Load-Switching Applications

These RCA triacs are gate-controlled, full wave ac switches. They are designed to switch from an off-state to an on state for either polarity of applied voltage with positive or negative gate triggering voltages.

The T4130, T4140, and T4150 series have current ratings of 15 amperes. The T4131, T4141, and T4151 series have current ratings of 10 amperes. The T6430, T6440, and T6450 series have current ratings of 40

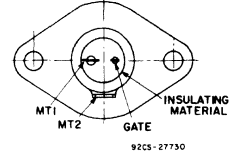
amperes. The T6431, T6441, and T6451 series have current ratings of 30 amperes. Triacs in each series have voltage ratings of 50 to 600 volts.

The T4130, T4131, T6430, and T6431 series employ a press-fit package with flexible leads, encapsulated on an isolated stud.

Features:

- 3-kV rms encapsulant (HYPOT) breakdown voltage
- Flame-resistant encapsulant (self-extinguishing)
- Rugged packages
- Standard RCA triac features

TERMINAL CONNECTIONS



Press-Fit, Isolated on TO-3 Flange

T4140 T6440
T4141 T6441

FLEXIBLE-LEAD (TERMINAL) CONNECTIONS

Flexible-Lead (Insulation) Color Terminal
 Yellow — Gate
 Red — Main Terminal No. 1
 Black — Main Terminal No. 2

Note: Terminals are identified by color code only. Position of the flexible leads (relative to terminals of the device) leaving the encapsulant is random.

Press-Fit, Encapsulated on Isolated-Stud with Flexible Leads

T4130 T6430
T4131 T6431

Press-Fit, Encapsulated, Isolated on TO-3 Flange with Flexible Leads

T4150 T6450
T4151 T6451

WARNING: The ceramic used in these packages contains beryllium oxide. Do not crush, grind, or abrade these portions because the dust resulting from such action may be hazardous if inhaled. Disposal should be by burial.

The T4140, T4141, T6440, and T6441 series employ a press-fit package, isolated on a TO-3 flange. The T4150, T4151, T6450, and T6451 series employ a press-fit package with flexible leads encapsulated on an isolated TO-3 flange.

Type No.	Rep. Peak Off-State Voltage V _{DRM} (V)	On-State Current		Package (Press-fit)	Wire Size		Wire Insulation Thickness		Refer to Bulletin File No.*
		I _T (RMS) (A)	T _C (°C)		MT 1&2 Gage No.	Gate Gage No.	MT 1&2 in. (mm)	Gate in. (mm)	

10-A Triacs — T4131, T4141, and T4151 Series Electrical and Mechanical Data

T4131F	50	10	85	With flex.leads, encap.on isolated-stud	14	22	0.031 (0.787)	0.016 (0.406)	457
T43131B	200								
T4131D	400								
T4131E	500								
T4131M	600								
T4141F	50	10	85	Isolated on TO-3 flange	—	—	—	—	457
T4141B	200								
T4141D	400								
T4141E	500								
T4141M	600								
T4151F	50			With flex.leads, encap.,isolated on TO-3 flange	14	22	0.031 (0.787)	0.016 (0.406)	457
T4151B	200								
T4151D	400								
T4151E	500								
T4151M	600								

15-A Triacs — T4130, T4140, and T4150 Series Electrical and Mechanical Data

T4130F	50	15	75	With flex.leads, encap.on isolated-stud	14	22	0.031 (0.787)	0.016 (0.406)	458
T4130B	200								
T4130D	400								
T4130E	500								
T4130M	600								
T4140F	50			Isolated on TO-3 flange	—	—	—	—	458
T4140B	200								
T4140D	400								
T4140E	500								
T4140M	600								
T4150F	50	15	75	With flex.leads, encap.,isolated on TO-3 flange	14	22	0.031 (0.787)	0.016 (0.406)	458
T4150B	200								
T4150D	400								
T4150E	500								
T4150M	600								

30-A Triacs — T6431, T6441, and T6451 Series Electrical and Mechanical Data

T6431F	50	30	55	With flex.leads, encap.on isolated-stud	12	22	0.034 (0.863)	0.016 (0.406)	459
T6431B	200								
T6341D	400								
T6431E	500								
T6431M	600								
T6441F	50	30	55	Isolated on TO-3 flange	—	—	—	—	459
T6441B	200								
T6441D	400								
T6441E	500								
T6441M	600								

T4130, T4131, T4140, T4150, T4151, T6430, T6431, T6440, T6441, T6450, T6451 Series

Type No.	Rep. Peak Off-State Voltage V_{DROM} (V)	On-State Current		Package (Press-fit)	Wire Size		Wire Insulation Thickness		Refer to Bulletin File No.*
		I_T (RMS) (A)	T_C (°C)		MT 1&2 Gage No.	Gate Gage No.	MT 1&2 in. (mm)	Gate in. (mm)	
30-A Triacs – T6431, T6441, and T6451 Series Electrical and Mechanical Data (cont'd)									
T6451F	50	30	55	With flex.leads, encap.,isolated on TO-3 flange	12	22	0.034 (0.863)	0.016 (0.406)	459
T6451B	200								
T6451D	400								
T6451E	500								
T6451M	600								
40-A Triacs – T6430, T6440, and T6450 Series Electrical and Mechanical Data									
T6430F	50	40	60	With flex.leads, encap. on isolated-stud	12	22	0.034 (0.863)	0.016 (0.406)	593
T6430B	200								
T6430	400								
T6430E	500								
T6430M	600								
T6440F	50	40	60	Isolated on TO-3 flange	-	-	-	-	593
T6440B	200								
T6440D	400								
T6440E	500								
T6440M	600								
T6450F	50	40	60	With flex.leads, encap.,isolated on TO-3 flange	12	22	0.034 (0.863)	0.016 (0.406)	593
T6450B	200								
T6450D	400								
T6450E	500								
T6450M	600								

* Electrical characteristics and ratings given in these bulletins also apply to the types listed in this chart.

T4700 Series

15-A Silicon Triacs

For Low-Power Phase Control and Load-Switching Applications

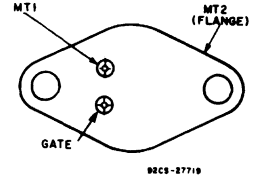
RCA T4700 series are gate-controlled full-wave ac silicon switches. They are designed to switch from an off-state to a conducting state for either polarity of applied voltage with positive or negative gate triggering.

These devices are intended for the control of ac loads in applications such as space heater, oven and furnace controls, motor controls, and lamp loads.

Features:

- di/dt Capability = 150 A/ μ s
- Shorted-Emitter, Center-Gate Design
- Low Switching Losses
- Low On-State Voltage at High Current Levels
- Low Thermal Resistance

TERMINAL CONNECTIONS



BOTTOM VIEW

JEDEC TO-66

MAXIMUM RATINGS, Absolute-Maximum Values:

For Operation with 50/60-Hz, Sinusoidal Supply Voltage and Resistive or Inductive Load

	T4700F	T4700B	T4700D	T4700E	
REPEITITIVE PEAK OFF-STATE VOLTAGE [■]					
Gate Open	V _{DROM}	50	200	400	500
RMS ON-STATE CURRENT:					
T _C = 70°C, conduction angle = 360°	I _{T(RMS)}	15			
PEAK SURGE (NON-REPETITIVE) ON-STATE CURRENT:	I _{TSM}	100			
For one full cycle of applied principal voltage		85			
60 Hz (sinusoidal), T _C = 70°C		See Fig. 3			
For one full cycle of applied principal voltage					
(50-Hz, sinusoidal), T _C = 70°C					
For more than one full cycle of applied voltage					
PEAK GATE-TRIGGER CURRENT:	I _{GTM}	4			
For 1 μ s max.					
RATE OF CHANGE OF ON-STATE CURRENT:	di/dt	150			
V _D = V _{DROM} , I _{GT} = 200 mA, t _r = 0.1 μ s					
FUSING CURRENT (for triac protection):	I ² t	50			
T _J = -40 to 100°C, t = 1.25 to 10 ms					
GATE POWER DISSIPATION:	P _{GM}	16			
Peak [▲] (for 1 μ s max. and I _{GTM} = 4 A)		0.45			
Average (averaging time = 10 ms max.)	P _{G(AV)}				
TEMPERATURE RANGE: [▲]	T _{stg}	-40 to 150			
Storage		-40 to 100			
Operating (Case)	T _C				
PIN TEMPERATURE (During soldering):	T _p	225			
At distances \geq 1/32 in. (0.8 mm) from seating plane for 10 s max.					

- For either polarity of main terminal 2 voltage (V_{MT2}) with reference to main terminal 1.
- ▲ For either polarity of gate voltage (V_G) with reference to main terminal 1.
- ▲ For temperature measurement reference point, see Dimensional Outline.

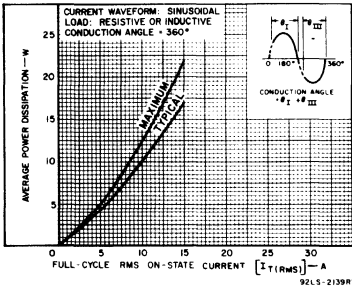


Fig. 1—Power dissipation curve.

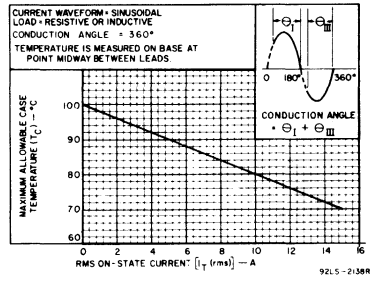


Fig. 2—Conduction rating chart (case temperature).

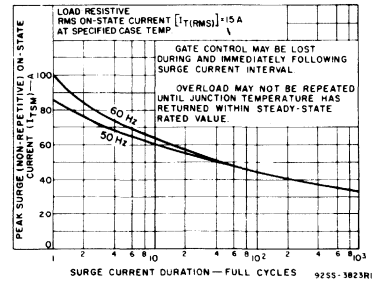


Fig. 3—Surge current rating chart.

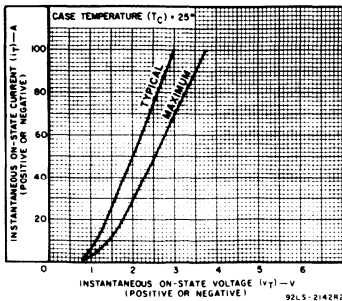


Fig. 4—On-state characteristics for either direction of principal current.

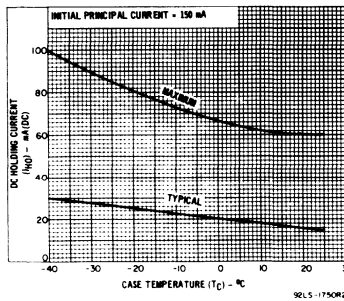


Fig. 5—DC holding current characteristics for either direction of principal current.

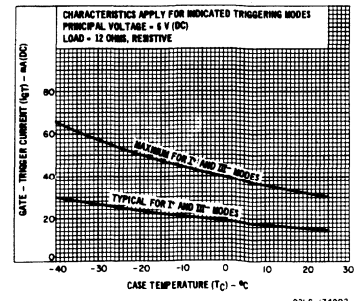


Fig. 6—DC gate-trigger current characteristics for I⁺ and I^{III-} modes.

T4700 Series

ELECTRICAL CHARACTERISTICS

At Maximum Ratings Unless Otherwise Specified and at Indicated Case Temperature (T_C)

CHARACTERISTICS	TRIAC TYPES						UNITS
	T4700B			T4700D			
	Min.	Typ.	Max.	Min.	Typ.	Max.	
Peak Off-State Current[Ⓐ], I_{DROM}							
Gate open							
At $T_j = +100^\circ\text{C}$ and $V_{DROM} = \text{Max. rated value}$	—	0.2	4	—	0.2	4	mA
Instantaneous On-State Voltage[Ⓐ], v_T							
For $i_T = 30\text{ A (peak)}$ and $T_C = +25^\circ\text{C}$	—	1.6	2.0	—	1.6	2.0	V(peak)
DC Holding Current[Ⓐ], I_{HO}							
Gate Open							
Initial principal current = 150 mA (dc)							
At $T_C = +25^\circ\text{C}$	—	15	60	—	15	60	mA(dc)
For other case temperatures	See Fig. 5			See Fig. 5			
Critical Rate of Rise of Off-State Voltage[Ⓐ], Commutating dv/dt:							
For $v_D = V_{DROM}$, $i_T(\text{RMS}) = 15\text{ A}$, commutating $di/dt = 8\text{ A/ms}$, and gate unenergized							
At $T_C = +70^\circ\text{C}$	2	10	—	2	10	—	V/ μs
Critical Rate of Rise of Off-State Voltage[Ⓐ], Critical dv/dt:							
For $v_D = V_{DROM}$, exponential voltage rise, gate open							
At $T_C = +100^\circ\text{C}$	30	150	—	20	100	—	V/ μs
DC Gate-Trigger Current^{Ⓐ, Ⓜ}, I_{GT}							
For $v_D = 6\text{ volts (dc)}$, $R_L = 12\text{ ohms}$, $T_C = +25^\circ\text{C}$, and Specified Triggering Mode:							
I ⁺ Mode: V_{T2} is positive, V_G is positive	—	15	30	—	15	30	mA(dc)
I ⁻ Mode: V_{T2} is positive, V_G is negative	—	35	80	—	35	80	mA(dc)
III ⁺ Mode: V_{T2} is negative, V_G is positive	—	35	80	—	35	80	mA(dc)
III ⁻ Mode: V_{T2} is negative, V_G is negative	—	15	30	—	15	30	mA(dc)
For other case temperatures	See Figs. 6 & 7			See Figs. 6 & 7			
DC Gate-Trigger Voltage^{Ⓐ, Ⓜ}, V_{GT}:							
For $v_D = 6\text{ volts (dc)}$ and $R_L = 12\text{ ohms}$							
At $T_C = +25^\circ\text{C}$	—	1	2.5	—	1	2.5	V(dc)
For other case temperatures	See Fig. 8			See Fig. 8			
For $v_D = V_{DROM}$ and $R_L = 125\text{ ohms}$							
At $T_C = +100^\circ\text{C}$	0.2	—	—	0.2	—	—	V(dc)
Gate-Controlled Turn-On Time, t_{gt} (Delay Time + Rise Time)							
For $v_D = V_{DROM}$, $I_{GT} = 160\text{ mA}$, $0.1\text{ }\mu\text{s}$ rise time, and $i_T = 25\text{ A (peak)}$							
At $T_C = +25^\circ\text{C}$	—	1.6	2.5	—	1.6	2.5	μs
Thermal Resistance, Junction to case, $R_{\theta JC}$	—	—	1.3	—	—	1.3	$^\circ\text{C/W}$

[Ⓐ]For either polarity of main terminal 2 voltage (V_{T2}) with reference to main terminal 1.
[Ⓜ]For either polarity of gate voltage (V_G) with reference to main terminal 1.

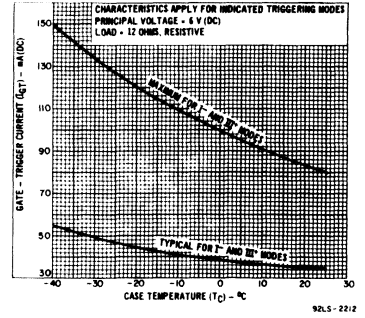


Fig. 7—DC gate-trigger current characteristics for I⁻ and III⁺ modes.

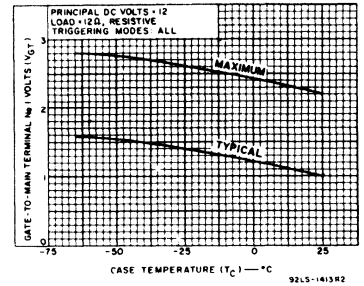


Fig. 8—DC gate-trigger voltage characteristics.

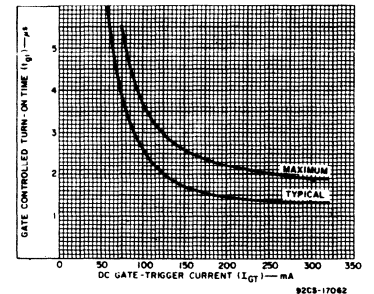


Fig. 9—Turn-on time vs. gate-trigger current.

T6000, T6001, T6006 Series 16-A Silicon Triacs

Three-Lead Plastic Types for Power-Control and Power-Switching Applications

The RCA-T6000, T6001 and T6006 series triacs are gate-controlled full-wave silicon switches utilizing a plastic case with three leads to facilitate mounting on printed-circuit boards. They are intended for the control of ac loads in such applications as motor controls, light dimmers, heating controls, and power-switching systems.

These devices are designed to switch from an off-state to an on-state for either polarity of applied voltage with positive or negative gate triggering voltages. They have an on-state current rating of 16 amperes at a T_C of 80°C and repetitive off-state voltage ratings of 50 to 600 volts.

The T6001-series triacs are characterized for I⁺, III⁻ gate triggering modes only and should suit a wide range of applications that employ diac or anode on/off triggering.

The T6006-series triacs are characterized for I⁺ and III⁺ gate-triggering modes only. They are intended for power-control applications in which integrated-circuit zero-crossing switches, such as the RCA-CA3059 series, are used as the triac-triggering circuits. The T6006-series triacs have gate characteristics which assure that a CA3059-series integrated circuit can supply sufficient gate current to trigger them over their full operating temperature range.

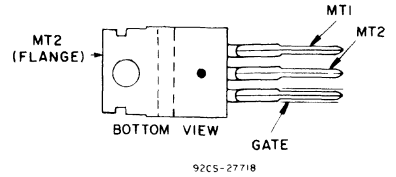
The plastic package design provides not only ease of mounting but also low thermal impedance, which allows operation at high case temperatures and permits reduced heat-sink size.

Lead-form options of the TO-220 package are available. See page on "Lead-Form for RCA Plastic Power Packages".

Features:

- 150-A peak surge full-cycle current ratings
- Shorted-emitter center-gate design
- Low switching losses
- Low thermal resistance
- Package design facilitates mounting on a printed-circuit board

TERMINAL DESIGNATIONS



JEDEC TO-220AB

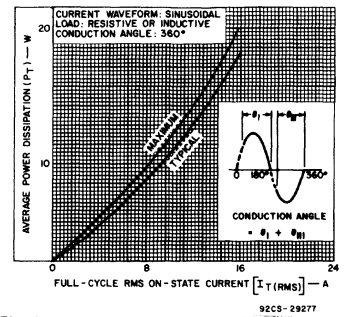


Fig. 1 - Power dissipation vs on-state current.

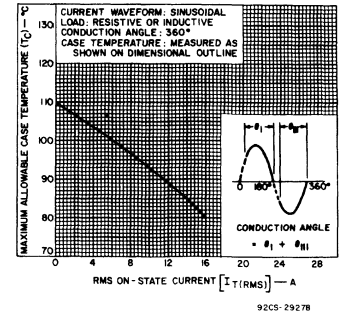


Fig. 2 - Maximum allowable case-temperature vs on-state current.

Maximum Ratings, Absolute-Maximum Values:

	T6000F T6001F	T6000B T6006B	T6000C T6006C	T6000D T6006D	T6000E T6006E	T6000M T6001M T6006M	
V_{DROM}^{\bullet} $T_J = -65$ to $110^{\circ}C$	50	200	300	400	500	600	V
$I_T(RMS)$ $T_C = 80^{\circ}C, \theta = 360^{\circ}$				16			A
For other conditions				See Fig. 2			
I_{TSM}							
For one cycle of applied principal voltage							
60 Hz (sinusoidal), $T_C = 80^{\circ}C$				150			A
50 Hz (sinusoidal), $T_C = 80^{\circ}C$				140			A
For more than one cycle of applied principal voltage				See Fig. 3			
di/dt							
$v_D = V_{DROM}, I_{GT} = 200$ mA, $t_r = 0.1$ μs				100			A/ μs
i^2t [At T_C shown for $I_T(RMS)$]:							
t = 10 ms				100			A ² s
t = 4.25 ms				49			A ² s
I_{GTM}^{\blacksquare}							
For 1 μs max.				4			A
P_{GM} (For 1 μs max., $I_{GTM} \leq 4$ A)				16			W
$P_G(AV)$				0.5			W
T_{stg}				-65 to 150			$^{\circ}C$
T_C				-65 to 110			$^{\circ}C$
T_T (During soldering for 10 s max.)				225			$^{\circ}C$

- For either polarity of main terminal 2 voltage (V_{MT2}) with reference to main terminal 1.
- For either polarity of gate voltage (V_G) with reference to main terminal 1.

T6000, T6001, T6006 Series

ELECTRICAL CHARACTERISTICS

At Maximum Ratings Unless Otherwise Specified, and at Indicated Temperatures

CHARACTERISTIC	LIMITS For All Types Except as Specified			UNITS	
	Min.	Typ.	Max.		
I_{DROM}^{\bullet} $T_J = 110^{\circ}C, V_{DROM} = \text{Max. rated value}$	—	0.1	1.2	mA	
V_{TM}^{\bullet} $i_T = 30 \text{ A (peak)}, T_C = 25^{\circ}C$	T6000, T6006 Series T6001 Series	— —	1.4 1.8	1.75 2.0	V
I_{HO}^{\bullet} $v_D = 12 \text{ V}, T_C = 25^{\circ}C$	T6000 Series T6001 Series	— —	15 20	35 50	mA
For other case temperatures	See Fig. 7				
$dv/dt^{\bullet\bullet}$ $v_D = V_{DROM}, I_T(RMS) = 16 \text{ A}, di/dt = 8.5 \text{ A/ms}, T_C = 80^{\circ}C$		4	10	—	V/ μ s
dv/dt^{\bullet} $v_D = V_{DROM}, T_C = 100^{\circ}C$					
T6000B, T6001B, T6006B	100	300	—		
T6000C, T6001C, T6006C	85	275	—		
T6000D, T6001D, T6006D	75	250	—		
T6000E, T6001E, T6006E	65	225	—		
T6000M, T6001M, T6006M	60	200	—		
$I_{GT}^{\bullet\bullet}$ Mode V_{MT2} V_G					
$v_D = 12 \text{ V (dc)}$ I^+ positive positive	T6000 series	—	25	50	mA
$R_L = 30 \Omega$	T6001 series	—	—	80	
$T_C = 25^{\circ}C$	T6006 series	—	—	45	
III^- negative negative	T6000 series	—	25	50	
	T6001 series	—	—	80	
I^- positive negative	T6000 series only	—	45	80	mA
III^+ negative positive	T6000 series only	—	45	80	
	T6006	—	—	45	
For other case temperatures.	See Figs. 9 and 10				
$V_{GT}^{\bullet\bullet}$					
$v_D = 12 \text{ V (dc)}, R_L = 30 \Omega, T_C = 25^{\circ}C$	T6001 I^+ III^-	—	1.25	3.0	V
	T6006 I^+ III^+	—	1.25	1.5	
	T6000 all modes	—	1.25	2.5	
$v_D = V_{DROM}, R_L = 125 \Omega, T_C = 100^{\circ}C$		0.2	—	—	
For other case temperatures.	See Fig. 11				
t_{gt} $v_D = V_{DROM}, I_{GT} = 80 \text{ mA}, t_r = 0.1 \mu\text{s}, i_T = 25 \text{ A (peak)}, T_C = 25^{\circ}C$		—	1.6	2.5	μ s
$R_{\theta JC}$		—	—	1.5	$^{\circ}C/W$
$R_{\theta JA}$		—	—	50	$^{\circ}C/W$

- For either polarity of main terminal 2 voltage (V_{MT2}) with reference to main terminal 1.
- For either polarity of gate voltage (V_G) with reference to main terminal 1.
- ▲ Variants of these devices having dv/dt characteristics selected specifically for inductive loads are available on special order; for additional information, contact your RCA Representative or your RCA Distributor.

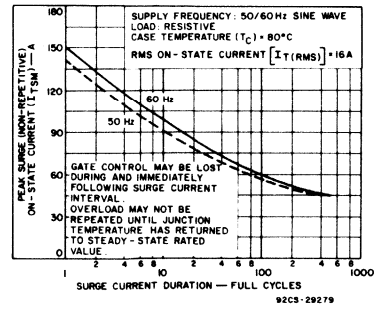


Fig. 3 - Peak surge on-state current vs surge current duration.

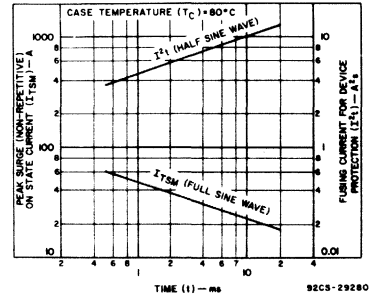


Fig. 4 - Peak surge on-state current and fusing-current vs time.

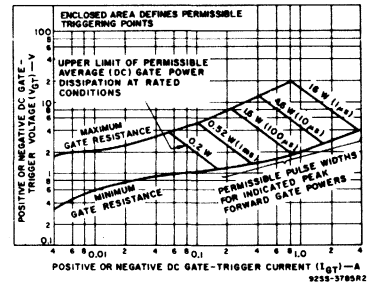


Fig. 5 - Gate pulse characteristics for all triggering modes.

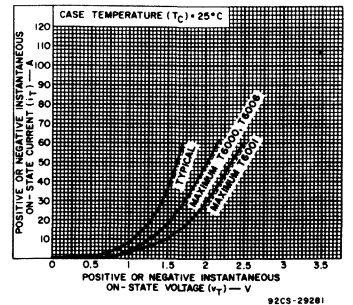


Fig. 6 - On-state current vs on-state voltage.

T6000, T6001, T6006 Series

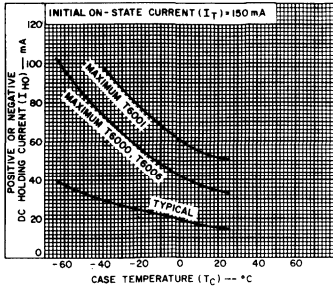


Fig. 7 — DC holding current vs case temperature.

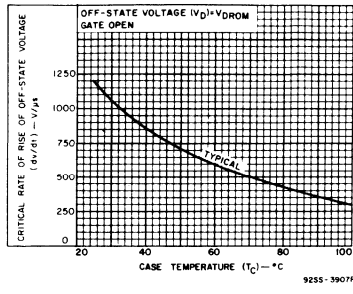


Fig. 8 — Typical critical rate-of-rise of off-state voltage vs case temperature.

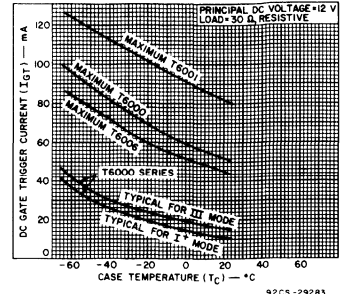


Fig. 9 — DC gate-trigger current (for I^+ and III^- triggering modes) vs case temperature.

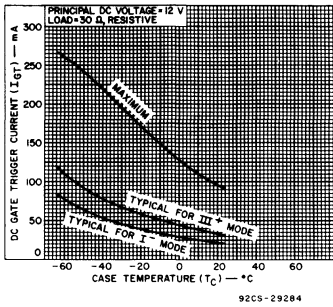


Fig. 10 — DC gate-trigger current (for I^- and III^+ triggering modes) vs case temperature for T6000-series only.

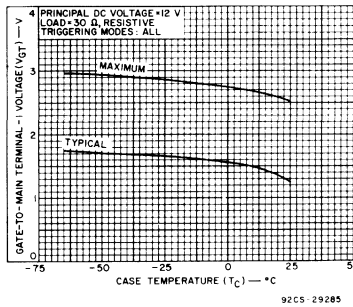


Fig. 11 — DC gate-trigger voltage vs case temperature for T6000 series only.

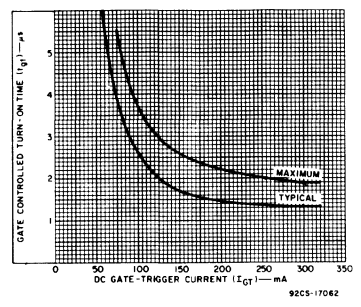


Fig. 12 — Turn-on time vs gate-trigger current.

2N6342A-2N6344A, 2N6346A-2N6348A, (T6000) Series

12-A Silicon Triacs

Three-Lead Plastic Types for Power-Control and Power-Switching Applications

The 2N6342A-44A, and 2N6346A-48A series triacs are gate-controlled full-wave silicon switches utilizing a plastic case with three leads to facilitate mounting on printed-circuit boards. They are intended for the control of ac loads in such applications as motor controls, light dimmers, heating controls, and power-switching systems.

These devices are designed to switch from an off-state to an on-state for either polarity

of applied voltage with positive or negative gate triggering voltages. They have an on-state current rating of 12 amperes at a T_C of 80°C and repetitive off-state voltage ratings of 200, 400, and 600 volts. The plastic package design provides not only ease of mounting but also low thermal impedance, which allows operation at high case temperatures and permits reduced heat-sink size.

Features:

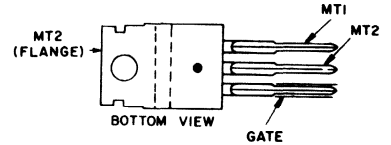
- 120-A peak surge full-cycle current ratings
- Shorted-emitter center-gate design
- Low switching losses
- Low thermal resistance
- Glass-passivated chip for stability
- Package design facilitates mounting on a printed-circuit board

Maximum Ratings, Absolute-Maximum Values:

	2N6342A 2N6346A	2N6343A 2N6347A	2N6344A 2N6348A	
* V_{DROM} * $T_J = -40$ to 110°C	200	400	600	V
* $I_T(RMS)$ $T_C = 80^\circ\text{C}, \theta = 360^\circ$	12	12	12	A
For other conditions	See Fig. 5			
I_{TSM}				
For one full cycle of applied principal voltage				
* 60 Hz (sinusoidal), $T_C = 80^\circ\text{C}$	120	120	120	A
* 50 Hz (sinusoidal), $T_C = 80^\circ\text{C}$	113	113	113	A
For more than one cycle of applied principal voltage	See Fig. 6			
di/dt				
$V_D = V_{DROM}, I_{GT} = 200$ mA, $t_r = 0.1$ μs	100	100	100	A/ μs
i_{2t} (At T_C shown for $I_T(RMS)$, half-sine wave):				
t = 10 ms	64	64	64	A ² s
= 2.5 ms	40	40	40	A ² s
= 0.5 ms	23	23	23	A ² s
= 1 to 8.3 ms	40	40	40	A ² s
* I_{GTM}				
For 1 μs max.	4	4	4	A
* P_{GM} (For 1 μs max., $I_{GTM} \leq 4$ A)	20	20	20	W
* $P_{G(AV)}$	0.5	0.5	0.5	W
* T_{stg}	-40 to 150	-40 to 150	-40 to 150	$^\circ\text{C}$
* T_C	-40 to 110	-40 to 110	-40 to 110	$^\circ\text{C}$
* T_T (During soldering for 10 s max.)	230	230	230	$^\circ\text{C}$

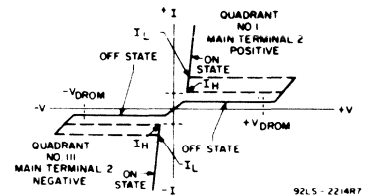
- * In accordance with JEDEC registration data format JC-22 RDF-2.
- For either polarity to main terminal 2 voltage (V_{MT2}) with reference to main terminal 1.
- For either polarity to gate voltage (V_G) with reference to main terminal 1.

TERMINAL CONNECTIONS



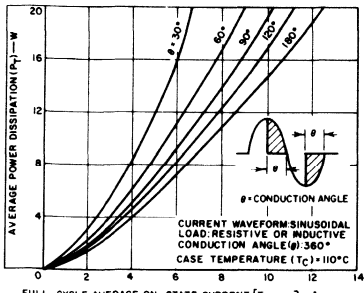
92CS-27718

JEDEC TO-220AB



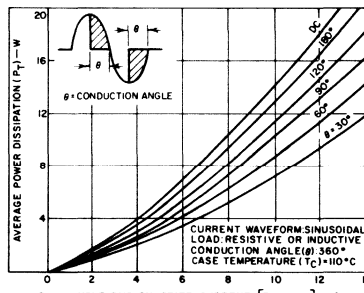
92LS-22487

Fig. 1 - Principal voltage-current characteristic.



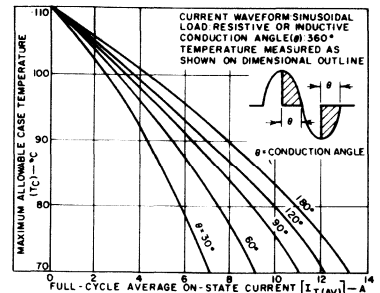
92CS-30364

Fig. 2 - Power dissipation as a function of average on-state current.



92CS-30365

Fig. 3 - Power dissipation as a function of rms on-state current.



92CS-30372

Fig. 4 - Maximum allowable case-temperature as a function of average on-state current.

2N6342A-2N6344A, 2N6346A-2N6348A, (T6000) Series

ELECTRICAL CHARACTERISTICS

At Maximum Ratings Unless Otherwise Specified, and at Indicated Temperatures

CHARACTERISTIC	LIMITS For All Types Except as Specified			UNITS		
	Min.	Typ.	Max.			
	* I_{DROM}^{\bullet} $T_J = 110^{\circ}C$, $V_{DROM} = \text{Max. rated value}$	-	-		2	mA
* V_{TM}^{\bullet} $i_T = 17A$ (peak), $T_C = 25^{\circ}C$	-	1.3	1.75	V		
I_{HO}^{\bullet} Gate open, Initial principal current = 200 mA $v_D = 12V$, $T_C = 25^{\circ}C$ $= -40^{\circ}C$	-	6	40	mA		
* dv/dt^{\bullet} (Commutating) $v_D = V_{DROM}$, $I_{TM} = 17A$, $di/dt = 6.5A/ms$, $T_C = 80^{\circ}C$	-	5	-			
* dv/dt^{\bullet} (Off-State) $v_D = V_{DROM}$, $T_C = 100^{\circ}C$ 2N6342A, 2N6346A 2N6343A, 2N6347A 2N6344A, 2N6348A	100	300	-	V/ μs		
I_{GT}^{\bullet} $v_D = 12V$ (dc), $R_L = 100\Omega$ Mode V_{MT2} V_G $T_C = 25^{\circ}C$	111-	-	-	50	mA	
	1-	+	-	10		
	1-	+	-	6		75
	111+	-	+	25		75
	111-	-	-	-	100	mA
	1-	+	-	-	100	
	1-	+	-	-	125	
	111+	-	+	-	125	
V_{GT}^{\bullet} $v_D = 12V$ (dc), $R_L = 100\Omega$ Mode V_{MT2} V_G $T_C = 25^{\circ}C$	111-	-	-	0.9	2	V
	1-	+	-	1.1	2	
	1-	+	-	0.9	2.5	
	111+	-	+	1.4	2.5	
	111-	-	-	-	2.5	V
	1-	+	-	-	2.5	
	1-	+	-	-	3	
	111+	-	+	-	3	
$v_D = V_{DROM}$, $R_L = 10 k\Omega$ $T_J = 110^{\circ}C$	111-	-	-	0.2	-	V
	1-	+	-	0.2	-	
	1-	+	-	0.2	-	
	111+	-	+	0.2	-	
* t_{gt} $v_D = V_{DROM}$, $I_{GT} = 120 mA$, $t_r = 0.1 \mu s$, $i_T = 17A$ (peak), $T_C = 25^{\circ}C$	-	1.5	2		μs	
* $R_{\theta JC}$	-	-	2		$^{\circ}C/W$	

* In accordance with JEDEC registration data format JC-22 RDF2.

• For either polarity of main terminal 2 voltage (V_{MT2}) with reference to main terminal 1.

• For either polarity of gate voltage (V_G) with reference to main terminal 1.

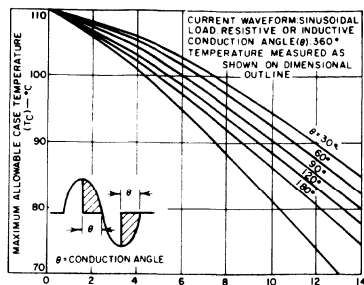


Fig. 5 - Maximum allowable case-temperature as a function of rms on-state current.

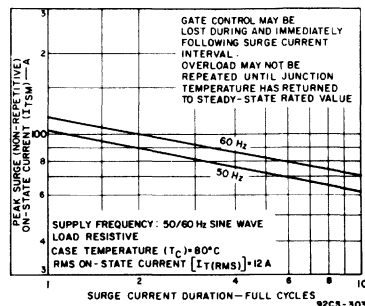


Fig. 6 - Peak surge on-state current as a function of surge current duration.

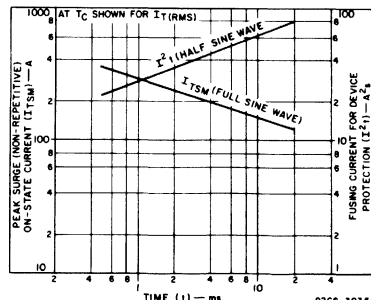


Fig. 7 - Peak surge on-state current and fusing current as a function of time.

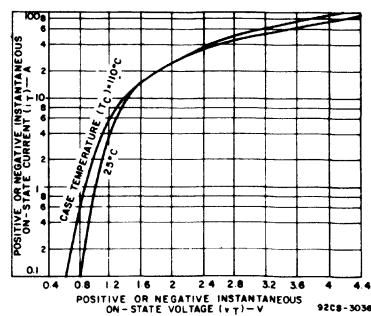


Fig. 8 - On-state current as a function of on-state voltage.

2N6342A-2N6344A, 2N6346A-2N6348A, (T6000) Series

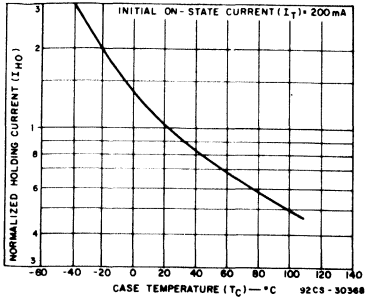


Fig. 9 – Normalized holding current as a function of case temperature.

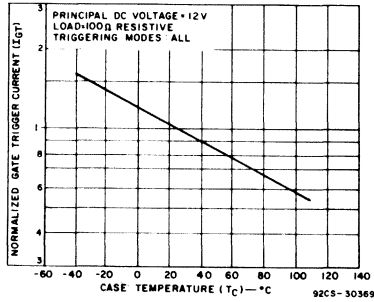


Fig. 10 – Normalized gate trigger current as a function of case temperature.

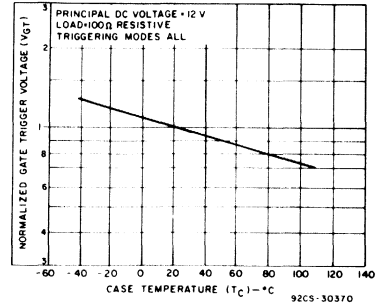


Fig. 11 – Normalized gate trigger voltage as a function of case temperature.

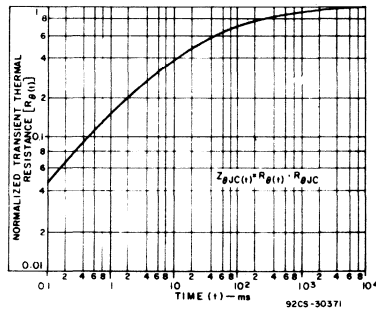


Fig. 12 – Normalized transient thermal resistance as a function of time.

MAC15, MAC15A (T6000) Series

15-A Silicon Triacs

Three-Lead Plastic Types for Power-Control and Power-Switching Applications

The RCA-MAC15 and MAC15A series triacs are gate-controlled full-wave silicon switches utilizing a plastic case with three leads to facilitate mounting on printed-circuit boards. They are intended for the control of ac loads in such applications as motor controls, light dimmers, heating controls, and power-switching systems.

These devices are designed to switch from an off-state to an on-state for either polarity of

applied voltage with positive or negative gate triggering voltages. They have an on-state current rating of 12-A at $T_C = 95^\circ\text{C}$ and 15-A at $T_C = 80^\circ\text{C}$ and repetitive off-state voltage ratings, of 200, 400, and 600 volts.

The plastic package design provides not only ease of mounting but also low thermal impedance, which allows operation at high case temperatures and permits reduced heat-sink size.

Maximum Ratings, Absolute-Maximum Values:

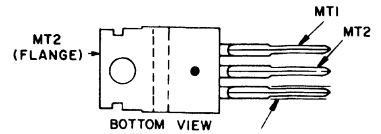
	MAC15-4 MAC15A-4	MAC15-6 MAC15A-6	MAC15-8 MAC15A-8	
V_{DROM}^* $T_J = -40$ to 125°C .	200	400	600	V
$I_{T(RMS)}^{\theta = 360^\circ}$				A
$T_C = 95^\circ\text{C}$		12		A
$T_C = 80^\circ\text{C}$		15		A
For other conditions		See Fig. 3		
I_{TSM}^{\dagger}				A
For one full cycle of applied principal voltage, at current and temperature shown above for $I_{T(RMS)}$				
60 Hz (sinusoidal)		150		A
50 Hz (sinusoidal)		140		A
For more than one cycle of applied principal voltage		See Fig. 4		
di/dt				A/ μs
$v_D = V_{DROM}$, $I_{GT} = 200$ mA, $t_r = 0.1$ μs		100		A/ μs
I_{GTM}^{\ddagger}				A
For 1 μs max.		2		A
P_{GM} (For 1 μs max., $I_{GTM} \leq 4$ A)		20		W
$P_{G(AV)}$		0.5		W
T_{stg}		-40 to 150		$^\circ\text{C}$
T_C		-40 to 125		$^\circ\text{C}$
T_T (During soldering for 10 s max.)		230		$^\circ\text{C}$

- For either polarity of main terminal 2 voltage (V_{MT2}) with reference to main terminal 1.
- For either polarity of gate voltage (V_G) with reference to main terminal 1.

Features:

- 150-A peak surge full-cycle current ratings
- Shorted-emitter center-gate design
- Low switching losses
- Low thermal resistance
- Glass-passivated chip for stability
- Package design facilitates mounting on a printed-circuit board

TERMINAL CONNECTIONS



JEDEC TO-220AB

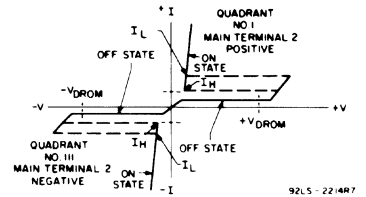


Fig. 1 - Principal voltage-current characteristic.

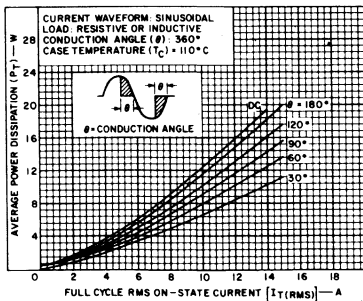


Fig. 2 - Power dissipation as a function of on-state current.

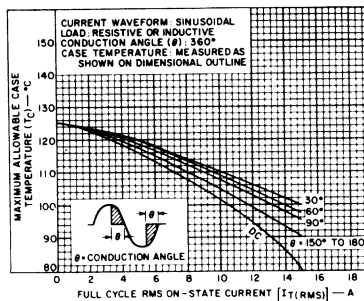


Fig. 3 - Maximum allowable case-temperature as a function of on-state current.

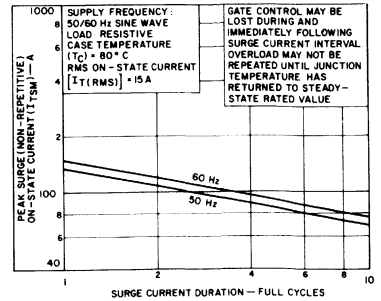


Fig. 4 - Peak surge on-state current as a function of surge current duration.

MAC15, MAC15A (T6000) Series

ELECTRICAL CHARACTERISTICS

At Maximum Ratings Unless Otherwise Specified, and at Indicated Temperatures

CHARACTERISTIC	LIMITS For All Types Except as Specified			UNITS
	Min.	Typ.	Max.	
I_{DROM}^{\bullet} $V_{DROM} = \text{Max. rated value, } T_C = 125^{\circ}\text{C}$	-	-	2	mA
V_{TM}^{\bullet} $T_C = 25^{\circ}\text{C, } i_T = 21\text{A (peak)}$	-	1.3	1.6	V
I_{HO}^{\bullet} Gate open, Initial principal current = 200 mA (dc) $v_D = 12\text{ V, } T_C = 25^{\circ}\text{C}$	-	6	40	mA
dv/dt^{\bullet} (Commutating) $v_D = V_{DROM}, i_T = 21\text{A (peak)}$ $di/dt = 8\text{ A/ms, } T_C = 80^{\circ}\text{C}$	-	5	-	V/ μs
$I_{GT}^{\bullet\bullet}$ $v_D = 12\text{ V (dc), } R_L = 100\ \Omega$ $T_C = 25^{\circ}\text{C}$ Mode V_{MT2} V_G 1+ + + 111- - - 1- + - MAC15A series only 111+ - + MAC15A series only	-	-	50 50 75 75	mA
$V_{GT}^{\bullet\bullet}$ $v_D = 12\text{ V (dc), } R_L = 100\ \Omega$ $T_C = 25^{\circ}\text{C}$ Mode V_{MT2} V_G 1+ + + 111- - - 1- + - MAC15A series only 111+ - + MAC15A series only	-	0.9 1.1 0.9 1.4	2 2 2.5 2.5	V
$T_C = 110^{\circ}\text{C}$ $v_D = V_{DROM}, R_L = 10\ \text{k}\Omega$ 1+ + + 111- - - 1- + - MAC15A series only 111+ - + MAC15A series only	0.2 0.2 0.2 0.2	- - - -	- - - -	
t_{gt} $v_D = V_{DROM}, I_{GT} = 120\text{ mA, } t_r = 0.1\ \mu\text{s, } i_T = 17\text{A (peak)}$ $T_C = 25^{\circ}\text{C}$	-	1.5	2	μs
$R_{\theta JC}$	-	-	2	$^{\circ}\text{C/W}$

- For either polarity of main terminal 2 voltage (V_{MT2}) with reference to main terminal 1.
- For either polarity of gate voltage (V_G) with reference to main terminal 1.

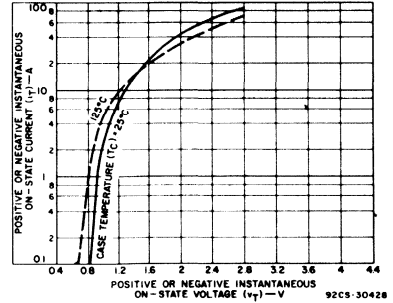


Fig. 5 - On-state current as a function of on-state voltage.

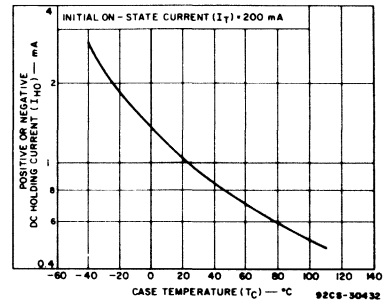


Fig. 6 - DC holding current as a function of case temperature.

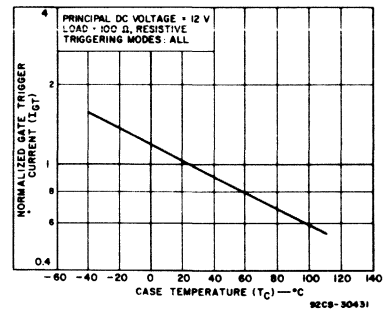


Fig. 7 - Normalized gate trigger current as a function of case temperature.

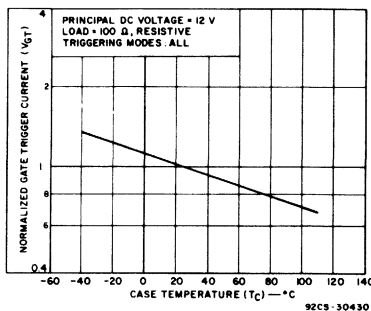


Fig. 8 - Normalized gate trigger voltage as a function of case temperature.

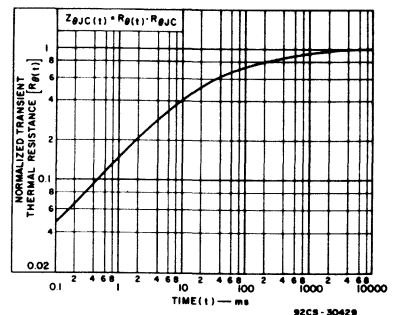


Fig. 9 - Normalized transient thermal resistance as a function of time.

SC149, SC151 (T6000) Series

12-A and 15-A Silicon Triacs

Three-Lead Plastic Types for Power-Control and Power-Switching Applications

The RCA-SC149 and SC151 series triacs are gate-controlled full-wave silicon switches utilizing the RCA VERSAWATT plastic package (JEDEC TO-220AB) with three leads to facilitate mounting on printed-circuit boards. They are intended for the control of ac loads in such applications as motor controls, light dimmers, heating controls, and power-switching systems.

These devices are designed to switch from an off-state to an on-state for either polarity

of applied voltage with positive or negative gate triggering voltages. They have an on-state current rating of 12-A at $T_C = 75^\circ\text{C}$ (SC149 series) and 15-A at $T_C = 80^\circ\text{C}$ (SC151 series) and repetitive off-state voltage ratings, of 200, 400, 500, and 600 volts. The plastic package design provides not only ease of mounting but also low thermal impedance, which allows operation at high case temperatures and permits reduced heat-sink size.

Features:

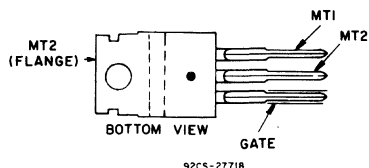
- 120-A peak surge full-cycle current ratings
- Shorted-emitter center-gate design
- Low switching losses
- Low thermal resistance
- Glass-passivated chip for stability
- Package design facilitates mounting on a printed-circuit board

Maximum Ratings, Absolute-Maximum Values:

	SC149B SC151B	SC149D SC151D	SC149E SC151E	SC149M SC151M	
V_{DROM}^* $T_J = -40$ to 100°C	200	400	500	600	V
$I_{T(RMS)}$ $\theta = 360^\circ$					A
For SC149 series, $T_C = 75^\circ\text{C}$		12			A
For SC151 series, $T_C = 80^\circ\text{C}$		15			A
For other conditions		See Fig. 4			
I_{TSM}^*					A
For one full cycle of applied principal voltage, at current and temperature shown above for $I_{T(RMS)}$:					
60 Hz (sinusoidal)		120			A
50 Hz (sinusoidal)		113			A
For more than one cycle of applied principal voltage		See Fig. 5			
di/dt					A/ μs
$v_D = V_{DROM}$, $I_{GT} = 200\text{ mA}$, $t_r = 0.1\ \mu\text{s}$		100			A/ μs
i^2t [At T_C shown for $I_{T(RMS)}$, half-sine wave]:					A^2s
$t = 10\text{ ms}$		64			A^2s
2.5 ms		40			A^2s
0.5 ms		23			A^2s
I_{GTM}^*					A
For $1\ \mu\text{s}$ max.		1			A
P_{GM} (For $1\ \mu\text{s}$ max., $I_{GTM} \leq 4\text{ A}$)		10			W
$P_{G(AV)}$		0.5			W
T_{stg}		-40 to 125			$^\circ\text{C}$
T_C		-40 to 100			$^\circ\text{C}$
T_T (During soldering for 10 s max.)		230			$^\circ\text{C}$

- For either polarity of main terminal 2 voltage (V_{MT2}) with reference to main terminal 1.
- For either polarity of gate voltage (V_G) with reference to main terminal 1.

TERMINAL CONNECTIONS



JEDEC TO-220AB

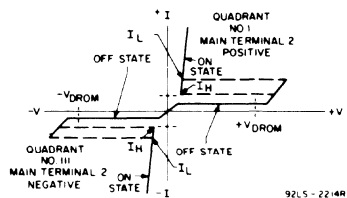


Fig. 1 - Principal voltage-current characteristic.

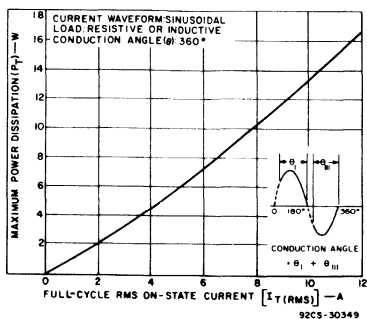


Fig. 2 - Power dissipation as a function of on-state current for SC149 series.

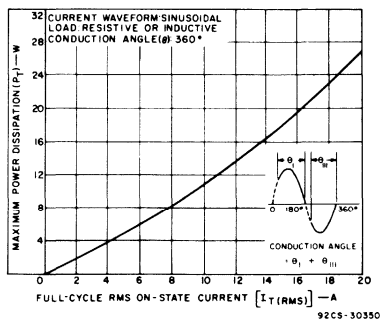


Fig. 3 - Power dissipation as a function of on-state current for SC151 series.

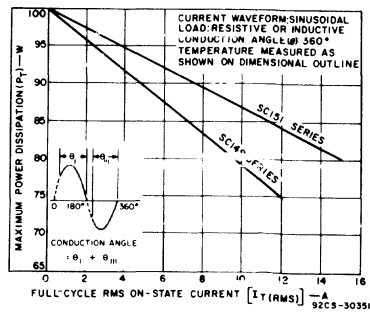


Fig. 4 - Maximum allowable case-temperature as a function of on-state current for both series.

SC149, SC151 (T6000) Series

ELECTRICAL CHARACTERISTICS

At Maximum Ratings Unless Otherwise Specified, and at Indicated Temperatures

CHARACTERISTIC	LIMITS For All Types Except as Specified			UNITS
	Min.	Typ.	Max.	
I_{DROM}^{\bullet} V_{DROM} = Max. rated value, $T_C = 25^{\circ}C$ = $100^{\circ}C$	-	-	0.1 0.5	mA
V_{TM}^{\bullet} $T_C = 25^{\circ}C$, $i_T = 17A$ (peak) SC149 series = $21A$ (peak) SC151 series	-	-	1.65 1.62	V
I_{HO}^{\bullet} Gate open, initial principal current = 500 mA (dc) $v_D = 12V$, $T_C = 25^{\circ}C$ = $-40^{\circ}C$	-	-	50 100	
I_L^{\bullet} $R_{GK} = 100\Omega$, $t_W = 50\mu s$, $t_r = t_f = 5\mu s$, $f = 1kHz$, $T_C = 25^{\circ}C$ Mode V_{MT2} V_G				mA
	1+	+	+	100
	111-	-	-	100
	1-	+	-	200
$T_C = -40^{\circ}C$	1+	+	+	200
	111-	-	-	200
	1-	+	-	400
dv/dt^{\bullet} (Commutating) $v_D = V_{DROM}$, $I_T(RMS)$ = Max. rated value, $di/dt = 6.4 A/ms$, $T_C = 75^{\circ}C$ SC149 series $di/dt = 8.1 A/ms$, $T_C = 80^{\circ}C$ SC151 series			4 4	$V/\mu s$
dv/dt^{\bullet} (Off-State) $v_D = V_{DROM}$, $T_C = 100^{\circ}C$, Exponential voltage rise SC149 series SC151 series			100 100	200 250
I_{GT}^{\bullet} $v_D = 12V$ (dc) $T_C = 25^{\circ}C$ $R_L - \Omega$ Mode V_{MT2} V_G				mA
	100	1+	+	50
	100	111-	-	50
	50	1-	+	50
$T_C = -40^{\circ}C$	50	1+	+	80
	50	111-	-	80
	25	1-	+	80
V_{GT}^{\bullet} $v_D = 12V$ (dc) $T_C = 25^{\circ}C$ $R_L - \Omega$ Mode V_{MT2} V_G				V
	100	1+	+	2.5
	100	111-	-	2.5
	50	1-	+	2.5
$T_C = -40^{\circ}C$	50	1+	+	3.5
	50	111-	-	3.5
	25	1-	+	3.5

See footnotes on top of next page.

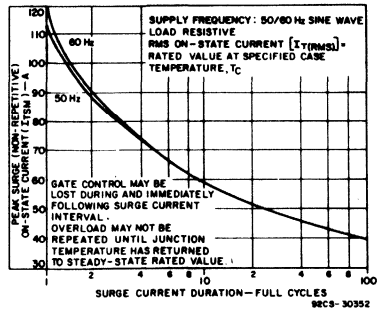


Fig. 5 - Peak surge on-state current as a function of surge current duration.

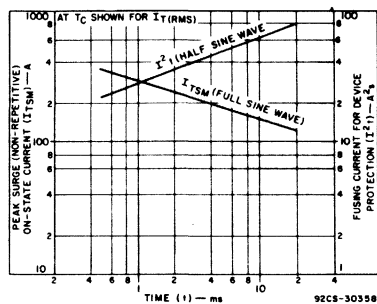


Fig. 6 - Peak surge on-state current and fusing current as a function of time.

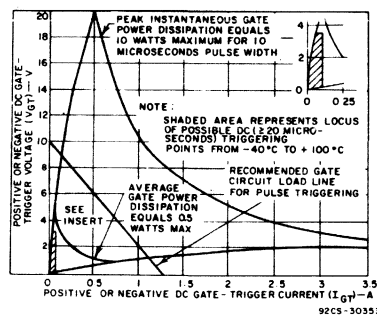


Fig. 7 - Gate pulse characteristics for all triggering modes.

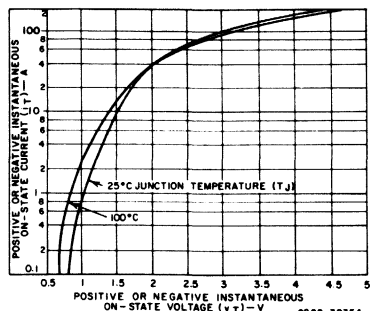


Fig. 8 - On-state current as a function of on-state voltage for SC149 series.

SC149, SC151 (T6000) Series

ELECTRICAL CHARACTERISTICS (Cont'd)

At Maximum Ratings Unless Otherwise Specified, and at Indicated Temperatures

CHARACTERISTIC	LIMITS For All Types Except as Specified			UNITS
	Min.	Typ.	Max.	
V_{GD}^* $v_D = V_{DROM}, R_L = 1k\Omega, T_C = 100^\circ C$ (For all triggering modes)	0.2	—	—	V
t_{gt} $v_D = V_{DROM}, I_{GT} = 80\text{ mA}, t_r = 0.1\ \mu s, i_T = 25\text{ A (peak)}, T_C = 25^\circ C$	—	1.6	2.5	μs
Thermal Characteristics				
$R_{\theta JC}$	—	—	2	$^\circ C/W$
$R_{\theta JA}$	—	—	75	
$R_{\theta JC(ac)}^*$ During ac current conduction				
	SC149 series	—	—	1.52
	SC151 series	—	—	1.1

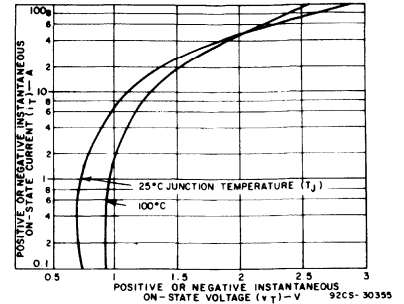


Fig. 9 - On-state current as a function of on-state voltage for SC151 series.

- For either polarity of main terminal 2 voltage (V_{MT2}) with reference to main terminal 1.
- For either polarity of gate voltage (V_G) with reference to main terminal 1.
- * This characteristic is useful in the calculation of junction-temperature rise above T_C for ac current conduction and applies for a 50 or 60 Hz full sine wave of current. It can be calculated with the following formula:

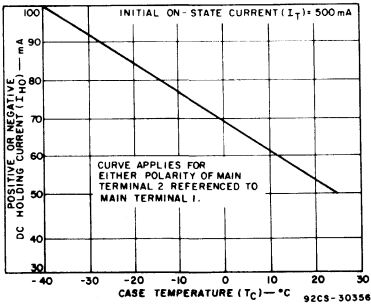


Fig. 10 - DC holding current as a function of case temperature.

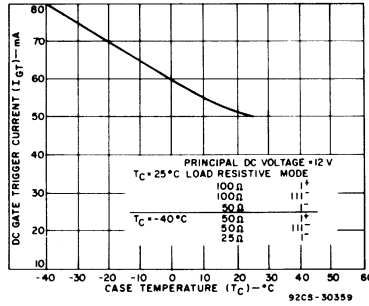


Fig. 11 - DC gate trigger current as a function of case temperature.

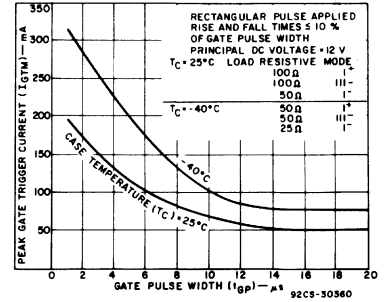


Fig. 12 - Peak gate trigger current as a function of gate pulse width.

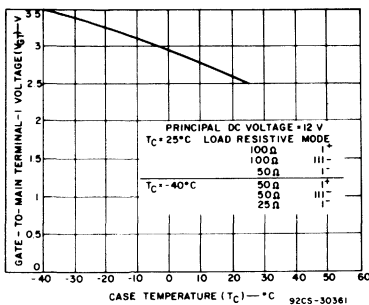


Fig. 13 - DC gate trigger voltage as a function of case temperature.

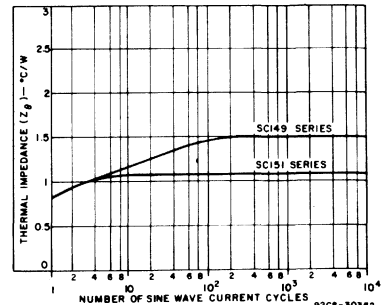


Fig. 14 - Thermal impedance as a function of sine-wave current cycles.

TIC236, TIC246 (T6000) Series

12-A and 16-A Silicon Triacs

Three-Lead Plastic Types for Power-Control and Power-Switching Applications

The RCA-TIC236 and TIC246 series triacs are gate-controlled full-wave silicon switches utilizing a plastic case with three leads to facilitate mounting on printed-circuit boards. They are intended for the control of ac loads in such applications as motor controls, light dimmers, heating controls, and power-switching systems.

These devices are designed to switch from an off-state to an on-state for either polarity

of applied voltage with positive or negative gate triggering voltages. They have an on-state current rating of 12-A and 16-A at T_C of 70°C and repetitive off-state voltage ratings of 200 and 400 volts.

The plastic package design provides not only ease of mounting but also low thermal impedance, which allows operation at high case temperatures and permits reduced heat-sink size.

Features:

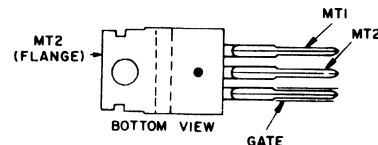
- 100-A and 125-A peak surge full-cycle current ratings
- Shorted-emitter center-gate design
- Low switching losses
- Low thermal resistance
- Glass-passivated chip for stability
- Package design facilitates mounting on a printed-circuit board

Maximum Ratings, Absolute-Maximum Values:

	TIC236B TIC246B	TIC236D TIC246D	
V_{DROM}^* $T_J = -40$ to $110^\circ C$	200	400	V
$I_{T(RMS)}$ $T_C = 70^\circ C, \theta = 360^\circ$			A
For TIC236 series	12		A
For TIC246 series	16		A
For other conditions	See Fig. 2		
I_{TSM}^*			
For one full cycle of applied principal voltage, at current and temperature shown above for $I_{T(RMS)}$:			
60 Hz (sinusoidal) TIC236 series	100		A
TIC246 series	125		A
50 Hz (sinusoidal) TIC236 series	90		A
TIC246 series	115		A
For more than one cycle of applied principal voltage	See Fig. 3 and 4		
di/dt	100		A/ μs
$V_D = V_{DROM}; I_{GT} = 200$ mA, $t_r = 0.1$ μs			
i^2t (At T_C shown for $I_{T(RMS)}$):	TIC236 Series	TIC246 Series	
$t = 20$ ms	55	85	A ² s
2.5 ms	28	42	A ² s
0.5 ms	16	25	A ² s
I_{GTM}^*			A
For 1 μs max.	1		A
P_{GM} (For 1 μs max., $I_{GTM} \leq 4$ A)	16		W
$P_G(AV)$	0.5		W
T_{stg}	-40 to 125		°C
T_C	-40 to 110		°C
T_T	130		°C

- For either polarity of main terminal 2 voltage (V_{MT2}) with reference to main terminal 1.
- For either polarity of gate voltage (V_G) with reference to a main terminal 1.

TERMINAL CONNECTIONS



JEDEC TO-220AB

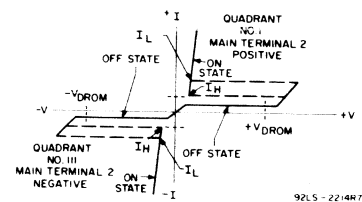


Fig. 1 - Principal voltage-current characteristic.

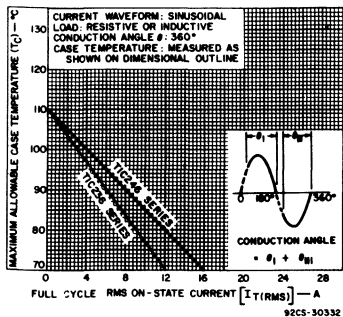


Fig. 2 - Maximum allowable case temperature as a function of on-state current.

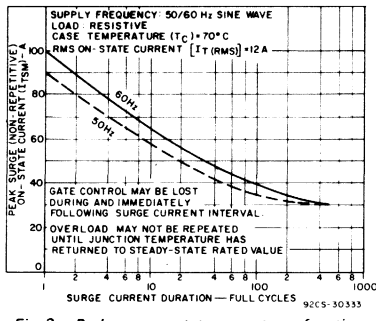


Fig. 3 - Peak surge on-state current as a function of surge current duration for TIC236 series.

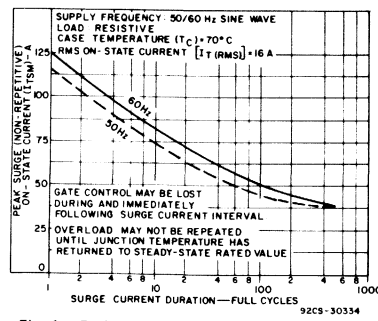


Fig. 4 - Peak surge on-state current as a function of surge current duration for TIC246 series.

TIC236, TIC246 (T6000) Series

ELECTRICAL CHARACTERISTICS

At Maximum Ratings Unless Otherwise Specified, and at Indicated Temperatures

CHARACTERISTIC	LIMITS For All Types Except as Specified			UNITS
	Min.	Typ.	Max.	
I_{DROM}^{\bullet} $T_C = 110^{\circ}C$, $V_{DROM} = \text{Max. rated value}$	—	—	5	mA
V_{TM}^{\bullet} $T_C = 25^{\circ}C$, $i_T = 17A$ (peak) = 22.5A (peak)	—	—	2.1 1.7	V TIC236 series TIC246 series
I_{HO}^{\bullet} Gate open, Initial principal current = 150 mA (dc), $v_D = 12V$, $T_C = 25^{\circ}C$	—	—	50	mA
I_L^{\bullet} $I_{GT} = I_{GT} \text{ Max.}$, $t_w = 20 \mu s$, $t_r = t_f \leq 15 \text{ ns}$, $f = 1 \text{ kHz}$, $T_C = 25^{\circ}C$	—	20	—	
dv/dt^{\bullet} (Commutating) $v_D = V_{DROM}$, $I_T(RMS) = \text{Max. rated value}$, $T_C = 70^{\circ}C$ $di/dt = 6.4 \text{ A/ms}$ TIC236 series = 8.5 A/ms TIC246 series	4	10	—	V/ μs
dv/dt^{\bullet} (Off-State) $v_D = V_{DROM}$, $T_C = 100^{\circ}C$, Exponential voltage rise TIC236 series TIC246 series	100	300	—	
$I_{GT}^{\bullet\bullet}$ $v_D = 12V$ (dc) $R_L = 30 \Omega$ $T_C = 25^{\circ}C$	Mode	V_{MT2}	V_G	mA
	I ⁺	+	+	
	III ⁻	—	—	
	I ⁻	+	—	
	III ⁺	—	+	
$V_{GT}^{\bullet\bullet}$ $v_D = 12V$ (dc), $R_L = 30 \Omega$, $T_C = 25^{\circ}C$	—	1.2	2.5	V
t_{gt} $v_D = V_{DROM}$, $I_{GT} = 80 \text{ mA}$, $t_r = 0.1 \mu s$, $i_T = 25 \text{ A}$ (peak), $T_C = 25^{\circ}C$	—	1.6	2.5	μs

Thermal Characteristics

$R_{\theta JC}$	TIC236 series TIC246 series	— —	2 1.9	$^{\circ}C/W$
$R_{\theta JA}$		—	62.5	$^{\circ}C/W$

• For either polarity of main terminal 2 voltage (V_{MT2}) with reference to main terminal 1.

■ For either polarity of gate voltage (V_G) with reference to main terminal 1.

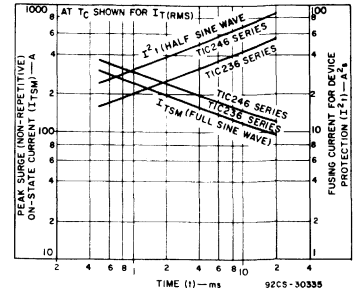


Fig. 5 — Peak surge on-state current and fusing current as a function of time.

T6400, T6401, T6410, T6411, T6420, T6421 Series (Includes 2N5441-2N5446, 2N5806-2N5809)

25-A, 30-A and 40-A Silicon Triacs

For General Purpose AC Power Switching Application
All 30-A and 40-A Triacs

For Control-Systems Application in Airborne and Ground Support Type Equipment
25-A, 400-Hz Triacs (2N5806-2N5809)

These RCA triacs are gate-controlled full-wave silicon ac switches. They are designed to switch from an off-state to an on-state for either polarity of applied voltage with positive or negative gate triggering voltages.

These triacs are intended for control of ac loads in applications such as heating controls, motor controls, arc-welding equipment, light dimmers, and power switching

systems. They can also be used in air-conditioning and photocopying equipment.

Types 2N5441-43 and T6401 series employ a press-fit package. Types 2N5444-46, 2N5806-09, and T6411 series employ a stud package. T6421 series and T6421 series employ an isolated-stud package.

Features:

- di/dt Capability = 100 A/μs
- Shorted-Emitter, Center-Gate Design
- Low Switching Losses
- Low On-State Voltage at High Current Levels
- Low Thermal Resistance

Additional Features for the 2N5806-2N5809:

- Available in JAN or JANTX Screening
- Commutating dv/dt capability Characterized at 400 Hz

MAXIMUM RATINGS, Absolute-Maximum Values:

For Operation with Sinusoidal Supply Voltage at Frequencies up to 50/400 Hz and with Resistive or Inductive Load.

*REPETITIVE PEAK OFF-STATE VOLTAGE: V_{DROM}

Gate open, $T_J = -65$ to 110°C

RMS ON-STATE CURRENT (Conduction angle = 360°): $I_{T(RMS)}$

Case temperature

- $T_C = 70^\circ\text{C}$ (2N5441-43, —Press-fit types)
- 65°C (2N5444-46, —Stud types)
- 60°C (T6420 series — Isolated-stud types)
- 65°C (T6401 series — Press-fit types)
- 60°C (T6411 series — Stud types)
- 55°C (T6421 series — Isolated-stud types)
- 80°C (2N5806-2N5809 — Stud types)

For other conditions:

PEAK SURGE (NON-REPETITIVE) ON-STATE CURRENT I_{TSM}

For one cycle of applied principal voltage; T_C as above

- 60 Hz (sinusoidal; 30-A & 40-A types) 300 A
- 50 Hz (sinusoidal; 30-A & 40-A types) 265 A
- 400 Hz (sinusoidal; 25-A types) 370 A
- 60 Hz (sinusoidal; 25-A types) 200 A
- 50 Hz (sinusoidal; 25-A types) 170 A

For more than one cycle of applied principal voltage

RATE OF CHANGE OF ON-STATE CURRENT di/dt

$V_{DM} = V_{DROM}$; $I_{GT} = 200$ mA, $t_r = 0.1$ μs

FUSING CURRENT (For Triac Protection) i^2t

(At T_C shown for $I_{T(RMS)}$)

- $t = 20$ ms (30-A & 40-A types) 500 A^2s
- 2.5 ms (30-A & 40-A types) 250 A^2s
- 0.5 ms (30-A & 40-A types) 145 A^2s
- 20 ms (25-A types) 240 A^2s
- 2.5 ms (25-A types) 110 A^2s
- 0.5 ms (25-A types) 65 A^2s

*PEAK GATE TRIGGER CURRENT I_{GTM}

For 1 μs max.; See Fig. 15 (30-A and 40-A types only)

*GATE POWER DISSIPATION

PEAK (For 10 μs max.; $I_{GTM} \leq 4$ A, —30-A & 40-A types) P_{GM}

AVERAGE (30-A & 40-A types) P_{GM}

(25-A types; $t = 16.6$ ms) $P_{G(AV)}$

*TEMPERATURE RANGE T_{stg}

Storage (30-A & 40-A types) T_{stg}

(25-A types) T_C

Operating (Case) 40-A types T_C

—30-A types T_C

—25-A types T_C

*TERMINAL TEMPERATURE T_T

During soldering for 10 s max. (terminals and case)

30-A & 40-A types T_s

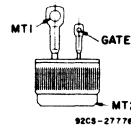
25-A types T_s

STUD TORQUE: Recommended T_s

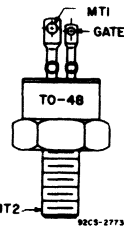
Maximum (DO NOT EXCEED)

40-A	2N5441	2N5442	—	2N5443	
	—	2N5444	2N5445	—	2N5446
	T6420F	T6420B	T6420D	T6420E	T6420M
	T6401F	T6401B	T6401D	T6401E	T6401M
30-A	T6411F	T6411B	T6411D	T6411E	T6411M
	T6421F	T6421B	T6421D	T6421E	T6421M
25-A	—	2N5806	2N5807	2N5808	2N5809
V_{DROM}	50	200	400	500	600
$I_{T(RMS)}$					
I_{TSM}					
di/dt					
i^2t					
I_{GTM}					
P_{GM}					
$P_{G(AV)}$					
T_{stg}					
T_C					
T_T					
T_s					

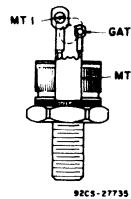
TERMINAL CONNECTIONS



2N5441-43 T6401 series
Press-Fit Types



2N5444-46,
2N5806-09, T6411 series
Stud Types



T6420 series,
T6421 series
Isolated-Stud Types

WARNING: The ceramic of the isolated stud package contains beryllium oxide. Do not crush, grind, or abrade this part because the dust resulting from such action may be hazardous if inhaled. Disposal should be by burial.

* In accordance with JEDEC registration data format (JS-14, RDF 2) filed for the JEDEC (2N Series) types.

■ For either polarity of main terminal 2 voltage (V_{MT2}) with reference to main terminal 1.

■ For either polarity of gate voltage (V_G) with reference to main terminal 1.

▲ For temperature measurement reference point, see Dimensional Outline.

T6400, T6401, T6410, T6411, T6420, T6421 Series (Includes 2N5441-2N5446, 2N5806-2N5809)

ELECTRICAL CHARACTERISTICS, At Maximum Ratings Otherwise Specified and at Indicated Case Temperature (T_C)

CHARACTERISTICS	SYMBOL	LIMITS			UNITS
		MIN.	TYP.	MAX.	
Peak Off-State Current: Gate open, $V_{DROM} =$ Max. rated value $T_J = 110^\circ\text{C}$, (40-A types) $T_J = 100^\circ\text{C}$, (30-A types) $T_J = 115^\circ\text{C}$, (25-A types)	I_{DROM}	—	0.2	4*	mA
Maximum On-State Voltage: For $I_T = 100$ A (peak), $T_C = 25^\circ\text{C}$, (40-A types) For $I_T = 58$ A (peak), $T_C = 25^\circ\text{C}$, (40-A types) For $I_T = 100$ A (peak), $T_C = 25^\circ\text{C}$, (30-A types) = 35 A (peak), pulse width ≤ 1 ms, duty cycle $\leq 2\%$, $I_G = 150$ mA, $T_C = 25^\circ\text{C}$ (25-A types) ..	V_{TM}	—	1.7 1.5 2.1	2 1.85* 2.5	V
DC Holding Current: Gate open, initial principal current = 500 mA (dc), $v_D = 12$ V: $T_C = 25^\circ\text{C}$ (30-A & 40-A types) $T_C = 25^\circ\text{C}$ (25-A types) $T_C = -65^\circ\text{C}$ (40-A types) $T_C = -40^\circ\text{C}$ (25-A types) For other case temperatures	I_{HO}	—	25 30 45	60 75 100* 100*	mA
Critical Rate of Rise of Commutation Voltage: $v_D = V_{DROM}$, $I_T(\text{RMS}) = 40$ A, commutating $di/dt = 22$ A/ms, gate unenergized, $T_C = 70^\circ\text{C}$ (40-A, Press-fit types) $T_C = 85^\circ\text{C}$ (40-A, Stud-types) $T_C = 60^\circ\text{C}$ (40-A, Isolated-stud types)	dv/dt	—	5*	30	V/ μ s
$v_D = V_{DROM}$, $I_T(\text{RMS}) = 30$ A, commutating $di/dt = 16$ A/ms, gate unenergized, $T_C = 85^\circ\text{C}$ (30-A, Press-fit types) $T_C = 60^\circ\text{C}$ (30-A, Stud types) $T_C = 55^\circ\text{C}$ (30-A, Isolated-stud types)		—	3	20	
$v_D = V_{DROM}$, $I_T(\text{RMS}) = 25$ A, commutating $di/dt = 88$ A/ms, gate unenergized $T_C = 80^\circ\text{C}$ (25-A, Stud types)		—	5	—	
Critical Rate-of-Rise of Off-State Voltage: For $v_D = V_{DROM}$, exponential voltage rise, gate open $T_C = 110^\circ\text{C}$ (40-A types): 2N5441, 2N5444, T6420B 2N5442, 2N5445, T6420D 2N5443, 2N5446, T6420M $T_C = 100^\circ\text{C}$ (30-A types): T6401B, T6411B, T6421B T6401D, T6411D, T6421D T6401M, T6411M, T6421M $T_C = 115^\circ\text{C}$ (25-A types)	dv/dt	—	50*	200	V/ μ s
—		—	30*	150	
—		—	20*	100	
DC Gate-Trigger Current: $v_D = 12$ V (dc) $R_L = 30\Omega$ $T_C = 25^\circ\text{C}$ Mode V_{MT2} V_G I* positive positive (40-A & 30-A types) (25-A types) III- negative negative (40-A & 30-A types) (25-A types) I- positive negative (40-A & 30-A types) (25-A types) III+ negative positive (40-A & 30-A types) (25-A types) $v_D = 12$ V (dc) $R_L = 30\Omega$ $T_C = -65^\circ\text{C}$ Mode V_{MT2} V_G I* positive positive III- negative negative } 40-A I- positive negative } types III+ negative positive } only $v_D = 12$ V (dc) $R_L = 25\Omega$ $T_C = 40^\circ\text{C}$ Mode V_{MT2} V_G I* positive positive III- negative negative } 25-A I- positive negative } types III+ negative positive } only	I_{GT}	—	15 20 20 50 30 80 40 100	50 80 50 80 80 80 80 150	mA
—		—	—	125*	
—		—	—	125* 240* 240*	
DC Gate-Trigger Voltage: $v_D = 12$ V (dc), $R_L = 30\Omega$, $T_C = 25^\circ\text{C}$ (30-A & 40-A types) $T_C = -65^\circ\text{C}$ (40-A types only) For other case temperatures $v_D = V_{DROM}$, $R_L = 125\Omega$, $T_C = 110^\circ\text{C}$ (40-A types) $T_C = 100^\circ\text{C}$ (30-A types)	V_{GT}	—	0.2 1.8 0.2	2.5 3.4*	V

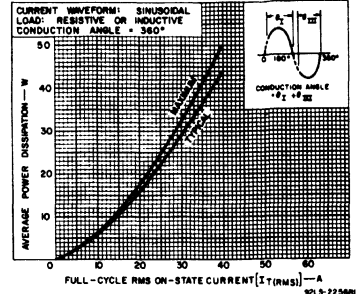


Fig. 1 — Power dissipation vs. on-state current for 2N5441-46, and T6420 series.

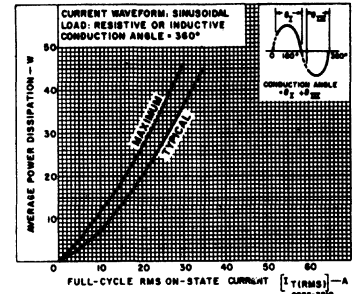


Fig. 2 — Power dissipation vs. on-state current for T6401, T6411, T6421 series.

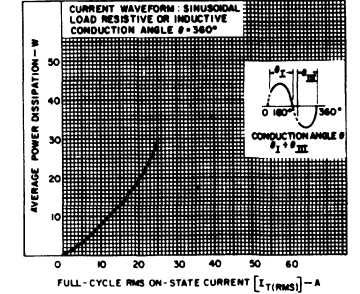


Fig. 3 — Power dissipation vs. on-state current for 2N5806-2N5809.

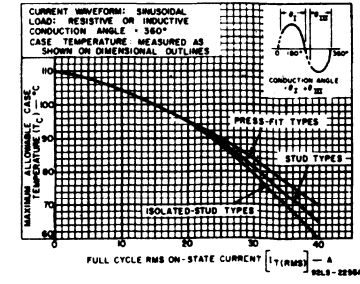


Fig. 4 — Maximum allowable case temperature vs. on-state current for 2N5441-46, and T6420 series.

T6400, T6401, T6410, T6411, T6420, T6421 Series (Includes 2N5441-2N5446, 2N5806-2N5809)

ELECTRICAL CHARACTERISTICS, At Maximum Ratings Otherwise Specified and at Indicated Case Temperature (T_C)

CHARACTERISTICS	SYMBOL	LIMITS			UNITS
		MIN.	TYP.	MAX.	
DC Gate-Trigger Voltage: $\bullet\bullet$ $V_D = 12\text{ V (dc)}$, $R_L = 25\ \Omega$ Triggering Modes I ⁺ , III ⁺ , I ⁻ (25-A types), $T_C = 25^\circ\text{C}$ $T_C = -40^\circ\text{C}$ Triggering Modes III ⁺ (25-A types), $T_C = 25^\circ\text{C}$ $V_D = 12\text{ V (dc)}$, $R_L = 1\text{ k}\Omega$ Triggering Modes I ⁺ , III ⁺ , I ⁻ (25-A types): $T_C = 115^\circ\text{C}$	V_{GT}	-	2 2.6 3	2.5 4* 4	V
Gate-Controlled Turn On Time: (Delay Time + Rise Time) $V_D = V_{DROM}$, $I_{GT} = 200\text{ mA}$, $t_r = 0.1\ \mu\text{s}$, $I_T = 60\text{ A (peak)}$, $T_C = 25^\circ\text{C}$ (40-A types) $V_D = V_{DROM}$, $I_{GT} = 200\text{ mA}$, $t_r = 0.1\ \mu\text{s}$, $I_T = 45\text{ A (peak)}$, $T_C = 25^\circ\text{C}$ (30-A types) $V_D = V_{DROM}$, $I_{GT} = 150\text{ mA}$, $t_r = 0.1\ \mu\text{s}$, $I_T = 60\text{ A (peak)}$, $T_C = 25^\circ\text{C}$ (25-A types)	t_{gt}	-	1.7 1.7	3 3	μs
Thermal Resistance, Junction-to-Case: Steady-State Press-fit types Stud types Stud types (25-A types only) Isolated-stud types Transient (Press-fit & stud types) See Fig. 24	$R_{\theta JC}$	-	-	0.8* 0.9* 1.23* 1	$^\circ\text{C/W}$
Thermal Resistance, Junction-to-Ambient Steady-State (25-A types only)	$R_{\theta JA}$	-	-	50*	$^\circ\text{C/W}$

* In accordance with JEDEC registration data format (JES-14, RDF 2) field for the JEDEC (2N Series) types.
 \bullet For either polarity of main terminal 2 voltage (V_{M2}) with reference to main terminal 1.
 \bullet For either polarity of gate voltage (V_G) with reference to main terminal 1.

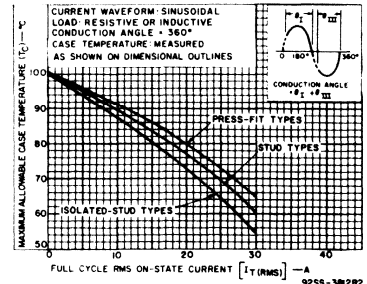


Fig. 5 - Maximum allowable case temperature vs. on-state current for T6401, T6411, T6421 series.

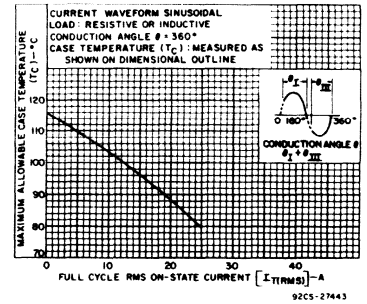


Fig. 6 - Maximum allowable case temperature vs. on-state current for 2N5806-2N5809.

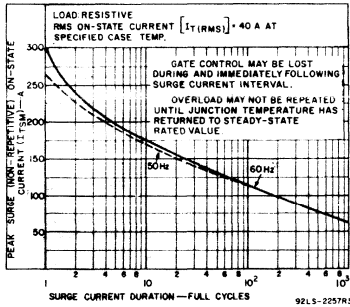


Fig. 7 - Peak surge on-state current vs. surge current duration for 2N5441-46, and T6420 series.

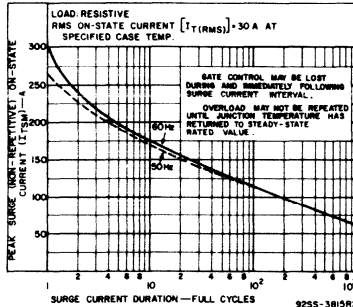


Fig. 8 - Peak surge on-state current vs. surge current duration for T6401, T6411, T6421 series.

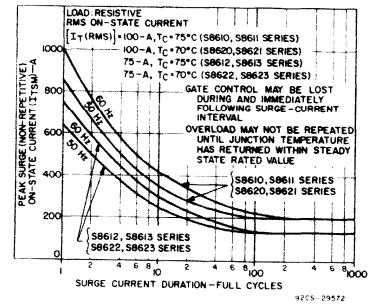


Fig. 9 - Peak surge on-state current vs. surge current duration for 2N5806-2N5809.

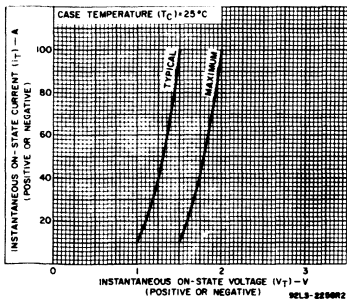


Fig. 10 - On-state current vs. on-state voltage for 2N5441-46, and T6420 series.

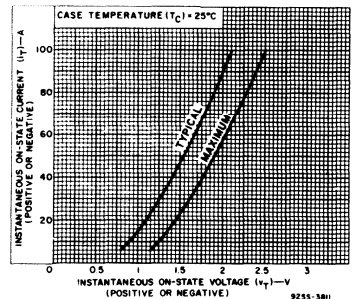


Fig. 11 - On-state current vs. on-state voltage for T6401, T6411, T6421 series.

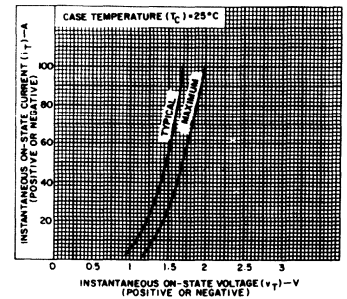


Fig. 12 - On-state current vs. on-state voltage for 2N5806-2N5809.

T6400, T6401, T6410, T6411, T6420, T6421 Series (Includes 2N5441-2N5446, 2N5806-2N5809)

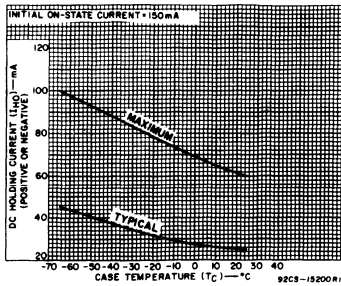


Fig. 13 - DC holding current vs. case temperature for 2N5441-46, T6420, T6401, T6411, T6421 series.

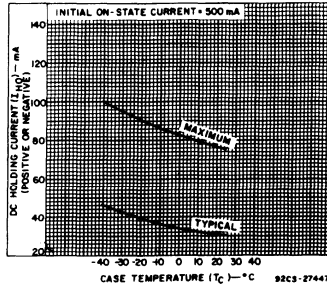


Fig. 14 - DC holding current vs. case temperature for 2N5806-2N5809 series.

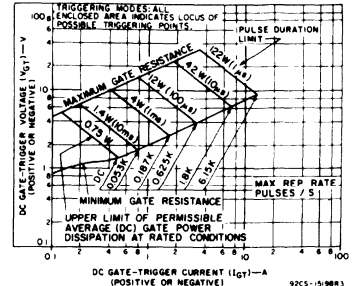


Fig. 15 - Gate-trigger characteristics and limiting conditions for determination of permissible gate-trigger pulses for 2N5441-46, T6420, T6401, T6411, T6421 series.

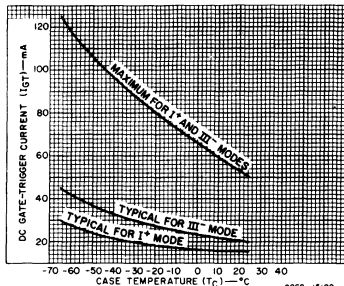


Fig. 16 - DC gate-trigger current vs. case temperature (I^+ & III^- modes) for 2N5441-46, T6420, T6401, T6411, T6421 series.

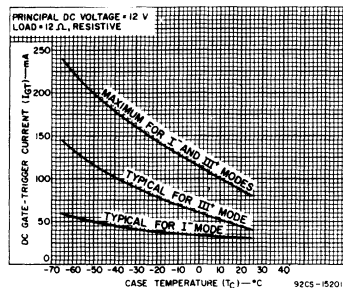


Fig. 17 - DC gate-trigger current vs. case temperature (I^- & III^+ modes) for 2N5441-46, T6420, T6401, T6411, T6421 series.

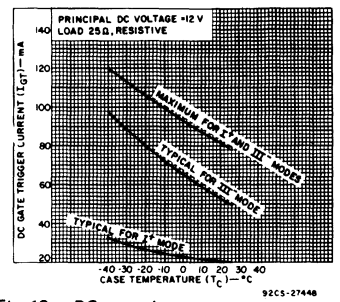


Fig. 18 - DC gate-trigger current vs. case temperature (I^+ & III^- modes) for 2N5806-2N5809.

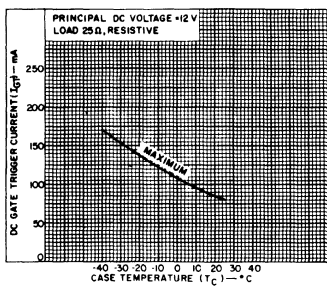


Fig. 19 - DC gate-trigger current vs. case temperature (I^- mode) for 2N5806-2N5809.

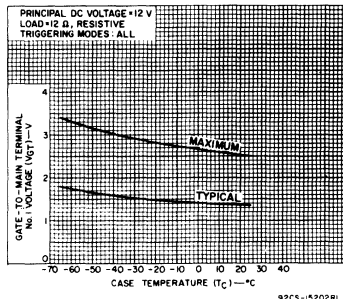


Fig. 20 - DC gate-trigger voltage vs. case temperature for 2N5441-46, T6420, T6401, T6411, T6421 series.

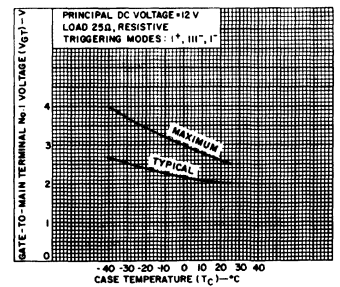


Fig. 21 - DC gate-trigger voltage vs. case temperature for 2N5806-2N5809.

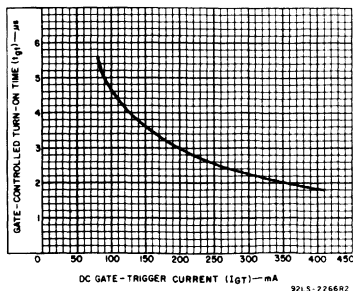


Fig. 22 - Turn-on time vs. gate-trigger current for 2N5441-46, T6420, T6401, T6411, T6421 series.

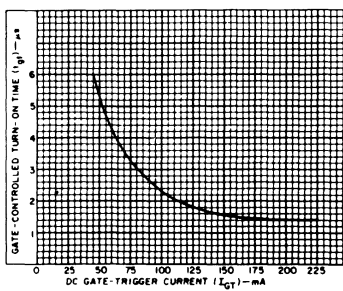


Fig. 23 - Typical turn-on time vs. gate-trigger current for 2N5806-2N5809.

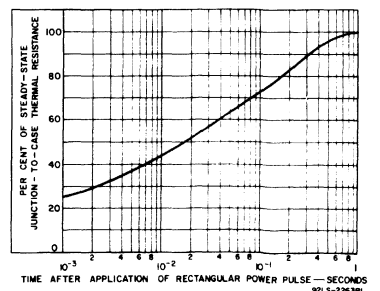


Fig. 24 - Transient junction-to-case thermal resistance vs. time for press-fit and stud types.

T6404, T6405, T6414, T6415 Series

400-Hz, 25 & 40-A Silicon Triacs

For Control-Systems Application in Airborne and Ground-Support Type Equipment

These RCA triacs are gate-controlled full-wave silicon ac switches. They are designed to switch from an off-state to an on-state for either polarity of applied voltage with positive or negative gate triggering voltages.

They are intended for operation at 400 Hz with resistive or inductive loads and nominal line voltages of 115 and

208 V RMS sine wave and repetitive peak off-state voltages of 200 V and 400 V.

These triacs exhibit commutating voltage (dv/dt) capability at high commutating current (di/dt). They can also be used in 60-Hz applications where high commutating capability is required.

MAXIMUM RATINGS, Absolute-Maximum Values:

For Operation with Sinusoidal Supply Voltage at 400 Hz and with Resistive or Inductive Load.

REPETITIVE PEAK OFF-STATE VOLTAGE:^a

Gate open, T_J = -50 to 110° C

RMS ON-STATE CURRENT (Conduction Angle = 360°):

Case temperature

T _C = 85° C (T6405 Series)	25	A
80° C (T6415 Series)	25	A
70° C (T6404 Series)	40	A
65° C (T6414 Series)	40	A

For other conditions

PEAK SURGE (NON-REPETITIVE) ON-STATE CURRENT:

For one cycle of applied principal voltage, T_C as above

400 Hz (sinusoidal)

60 Hz (sinusoidal)

50 Hz (sinusoidal)

For more than one cycle of applied principal voltage

RATE-OF-CHANGE OF ON-STATE CURRENT:

V_{DM} = V_{DOM}, I_{GT} = 200 mA, t_r = 0.1 μs

FUSING CURRENT (for Triac Protection):

T_J = -50 to 110° C, t = 1.25 to 10 ms

PEAK GATE-TRIGGER CURRENT:^b

For 1 μs max. (See Fig. 7)

GATE POWER DISSIPATION:

Peak (For 10 μs max., I_{GMT} ≤ 4 A (peak), (See Fig. 7))

Average

TEMPERATURE RANGE:^a

Storage

Operating (Case)

TERMINAL TEMPERATURE (During soldering):

For 10 s max. (terminals and case)

STUD TORQUE:

Recommended

Maximum (DO NOT EXCEED)

^a For either polarity of main terminal 2 voltage (V_{M2T2}) with reference to main terminal 1.

^b For either polarity of gate voltage (V_G) with reference to main terminal 1.

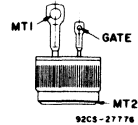
^c For temperature measurement reference point, see Dimensional Outline.

	T6404B	T6404D	T6404E	T6406B	T6406D	T6406E	T6414B	T6414D	T6415D
V _{DOM}	200	400	500	—	—	—	—	—	—
I _{T(RMS)}	25	40	50	—	—	—	—	—	—
I _{TSM}	600	300	285	—	—	—	—	—	—
di/dt	100	270	—	—	—	—	—	—	—
I _{GT}	12	—	—	—	—	—	—	—	—
P _{GM}	42	—	—	—	—	—	—	—	—
P _{G(AV)}	0.75	—	—	—	—	—	—	—	—
T _{stg}	-50 to 150	—	—	—	—	—	—	—	—
T _C	-50 to 110	—	—	—	—	—	—	—	—
T _T	225	—	—	—	—	—	—	—	—
τ _s	35	36	—	—	—	—	—	—	—

Features:

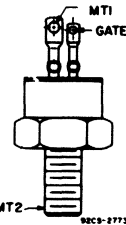
- RMS On-State Current — I_{T(RMS)} = 25A: T6405 and T6415 Series = 40A: T6404 and T6414 Series
- Commutating dv/dt Capability Characterized at 400 Hz
- Shorted-Emitter Center-Gate Design
- di/dt Capability = 100 A/μs

TERMINAL CONNECTIONS



T6404 Series
T6405 Series

Press-fit



T6414 Series
T6415 Series

Stud

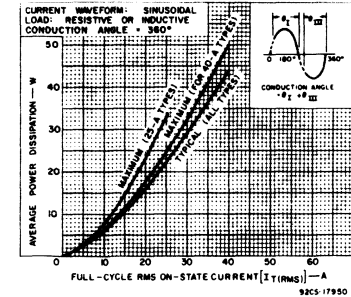


Fig. 1—Power dissipation vs. on-state current.

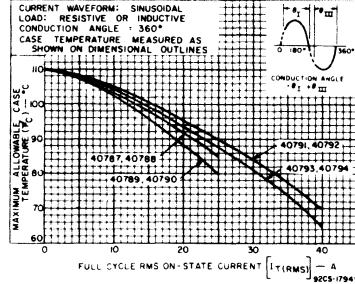


Fig. 2—Maximum allowable case temperature vs. on-state current.

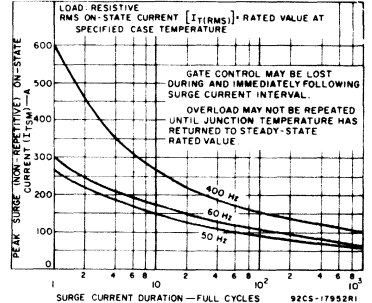


Fig. 3—Peak surge on-state current vs. surge current duration.

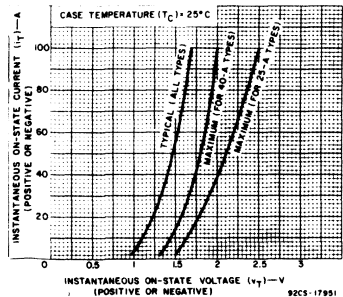


Fig. 4—On-state current vs. on-state voltage.

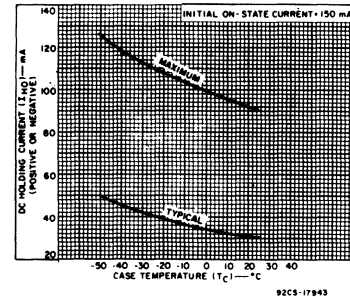


Fig. 5—DC holding current vs. case temperature.

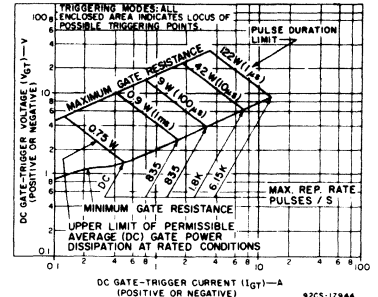


Fig. 6—Gate-trigger characteristics and limiting conditions for determination of permissible gate-trigger pulses.

T8411, T8421 Series

60-A Silicon Triacs

Stud and Isolated Stud "Overmolded" Packages
For General Purpose AC Power Switching

The RCA-T8411 and T8421 series triacs are gate-controlled full-wave silicon ac switches. They are designed to switch from an off-state to an on-state for either polarity of applied voltage with positive or negative-gate-triggering voltages. The T8411 and T8421 series are 60-A triacs.

These triacs are intended for control of ac loads in applications such as heating con-

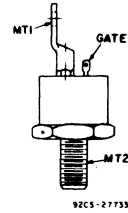
trols, motor controls, arc-welding equipment, light dimmers, and power switching systems. They can also be used in air-conditioning and photocopying equipment.

The T8411 series employ a stud "overmolded" package. The T8421 series employ an isolated-stud "overmolded" pack-

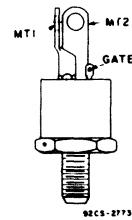
Features:

- di/dt Capability = 300 A/ μ s
- Shorted-Emitter Center-Gate Design
- Low Switching Losses
- Low On-State Voltage at High Current Levels
- Low Thermal Resistance
- 2.5 kV RMS Isolation (Isolated-Stud Types)

TERMINAL CONNECTIONS



T8411 Series
Stud "overmolded" types



T8421 Series
Isolated-Stud "overmolded" types

MAXIMUM RATINGS, Absolute-Maximum Values:

For Operation with Sinusoidal Supply Voltage at Frequencies Up to 50/60 Hz and with Resistive or Inductive Load.

	T8411F	T8411B	T8411D	T8411M	T8411E	
	T8421F	T8421B	T8421D	T8421M	T8421E	
V_{DROM}^{Δ} Gate open, $T_J = -40$ to $110^{\circ}C$	50	200	400	600	500	V
$I_{T(RMS)}^{\Delta}$ ($\theta = 360^{\circ}$) $T_C = 80^{\circ}C$ (T8411 series - Stud types) $T_C = 75^{\circ}C$ (T8421 series - Isolated-Stud types)			60			A
For other conditions			60			A
			See Fig. 2			
I_{TSM}^{Δ} For one cycle of applied principal voltage			700			A
60 Hz (sinusoidal), $I_{T(RMS)}$ and T_C as above for T8411, 21 series			600			A
50 Hz (sinusoidal), $I_{T(RMS)}$ and T_C as above for T8411, 21 series			See Fig. 3			
For more than one cycle of applied principal voltage						
di/dt			300			A/ μ s
$V_{DM} = V_{DROM} - I_{GT} = 300$ mA, $t_r = 0.1$ μ s						A/ μ s
I^2t [At T_C shown for $I_{T(RMS)}$] $t = 20$ ms			2700			A ² s
T8411, T8421 series						
$t = 2.5$ ms			1350			A ² s
T8411, T8421 series						
$t = 0.5$ ms			800			A ² s
T8411, T8421 series						
I_{GTM}^{Δ} For 10 μ s max. (See Fig. 6)			7			A
P_{GM}^{Δ} Peak (For 10 μ s max., $I_{GTM} \leq 7$ A (peak). (See Fig. 6)			42			W
$P_{G(AV)}$			0.75			W
T_{stg}			-40 to 150			$^{\circ}C$
T_C			-40 to 110			$^{\circ}C$
T_s^{Δ} During soldering for 10 ms maximum (terminals and case)			225			$^{\circ}C$
T_s Recommended			125			in-lb
			1.44			kgf-m
			150			in-lb
			1.73			kgf-m
Maximum (DO NOT EXCEED)						

Δ For either polarity of main terminal 2 voltage (V_{MT2}) with reference to main terminal 1.
 Δ For either polarity of gate voltage (V_G) with reference to main terminal 1.
 Δ For temperature measurement reference point, see Dimensional Outline.

WARNING: The ceramic of the isolated stud package contains beryllium oxide. Do not crush, grind, or abrade this part because the dust resulting from such action may be hazardous if inhaled. Disposal should be by burial.

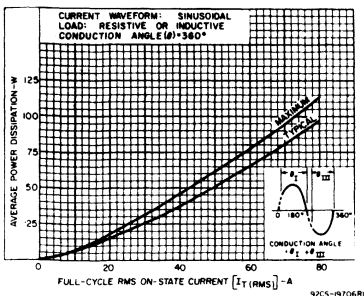


Fig. 1 - Power dissipation vs. on-state current for T8411 and T8421 series.

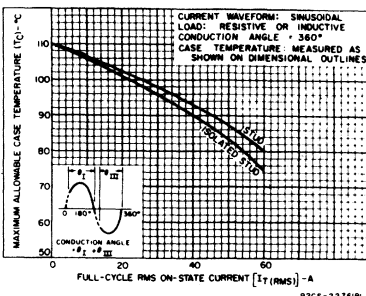


Fig. 2 - Maximum allowable case temperature vs. on-state current for T8411 and T8421 series.

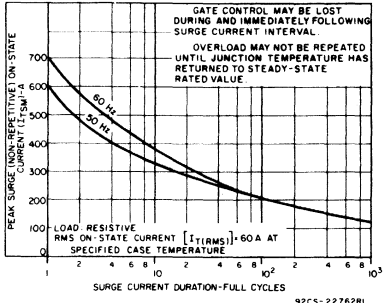


Fig. 3 - Peak surge on-state current vs. surge current duration for T8411 and T8421 series.

T8411, T8421 Series

ELECTRICAL CHARACTERISTICS, At Maximum Ratings Unless Otherwise Specified and at Indicated Case Temperature (T_C)

CHARACTERISTIC	LIMITS			UNITS
	FOR ALL TYPES Except as Specified			
	Min.	Typ.	Max.	
I_{DROM}^A Gate open, $T_J = 110^\circ C$, $V_{DROM} =$ Max. rated value	—	0.4	4	mA
V_{TM}^A $I_T = 200$ A (peak), $T_C = 25^\circ C$ $I_T = 100$ A (peak), $T_C = 25^\circ C$	—	1.75	2	V
I_{HO}^A Gate open, Initial principal current = 500 mA (dc), $v_D = 12$ V $T_C = 25^\circ C$ $T_C = -40^\circ C$ For other case temperatures See Fig. 5	—	40	60	mA
dv/dt (Commutating) ^A $v_D = V_{DROM}$, I_T (RMS) = 60 A, commutating $dv/dt = 32$ A/ms, gate unenergized $T_C = 80^\circ C$ (Stud types - T8411 series) $T_C = 75^\circ C$ (Isolated stud types - T8421 series)	3	10	—	V/ μ s
dv/dt (Off State) ^A $v_D = V_{DROM}$, exponential voltage rise, gate open, $T_C = 110^\circ C$ T8411B, T8421B T8411D, T8421D T8411M, T8421M	50	200	—	V/ μ s
$I_{GT}^{A,B}$ $v_D = 12$ V dc, $R_L = 30\Omega$, $T_C = 25^\circ C$ Mode V_{MT2} V_G I^+ positive positive III^- negative negative I^- positive negative III^+ negative positive $v_D = 12$ V dc, $R_L = 30\Omega$, $T_C = -40^\circ C$ Mode V_{MT2} V_G I^+ positive positive III^- negative negative I^- positive negative III^+ negative positive For other case temperatures See Figs. 7 & 8	—	20	75	mA
	—	40	75	
	—	40	150	
	—	100	150	
	—	35	150	
	—	80	150	
	—	100	400	
	—	280	400	
$V_{GT}^{A,B}$ $v_D = 12$ V dc, $R_L = 30\Omega$, $T_C = 25^\circ C$ For other case temperatures See Fig. 9	—	1.35	2.5	V
t_{gt} : $v_D = V_{DROM}$, $I_{GT} = 300$ mA, $t_r = 0.1 \mu s$, $T_C = 25^\circ C$, $I_T = 85$ A(peak) (T8411, T8421 series)	—	1.2	2.5	μs
$R_{\theta JC}$: Steady-State Stud types Isolated-stud types Transient See Fig. 11	—	—	0.35	$^\circ C$
	—	—	0.4	

- ▲ For either polarity of main terminal 2 voltage (V_{MT2}) with reference to main terminal 1.
- For either polarity of gate voltage (V_G) with reference to main terminal 1.
- For temperature measurement reference point, see Dimensional Outline.

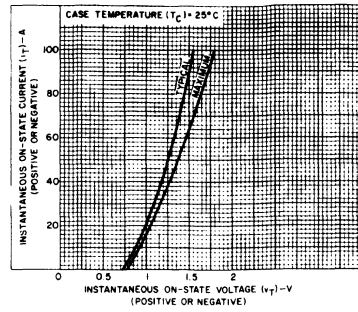


Fig. 4 - On-state current vs. on-state voltage for T8411 and T8421 series.

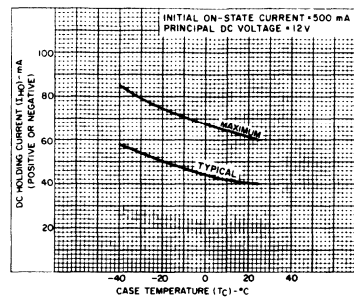


Fig. 5 - DC holding current vs. case temperature for T8411 and T8421 series.

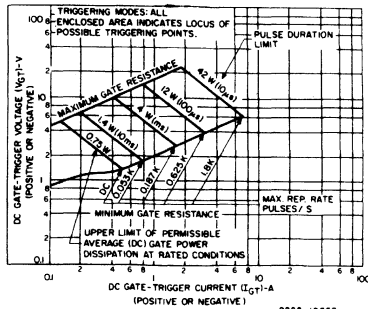


Fig. 6 - Gate-trigger characteristics and limiting conditions for determination of permissible gate-trigger pulses for T8411 and T8421.

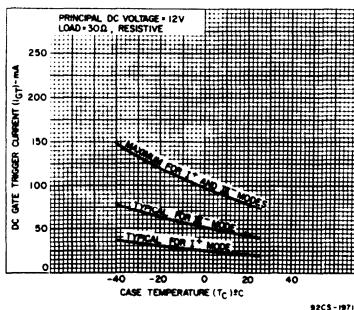


Fig. 7 - DC gate-trigger current vs. case temperature (I^+ and III^- modes) for T8411 and T8421 series.

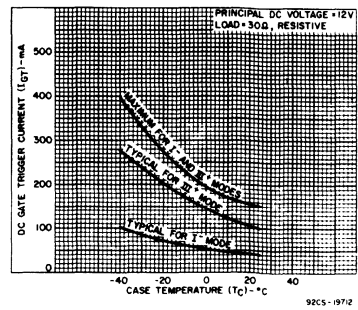


Fig. 8 - DC gate-trigger current vs. case temperature (I^- and III^+ modes) for T8411 and T8421 series.

T8411, T8421 Series

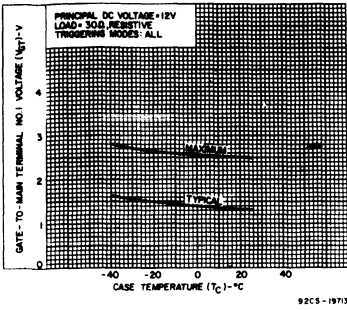


Fig. 9 - DC gate-trigger voltage vs. case temperature for T8411 and T8421 series.

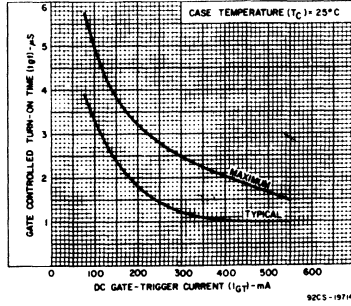


Fig. 10 - Turn-on time vs. gate-trigger current for T8411 and T8421 series.

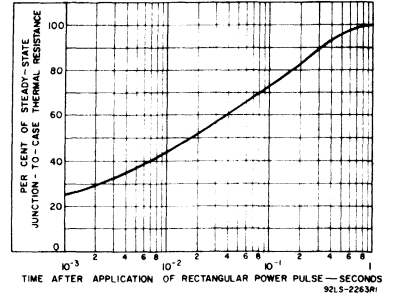


Fig. 11 - Transient junction-to-case thermal resistance vs. time for T8411 and T8421 series.

Zero-Voltage-Switched Types

2.5-40 A, 100-600 V Silicon Triacs for Use With IC Zero-Voltage Switches

For Power-Control and Switching Applications at 50-60 Hz with RCA-CA3058, CA3059, or CA3079 IC as Trigger Circuits

The triacs listed below are gate-controlled full-wave ac switches intended for load-control applications. They are especially useful in ac circuits for heating controls (proportional or on-off), lamp switching, motor switching, and a wide variety of other power-control applications.

These devices have gate characteristics which assure that an RCA-CA3058, CA3059, or CA3079 integrated circuit can supply sufficient drive current to trigger them over their full operating-temperature range (-40°C to +85°C).

The RCA-CA3058, CA3059, and CA3079 are monolithic silicon integrated-circuit zero-voltage switches which can operate directly from the ac line. They are designed to drive the triac gate directly and provide the gating signal at zero-voltage crossings for minimum radio-frequency interference.

These triacs have rms on-state current ratings that range from 2.5 to 40 amperes, and repetitive off-state voltage ratings from 100 to 600 volts. They are supplied in a variety of packages.

RATINGS AND CHARACTERISTICS

All types, at case temperature (T_C) = 25°C, I⁺ and III⁺ triggering modes,[▲]
 I_{GT} = 45 mA max., V_{GT} = 1.5 V max.

Type No.	Rep. Peak Off-State Voltage V_{DROM} (V)	RMS On-State Current I_T (RMS) at Case Temp. (°C)		Typ. DC Holding Current at 25°C, I_{HO} (mA)	Package	For additional data, see Basic Family Types*
T2306A	100	2.5	70	6	Mod. TO-5	T2300
T2306B	200	2.5	70	6		
T2306D	400	2.5	70	6		
T2316A	100	2.5	70	6	Mod. TO-5 on Heat Radiator	T2310
T2316B	200	2.5	70	6		
T2316D	400	2.5	70	6		
T2506B	200	6	80	15	TO-220AB	T2500
T2506D	400	6	80	15		
T2706B	200	6	75	15	TO-66	T2700
T2706D	400	6	75	15		
T2716B	200	6	75	15	TO-66 with Heat Radiator	T2710
T2716D	400	6	75	15		
T2806B	200	8	80	15	TO-220AB	T2800
T2806C	300	8	80	15		
T2806D	400	8	80	15		
T2806M	600	8	80	15		
T2856B	200	8	75	15	Isolated-Tab TO-220AB	T2850
T2856C	300	8	75	15		
T2856D	400	8	75	15		
T4106B	200	15	80	20	Press-fit	T4100
T4106D	400	15	80	20		
T4106M	600	15	80	20		
T4107B	200	10	85	15	Press-fit	T4101
T4107D	400	10	85	15		
T4107M	600	10	85	15		
T4116B	200	15	80	20	Stud	T4110
T4116D	400	15	80	20		
T4116M	600	15	80	20		
T4117B	200	10	85	15	Stud	T4111
T4117D	400	10	85	15		
T4117M	600	10	85	15		
T4126B	200	15	75	20	Isolated Stud	T4120
T4126D	400	15	75	20		
T4126M	600	15	75	20		
T4127B	200	10	85	15	Isolated Stud	T4121
T4127D	400	10	85	15		
T4127M	600	10	85	15		
T6406B	200	40	70	45	Press-fit	T6404
T6406D	400	40	70	45		
T6406E	500	40	70	45		
T6406M	600	40	70	45		
T6407B	200	30	65	25	Press-fit	T6401
T6407D	400	30	65	25		
T6407E	500	30	65	25		
T6407M	600	30	65	25		
T6426B	200	40	60	25	Isolated Stud	T6420
T6426D	400	40	60	25		
T6426M	600	40	60	25		
T6427B	200	30	55	25	Isolated Stud	T6420
T6427D	400	30	55	25		
T6427M	600	30	55	25		

Technical information on RCA-CA3058, CA3059, and CA3079 is contained in bulletin File No. 490. For detailed application information, see Application Note ICAN-6182, "Features and Application of RCA Integrated-Circuit Zero-Voltage Switches".

WARNING: The ceramic of the isolated stud package contains beryllium oxide. Do not crush, grind, or abrade this part because the dust resulting from such action may be hazardous if inhaled. Disposal should be by burial.

[▲] A triac driven directly from the output terminal of the CA3058, CA3059, or CA3079 should be characterized for operation in the I⁺ or III⁺ triggering mode, i.e., with positive gate current (current flows into the gate for both polarities of the applied ac voltage).

* Except for gate characteristics, data for basic family types also apply to the types listed in this chart.

Silicon Controlled Rectifiers (SCR's)

Technical Data

C106, C107, C108 Series

4-A Sensitive-Gate Silicon Controlled Rectifiers

For Power-Switching and Control Applications

The RCA-C106, C107, and C108 series of sensitive-gate silicon controlled rectifiers are designed for switching ac and dc currents. These SCR's are divided into the three different series according to gate sensitivity. The types within each series differ in their voltage ratings; the voltage ratings are identified by suffix letters in the type designations.

These SCR's have microampere gate-current requirements which permit operation with low-level logic circuits. They can be used for lighting, power-switching, and motor-speed controls, and for gate-current amplification for driving larger SCR's.

All types in each series utilize the JEDEC-TO-202AB (RCA VERSATAB) plastic package.

Features:

- Microampere gate sensitivity
- 600-V capability
- 5-A (rms) on-state current ratings
- 30-A peak surge capability
- Glass-passivated chip for stability
- Low thermal resistances
- Surge capability curve
- Package and formed-lead options available

MAXIMUM RATINGS, Absolute Maximum Values:

V_{RSXM} $R_{GK} = 1000 \Omega, T_C = 40 \text{ to } 110^\circ\text{C}$	}			
V_{DSXM} $R_{GK} = 1000 \Omega, T_C = 40 \text{ to } 110^\circ\text{C}$				
V_{RRXM} $R_{GK} = 1000 \Omega, T_C = 40 \text{ to } 110^\circ\text{C}$				
V_{DRXM} $R_{GK} = 1000 \Omega, T_C = 40 \text{ to } 110^\circ\text{C}$				
$I_T(AV)$ ($T_C = 45^\circ\text{C}, \theta = 180^\circ$)				
$I_T(RMS)$ ($T_C = 45^\circ\text{C}, \theta = 180^\circ$)				
$I_T(DC)$ ($T_C = 70^\circ\text{C}$)				
I_{TSM} For one cycle of applied principal voltage, $T_C = 45^\circ\text{C}$				
60 Hz (sinusoidal)				
50 Hz (sinusoidal)				
For more than one cycle of applied principal voltage				
I_{GM} ($t = 10 \mu\text{s}$)				
V_{GRM} di/dt				
$V_{DM} = V_{DROM}, I_{GT} = 1 \text{ mA}, t_r = 0.5 \mu\text{s}, T_C = 110^\circ\text{C}$				
I^2t [At T_C shown for $I_T(RMS)$]:				
$t = 10 \text{ ms}$				
8.33 ms				
1 ms				
P_{GM} (For 10 μs max.)				
$P_{G(AV)}$ (Averaging time = 10 ms max.)				
T_{stg}				
T_C				
T_T (During soldering for 10 s max.)				

C106Y	C106A	C106C	C106E	
C107Y	C107A	C107C	C107E	
C108Y	C108A	C108C	C108E	
C106Q	C106F	C106B	C106D	C106M
C107Q	C107F	C107B	C107D	C107M
C108Q	C108F	C108B	C108D	C108M
25	50	75	125	250 400 500 600 700
V				
15	30	50	100	200 300 400 500 600
V				
	C106	C107	C108	
	Series	Series	Series	
	2.2	2	3.3	A
	3.5	3.14	5	A
	2.6	2.4	4	A
	20	15	30	A
	18.5	14	28	A
	See Fig. 11			
	0.2			A
	6			V
	100			A/ μs
	1.77	1	4	A^2s
	1.67	0.94	3.75	A^2s
	0.82	0.46	1.85	A^2s
	0.5			W
	0.1			W
	-40 to +150			$^\circ\text{C}$
	-40 to +110			$^\circ\text{C}$
	250			$^\circ\text{C}$

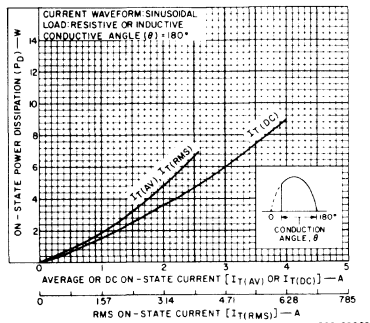
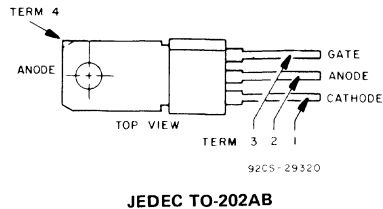


Fig. 1 — Power dissipation as a function of average dc, or rms on-state current for C106 series.

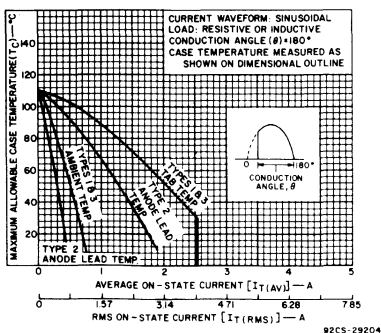


Fig. 2 — Maximum allowable case temperature as a function of average or rms on-state current for C106 series.

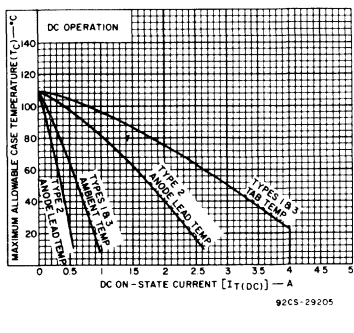


Fig. 3 — Maximum allowable case temperature as a function of dc on-state current for C106 series.

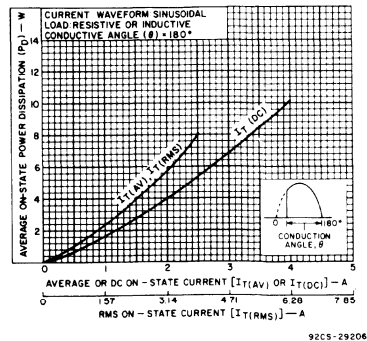


Fig. 4 — Power dissipation as a function of average, dc, or rms on-state current for C107 series.

C106, C107, C108 Series

ELECTRICAL CHARACTERISTICS

CHARACTERISTIC	LIMITS			UNITS
	FOR ALL TYPES UNLESS OTHERWISE SPECIFIED			
	Min.	Typ.	Max.	
I_{DRXM} or I_{RRXM} : $V_D = V_{DRXM}$ or $V_R = V_{RRXM}$, $R_{GK} = 1000 \Omega$ $T_C = 25^\circ C$ $T_C = 110^\circ C$	—	0.1 10	10 100	μA
V_T : For $i_T = 4 A$ and $T_C = 25^\circ C$ (See Fig. 13) C106 Series For $i_T = 5 A$ and $T_C = 25^\circ C$ (See Fig. 13) C108 Series	—	1.25 —	2.2 2.5 1.35	V
i_{HX} : $R_{GK} = 1000 \Omega$, $V_D = 12 V$, $i_T(\text{INITIAL}) = 50 mA$, $T_C = 25^\circ C$: All Series	—	1.7	3	mA
i_{LX} : $R_{GK} = 1000 \Omega$, $V_D = 12 V$, $T_C = 25^\circ C$: C106, C108 Series ($i_{GT} = 200 \mu A$) C107 Series ($i_{GT} = 500 \mu A$)	—	1.8 —	4 4	mA
dv/dt : $V_D = V_{DRXM}$, $R_{GK} = 1000 \Omega$, Exponential rise, $T_C = 110^\circ C$	—	8	—	V/ μs
i_{GT} : $V_D = 12 V$ dc, $R_L = 30 \Omega$, $T_C = 25^\circ C$: C106, C108 Series C107 Series For other case temperatures.	—	30 —	200 500	μA
V_{GT} : $V_D = 12 V$ dc, $R_L = 30 \Omega$, $T_C = 25^\circ C$ For other case temperatures.	—	0.5	0.8	V
t_{gt} : $V_D = V_{DRXM}$, $i_T = 1 A$, $R_{GK} = 1000 \Omega$, $i_{GT} = 1 mA$, Rise Time = $0.1 \mu s$, $T_C = 25^\circ C$	—	1.7	2.5	μs
t_q : $V_D = V_{DRXM}$, $i_T = 1 A$, $R_{GK} = 1000 \Omega$, Pulse Duration = $50 \mu s$, $dv/dt = 5 V/\mu s$, $di/dt = -10 A/\mu s$, $i_{GT} = 1 mA$ at turn-on, $T_C = 110^\circ C$	—	30	100	μs
$R_{\theta JC}$	—	—	8	$^\circ C/W$
$R_{\theta JA}$	—	—	60	$^\circ C/W$

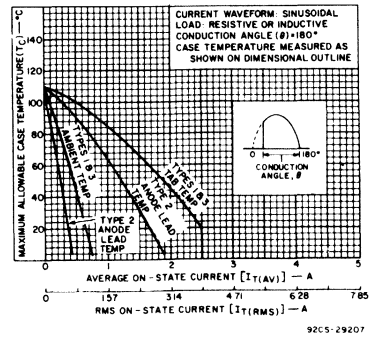


Fig. 5 - Maximum allowable case temperature as a function of average or rms on-state current for C107 series.

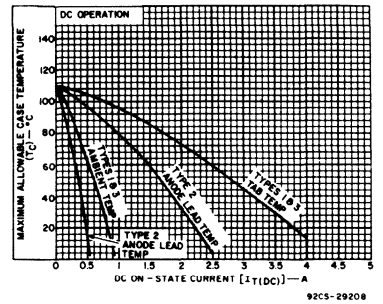


Fig. 6 - Maximum allowable case temperature as a function of dc on-state current for C107 series.

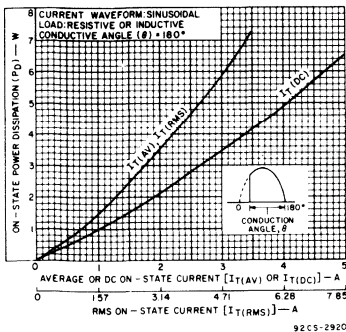


Fig. 7 - Power dissipation as a function of average, dc, or rms on-state current for C108 series.

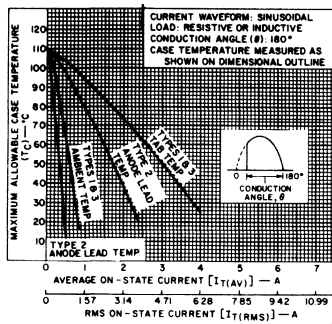


Fig. 8 - Maximum allowable case temperature as a function of average or rms on-state current for C108 series.

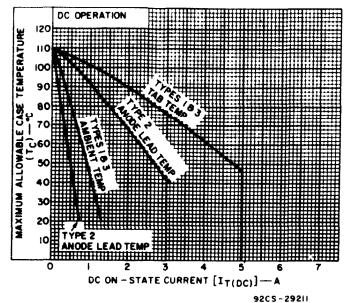


Fig. 9 - Maximum allowable case temperature as a function of dc on-state current for C108 series.

C106, C107, C108 Series

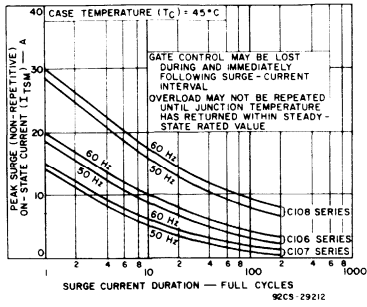


Fig. 10 - Peak surge on-state current as a function of surge current duration.

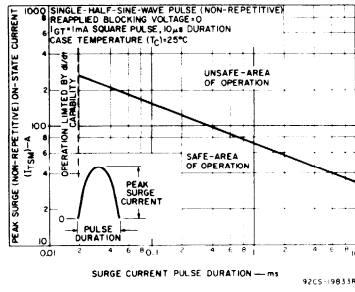


Fig. 11 - Surge capability without reapplied blocking voltage for all series.

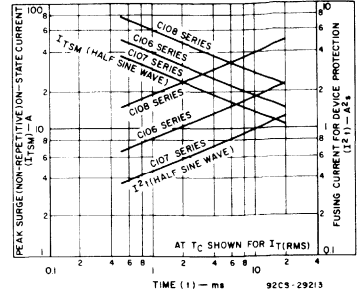


Fig. 12 - Peak surge on-state current and fusing current as a function of time.

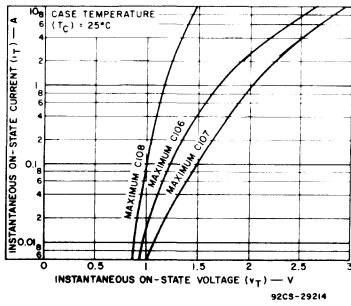


Fig. 13 - Maximum instantaneous on-state current as a function of on-state voltage.

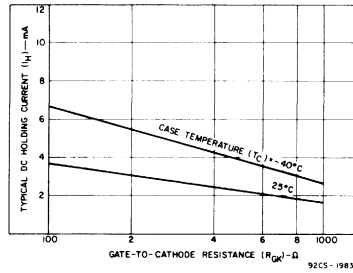


Fig. 14 - DC holding current as a function of gate-cathode resistance for the C106 series.

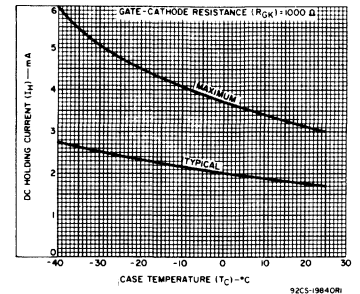


Fig. 15 - DC holding current as a function of case temperature for the C106 series.

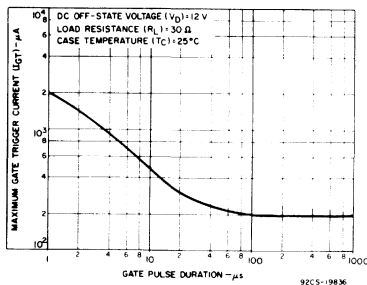


Fig. 16 - Maximum gate trigger current as a function of pulse duration for types in the C106 series.

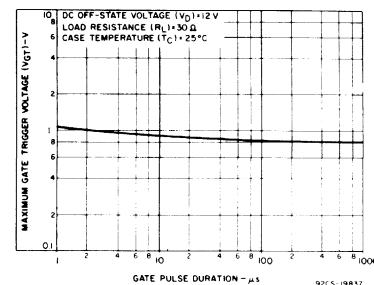


Fig. 17 - Maximum gate trigger voltage as a function of gate pulse duration for types in the C106 series.

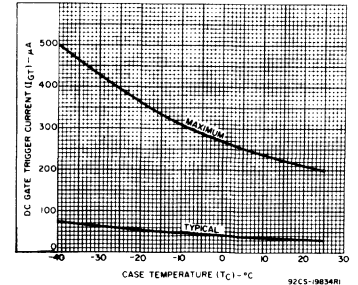


Fig. 18 - DC gate trigger current as a function of case temperature for C106 and C108 series.

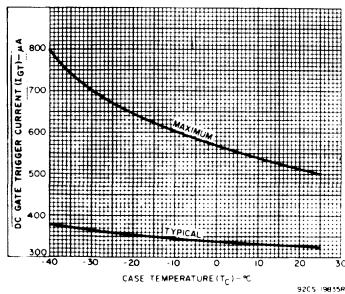


Fig. 19 - DC gate trigger current as a function of case temperature for C107 series.

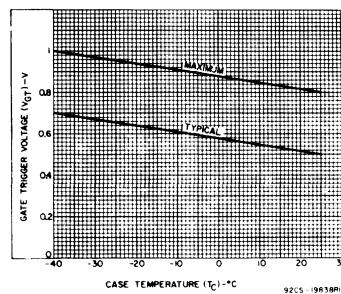


Fig. 20 - Gate trigger voltage as a function of case temperature for all series.

S106, S107 Series

4-A Sensitive-Gate Silicon Controlled Rectifiers

For Power Switching and Control Applications

The S106 and S107 series of sensitive-gate silicon controlled rectifiers are designed for switching ac and dc currents. These SCR's are divided into the three different series according to gate sensitivity. The types within each series differ in their voltage ratings; the voltage ratings are identified by suffix letters in the type designations.

These thyristors have microampere gate-current requirements which permit operation

with low-level logic circuits. They can be used for lighting, power-switching, and motor-speed controls, and for gate-current amplification for driving larger SCR's.

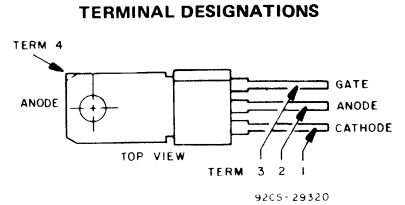
All types in each series utilize the JEDEC TO-202AB (RCA VERSATAB) plastic package.

Features:

- Microampere gate sensitivity
- 600-V capability
- 4-A (rms) on-state current ratings
- 20-A peak surge capability
- Glass-passivated chip for stability
- Low thermal resistances
- Surge capability curve

MAXIMUM RATINGS, Absolute-Maximum Values:

V_{RSXM} $R_{GK} = 1000 \Omega, T_C = -40 \text{ to } 110^\circ\text{C}$	S106Q	S106F	S106B	S106D	S106M	
V_{DSXM} $R_{GK} = 1000 \Omega, T_C = -40 \text{ to } 110^\circ\text{C}$	S107Q	S107F	S107B	S107D	S107M	
V_{RRXM} $R_{GK} = 1000 \Omega, T_C = -40 \text{ to } 110^\circ\text{C}$	25	50	75	125	250	400
V_{DRXM} $R_{GK} = 1000 \Omega, T_C = -40 \text{ to } 110^\circ\text{C}$	15	30	50	100	200	300
$I_{T(AV)}$ ($T_C = 60^\circ\text{C}, \theta = 180^\circ$)	_____ 2.5 _____ A					
$I_T(\text{RMS})$ ($T_C = 60^\circ\text{C}, \theta = 180^\circ$)	_____ 4 _____ A					
$I_T(\text{DC})$ ($T_C = 70^\circ\text{C}$)	_____ 2.75 _____ A					
I_{TSM} For one cycle of applied principal voltage, $T_C = 60^\circ\text{C}$	_____ 20 _____ A					
60 Hz (sinusoidal)	_____ 17 _____ A					
50 Hz (sinusoidal)	See Fig. 5					
For more than one cycle of applied principal voltage	_____ 0.2 _____ A					
I_{GM} ($t = 10 \mu\text{s}$)	_____ 6 _____ V					
V_{GRM} di/dt	_____ 100 _____ A/ μs					
$V_{DM} = V_{DROM}$; $I_{GT} = 1 \text{ mA}, t_r = 0.5 \mu\text{s}, T_C = 110^\circ\text{C}$	_____ 1.7 _____ A ² s					
$i^2 t$ (At T_C shown for $I_T(\text{RMS})$):	_____ 0.8 _____ A ² s					
$t = 10 \text{ ms}$	_____ 0.5 _____ W					
P_{GM} (For $10 \mu\text{s}$ max.)	_____ 0.1 _____ W					
$P_{G(AV)}$ (Averaging time = 10 ms max.)	_____ -40 to +150 _____ $^\circ\text{C}$					
T_{stg}	_____ -40 to +110 _____ $^\circ\text{C}$					
T_C	_____ 250 _____ $^\circ\text{C}$					
T_T (During soldering for 10 s max.)						



JEDEC TO-202AB

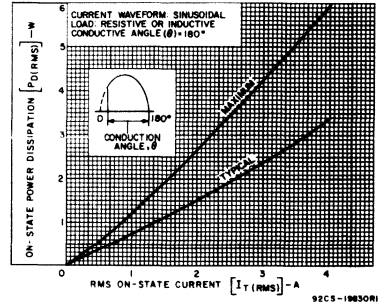


Fig. 1 - Power dissipation as a function of rms-on-state current for all series.

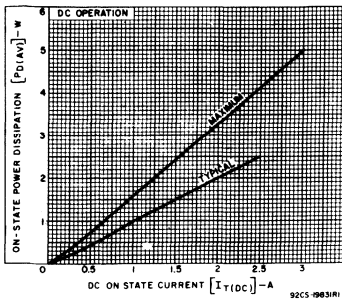


Fig. 2 - Power dissipation as a function of dc on-state current for all series.

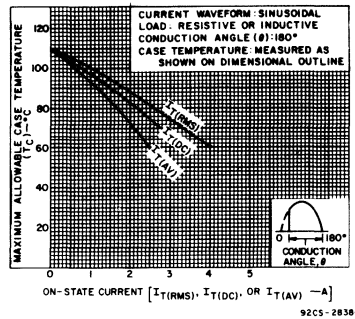


Fig. 3 - Maximum allowable case temperature as a function of on-state current for all series.

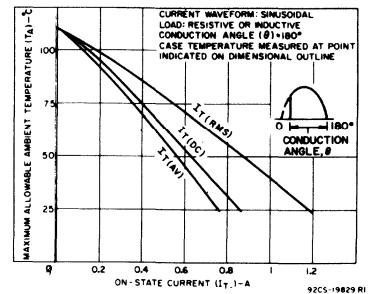


Fig. 4 - Maximum allowable ambient temperature as a function of on-state current for all series.

S106, S107 Series

ELECTRICAL CHARACTERISTICS

CHARACTERISTIC	LIMITS			UNITS
	FOR ALL TYPES UNLESS OTHERWISE SPECIFIED			
	Min.	Typ.	Max.	
I_{DRXM} or I_{RRXM} : $V_D = V_{DRXM}$ or $V_R = V_{RRXM}$, $R_{GK} = 1000 \Omega$ $T_C = 25^\circ C$ $T_C = 110^\circ C$	-	0.1 10	10 100	μA
V_T : For $i_T = 4 A$ and $T_C = 25^\circ C$ (See Fig. 9)	-	1.25	2.2	V
i_{HX} : $R_{GK} = 1000 \Omega$, $V_D = 12 V$, $I_T(\text{INITIAL}) = 50 mA$, $T_C = 25^\circ C$: S106 Series S107 Series	-	1.7 3.9	3 6	mA
i_{LX} : $R_{GK} = 1000 \Omega$, $V_D = 12 V$, $T_C = 25^\circ C$: S106 Series ($I_{GT} = 200 \mu A$) S107 Series ($I_{GT} = 500 \mu A$)	-	1.8 2.5	4 8	mA
dv/dt : $V_D = V_{DRXM}$, $R_{GK} = 1000 \Omega$, Exponential rise, $T_C = 110^\circ C$	-	8	-	V/ μs
I_{GT} : $V_D = 12 V$ dc, $R_L = 30 \Omega$, $T_C = 25^\circ C$: S106 Series S107 Series For other case temperatures	-	30	200 500	μA
V_{GT} : $V_D = 12 V$ dc, $R_L = 30 \Omega$, $T_C = 25^\circ C$ For other case temperatures	-	0.5	0.8	V
t_{gt} : $V_D = V_{DRXM}$, $i_T = 1 A$, $R_{GK} = 1000 \Omega$, $I_{GT} = 1 mA$, Rise Time = 0.1 μs , $T_C = 25^\circ C$	-	1.7	2.5	μs
t_q : $V_D = V_{DRXM}$, $i_T = 1 A$, $R_{GK} = 1000 \Omega$, Pulse Duration = 50 μs , $dv/dt = 5 V/\mu s$, $di/dt = -10 A/\mu s$, $I_{GT} = 1 mA$ at turn-on, $T_C = 110^\circ C$	-	30	100	μs
$R_{\theta JC}$	-	-	8	$^\circ C/W$
$R_{\theta JA}$	-	-	60	$^\circ C/W$

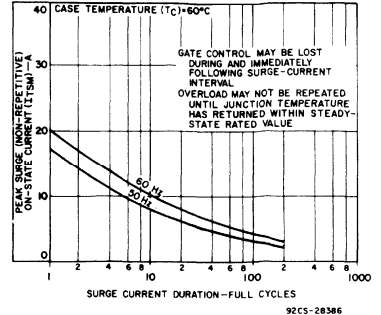


Fig. 5 - Peak surge on-state current as a function of surge-current duration for all series.

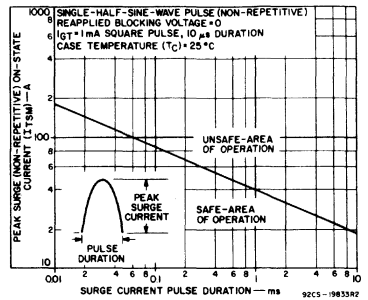


Fig. 6 - Surge capability without reapplied blocking voltage for all series.

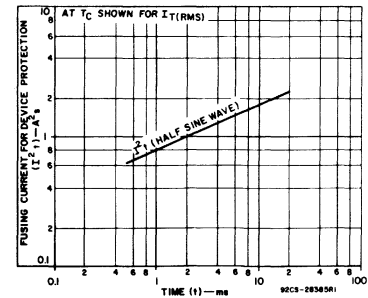


Fig. 7 - Fusing current as a function of time.

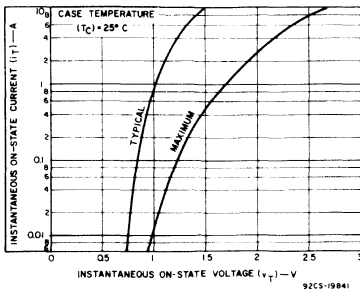


Fig. 8 - Instantaneous on-state current as a function of on-state voltage for all series.

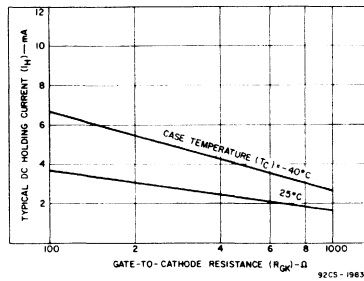


Fig. 9 - DC holding current as a function of gate-cathode resistance for the S106 series.

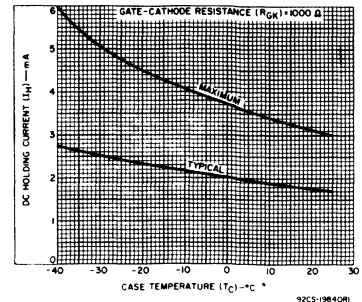


Fig. 10 - DC holding current as a function of case temperature for the S106 series.

S106, S107 Series

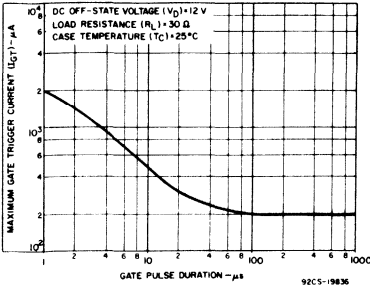


Fig. 11 - Maximum gate trigger current as a function of gate pulse duration for types in the S106 series.

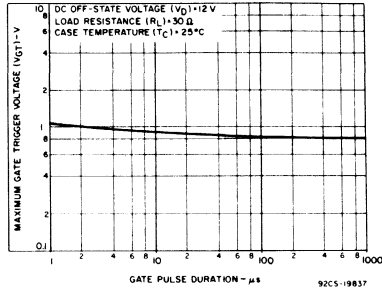


Fig. 12 - Maximum gate trigger voltage as a function of gate pulse duration for types in the S106 series.

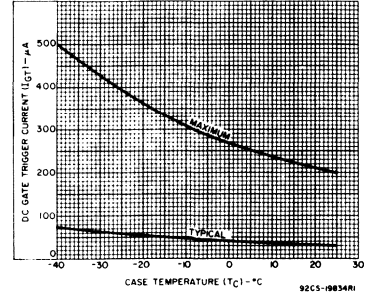


Fig. 13 - DC gate trigger current as a function of case temperature for S106 series.

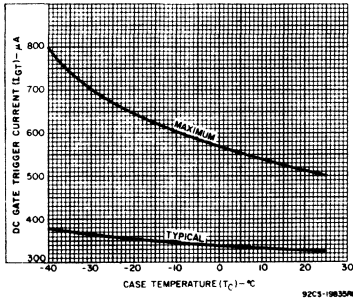


Fig. 14 - DC gate trigger current as a function of case temperature for S107 series.

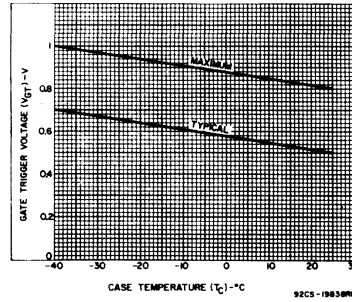


Fig. 15 - Gate trigger voltage as a function of case temperature for all series.

S2060, S2061, S2062 Series

4-A Sensitive-Gate Silicon Controlled Rectifiers

For Power Switching and Control Applications

The S2060, S2061, and S2062 series* are sensitive-gate silicon controlled rectifiers designed for switching ac and dc currents. These SCR's are divided into the three different series according to gate sensitivity. The types within each series differ in their voltage ratings; the voltage ratings are identified by suffix letters in the type designations.

These thyristors have microampere gate-current requirements which permit operation with low-level logic circuits. They

can be used for lighting, power-switching, and motor-speed controls, and for gate-current amplification for driving larger SCR's.

All types in each series utilize the JEDEC TO-220AB package. Upon request, each type is available in either of two variants of the TO-220AB package. For information on these package variations, contact the RCA Sales Office in your locale.

Features:

- Microampere gate sensitivity
- Minimum gate current specified for the S2062 series
- 600-V capability
- 4-A (rms) on-state current ratings
- 35-A peak surge capability
- Glass-passivated chip for stability
- Low thermal resistances
- Surge capability curve

* Formerly the RCA106, RCA107, and RCA108 series.

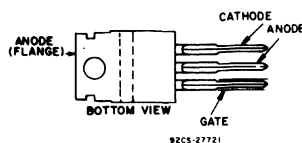
MAXIMUM RATINGS, Absolute-Maximum Values:

NON-REPETITIVE PEAK REVERSE VOLTAGE		Suffix Letter	
$R_{GK} = 1000 \Omega, T_C = -40 \text{ to } 110^\circ\text{C}$	V_{RSXM}	Q	Y
NON-REPETITIVE PEAK OFF-STATE VOLTAGE		F	A
$R_{GK} = 1000 \Omega, T_C = -40 \text{ to } 110^\circ\text{C}$	V_{DSXM}	B	C
REPETITIVE PEAK REVERSE VOLTAGE		D	E
$R_{GK} = 1000 \Omega, T_C = -40 \text{ to } 110^\circ\text{C}$	V_{RRXM}	M	
REPETITIVE PEAK OFF-STATE VOLTAGE			
$R_{GK} = 1000 \Omega, T_C = -40 \text{ to } 110^\circ\text{C}$	V_{DRXM}		
ON-STATE CURRENT:			
Conduction angle = $180^\circ, T_C = 85^\circ\text{C}$			
Average ac value	$I_{T(AV)}$	2.5	A
RMS value	$I_{T(RMS)}$	4	A
DC operation	$I_{T(DC)}$	2.75	A
PEAK SURGE (NON-REPETITIVE) ON-STATE CURRENT:			
For one cycle of applied principal voltage, $T_C = 85^\circ\text{C}$			
60 Hz (sinusoidal)	I_{TSM}	35	A
50 Hz (sinusoidal)		28	A
60 Hz (sinusoidal)		35	A
For more than one cycle of applied principal voltage			
		See Fig. 5	
PEAK GATE CURRENT ($t = 10 \mu\text{s}$)			
	I_{GM}	0.2	A
PEAK GATE REVERSE VOLTAGE			
	V_{RGM}	6	V
RATE OF CHANGE OF ON-STATE CURRENT:			
$V_{DM} = V_{DROM}, I_{GT} = 1 \text{ mA}, t_r = 0.5 \mu\text{s}, T_C = 110^\circ\text{C}$	dI/dt	100	A/ μs
FUSING CURRENT (for SCR protection):			
$T_J = -40 \text{ to } 110^\circ\text{C}, t = 1 \text{ to } 8.3 \text{ ms}$	I^2t	2.6	A ² s
GATE POWER DISSIPATION:			
PEAK FORWARD (for $10 \mu\text{s}$ max.)	P_{GM}	0.5	W
AVERAGE (averaging time = 10 ms max.)	$P_{G(AV)}$	0.1	W
TEMPERATURE RANGE:			
Storage	T_{stg}	-40 to +150	$^\circ\text{C}$
Operating (case)*	T_C	-40 to +110	$^\circ\text{C}$
TERMINAL TEMPERATURE (During soldering):			
For 10 s max.	T_T	250	$^\circ\text{C}$

* Temperature measuring point is shown in the dimensional outline.

25	50	75	125	250	400	500	600	700	V
15	30	50	100	200	300	400	500	600	V
2.5									A
4									A
2.75									A
35									A
28									A
35									A
0.2									A
6									V
100									A/ μs
2.6									A ² s
0.5									W
0.1									W
-40 to +150									$^\circ\text{C}$
-40 to +110									$^\circ\text{C}$
250									$^\circ\text{C}$

TERMINAL CONNECTIONS



JEDEC TO-220AB

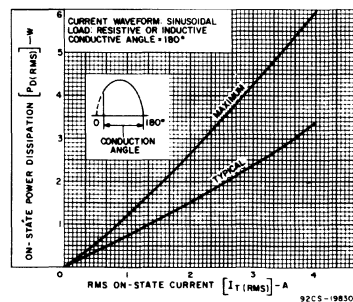


Fig. 1—Power dissipation vs. rms-on-state current for all series.

ELECTRICAL CHARACTERISTICS

CHARACTERISTIC	SYMBOL	LIMITS			UNITS
		FOR ALL TYPES UNLESS OTHERWISE SPECIFIED			
		MIN.	TYP.	MAX.	
PEAK OFF-STATE CURRENT: Forward, $V_D = V_{DRXM}, R_{GK} = 1000 \Omega$ $T_C = 25^\circ\text{C}$ $T_C = 110^\circ\text{C}$	I_{DRXM}	—	0.1	10	μA
Reverse, $V_R = V_{RRXM}, R_{GK} = 1000 \Omega$ $T_C = 25^\circ\text{C}$ $T_C = 100^\circ\text{C}$	I_{RRXM}	—	0.1	10	
INSTANTANEOUS ON-STATE VOLTAGE: For $I_T = 4 \text{ A}$ and $T_C = 25^\circ\text{C}$ (See Fig. 7)	V_T	—	1.25	2.2	V
DC GATE TRIGGER CURRENT: $V_D = 12 \text{ V (dc)}, R_L = 30 \Omega, T_C = 25^\circ\text{C}$ S2060 Series S2061 Series S2062 Series For other case temperatures	I_{GT}	—	—	200 500 2000	μA
DC GATE TRIGGER VOLTAGE: $V_D = 12 \text{ V (dc)}, R_L = 30 \Omega, T_C = 25^\circ\text{C}$ For other case temperatures	V_{GT}	—	0.5	0.8	V
INSTANTANEOUS HOLDING CURRENT: $R_{GK} = 1000 \Omega, V_D = 12 \text{ V}, I_T (\text{INITIAL}) = 50 \text{ mA}, T_C = 25^\circ\text{C}$ S2060 Series S2061 Series S2062 Series	I_H	—	1.7 3.9 6	3 6 10	mA

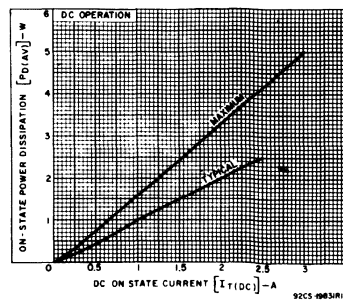


Fig. 2—Power dissipation vs. dc on-state current for all series.

S2060, S2061, S2062 Series

ELECTRICAL CHARACTERISTICS

CHARACTERISTIC	SYMBOL	LIMITS FOR ALL TYPES UNLESS OTHERWISE SPECIFIED			UNITS
		MIN.	TYP.	MAX.	
		LATCHING CURRENT: $R_{GK} = 1000 \Omega, V_D = 12 V, T_C = 25^\circ C$: S2060 Series ($I_{GT} = 200 \mu A$) S2061 Series ($I_{GT} = 500 \mu A$) S2062 Series ($I_{GT} = 2000 \mu A$)			
I_L	—	1.8	4	mA	
CRITICAL RATE OF RISE OF OFF-STATE VOLTAGE: $V_D = V_{DRXM}, R_{GK} = 1000 \Omega$, Exponential rise, $T_C = 110^\circ C$					
dv/dt	5	8	—	V/ μs	
GATE-CONTROLLED TURN-ON TIME: $V_D = V_{DRXM}, I_T = 1 A, R_{GK} = 1000 \Omega$, $I_{GT} = 1 mA$, rise time = $0.1 \mu s, T_C = 25^\circ C$					
t_{gt}	—	1.7	2.5	μs	
CIRCUIT COMMUTATED TURN-OFF TIME: $V_D = V_{DRXM}, I_T = 1 A, R_{GK} = 1000 \Omega$, Pulse Duration = $50 \mu s, dv/dt = 5 V/\mu s$, $dI/dt = -10 A/\mu s, I_{GT} = 1 mA$ at turn on, $T_C = 110^\circ C$					
t_q	—	30	100	μs	
THERMAL RESISTANCE: Junction-to-Case* Junction-to-Ambient					
$R_{\theta JC}$	—	—	3.5	$^\circ C/W$	
$R_{\theta JA}$	—	—	60		

* Temperature measuring point is shown in the dimensional outline.

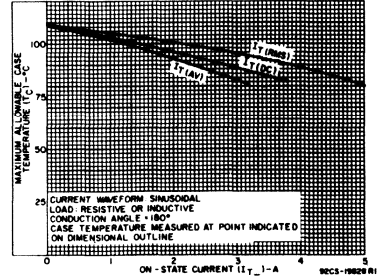


Fig. 3—Maximum allowable case temperature vs. on-state current for all series.

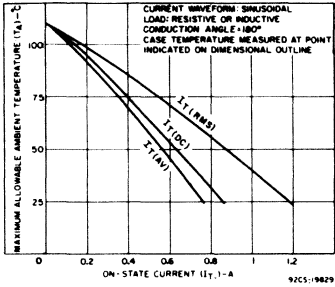


Fig. 4—Maximum allowable ambient temperature vs. on-state current for all series.

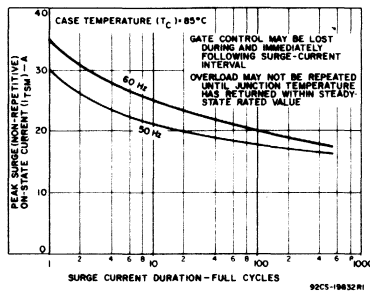


Fig. 5—Peak surge on-state current vs. surge-current duration for all series.

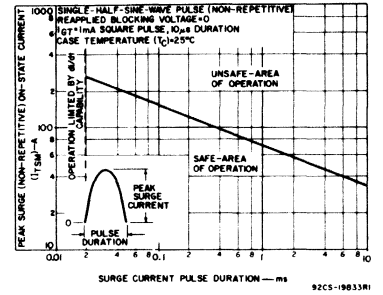


Fig. 6—Surge capability without reapplied blocking voltage for all series.

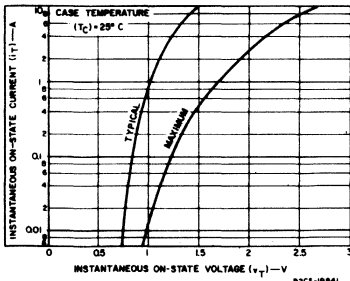


Fig. 7—Instantaneous on-state current vs. on-state voltage for all series.

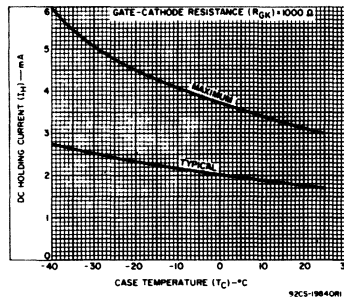


Fig. 8—DC holding current vs. case temperature for the S2060 series.

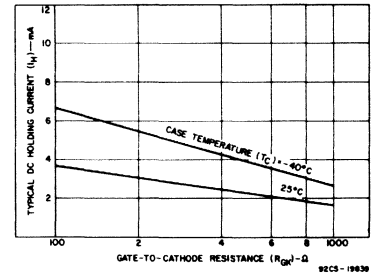


Fig. 9—DC holding current vs. gate-cathode resistance for the S2060 series.

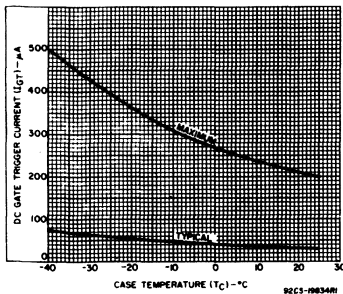


Fig. 10—DC gate-trigger current vs. case temperature for S2060 series.

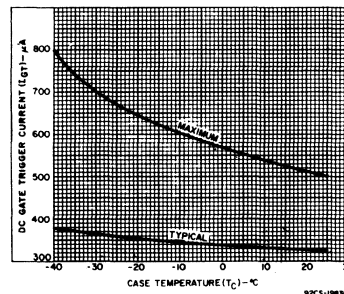


Fig. 11—DC gate-trigger current vs. case temperature for S2061 series.

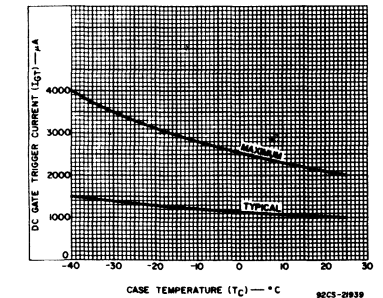


Fig. 12—DC gate-trigger current vs. case temperature for S2062 series.

S2060, S2061, S2062 Series

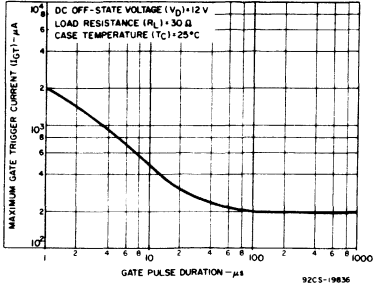


Fig. 13—Maximum gate-trigger current vs. gate-pulse duration for types in the S2060 series.

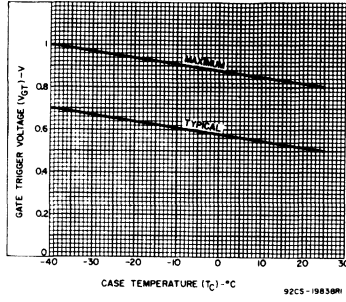


Fig. 14—Gate-trigger voltage vs. case temperature for all series.

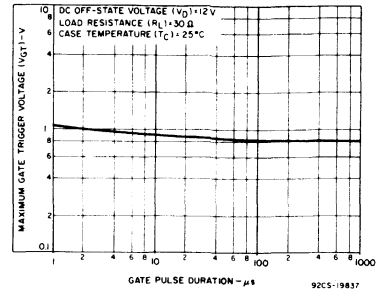


Fig. 15—Maximum gate-trigger voltage vs. gate pulse duration for types in the S2060 series.

S2200(2N3528, 2N3529, 2N4102), S2710, S2700(2N3228, 2N3525, 2N4101, Series

5-A Silicon Controlled Rectifiers

For Low-Cost Power-Control and Power-Switching Applications

RCA 2N3228*, 2N3525*, 2N4101*, and 2N3528*, 2N3529*, and 2N4102* are all-diffused, three-junction, silicon controlled-rectifiers (SCR's) intended for use in power-control and power-switching applications.

Types 2N3228, 2N3525, and 2N4101 use the JEDEC TO-66 package and have a blocking voltage capability of up to 600 volts and a forward current rating of 5 amperes (rms value) at a case temperature of 75°C.

Types 2N3528, 2N3529, and 2N4102 use the JEDEC TO-8 package and have a blocking voltage capability of up to 600 volts and a forward current rating of 2 amperes (rms value) at an ambient temperature of 25°C.

S2710B, S2710D, and S2710M are all-diffused, three-junction silicon controlled-rectifiers having integral heat radiators. They are variants of the 2N3228, 2N3525, and 2N4101, respectively.*

* Formerly Dev. Types TA1222, TA1225, and TA2773, respectively.

* Formerly Dev. Types TA2597, TA2617, and TA2774, respectively.

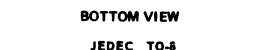
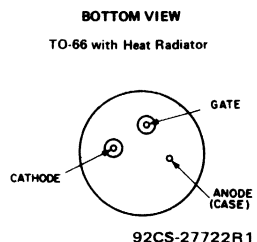
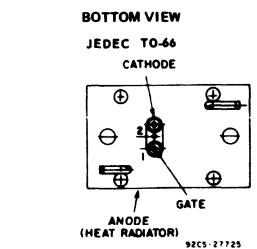
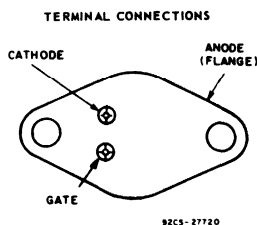
Absolute-Maximum Ratings, for Operation with Sinusoidal AC Supply Voltage at a Frequency between 50 and 400 Hz, and with Resistive or Inductive Load

RATINGS	CONTROLLED-RECTIFIER TYPES						UNITS
	2N3228 S2710B	2N3525 S2710D	2N4101 S2710M	2N3528	2N3529	2N4102	
Transient Peak Reverse Voltage (Non-Repetitive), $V_{RM}(non-rep)$	330	660	700	330	660	700	volts
Peak Reverse Voltage (Repetitive), $V_{RM}(rep)$	200	400	600	200	400	600	volts
Peak Forward Blocking Voltage (Repetitive), $V_{FBM}(rep)$	200	400	600	200	400	600	volts
Forward Current: For case temperature (T_C) of +75°C, and unit mounted on heat sink— Average DC value at a conduction angle of 180°, I_{FAV}	3.2	3.2	3.2	—	—	—	amperes
RMS value, I_{FRMS}	5.0	5.0	5.0	—	—	—	amperes
For other conditions, See Fig. 2							
For free-air temperature (T_{FA}) of 25°C, and with no heat sink employed— Average DC value at a conduction angle of 180°, I_{FAV}	1.7	1.7	1.7	1.3	1.3	1.3	amperes
RMS value, I_{FRMS}	—	—	—	2.0	2.0	2.0	amperes
For other conditions, See Figs. 3 & 4							
Peak Surge Current, $I_{FM}(surge)$: For one cycle of applied principal voltage, 60 Hz (sinusoidal), $T_C = 75^\circ C$	60			60			amperes
50 Hz (sinusoidal), $T_C = 75^\circ C$	50			50			amperes
For more than one cycle of applied voltage,	See Fig. 5			See Fig. 5			
Fusing Current (for SCR protection): $T_J = -40$ to $100^\circ C$, $t = 1$ to 8.3 ns, I^2t	15			15			ampere ² second
Rate of Change of Forward Current, di/dt	200			200			amperes/ microsecond
$V_{FB} = V_{B00}(min. value)$ $I_{GT} = 200$ mA, $0.5 \mu s$ rise time							
Gate Power*: Peak, Forward or Reverse, for $10 \mu s$ duration, P_{GM}	13			13			watts
(See Figs. 7 and 9) Average, P_{GAV}	0.5			0.5			watt
Temperature: Storage, T_{stg}	-40 to +125			-40 to +125			°C
Operating (Case), T_C	-40 to +100			-40 to +100			°C

*Any values of peak gate current or peak gate voltage to give the maximum gate power is permissible.

FEATURES

- Designed especially for high-volume systems
- Readily adaptable for printed-circuit boards and metal heat sinks
- Low switching losses
- High di/dt and dv/dt capabilities
- Shorted emitter gate-cathode construction
- Forward and reverse gate dissipation ratings
- All-diffused construction—assures exceptional uniformity and stability of characteristics
- Direct-soldered internal construction—assures exceptional resistance to fatigue
- Symmetrical gate-cathode construction—provides uniform current density, rapid electrical conduction, and efficient heat dissipation
- All-welded construction and hermetic sealing
- Low leakage currents, both forward and reverse
- Low forward voltage drop at high current levels
- Low thermal resistance



S2200(2N3528, 2N3529, 2N4102), S2710, S2700(2N3228, 2N3525, 2N4101), Series

Characteristics at Maximum Ratings (unless otherwise specified), and at Indicated Case Temperature (T_C)

CHARACTERISTICS	CONTROLLED-RECTIFIER TYPES									UNITS
	2N3228, 2N3528 S2710B			2N3525, 2N3529 S2710D			2N4101, 2N4102 S2710M			
	Min.	Typ.	Max.	Min.	Typ.	Max.	Min.	Typ.	Max.	
Forward Breakover Voltage, V_{B00} : At $T_C = +100^\circ\text{C}$	200	—	—	400	—	—	600	—	—	volts
Peak Blocking Current, at $T_C = +100^\circ\text{C}$:										
Forward, I_{FB0M}	—	0.10	1.5	—	0.20	3.0	—	0.40	4.0	mA
$V_{FB0} = V_{B00}$ (min. value)										
Reverse, I_{RB0M}	—	0.05	0.75	—	0.10	1.5	—	0.20	2.0	mA
$V_{RBO} = V_{RM}$ (rep. value)										
Forward Voltage Drop, V_F At a Forward Current of 30 amperes and a $T_C = +25^\circ\text{C}$	—	2.15	2.8	—	2.15	2.8	—	2.15	2.8	volts
DC Gate-Trigger Current, I_{GT} At $T_C = +25^\circ\text{C}$ (See Fig. 9)	—	8	15	—	8	15	—	8	15	mA (dc)
Gate-Trigger Voltage, V_{GT} At $T_C = +25^\circ\text{C}$ (See Fig. 9)	—	1.2	2.0	—	1.2	2.0	—	1.2	2.0	volts (dc)
Holding Current, I_{HQ} At $T_C = +25^\circ\text{C}$	—	10	20	—	10	20	—	10	20	mA
Critical Rate of Applied Forward Voltage, Critical dv/dt	10	200	—	10	200	—	10	200	—	volts/ microsecond
$V_{FB} = V_{B00}$ (min. value), exponential rise, $T_C = +100^\circ\text{C}$										
Turn-On Time, t_{on} , (Delay Time + Rise Time) $i_F = 2$ amperes, $50 \mu\text{s}$ pulse width, $dv_{FB}/dt = 20 \text{V}/\mu\text{s}$, $dI_T/dt = 30 \text{A}/\mu\text{s}$, $I_{GT} = 200 \text{mA}$, $T_C = +25^\circ\text{C}$	0.75	1.5	—	0.75	1.5	—	0.75	1.5	—	microseconds
Turn-Off Time, t_{off} $i_F = 2$ amperes, $50 \mu\text{s}$ pulse width, $dv_{FB}/dt = 20 \text{V}/\mu\text{s}$, $dI_T/dt = 30 \text{A}/\mu\text{s}$, $I_{GT} = 200 \text{mA}$, $T_C = +75^\circ\text{C}$	—	15	50	—	15	50	—	15	50	microseconds
Thermal Resistance:										
Junction-to-case	—	—	4	—	—	—	—	—	5	$^\circ\text{C}/\text{W}$
Junction-to-ambient	—	—	40	—	—	—	—	—	40	$^\circ\text{C}/\text{W}$
Junction-to-Ambient	S2710 series									$^\circ\text{C}/\text{W}$
	—	—	28	—	—	—	—	—	—	

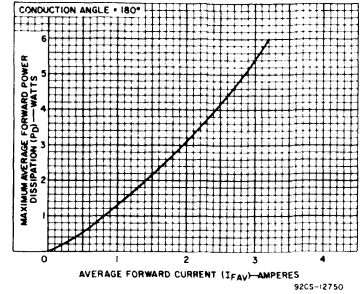


Fig. 1—Power dissipation chart for all types.

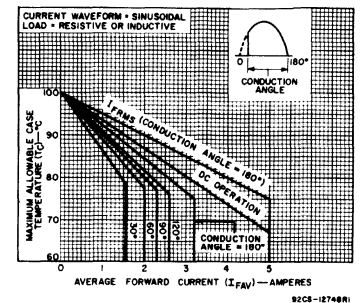


Fig. 2—Rating chart (case temperature) for types 2N3228, 2N3525, and 2N4101.

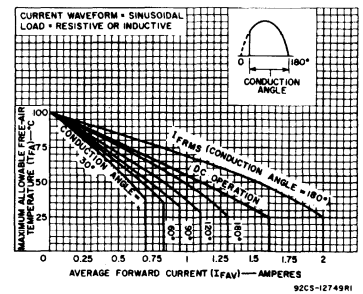


Fig. 3—Rating chart (free-air temperature) for types 2N3528, 2N3529, and 2N4102.

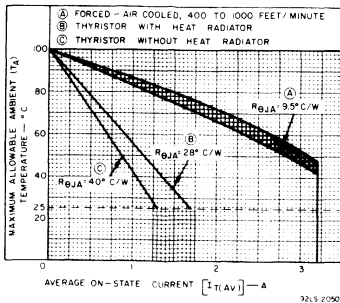


Fig. 4—Maximum allowable ambient temperature vs. on-state current for S2710 series only.

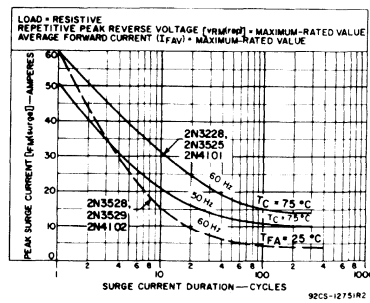


Fig. 5—Surge-current rating chart.

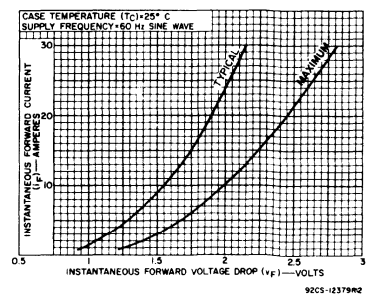


Fig. 6—Forward characteristics for all types.

S2200(2N3528, 2N3529, 2N4102), S2710, S2700(2N3228, 2N3525, 2N4101), Series

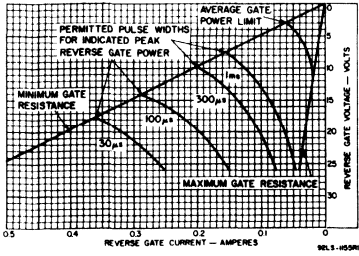


Fig. 7 - Reverse gate characteristics.

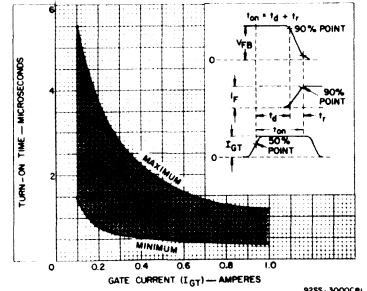


Fig. 8 - Turn-on time characteristics.

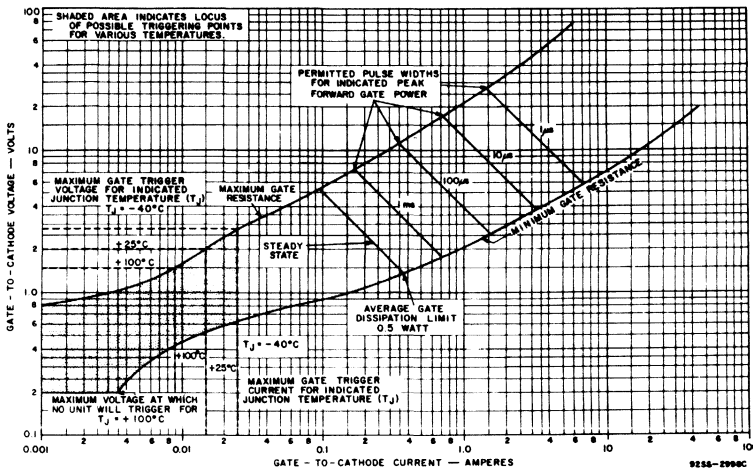


Fig. 9 - Forward gate characteristics.

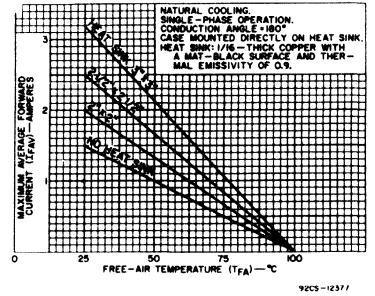


Fig. 10 - Operation guidance chart for types 2N3228, 2N3525, and 2N4101.

S2600, S2610, S2620 Series

7-A "Low-Profile" Silicon Controlled Rectifiers

For Power Switching, Power Control, Power Crowbar, and Ignition Applications

The S2600, S2610, and S2620 series are all-diffused, silicon controlled rectifiers (reverse-blocking triode thyristors) for capacitor-discharge ignition systems, high-voltage generators, and power-switching and control applications. They may be used in capacitor-discharge ignition systems (battery or magneto types) for internal combustion engines, electronic igniters, and high-voltage generators. Other uses are power-control and power-switching circuits.

The S2600B, S2600D, and S2600M have a three-lead low-profile package (similar to the JEDEC TO-5). The S2610B, S2610D, and S2610M have integral heat radiators. The S2620B, S2620D, and S2620M have integral heat spreaders.

MAXIMUM RATINGS, Absolute-Maximum Values:

For Operation with Sinusoidal Supply Voltage at Frequencies up to 50/60 Hz and with Resistive or Inductive Load.

	S2600B S2610B S2620B	S2600D S2610D S2620D	S2600M S2610M S2620M		
NON-REPETITIVE PEAK REVERSE VOLTAGE* Gate open	V _{RSOM}	250	500	700	V
NON-REPETITIVE PEAK OFF-STATE VOLTAGE* Gate open	V _{D SOM}	250	500	700	V
REPETITIVE PEAK REVERSE VOLTAGE* Gate open	V _{RR OM}	200	400	600	V
REPETITIVE PEAK OFF-STATE VOLTAGE* Gate open	V _{D ROM}	200	400	600	V
RMS ON-STATE CURRENT (Conduction angle = 180°)	I _{T (RMS)}	See Fig. 2-6			
PEAK SURGE (NON-REPETITIVE) ON-STATE CURRENT For one cycle of applied principal voltage	I _{T SM}	100	100	100	A
60 Hz (sinusoidal)		85	85	85	A
50 Hz (sinusoidal)		See Fig. 7			
For more than one cycle of applied principal voltage					
PEAK REPETITIVE ON-STATE CURRENT† (See Fig. 16): Duty factor = 0.1%, T _C = 75°C Pulse duration = 5 μs (min.), 20 μs (max.)	I _{TRM}	100	100	100	A
RATE OF CHANGE OF ON-STATE CURRENT: V _{DM} = V _{D ROM} , I _{GT} = 200 mA, t _r = 0.5 μs	di/dt	200			A/μs
FUSING CURRENT (for SCR protection): T _J = -65 to 100°C, t = 1 to 8.3 ms	I ² t	40			A ² s
NON-REPETITIVE SUB-CYCLE SURGE CURRENT: T _C = 25°C, single pulse, I _{GT} = 50 mA, 10 μs square pulse		See Fig. 20			
GATE POWER DISSIPATION ^a :					
PEAK FORWARD (for 1 μs max.)	P _{GM}	40	40	40	W
PEAK REVERSE	P _{PRM}	See Fig. 14			
AVERAGE (averaging time = 10 ms, max.)	P _{G(AV)}	0.5	0.5	0.5	W
TEMPERATURE RANGE ^b :					
Storage	T _{stg}	-65 to +150			°C
Operating (case)	T _C	-65 to +100			°C
LEAD TEMPERATURE (During soldering) ^c : For 10 s max. for case or leads		225			°C

† When rms current exceeds 4 amperes (maximum rating for the anode lead), connection must be made to the case.

^a These values do not apply if there is a positive gate signal. Gate must be open, terminated, or have negative bias.

^b Any values of peak gate current or peak gate voltage that yield the maximum gate power are permissible.

^c For information on the reference point of temperature measurement, see dimensional outlines.

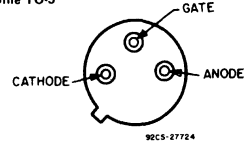
^d When these devices are soldered directly to the heat sink, a 60/40 solder should be used. Case heating time should be a minimum... sufficient to allow the solder to flow freely.

Features:

- Forward and reverse gate ratings
- All-diffused center gate construction
- Low leakage currents, both forward and reverse
- Low forward voltage drop at high current levels
- High pulse-current capability for capacitor-discharge ignition circuits
- High dv/dt capability
- Low switching losses
- Low thermal resistance
- Sub-cycle surge capability curve

TERMINAL CONNECTIONS

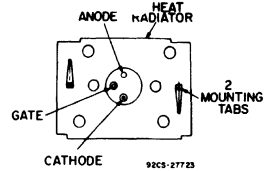
"Low-Profile TO-5"



92CS-27724

BOTTOM VIEW
S2600 Series

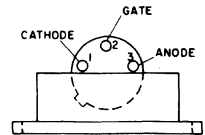
"Low-Profile TO-5" with Heat Radiator



92CS-27723

BOTTOM VIEW
S2610 Series

"Low-Profile TO-5" with Heat Spreader



92CS-27734

S2620 Series

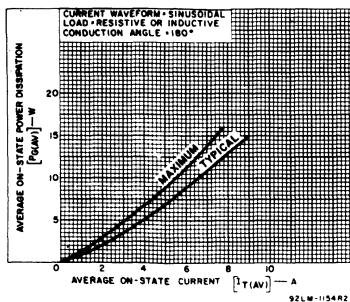


Fig. 1—Power dissipation vs. on-state current.

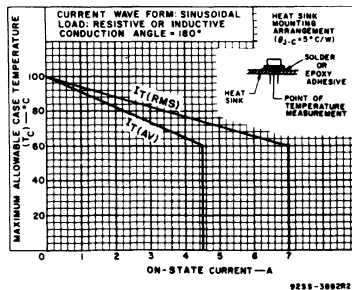


Fig. 2—Maximum allowable case temperature vs. on-state current for S2600 series.

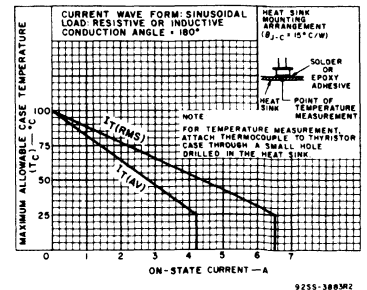


Fig. 3—Maximum allowable case temperature vs. on-state current for S2600 series.

S2600, S2610, S2620 Series

ELECTRICAL CHARACTERISTICS, At maximum ratings and at indicated case temperature (T_C) unless otherwise specified

CHARACTERISTIC	SYMBOL	LIMITS						UNITS
		S2600 Series			S2610 Series S2620 Series			
		MIN.	TYP.	MAX.	MIN.	TYP.	MAX.	
PEAK OFF-STATE CURRENT: (Gate Open, T _C = +100°C) FORWARD, V _D = V _{DROM}	I _{DOM}	-	0.1	0.5	-	0.2	1.5	mA
REVERSE, V _R = V _{RROM}	I _{ROM}	-	0.05	0.5	-	0.1	1.5	mA
INSTANTANEOUS ON-STATE VOLTAGE: For i _T = 30 A and T _C = +25°C	V _T	-	1.9	2.6	-	1.9	2.6	V
DC GATE TRIGGER CURRENT: V _D = 12 V (DC) R _L = 30 Ω T _C = +25°C For other case temperatures	I _{GT}	-	6	15	-	6	15	mA
DC GATE TRIGGER VOLTAGE: V _D = 12 V (DC) R _L = 30 Ω T _C = +25°C For other case temperatures	V _{GT}	-	0.65	1.5	-	0.65	1.5	V
INSTANTANEOUS HOLDING CURRENT: Gate Open and T _C = +25°C For other case temperatures	I _{HO}	-	9	20	-	9	20	mA
CRITICAL RATE-OF-RISE OF OFF-STATE VOLTAGE: V _D = V _{DROM} Exponential rise, T _C = +100°C (See Fig. 3)	dv/dt	20	200	-	20	200	-	V/μs
GATE CONTROLLED TURN-ON TIME: V _D = V _{DROM} , i _T = 4.5 A I _{GT} = 200 mA, 0.1 μs rise time T _C = +25°C (See Fig. 15)	t _{gt}	-	1	2	1	2	-	μs
CIRCUIT COMMUTATED TURN-OFF TIME: V _D = V _{DROM} , i _T = 2 A Pulse Duration = 50 μs dv/dt = 20V/μs, di/dt = -30A/μs I _{GT} = 200 mA at turn on, T _C = +75°C	t _q	-	15	50	-	15	50	μs
THERMAL RESISTANCE: Junction-to-Case	R _{θJC}	-	-	5	-	-	5	°C/W
Junction-to-Ambient (See dimensional outlines)	R _{θJA}	-	-	120	-	-	30 (S2610 Series)	
Junction-to-Heat Spreader (See dimensional outline)	R _{θJHS}	-	-	-	-	-	7 (S2620 Series)	

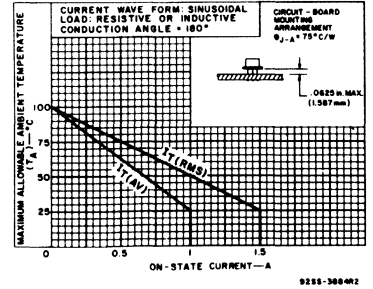


Fig. 4—Maximum allowable ambient temperature vs. on-state current for S2600 series.

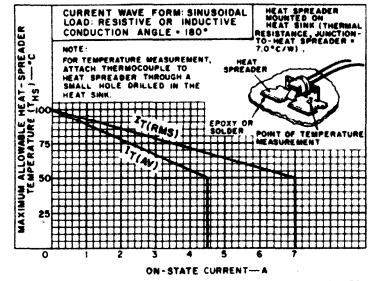


Fig. 5—Maximum allowable heat-spreader temperature vs. on-state current for S2620 series.

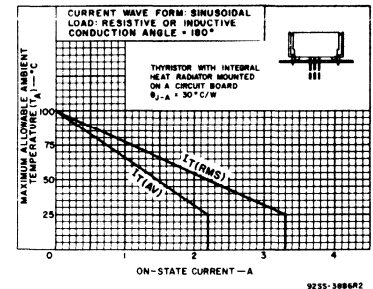


Fig. 6—Maximum allowable ambient temperature vs. on-state current for S2610 series.

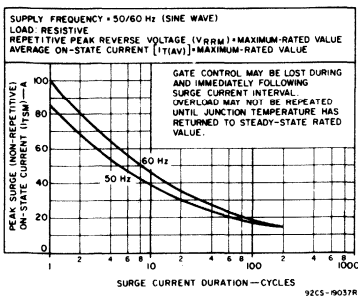


Fig. 7—Peak surge on-state current vs. surge-current duration for all types.

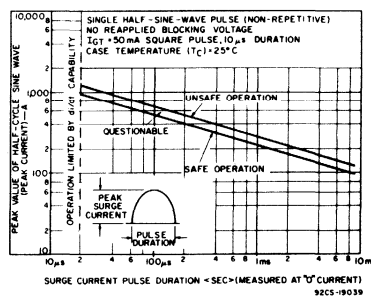


Fig. 8—Sub-cycle surge capability.

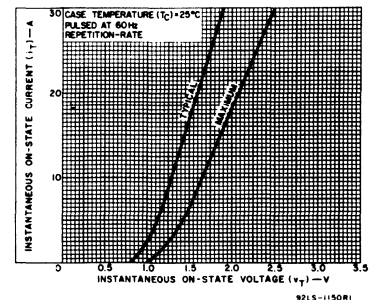


Fig. 9—Instantaneous on-state current vs. on-state voltage for all types.

S2600, S2610, S2620 Series

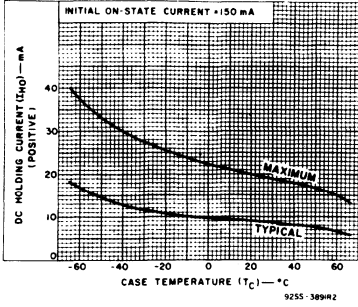


Fig. 10—DC holding current (positive) vs. case temperature.

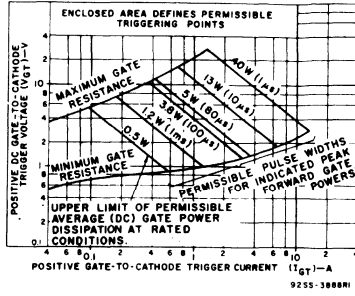


Fig. 11—Gate-pulse characteristics for forward-triggering mode.

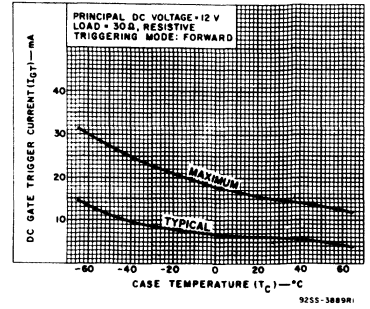


Fig. 12—DC gate-trigger current (forward) vs. case temperature.

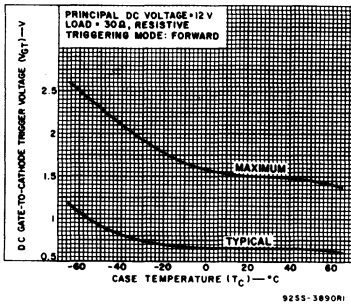


Fig. 13—DC gate-trigger voltage vs. case temperature.

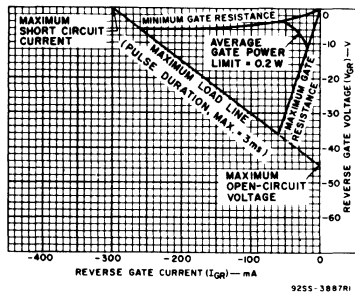


Fig. 14—Reverse-gate voltage vs. reverse-gate current.

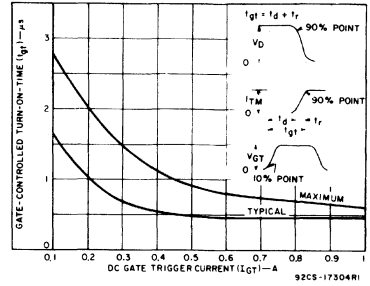


Fig. 15—Gate controlled turn-on time (t_{gt}) vs. gate-trigger current.

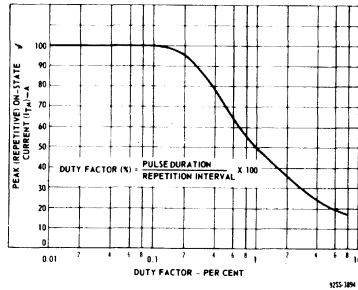


Fig. 16—Derating curve for peak pulse current (repetitive) vs. duty factor for the ignition circuit.

S2800, S122 Series

8-A and 10-A Silicon Controlled Rectifiers

For Power Switching, Power Control, and Ignition Applications

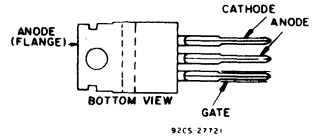
The RCA-S122 and RCA-S2800 series types are medium-power silicon controlled rectifiers (reverse-blocking triode thyristors) designed for switching ac and dc currents. These devices can switch from the off-state to the on-state when both the anode and gate voltages are positive. Negative anode voltages make these devices revert to the blocking state regardless of gate-voltage polarity.

The plastic TO-220AB package provides easy package mounting and low thermal resistance, allowing operation at high case temperatures and permitting reduced heat-sink size. These SCR's can be used in lighting and motor-speed controls, capacitor-discharge ignition circuits, high-voltage generators, automotive applications, and power-switching systems.

Features:

- High dv/dt capability
- Glass-passivated chip
- Low on-state voltage at high current levels
- Shorted-emitter gate-cathode construction
- Low thermal resistance
- Center-gate construction

TERMINAL CONNECTIONS



MAXIMUM RATINGS, Absolute-Maximum Values:

	S122F S2800F	S122A S2800A	S122B S2800B	S122C S2800C	S122D S2800D	S122E S2800E	S122M S2800M	S122S S2800S	
$V_{RSM} \Delta V_{DSOM} \Delta$	75	125	250	375	500	600	700	800	V
$V_{RROM} \Delta V_{DROM} \Delta$	50	100	200	300	400	500	600	700	V
$I_{T(RMS)}$ ($T_C = 75^\circ\text{C}$)									A
$\theta = 180^\circ$ - S122 series					8				A
S2800 series					10				A
I_{TSM}									A
For one full cycle of applied principal voltage 400 Hz					200				A
60 Hz					100				A
50 Hz					85				A
For more than one full cycle of applied principal voltage					See Fig. 4				A
di/dt									A/ μs
$V_D = V_{DROM}$ $I_{GT} = 80 \text{ mA}, t_r = 0.5 \mu\text{s}$					100				A/ μs
I_{T^2}									A ² s
$T_J = -65$ to 100°C ; $t = 1$ to 8.3 ms					40				A ² s
F_{GM} Δ or $10 \mu\text{s max.}$					15				W
$P_{G(AV)}$					See Fig. 10				W
$P_{G(AV)}$ Δ (averaging time = 10 ms max.)					0.5				W
T_{stg}					-65 to +150				$^\circ\text{C}$
T_C					-65 to +100				$^\circ\text{C}$
T_T									$^\circ\text{C}$
During soldering for 10 s maximum (terminal and case).					250				$^\circ\text{C}$

- ▲ These values do not apply if there is a positive gate signal. Gate must be open or negatively biased.
- ▲ Any values of peak gate current or peak gate voltage which result in an equal or lower power are permissible.
- For information on the reference point of temperature measurement, see Dimensional Outline.

ELECTRICAL CHARACTERISTICS

At Maximum Ratings Unless Otherwise Specified and at Indicated Case Temperature (T_C)

CHARACTERISTIC	LIMITS			UNITS
	For All Types Except as Specified			
	MIN.	TYP.	MAX.	
I_{DOM} or I_{ROM} $V_D = V_{DROM}$ or $V_R = V_{RROM}$, $T_C = +100^\circ\text{C}$	-	0.1	2	mA
V_T $i_T = 16 \text{ A}, T_C = 25^\circ\text{C}$ (S122 series) $= 30 \text{ A}, T_C = 25^\circ\text{C}$ (S2800 series)	-	1.45	1.83	V
I_{GT} $V_D = 12 \text{ V (dc)}, R_L = 30 \Omega, T_C = 25^\circ\text{C}$ (S122 series) $V_D = 12 \text{ V (dc)}, R_L = 30 \Omega, T_C = 25^\circ\text{C}$ (S2800 series)	-	18	25	mA
V_{GT} $V_D = 12 \text{ V (dc)}, R_L = 30 \Omega, T_C = 25^\circ\text{C}$ For other case temperatures	-	0.9	1.5	V
i_{HO} $T_C = 25^\circ\text{C}$ (S122 series) $T_C = 25^\circ\text{C}$ (S2800 series) For other case temperatures	-	20	30	mA

JEDEC TO-220AB

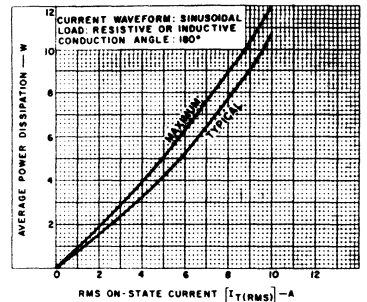


Fig. 1 - Power dissipation vs. on-state current for all types.

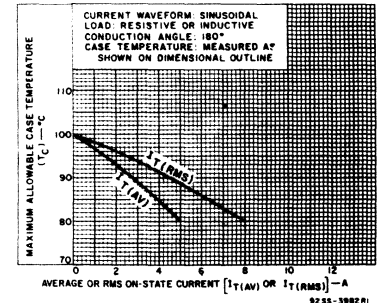


Fig. 2 - Maximum allowable case temperature vs. on-state current for S122 series.

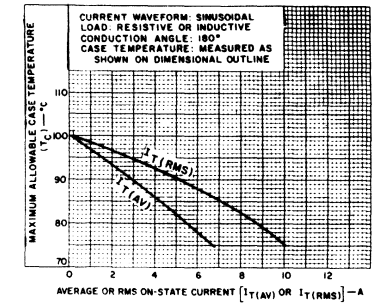


Fig. 3 - Maximum allowable case temperature vs. on-state current for S2800 series.

S2800, S122 Series

ELECTRICAL CHARACTERISTICS.

At Maximum Ratings Unless Otherwise Specified and at Indicated Case Temperature (T_C)

CHARACTERISTIC	LIMITS			UNITS
	For All Types Except as Specified			
	MIN.	TYP.	MAX.	
dv/dt $V_D = V_{DROM}$ Exponential voltage rise, $T_C = 100^\circ C$	10	100	—	V/ μs
S122 series	100	—	—	
S2800F	75	—	—	
S2800A	50	—	—	
S2800B	40	—	—	
S2800C	30	—	—	
S2800D	25	—	—	
S2800E	20	—	—	
S2800M	15	—	—	—
S2800S	—	—	—	—
t_{gt} $V_D = V_{DROM}$, $i_T = 4.5 A$, $i_T = 2 A$ $I_{GT} = 80 mA$, $0.1 \mu s$ rise time $T_C = +25^\circ C$	—	1.6	2.5	μs
t_q $V_D = V_{DROM}$, $i_T = 2 A$, $t_p = 50 \mu s$ $dv/dt = 200 V/\mu s$, $di/dt = -10 A/\mu s$ $I_{GT} = 200 mA$ at t_{ON} , $T_C = +75^\circ C$	—	10	35	μs
$R_{\theta JC}$	—	—	2	$^\circ C/W$
$R_{\theta JA}$	—	—	60	$^\circ C/W$

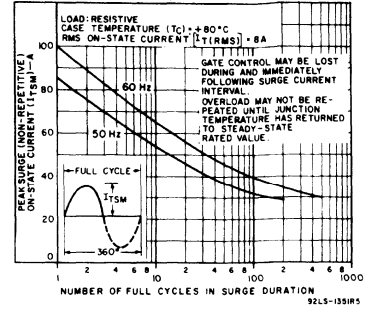


Fig. 4 — Allowable peak surge on-state current vs. surge duration for all types.

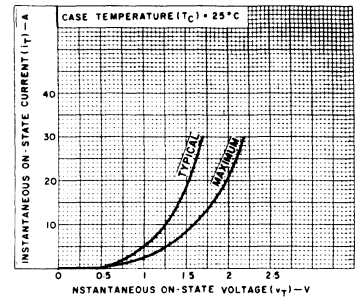


Fig. 5 — Instantaneous on-state current vs. on-state voltage for S122 series.

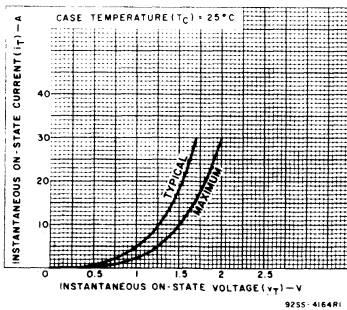


Fig. 6 — Instantaneous on-state current vs. on-state voltage for S2800 series.

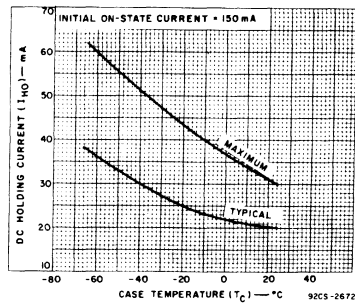


Fig. 7 — Holding current vs. case temperature for S122 series.

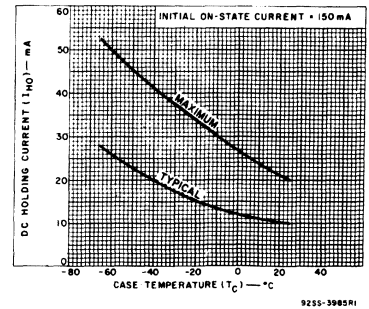


Fig. 8 — Holding current vs. case temperature for S2800 series.

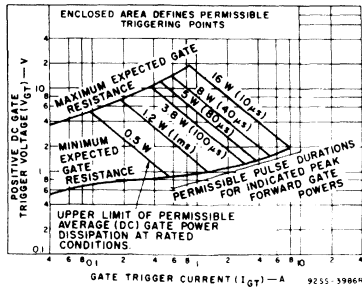


Fig. 9 — Typical forward-biased gate characteristics for all types.

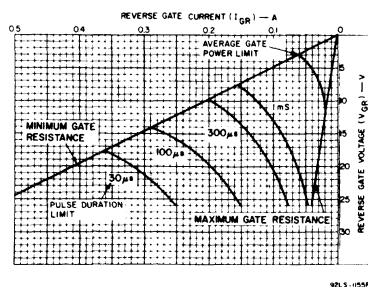


Fig. 10 — Reverse gate voltage vs. reverse gate current for all types.

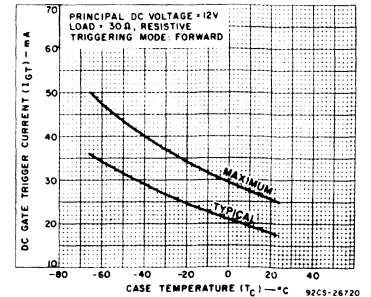


Fig. 11 — DC gate-trigger current vs. case temperature for S122 series.

S2800, S122 Series

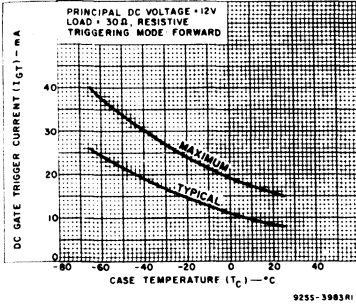


Fig. 12 - DC gate-trigger current vs. case temperature for S2800 series.

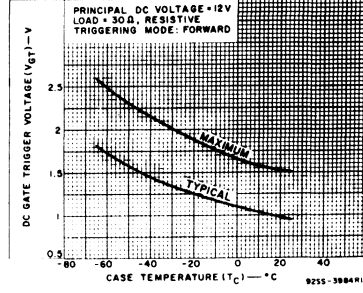


Fig. 13 - DC gate-trigger voltage vs. case temperature for all types.

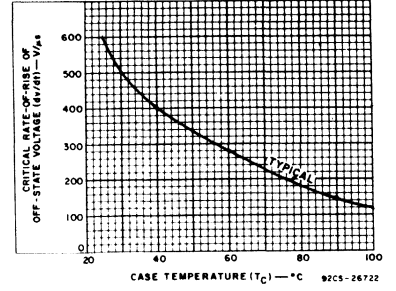


Fig. 14 - Critical rate-of-rise of off-state voltage vs. case temperature for S122 series.

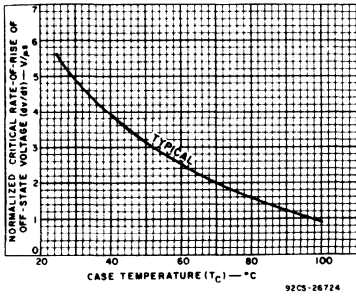


Fig. 15 - Normalized critical rate of rise of off-state voltage vs. case temperature for S2800 series.

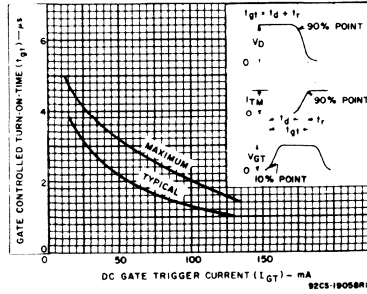


Fig. 16 - Gate-controlled turn-on time vs. gate trigger current for all types.

S3700, S3704, S3714 Series

5-A Silicon Controlled Rectifiers

For Inverter Applications

The RCA-S3700, S3704, and S3714-series types are all diffused, silicon controlled rectifiers (reverse-blocking triode thyristors) designed for inverter applications such as ultrasonics, choppers, regulated power supplies, induction heaters, cycloconverters,

and fluorescent lighting. These types may be used at frequencies up to 25 kHz.

The S3700 and S3704 series employ a hermetic JEDEC TO-66 package. The S3714 series employs a TO-66 with heat radiator package.

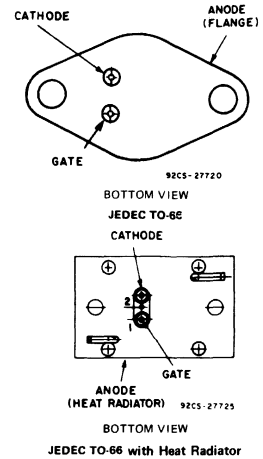
MAXIMUM RATINGS, Absolute-Maximum Values:	SYMBOL	S3700B S3700D S3700M					
		S3704A S3714A	S3704B S3714B	S3704D S3714D	S3704M S3714M	S3704S S3714S	
NON-REPETITIVE PEAK REVERSE VOLTAGE [Ⓜ]	V_{RSOM}	150	300	500	700	800	V
NON-REPETITIVE PEAK OFF-STATE VOLTAGE [Ⓜ]	V_{DSOM}	150	300	500	700	800	V
REPETITIVE PEAK REVERSE VOLTAGE [Ⓜ]	V_{RROM}	100	200	400	600	700	V
REPETITIVE PEAK OFF-STATE VOLTAGE [Ⓜ]	V_{DROM}	100	200	400	600	700	V
ON-STATE CURRENT: $T_C = 60^\circ\text{C}$, conduction angle = 180° :							
RMS	$I_{T(RMS)}$	5					A
Average	$I_{T(AV)}$	3.2					A
For other conditions		See Figs. 3, 4					
PEAK SURGE (NON-REPETITIVE) ON-STATE CURRENT: For one full cycle of applied principal voltage, $T_C = 60^\circ\text{C}$	I_{TSM}						
60 Hz (sinusoidal)		80	80	80	80	80	A
50 Hz (sinusoidal)		65	65	65	65	65	A
For more than one full cycle of applied principal voltage		See Fig. 5					
RATE OF CHANGE OF ON-STATE CURRENT	di/dt	200					A/ μs
$V_D = V_{DROM}$, $I_{GT} = 50\text{ mA}$, $t_r = 0.1\ \mu\text{s}$							
FUSING CURRENT (for SCR protection): $T_J = -40$ to 100°C , $t = 1$ to 8.3 ms	i^2t	25					A
GATE POWER DISSIPATION [Ⓜ]							
Peak Forward (for $10\ \mu\text{s}$ max., See Fig. 7)	P_{GM}	13					W
Peak Reverse (for $10\ \mu\text{s}$ max., See Fig. 8)	P_{RGM}	13					W
Average (averaging time = 10 ms max.)	$P_{G(AV)}$	0.5					W
TEMPERATURE RANGE [Ⓜ]							
Storage	T_{stg}	-40 to 150					$^\circ\text{C}$
Operating (Case)	T_C	-40 to 100					$^\circ\text{C}$
PIN TEMPERATURE (During soldering): At distances $\geq 1/32$ in. (0.8 mm) from seating plane for 10 s max.	T_p	225					$^\circ\text{C}$

Ⓜ These values do not apply if there is a positive gate signal. Gate must be open or negatively biased.
 Ⓜ Any product of gate current and gate voltage which results in a gate power less than the maximum is permitted.
 Ⓜ For temperature measurement reference point, see Dimensional Outline.

Features

- Fast turn-off time- $8\ \mu\text{s}$ max.
- High di/dt and dv/dt capabilities
- Shorted-emitter gate-cathode construction...contains an internally diffused resistor between gate and cathode
- Center gate construction...provides rapid uniform gate-current spreading for faster turn-on with substantially reduced heating effects

TERMINAL CONNECTIONS



ELECTRICAL CHARACTERISTICS

At Maximum Ratings Unless Otherwise Specified and at Indicated Case Temperature (T_C)

CHARACTERISTIC	SYMBOL	LIMITS			UNITS
		FOR ALL TYPES Except as Specified			
		MIN.	TYP.	MAX.	
Peak Off-State Current: (Gate open, $T_C = 100^\circ\text{C}$)					
Forward Current (I_{DOM}) at $V_D = V_{DROM}$	I_{DOM}	-	0.5	3	mA
Reverse Current (I_{ROM}) at $V_R = V_{RROM}$	I_{ROM}	-	0.3	1.5	mA
Instantaneous On-State Voltage: $i_T = 30\text{ A}$ (peak), $T_C = 25^\circ\text{C}$	v_T	-	2.2	3	V
For other conditions				See Fig. 6	
Instantaneous Holding Current: Gate open, $T_C = 25^\circ\text{C}$	i_{HO}	-	20	50	mA
Critical Rate of Rise of Off-State Voltage: $V_D = V_{DROM}$, exponential voltage rise, Gate open, $T_C = 80^\circ\text{C}$	dv/dt	100	250	-	V/ μs
DC Gate Trigger Current: $V_D = 12\text{ V}$ (dc), $R_L = 30\ \Omega$, $T_C = 25^\circ\text{C}$	I_{GT}	-	15	40	mA
For other conditions				See Fig. 7	
DC Gate Trigger Voltage: $V_D = 12\text{ V}$ (dc), $R_L = 30\ \Omega$, $T_C = 25^\circ\text{C}$	V_{GT}	-	1.8	3.5	V
For other conditions				See Fig. 7	
Gate Controlled Turn-On Time: (Delay Time + Rise Time) For $V_{DX} = V_{DROM}$, $I_{GT} = 300\text{ mA}$, $t_r = 0.1\ \mu\text{s}$, $I_T = 2\text{ A}$ (peak), $T_C = 25^\circ\text{C}$ (See Fig. 10)	t_{gt}	-	0.7	-	μs
Circuit Commutated Turn-Off Time: $V_{DX} = V_{DROM}$, $i_T = 2\text{ A}$, pulse duration = $50\ \mu\text{s}$, $dv/dt = 100\text{ V}/\mu\text{s}$, $-di/dt = -10\text{ A}/\mu\text{s}$, $I_{GT} = 100\text{ mA}$, $V_{GT} = 0\text{ V}$ (at turn-off), $T_C = 80^\circ\text{C}$ (See Fig. 13)	t_q	-	4	6	μs
S3700 series		-	4	6	
S3704, S3714 series		-	4	8	
Thermal Resistance:					
Junction-to-Case	$R_{\theta JC}$	-	4	8	$^\circ\text{C}/\text{W}$
Junction-to-Ambient	$R_{\theta JA}$	-	-	40	$^\circ\text{C}/\text{W}$

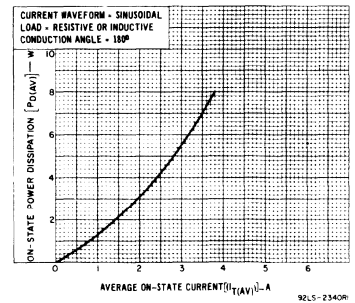


Fig. 1—Power dissipation vs. average on-state current.

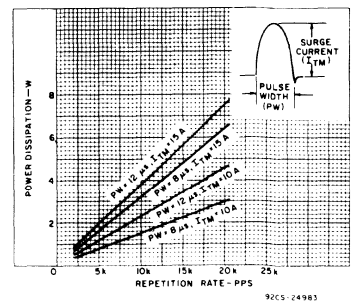


Fig. 2—Dissipation vs. repetition rate.

S3700, S3704, S3714 Series

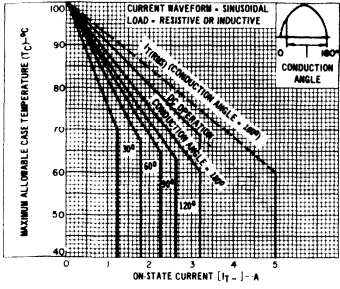


Fig. 3—Maximum allowable case temperature vs. on-state current.

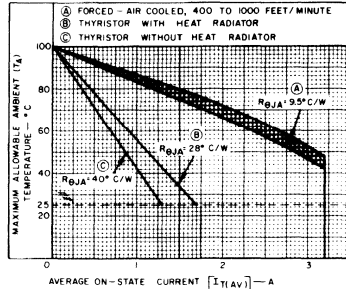


Fig. 4—Maximum allowable ambient temperature vs. average on-state current.

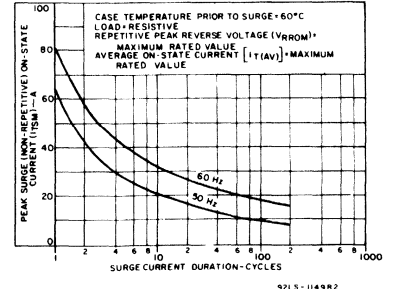


Fig. 5—Peak surge on-state current vs. surge-current duration.

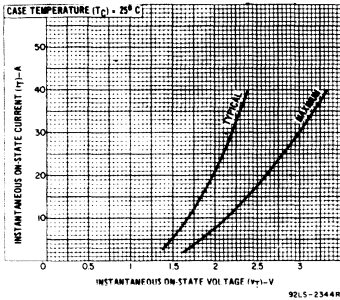


Fig. 6—Instantaneous on-state current vs. on-state voltage.

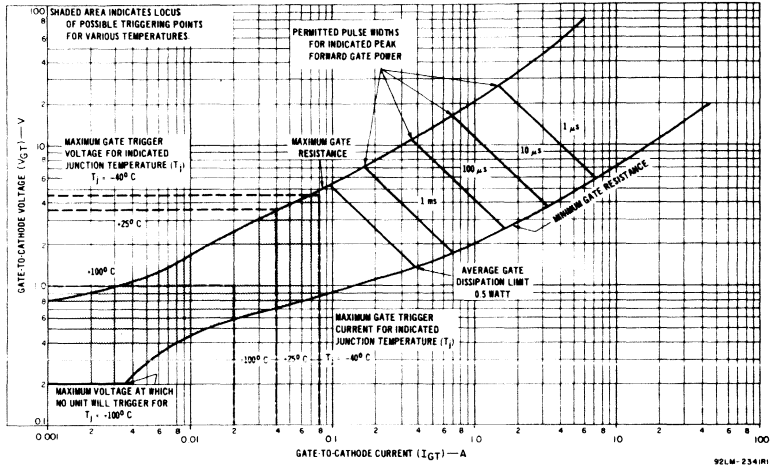


Fig. 7—Gate-trigger characteristics and limiting conditions for determination of permissible gate-trigger pulses.

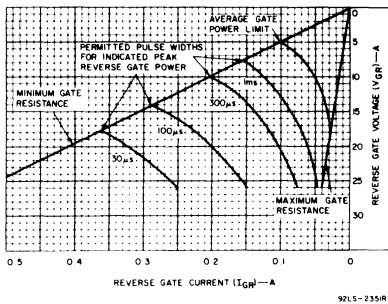


Fig. 8—Reverse-gate voltage vs. reverse-gate current.

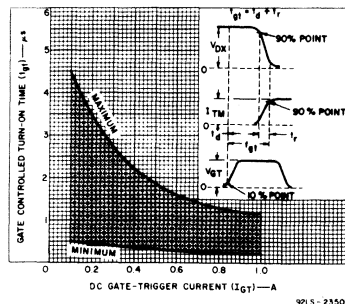


Fig. 9—Turn-on time vs. gate-trigger current.

S3701M

5-A Silicon Controlled Rectifier

For Applications in Pulse Power Supplies To Drive GaAs Laser Diodes

Type S3701M is a silicon controlled rectifier intended for use in circuits which generate pulses to drive injection laser diodes. The S3701M SCR is designed for the good current-spreading and delay-time characteristics necessary to provide high-peak-current pulses to drive the laser diode. An additional signifi-

cant characteristic of this device is its well controlled holding current, which assures operation only at currents sufficiently high to meet the circuit requirements.

The S3701M SCR employs a hermetic JEDEC TO-66 package.

Features:

- High peak-current capability
- Good current-spreading attributes
- Symmetrical gate-cathode construction for uniform current density, rapid electrical conduction, and efficient heat dissipation
- Controlled minimum holding current
- Hermetic construction
- Low thermal resistance

MAXIMUM RATINGS, Absolute-Maximum Values:

Case temperature (T_C) = 25°C, unless otherwise specified

REPETITIVE PEAK OFF-STATE VOLTAGE

Gate open V_{DROM} 600 V

RMS ON-STATE CURRENT (Conduction angle = 180°) I_T(RMS) 5 A

REPETITIVE PEAK ON-STATE CURRENT

(0.2 μs Pulse Width) I_{PM} 75 A

Free-air cooling, f = 500 Hz 40 A

Free-air cooling, f = 5000 Hz 40 A

Infinite heat sink, f = 10,000 Hz 75 A

Infinite heat sink, f = 1,000 Hz 75 A

GATE POWER DISSIPATION: P_{GM} 25 W

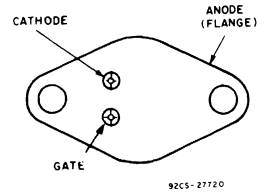
PEAK (For 10 μs pulse) T_{stg} -40 to 125°C

TEMPERATURE RANGE: Operating (Case) T_C -40 to 100°C

TERMINAL TEMPERATURE (During soldering): T_T 225 °C

For 10 s max. (terminals and case)

TERMINAL CONNECTIONS



BOTTOM VIEW

JEDEC TO-66

ELECTRICAL CHARACTERISTICS

At Maximum Ratings and at Indicated Case Temperature (T_C) Unless Otherwise Specified

CHARACTERISTIC	SYMBOL	LIMITS		UNITS
		Min.	Max.	
Peak Off-State Current:				
Gate open, v _D = V _{DROM} , T _C = 25°C	I _{DROM}	—	0.65	mA
T _C = 75°C		—	1.2	
DC Gate-Trigger Current: T _C = 25°C	I _{GT}	—	35	mA
DC Gate-Trigger Voltage: T _C = 25°C	V _{GT}	—	4	V
DC Holding Current:				
Gate open, T _C = 25°C	I _{HO}	15	—	mA
T _C = 75°C		10	—	
Critical Rate-of-Rise of Off-State Voltage:				
For v _D = V _{DROM} , exponential voltage rise, gate open, T _C = 75°C	dv/dt	200	—	V/μs
Source Voltage for Functional Test (See Fig. 2):				
I _p = 75A, C = 0.022μF, R _s = 2Ω, f = 60Hz, pulse duration = 0.2μs, T _C = 25°C	V _s	—	550	V
Thermal Resistance:				
Junction-to-Case	R _{θJC}	—	7	°C/W
Junction-to-Ambient	R _{θJA}	—	40	

S3702S, S3703SF, D2101S, D2103S, D2103SF, S3705M, S3706E, D2600M, D2601E, D2601M

SCR's and Rectifiers for Horizontal-Deflection Circuits

For Large-Screen Color TV

The RCA SCR's S3702S, S3702SF, S3705M, and S3706E and the RCA rectifiers D2101S, D2103S, D2103SF, D2600M, D2601E, and D2601M are designed for use in horizontal output circuits.

The S3703SF silicon controlled rectifier and the D2102SF silicon rectifier are designed to act as a bipolar switch that controls horizontal yoke current during the beam trace interval. The S3702S silicon controlled rectifier and the D2103S silicon rectifier act as the commutating switch to initiate trace-retrace switching and control yoke current during retrace.

The D2101S silicon rectifier may be used as a clamp to protect the circuit components from excessively high transient voltages which may be generated as a result of arcing in the picture tube or in a high-voltage rectifier tube.

To facilitate direct connection across each silicon controlled rectifier, S3702S and S3702SF, the anode connections of sili-

con rectifiers D2103S and D2103SF are reversed as compared to that of a normal power-supply rectifier diode.

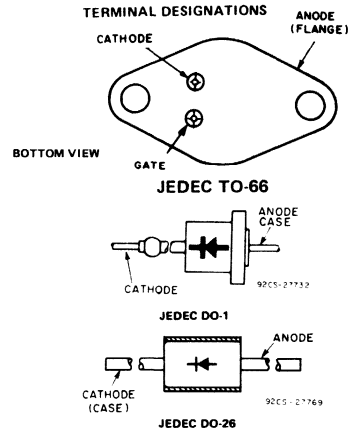
The S3705M silicon controlled rectifier and the D2601M silicon rectifier are designed to act as a bipolar switch that controls horizontal yoke current during the beam trace interval. The S3706E silicon controlled rectifier and the D2601E silicon rectifier act as the commutating switch to initiate trace-retrace switching and control yoke current during retrace.

The D2600M silicon rectifier may be used as a clamp to protect the circuit components from excessively high transient voltages which may be generated as a result of arcing in the picture tube or in a high-voltage rectifier tube.

The SCR's employ a hermetic JEDEC TO-66 package. The rectifier types D2101S, D2103S, and D2103SF employ a hermetic JEDEC TO-1 package. The rectifier types D2600M, D2601E, and D2601M employ a hermetic JEDEC DO-26 package.

Features:

- Operation from supply voltages between 150 and 270 V (nominal)
- Ability to handle high beam current; average 1.6 mA dc
- Ability to supply as much as 5 mJ to 8 mJ of stored energy to the deflection yoke, which is sufficient for 29-mm-neck picture tubes operated at 29 kV or 31 kV (nominal value)
- Highly reliable circuit which can also be used as a low-voltage power supply



SILICON CONTROLLED RECTIFIERS

MAXIMUM RATINGS, Absolute Maximum Values:

	S3703SF TRACE SCR	S3705M	S3702S COMMUTATING SCR	S3706E
NON REPETITIVE PEAK OFF-STATE VOLTAGE: Gate Open	800*	700*	750*	600*
REPETITIVE PEAK REVERSE VOLTAGE: Gate Open	25	25	25	25
REPETITIVE PEAK OFF-STATE VOLTAGE: Gate Open	750	600	700	500
ON-STATE CURRENT T _C = 60°C, 60 Hz sine wave, conduction angle = 180°				
RMS	5	5	5	5
Average DC	3.2	3.2	3.2	3.2
PEAK SURGE (NON-REPETITIVE) ON-STATE CURRENT: For one full cycle of applied principal voltage				
60 Hz (sinusoidal), T _C = 60°C	80	80	80	80
50 Hz (sinusoidal), T _C = 60°C	65	65	65	65
For one-half sine wave, 3 ms pulse width	130	150	130	150
RATE OF CHANGE OF ON-STATE CURRENT: V _D = V _{DROM} , I _{GT} = 50 mA, t _r = 0.1 μs		200		
FUSING CURRENT (for SCR protection): T _J = -40 to 80°C, t = 1 to 10 ms		20		
GATE POWER DISSIPATION: Peak (forward or reverse) for 10 μs duration, max. negative gate bias = -35 V (S3703SF, S3705M) = -10 V (S3702S, S3706E)			25	25
TEMPERATURE RANGE: Storage			-40 to 150	
Operating (Case)			-40 to 80	
PIN TEMPERATURE (During soldering) At distances ≥ 1/32 in. (0.8 mm) from seating plane for 10 s max.			225	

* Protection against transients above these values induced by arcing or other causes must be provided.
 * These values do not apply if there is a positive gate signal. Gate must be open or negatively biased.
 * Any product of gate current and gate voltage which results in a gate power less than the maximum is permitted, provided that the maximum reverse gate bias (as specified) is not exceeded.
 * For temperature measurement reference point, see Dimension Outline.

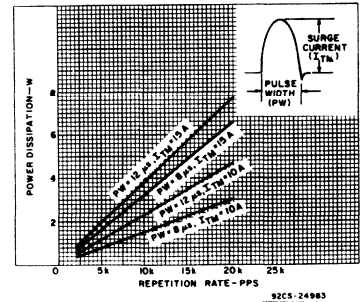


Fig. 1 — Dissipation vs. repetition rate for S3702S and S3702SF.

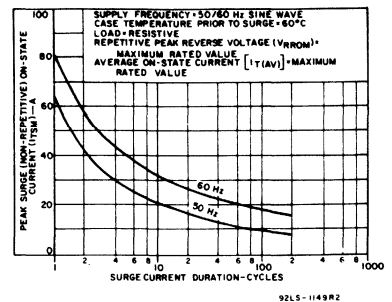


Fig. 2 — Peak surge on-state current vs. surge current duration for S3705M and S3706E.

S3702S, S3703SF, D2101S, D2103S, D2103SF, S3705M, S3706E, D2600M, D2601E, D2601M

SILICON CONTROLLED RECTIFIERS

ELECTRICAL CHARACTERISTICS, At Maximum Ratings Unless Otherwise Specified and at Indicated Case Temperature (T_C)

CHARACTERISTIC	SYMBOL	LIMITS				UNITS	
		S3703SF S3705M TRACE SCR.		S3702S S3706E COMMUT. SCR.			
		TYP.	MAX.	TYP.	MAX.		
Peak Forward Off-State Current: Gate open, $V_D = V_{DROM}$, $T_C = 85^\circ\text{C}$	I_{DOM}	0.5	1.5	0.5	1.5	mA	
Instantaneous On-State Voltage: $I_T = 30\text{ A (peak)}$, $T_C = 25^\circ\text{C}$	V_T	2.2	3	2.2	3	V	
Critical Rate-of-Rise of Off-State Voltage: $V_D = V_{DROM}$, exponential voltage rise, Gate open, $T_C = 70^\circ\text{C}$ S3702S	dv/dt	-		700 (min.) (dv/dt) ₃	V/ μs		
S3706E		175 (min.)		1000 (min.) (dv/dt) ₂			
DC Gate Trigger Current: $V_D = 12\text{ V (dc)}$, $R_L = 30\ \Omega$, $T_C = 25^\circ\text{C}$	I_{GT}	15	32	15	45	mA	
DC Gate Trigger Voltage: $V_D = 12\text{ V (dc)}$, $R_L = 30\ \Omega$, $T_C = 25^\circ\text{C}$	V_{GT}	1.8	4	1.8	4	V	
Circuit Commutated Turn-Off Time: $T_C = 70^\circ\text{C}$, minimum negative gate bias during turn-off time = -20 V (S3703SF, S3705M) and -2.5 V (S3702S, S3706E), rate of reapplied voltage (dv/dt) = 175 V/ μs	t_q	S3703S	-	2.4	-	μs	
S3705M		-	2.5	-	-		
S3702S		-	-	-	4.2		-
S3706E		-	-	-	4.5		-
Thermal Resistance, Junction-to-Case	$R_{\theta JC}$	-	4	-	4	$^\circ\text{C/W}$	

◆ This parameter, the sum of reverse recovery time and gate recovery time, is measured from the zero crossing of current to the start of the reapplied voltage. Knowledge of the current, the reapplied voltage, and the case temperature is necessary when measuring t_q . In the worst conditions (high line, zero-beam, off-frequency, minimum auxiliary load, etc.) turn-off time must not fall below the given values. Turn-off time increases with temperature; therefore, case temperature must not exceed 70°C .

SILICON RECTIFIERS

MAXIMUM RATINGS, Absolute-Maximum Values:

	D2103SF	D2601M	D2103S	D2601E	D2101S	D2600M		
	TRACE		COMMUTATING		CLAMP			
REVERSE VOLTAGE **								
Repetitive Peak	V_{RRM}	750	600	700	500	700	600	
Non-Repetitive Peak	V_{RSM}	800	700	800	600	800	700	
FORWARD CURRENT (operating in 15 kHz deflection circuit):								
RMS	I_{FRMS}	3 \blacklozenge	1.9 \blacklozenge	3 \blacklozenge	1.6 \blacklozenge	1 \blacklozenge	0.5 \blacklozenge	
Peak Surge (Non-Repetitive)	I_{FSM}	70 \blacklozenge	70 \blacklozenge	70 \blacklozenge	70 \blacklozenge	30 \blacklozenge	30 \blacklozenge	
Peak (Repetitive)	I_{FRM}	7	6.5	12	6	0.5	0.5	
TEMPERATURE RANGE								
Storage	T_{stg}					-30 to 150		$^\circ\text{C}$
Operating (Case)	T_C					-30 to 80		$^\circ\text{C}$
LEAD TEMPERATURE (During Soldering) \blacktriangle						225		$^\circ\text{C}$
For 10 s maximum	T_L							

- ** For ambient temperatures up to 45°C .
- \blacklozenge For a maximum of 3 pulses, each less than 10 μs duration, during any 64 μs period.
- \blacklozenge Maximum current rating applies only if the rectifier is properly mounted to maintain junction temperature below 150°C .
- \blacklozenge See Figs. 4 & 5 for I_{FSM} value for 60 Hz.
- \blacktriangle At distances no closer to rectifier body than points A and B on outline drawing.

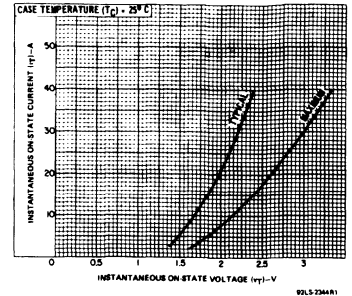


Fig. 3 - Instantaneous on-state current vs. on-state voltage for S3702S and S3703SF.

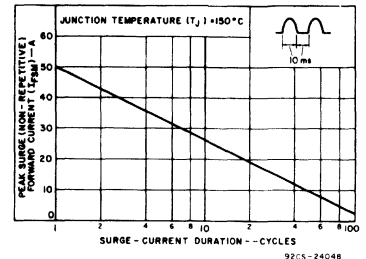


Fig. 4 - Peak surge (non-repetitive) forward current vs. surge-current duration for D2101S, D2103S, and D2103SF.

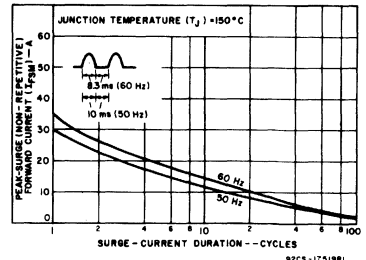


Fig. 5 - Peak-surge (non-repetitive) forward current vs. surge-current duration for D2600M, D2601E, and D2601M.

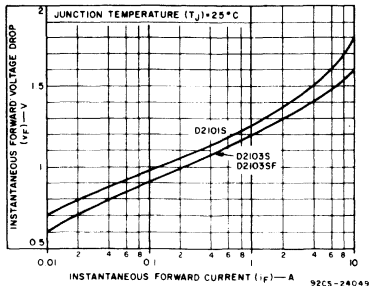


Fig. 6 - Forward-voltage drop vs. forward current for D2101S, D2103S, and D2103SF.

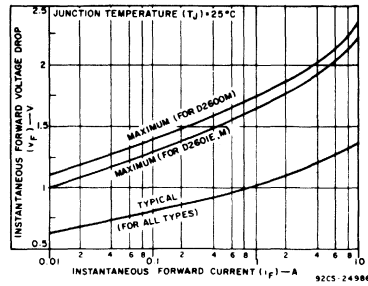


Fig. 7 - Forward-voltage drop vs. forward current for D2600M, D2601E, and D2601M.

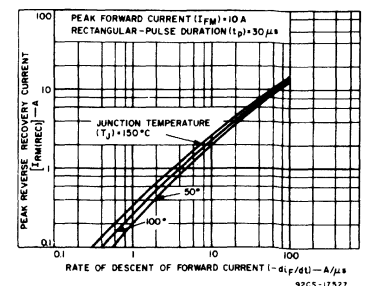


Fig. 8 - Typical peak reverse-recovery current vs. rate of descent of forward current for all rectifiers.

S3702S, S3703SF, D2101S, D2103S, D2103SF, S3705M, S3706E, D2600M, D2601E, D2601M

SILICON RECTIFIERS

ELECTRICAL CHARACTERISTICS,

CHARACTERISTIC	SYMBOL	LIMITS		UNITS
		D2103SF D2601M	D2101S D2600M	
		TRACE D2103S D2601E	CLAMP	
		MAXIMUM	MINIMUM	
Reverse Current: Static For $V_{RRM} = \text{max. rated value, } I_F = 0, T_C = 25^\circ\text{C}$ For $V_R = 500\text{ V, } T_C = 100^\circ\text{C}$	I_{RM}	10 250	10 250	μA
Instantaneous Forward Voltage Drop: At $I_F = 4\text{ A, } T_A = 25^\circ\text{C}$ (See Fig. 6, 7)	V_F	1.4 (D2103SF, D2103S)	1.5 (D2101S)	V
Reverse Recovery Time: At $I_{FM} = 3.14\text{ A, } -di_F/dt = -10\text{ A}/\mu\text{s}$, pulse duration = $0.94\ \mu\text{s, } T_C = 25^\circ\text{C}$ At $I_{FM} = 20\text{ A, } -di_F/dt = -20\text{ A}/\mu\text{s}$, pulse duration = $2.8\ \mu\text{s, } T_C = 25^\circ\text{C}$ In Tektronix type "S" plug-in unit (or equivalent): At $I_F = 20\text{ mA, } I_R = 1\text{ mA, } T_C = 25^\circ\text{C}$	t_{rr}	0.5 (D2103SF, D2103S) 0.5 (D2601M, D2601E)	0.7 (D2101S) 0.7 (D2600M)	μs
Peak Forward Voltage Drop (at turn-on): In Tektronix type "S" plug-in unit (or equivalent): At $I_F = 20\text{ mA, } T_C = 25^\circ\text{C}$	$V_{F(pk)}$	5	6	V
Thermal Resistance (Junction-to-Case) [▲]	$R_{\theta JC}$	10 (D2103SF, D2103S)	10 (D2101S)	$^\circ\text{C}/\text{W}$
Thermal Resistance (Junction-to-Lead) [▲] (See Fig. 11)	$R_{\theta JL}$	45 (D2601M, D2601E)	45 (D2600M)	

[▲] Measured at point as indicated on Dimensional Outline.
[◆] Measured on anode lead 1/8 in. (3.18 mm) from case.

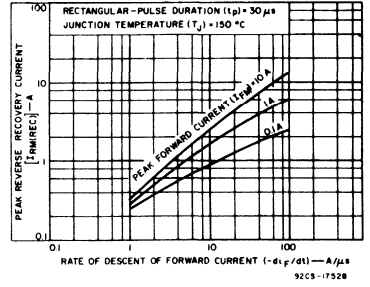


Fig. 9 – Typical peak reverse-recovery current vs. rate of descent of forward current for all rectifiers.

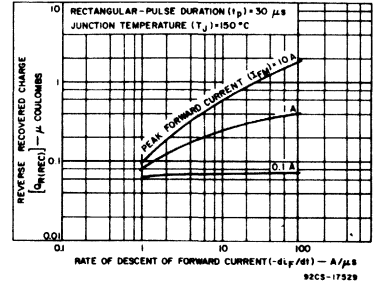


Fig. 10 – Typical reverse-recovered charge vs. rate of descent of forward current for all rectifiers.

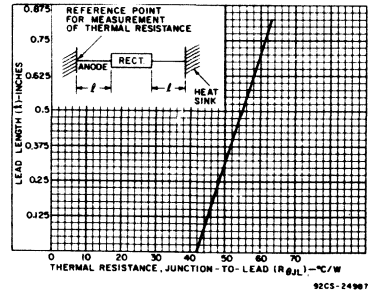


Fig. 11 – Junction-to-lead thermal resistance vs. lead length for D2600M, D2601E, and D2601M.

S3900, S3901, S3902DF, S3903MF Series

Monolithic Integrated Thyristor/Rectifiers (ITR's) for TV Horizontal-Deflection Circuits

Color and Monochrome

The RCA-S3900- and S3901-series and the S3902DF and S3903MF integrated thyristor/rectifiers are all-diffused power monolithic circuits that incorporate a silicon controlled rectifier and a silicon rectifier on a common pellet. The S3900-series and S3902DF types are used as bipolar switches to control horizontal yoke current during the beam trace interval; the S3901-series and S3903MF types are used as commutating switches to initiate trace-retrace switching.

The S3900 and S3901-series ITR's are designed for use in color TV circuits. Devices in the S3900 series are capable of supplying

8 mJ of stored energy to the deflection yoke; this is sufficient for 29-mm-neck and 35-mm-neck color picture tubes operated at a nominal value of 31 kV.

The S3902DF and S3903MF types are intended for use in black-and-white TV circuits. The S3903DF ITR is capable of supplying 3 mJ of stored energy to the deflection yoke; this is sufficient for 29-mm-neck monochrome tubes operated at 19 kV nominal value.

All types in these four series are supplied in the JEDEC TO-220AB package. The plastic used in this package is a flame-retardant material.

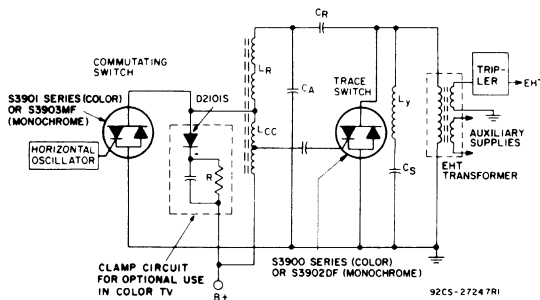


Fig. 1 - Simplified schematic diagram of horizontal output circuit.

ITR's FOR COLOR TELEVISION

MAXIMUM RATINGS, Absolute-Maximum Values:

	TRACE				COMMUTATING			
	S3900E	S3900MF	S3900S	S3900SF	S3901M	S3901MF	S3901S	
V_{DSM} : $T_C = 85^\circ C$	550	700	750	800	650	700	750	V
V_{RRM} : $T_C = 85^\circ C$	4	4	4	4	4	4	4	V
V_{DRM} : $T_C = 85^\circ C$	500	650	700	750	600	650	700	V
CURRENT: $T_C = 60^\circ C$, 50 Hz sine wave, $\theta = 180^\circ$								
Rectifier Unit:					3			A
$I_F(RMS)$					4.5			A
SCR Unit:								
$I_T(AV)$					5			A
$I_T(RMS)$					8			A
I_{TSM} : For one full cycle of applied principal voltage:								
60 Hz (sinusoidal), $T_C = 85^\circ C$:					80			A
Rectifier Unit, I_{FSM}					80			A
SCR Unit, I_{TSM}								
50 Hz (sinusoidal), $T_C = 85^\circ C$:					70			A
Rectifier Unit, I_{FSM}					70			A
SCR Unit, I_{TSM}								
For more than one full cycle of applied principal voltage					See Figs. 6 and 7			
For one-half sine wave, $t_p = 3$ ms:								
Rectifier Unit, I_{FSM}					150			A
SCR Unit, I_{TSM}					150			A

Features:

- Operation from nominal supply voltages between:
 - 100 V and 240 V - S3902DF, S3903MF
 - 140 V and 270 V - S3900, S3901 Series
- Ability to handle high beam currents:
 - 1 mA dc (avg.) - S3902DF, S3903MF
 - 1.6 mA dc (avg.) - S3900, S3901 Series
- Ability to supply stored energy to the deflection yoke, as much as:
 - 3 mJ for 19 kV (nom.) monochrome tubes - S3902DF
 - 8 mJ for 31 kV (nom.) color TV tubes - S3900 Series
- Highly reliable circuit which can also be used as a low-voltage power supply

TERMINAL CONNECTIONS

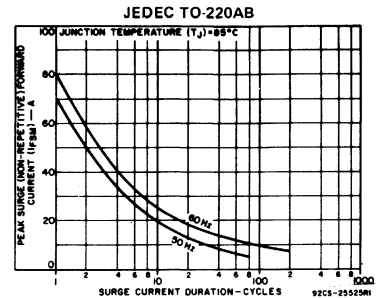
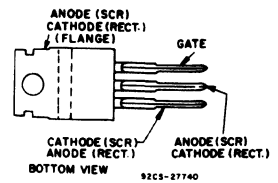


Fig. 2 - Peak surge forward current vs. surge-current duration for rectifier unit of ITR (all types).

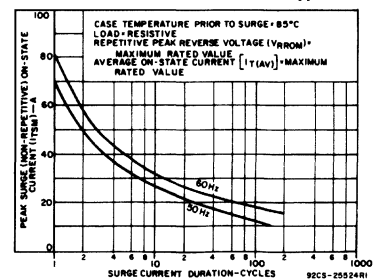


Fig. 3 - Peak surge on-state current vs. surge-current duration for SCR unit of ITR (all types).

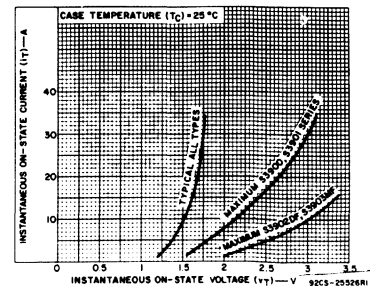


Fig. 4 - Instantaneous on-state current vs. on-state voltage for SCR unit of ITR (all types).

S3900, S3901, S3902DF, S3903MF Series

ITR's FOR COLOR TELEVISION

MAXIMUM RATINGS, Absolute-Maximum Values: (Cont'd)

	TRACE		COMMUTATING		
	S3900MF	S3900S	S3900SF	S3901M S3901MF S3901S	
di/dt:					
$V_D = V_{DROM}, I_{GT} = 50 \text{ mA},$ $t_r = 0.1 \mu\text{s}$	200				A/ μs
I^2t (For ITR protection):					
$T_J = -40 \text{ to } 85^\circ\text{C}, t = 1 \text{ to } 10 \text{ ms}$	30				A ² s
PGM: Forward or reverse for 10 μs duration, max. negative gate bias = -10 V	25				W
T_{stg}	-40 to 150				$^\circ\text{C}$
T_C	-40 to 85				$^\circ\text{C}$
T_T (During soldering): At distances $\geq 1/8 \text{ in. (3.17 mm)}$ from case for 10 s max.	225				$^\circ\text{C}$

- *Protection against transients above these values induced by arcing or other causes must be provided.
- These values do not apply if there is a positive gate signal. Gate must be open or negatively biased.
- Any product of gate current and gate voltage which results in a gate power less than the maximum is permitted, provided that the maximum reverse gate bias (as specified) is not exceeded.
- For temperature measurement reference point, see Dimensional Outline.

ELECTRICAL CHARACTERISTICS FOR ITR's FOR COLOR-TELEVISION CIRCUITS At Maximum Ratings and at Case Temperature (T_C) = 25°C Unless Otherwise Specified

CHARACTERISTIC	LIMITS				UNITS
	S3900 Series TRACE ITR		S3901 Series COMMUTATING ITR		
	TYP.	MAX.	TYP.	MAX.	
I_{DOM} : $V_D = V_{DROM}, T_C = 85^\circ\text{C}$	0.5	1.5	0.5	1.5	mA
V_T : SCR Unit: $i_T = 30 \text{ A}$ (See Fig. 4)	1.75	3	1.75	3	V
V_F : Rectifier Unit: $i_F = 10 \text{ A}$ (See Fig. 5)	1.35	1.7	1.35	2	V
dv/dt: $V_D = V_{DROM}, T_C = 85^\circ\text{C}$ $V_G = -2.5 \text{ V min. (S3901 Series)}$	175 (min.)		1000 (min.) (dv/dt) ₂		V/ μs
I_{GT} : $V_D = 12 \text{ V dc}, R_L = 30 \Omega$	15	40	15	45	mA
V_{GT} : $V_D = 12 \text{ V dc}, R_L = 30 \Omega$	1.8	4	1.8	4	V
t_q : $T_C = 80^\circ\text{C}$ Minimum negative gate bias = -20 V (S3900 Series) = -2.5 V (S3901 Series) dv/dt = 175 V/ μs (S3900 Series)	-	2.4	-	-	μs
dv/dt = 400 V/ μs (S3901 Series)	-	-	-	4.2	

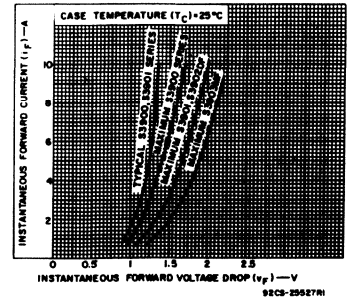


Fig. 5 — Instantaneous forward current vs. forward voltage drop for rectifier unit of ITR (all types).

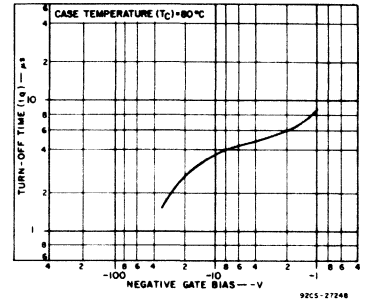


Fig. 6 — Typical turn-off time vs. gate bias for S3900-series types.

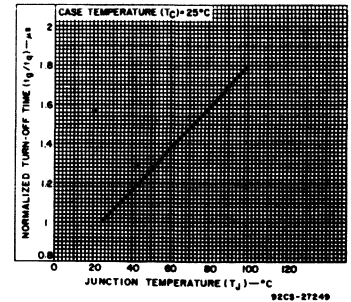


Fig. 7 — Normalized turn-off time vs. junction temperature for S3900- and S3901-series types.

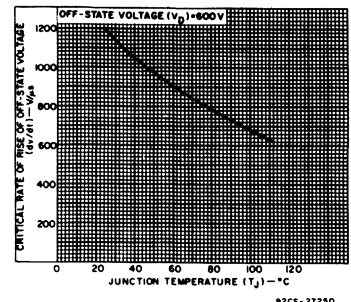


Fig. 8 — Typical dv/dt vs. junction temperature for S3900- and S3901-series types.

S3900, S3901, S3902DF, S3903MF Series

ELECTRICAL CHARACTERISTICS FOR ITR's FOR COLOR-TELEVISION CIRCUITS (Cont'd)
At Maximum Ratings and at Case Temperature (T_C) = 25°C Unless Otherwise Specified

CHARACTERISTIC	LIMITS				UNITS
	S3900 Series TRACE ITR		S3901 Series COMMUTATING ITR		
	TYP.	MAX.	TYP.	MAX.	
t _{rr} : Rectifier Unit: I _{FM} = 10 A, -di _F /dt = -10 A/μs, t _p = 3 μs	0.5	0.7	0.5	0.7	μs
V _{FM} (At t _g): Rectifier Unit: I _{FM} = 1 A	8	13	-	-	V
R _{θJC} [▲]	-	2.5	-	2.5	°C/W

♦ Turn-off time increases with temperature; therefore, case temperature must not exceed the level indicated.
▲ Measured at point indicated on Dimensional Outline.

ITR's FOR MONOCHROME TELEVISION

MAXIMUM RATINGS, Absolute-Maximum Values:

	TRACE	COMMUTATING	
	S3902DF	S3903MF	
V _{DSOM} ^{♦♦} T _C = 85°C	500	700	V
V _{RROM} [♦] T _C = 85°C	4	4	V
V _{DROM} [♦] T _C = 85°C	450	650	V
CURRENT: T _C = 60°C, 50 Hz sine wave, θ = 180°: Rectifier Unit:			
I _o	3		A
I _{F(RMS)}	4.5		A
SCR Unit:			
I _{T(AV)}	5		A
I _{T(RMS)}	8		A
I _{TSM} [♦] For one full cycle of applied principal voltage: 60 Hz (sinusoidal), T _C = 85°C: Rectifier Unit, I _{FSM}	80		A
SCR Unit, I _{TSM}	80		A
50 Hz (sinusoidal), T _C = 85°C: Rectifier Unit, I _{FSM}	70		A
SCR Unit, I _{TSM}	70		A
For more than one full cycle of applied principal voltage	See Figs. 2 and 3		
For one-half sine wave, t _p = 3 ms: Rectifier Unit, I _{FSM}	150		A
SCR Unit, I _{TSM}	150		A
di/dt: V _D = V _{DROM} , I _{GT} = 50 mA, t _r = 0.1 μs	200		A/μs
i ² t (For ITR protection): T _J = -40 to 85°C, t = 1 to 10 ms	30		A ² s
P _{GM} [♦] Forward or reverse for 10 μs duration, max. negative gate bias = -10 V	25		W
T _{stg} [▲]	-40 to 150		°C
T _C [▲]	-40 to 85		°C
T _T (During soldering): At distance ≥ 1/8 in. (3.17 mm) from case for 10 s max.	225		°C

*Protection against transients above these values induced by arcing or other causes must be provided.
♦ These values do not apply if there is a positive gate signal. Gate must be open or negatively biased.
♦ Any product of gate current and gate voltage which results in a gate power less than the maximum is permitted, provided that the maximum reverse gate bias (as specified) is not exceeded.
♦ For temperature measurement reference point, see Dimensional Outline.

ELECTRICAL CHARACTERISTICS FOR ITR's FOR MONOCHROME TELEVISION CIRCUITS
At Maximum Ratings and at Case Temperature (T_C) = 25°C Unless Otherwise Specified

CHARACTERISTIC	LIMITS				UNITS
	S3902DF TRACE ITR		S3903MF COMMUTATING ITR		
	TYP.	MAX.	TYP.	MAX.	
I _{DROM} : V _D = V _{DROM} , T _C = 85°C	0.5	1.5	0.5	1.5	mA
v _T : SCR Unit: I _T = 10 A (See Fig. 4)	1.75	3	1.75	3	V
v _{FF} : Rectifier Unit: I _F = 4 A (See Fig. 5)	1.35	1.6	1.35	1.8	V
dv/dt: V _D = V _{DROM} , T _C = 85°C V _G = -2.5 V min. (S3903MF)	120 (min.)		700 (min.) (dv/dt) ₂		V/μs
I _{GT} : V _D = 12 V dc, R _L = 30 Ω	15	40	15	45	mA
V _{GT} : V _D = 12 V dc, R _L = 30 Ω	1.8	4	1.8	4	V
t _q [♦] T _C = 80°C Minimum negative gate bias = -20 V (S3902DF) = -2.5 V (S3903MF) dv/dt = 120 V/μs (S3902DF) dv/dt = 400 V/μs (S3903 Series)	-	3	-	-	μs
t _{rr} : Rectifier Unit: I _{FM} = 3.14 A, -di _F /dt = -10 A/μs, t _p = 0.94 μs	0.3	0.5	0.3	0.5	μs
V _{FM} (At t _g): Rectifier Unit: I _{FM} = 1 A	8	13	-	-	V
R _{θJC} [▲]	-	2.5	-	2.5	°C/W

♦ Turn-off time increases with temperature; therefore, case temperature must not exceed the level indicated.
▲ Measured at point indicated on Dimensional Outline.

S4000(2N3668-2N3670,2N4103) Series

12.5-A Silicon Controlled Rectifiers

For Low-Cost Power-Control and Power-Switching Applications

RCA 2N3668*, 2N3669*, 2N3670*, and 2N4103* are all-diffused, three-junction, silicon controlled-rectifiers (SCR's). They are intended for use in power-control and power-switching applications requiring a blocking voltage capability of up to 600 volts and a forward-current capability of 12.5 amperes (rms value) or 8 amperes (average value) at a case temperature of 80°C.

The 2N3668 is designed for low voltage power supplies, the 2N3669 for direct operation from 120-volt line supplies, the 2N3670 for direct operation from 240-volt line supplies, and the 2N4103 for high-voltage power supplies.

The 2N3668, 2N3669, 2N3670 and 2N4103 SCR's employ the hermetic JEDEC TO-3 package.

*Formerly Dev. Types TA2621, TA2598, TA2618, and TA2775, respectively.

Absolute-Maximum Ratings, for Operation with Sinusoidal AC Supply Voltage at a Frequency between 50 and 400 Hz, and with Resistive or Inductive Load

RATINGS	CONTROLLED-RECTIFIER TYPES				UNITS
	2N3668	2N3669	2N3670	2N4103	
Transient Peak Reverse Voltage (Non-Repetitive), $V_{RM}(non-rep)$	150	330	660	700	volts
Peak Reverse Voltage (Repetitive), $V_{RM}(rep)$	100	200	400	600	volts
Peak Forward Blocking Voltage (Repetitive), $V_{FBOM}(rep)$	100	200	400	600	volts
Forward Current: For case temperature (T_C) of +80°C Average DC value at a conduction angle of 180°, I_{FAV}	8	8	8	8	amperes
RMS value, I_{FRMS}	12.5	12.5	12.5	12.5	amperes
For other conditions, (See Fig. 4)					
Peak Surge Current, I_{FSM} (surge): For one cycle of applied voltage	200	200	200	200	amperes
For one cycle of applied principal voltage 60 Hz (sinusoidal), $T_C = 80°C$	200	200	200	200	amperes
50 Hz (sinusoidal), $T_C = 80°C$	170	170	170	170	amperes
For more than one cycle of applied voltage	See Fig. 2	See Fig. 2	See Fig. 2	See Fig. 2	
Fusing Current (for SCR protection): $T_J = -40$ to $100°C$, $t = 1$ to 8.3 ms, $12t$	170	170	170	170	ampere ² second
Rate of Change of Forward Current, di/dt $V_{FB} = V_{BOM}(min. value)$ $I_{CT} = 200mA, 0.5...s$ rise time	200	200	200	200	amperes/microsecond
Gate Power: Peak, Forward or Reverse, for 10...s duration, P_{GM} (See Figs. 5 and 6)	40	40	40	40	watts
Average, P_{GAV}	0.5	0.5	0.5	0.5	watt
Temperature: Storage, T_{stg}	-40 to +125	-40 to +125	-40 to +125	-40 to +125	°C
Operating (Case), T_C	-40 to +100	-40 to +100	-40 to +100	-40 to +100	°C

- *Any values of peak gate current or peak gate voltage to give the maximum gate power is permissible.
- Temperature reference point is within 1/8 in. (3.17 mm) of the center of the underside of unit.

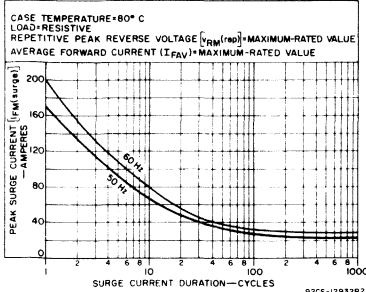


Fig. 1 — Peak surge current vs. surge current duration.

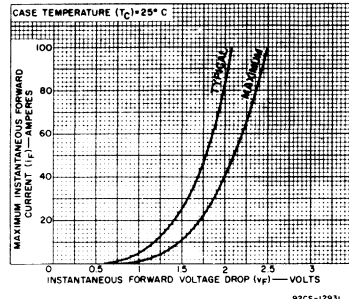


Fig. 2 — Instantaneous forward current vs. instantaneous forward voltage drop.

Features:

- Low switching losses
- High di/dt and dv/dt capabilities
- Shorted emitter gate-cathode construction
- Forward and reverse gate dissipation ratings
- Designed especially for high-volume systems
- All-diffused construction — assures exceptional uniformity and stability of characteristics
- Direct-soldered internal construction — assures excellent resistance to fatigue
- Symmetrical gate-cathode construction — provides uniform current density, rapid electrical conduction, and efficient heat dissipation
- All-welded construction and hermetic sealing
- Low leakage currents, both forward and reverse
- Low forward voltage drop at high current levels
- Low thermal resistance

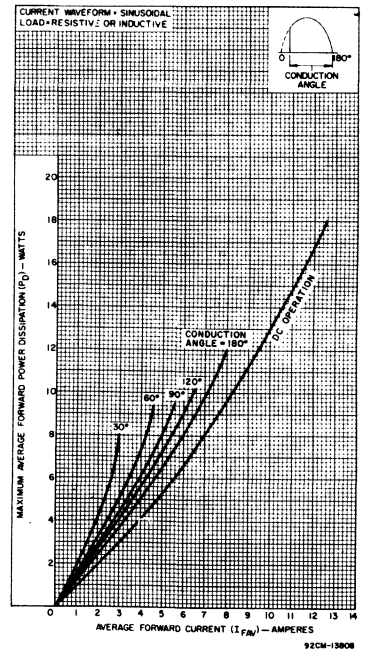
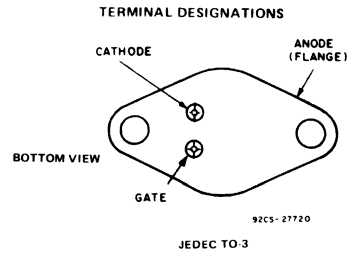


Fig. 3 — Power dissipation vs. forward current.

S4000(2N3668-2N3670,2N4103) Series

ELECTRICAL CHARACTERISTICS

Characteristics at Maximum Ratings (unless otherwise specified), and at Indicated Case Temperature (T_C)

CHARACTERISTICS	CONTROLLED-RECTIFIER TYPES												UNITS
	2N3668			2N3669			2N3670			2N4103			
	Min.	Typ.	Max.	Min.	Typ.	Max.	Min.	Typ.	Max.	Min.	Typ.	Max.	
Peak Repetitive Blocking Voltage, V_{DROM} At $T_C = +100^\circ\text{C}$	100	-	-	200	-	-	400	-	-	600	-	-	volts
Peak Blocking Current, at $T_C = +100^\circ\text{C}$: Forward, I_{DOM}	-	0.2	2	-	0.25	2.5	-	0.3	3	-	0.35	4	mA
Reverse, I_{ROM}	-	0.05	1	-	0.1	1.25	-	0.2	1.5	-	0.3	3	mA
Forward Voltage Drop, V_F At a Forward Current of 25 amperes and a $T_C = +25^\circ\text{C}$ (See Fig. 2)	-	1.5	1.8	-	1.5	1.8	-	1.5	1.8	-	1.5	1.8	volts
DC Gate-Trigger Current, I_{GT} : At $T_C = +25^\circ\text{C}$ (See Fig. 5)	1	20	40	1	20	40	1	20	40	1	20	40	mA(dc)
Gate-Trigger Voltage, V_{GT} : At $T_C = +25^\circ\text{C}$ (See Fig. 5)	-	1.5	2	-	1.5	2	-	1.5	2	-	1.5	2	volts (dc)
Holding Current, I_{H00} : At $T_C = +25^\circ\text{C}$	0.5	25	50	0.5	25	50	0.5	25	50	0.5	25	50	mA
Critical Rate of Applied Forward Voltage, $V_{FB} = V_{B00}$ (min. value), exponential rise, $T_C = +100^\circ\text{C}$	10	100	-	10	100	-	10	100	-	10	100	-	volts/ microsecond
Turn-On Time, t_{on} , (Delay Time + Rise Time) $V_{FB} = V_{B00}$ (min. value), $i_F = 8$ amperes, $I_{GT} = 200$ mA, 0.1 μ s rise time, $T_C = +25^\circ\text{C}$	0.75	1.25	-	0.75	1.25	-	0.75	1.25	-	0.75	1.25	-	microseconds
(See waveshapes of Fig. 3)													
Turn-Off Time, t_{off} , (Reverse Recovery Time + Gate Recovery Time)	-	20	50	-	20	50	-	20	50	-	20	50	microseconds
$i_F = 8$ amperes, 50 μ s pulse width, $dv_{FB}/dt = 20$ V/ μ s, $di_F/dt = 30$ A/ μ s, $I_{GT} = 200$ mA, $T_C = +80^\circ\text{C}$													
Thermal Resistance, Junction-to-Case,	-	-	1.7	-	-	1.7	-	-	1.7	-	-	1.7	$^\circ\text{C}/\text{W}$

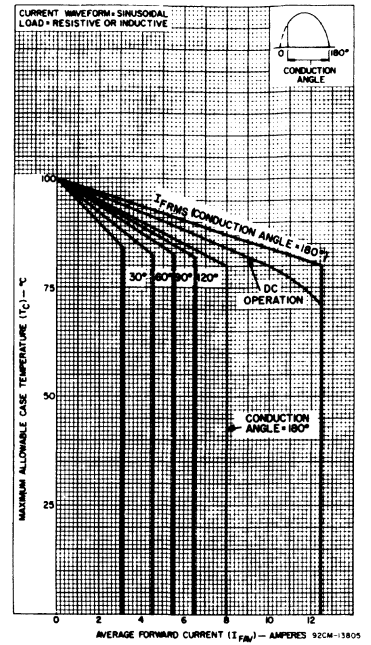


Fig. 4 - Maximum allowable case temperature vs. average forward current.

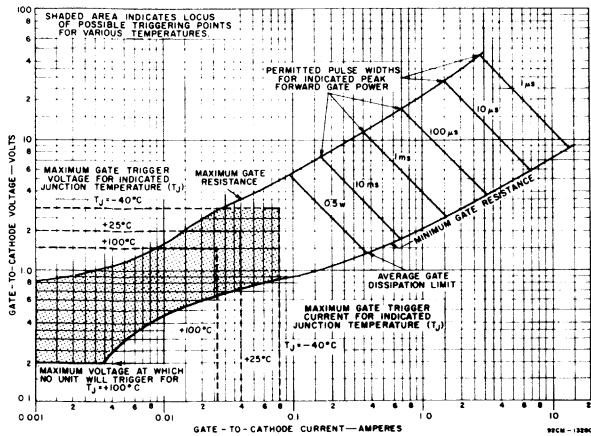


Fig. 5 - Forward gate characteristics.

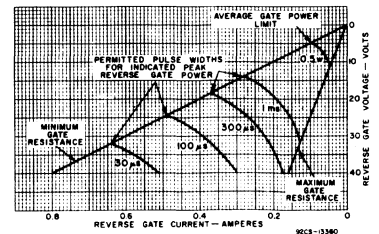


Fig. 6 - Reverse gate characteristics.

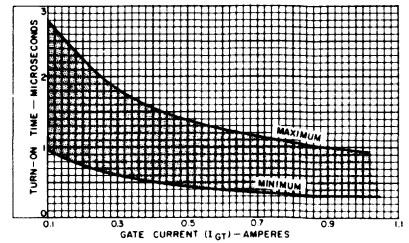


Fig. 7 - Turn-on time vs. gate current.

S4000(2N3668-2N3670, 2N4103) Series

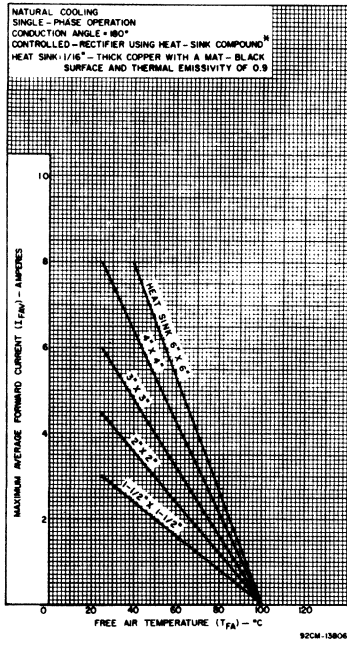


Fig. 8 - Natural-cooling operation guidance chart.

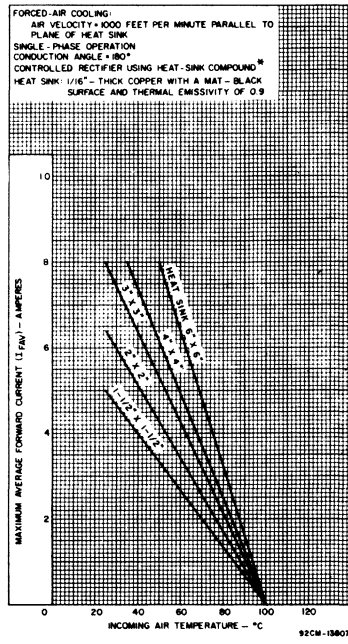


Fig. 9 - Forced-air cooling operation guidance chart.

*Dow Corning 340 Silicon Heat Sink Compound, or Equivalent.

S5800, S5801, S5802 Series

5-A Silicon Controlled Rectifiers

For Inverter/Regulator Applications

The RCA-S5800, S5801, and S5802 are all-diffused silicon controlled rectifiers (reverse-blocking triode thyristors) intended for high-speed switching applications such as power inverters, switching regulators, and high-current pulse applications. They feature fast

turn-off, high dv/dt, and high di/dt characteristics and may be used at frequencies up to 25 kHz.

All types in each series utilize the JEDEC-TO-220AB (RCA VERSAWATT) plastic package.

MAXIMUM RATINGS,

Absolute-Maximum Values:

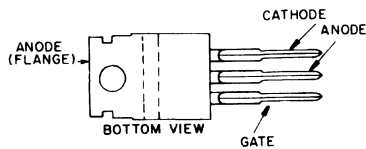
	6 μ s (t_q)	S5800B	S5800C	S5800D	S5800E	S5800M	
	10 μ s (t_q)	S5801B	S5801C	S5801D	S5801E	S5801M	
	15 μ s (t_q)	S5802B	S5802C	S5802D	S5802E	S5802M	
V_{RSOM}^*	}	250	350	450	550	650	V
V_{DSOM}^*							V
V_{RROM}^*							V
V_{DROM}^*	}	200	300	400	500	600	V
$I_{T(RMS)}$ ($T_C = 60^\circ C, t_1/t_2 = 0.5$)							A
$I_{T(AV)}$ ($T_C = 60^\circ C, t_1/t_2 = 0.5$)							A
I_{TSM}^*							
For one full cycle of applied principal voltage							
60-Hz (sinusoidal)				80			A
50-Hz (sinusoidal)				75			A
For more than one cycle of applied principal voltage				See Fig. 4			
di/dt: (See Fig. 9)							
$V_{DM} = V_{DROM}, I_{GT} = 500$ mA,							
$t_r = 0.5$ μ s				200			A/ μ s
I^2T [At T_C shown for $I_{T(RMS)}$]:							
$t = 10$ ms				28			A ² s
8.3 ms				26			A ² s
1 ms				13			A ² s
For other time values.				See Fig. 5			
P_{GM}^*							
Peak forward for 10 μ s max.				13			W
P_{RGM}^*							
Peak reverse for 10 μ s max.				13			W
$P_G(AV)^*$							
Averaging time = 10 μ s max.				0.5			W
T_{stg}^*				-40 to 150			$^\circ C$
T_C^*				-40 to 100			$^\circ C$
T_J^* (During soldering for 10 s maximum, terminals and case)				225			$^\circ C$

- * For temperature measurement reference point, see Dimensional Outline.
- † These values do not apply if there is a positive gate signal. Gate must be open or negatively biased.
- Any product of gate current and gate voltage which results in a gate power less than the maximum is permitted.

Features:

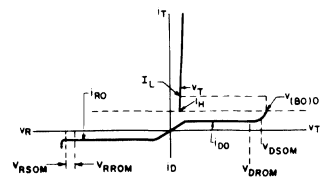
- Fast turn-off time (t_q) = 6 μ s max. (S5800 series)
- High di/dt and dv/dt capabilities
- Shorted-emitter gate-cathode construction. . . contains an internally diffused resistor between gate and cathode
- Low thermal resistance
- Center-gate construction . . . provides rapid uniform gate-current spreading for faster turn-on with substantially reduced heating effects

TERMINAL CONNECTIONS



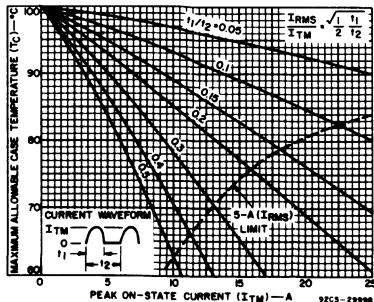
92CS-27721

JEDEC TO-220AB



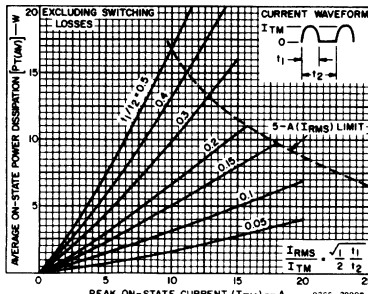
9255-3896R5

Fig. 1 — Principal voltage-current characteristic.



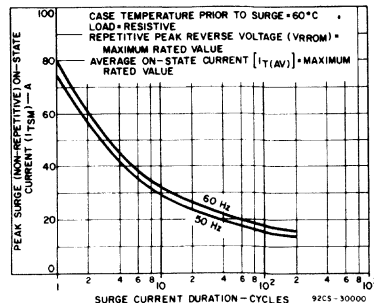
92CS-29996

Fig. 2 — Maximum allowable case temperature as a function of peak on-state current.



92CS-29999

Fig. 3 — Average on-state power dissipation as a function of peak on-state current.



92CS-30000

Fig. 4 — Peak surge on-state current as a function of surge duration.

S5800, S5801, S5802 Series

ELECTRICAL CHARACTERISTICS

As Maximum Ratings Unless Otherwise Specified and at Indicated Case Temperature (T_C)

CHARACTERISTIC	LIMITS			UNITS
	FOR ALL TYPES			
	Min.	Typ.	Max.	
$I_{DROM}^:$ $V_D = V_{DROM}, T_C = 100^\circ C$	—	0.5	3	mA
$I_{RROM}^:$ $V_R = V_{RROM}, T_C = 100^\circ C$	—	0.3	1.5	
$V_T:$ $I_{TM} = 30 A (peak), T_C = 25^\circ C$ (See Fig. 6) S5800 series S5801 and S5802 series	—	2.34	4	V
$i_{HQ}^:$ $T_C = 25^\circ C$	—	20	50	mA
$dv/dt:$ (Linear) $V_D = V_{DROM}, T_C = 80^\circ C$ (See Fig. 10)	100	250	—	V/ μs
$I_{GT}^:$ $V_D = 12 V dc, R_L = 30 \Omega, T_C = 25^\circ C$	—	—	50	mA
$V_{GT}^:$ $V_D = 12 V dc, R_L = 30 \Omega, T_C = 25^\circ C$	—	1.2	2.5	V
$t_{gt}^:$ (See Fig. 11) $V_D = V_{DROM}, i_T = 8 A (peak), I_{GT} = 300 mA,$ $t_r = 0.1 \mu s, T_C = 25^\circ C$	—	0.7	—	μs
$t_q^:$ (See Figs. 8, 12, 13) $\frac{1}{2}$ Sine Wave $V_D = V_{DROM},$ pulse duration = 50 $\mu s,$ $dv/dt = 100 V/\mu s, -di/dt = -10 A/\mu s, I_{GT} = 100 mA$ at turn on, $V_{GK} = 0 V$ at turn off, $T_C = 75^\circ C:$ $i_T = 4 A$ S5800 series S5801 series S5802 series $i_T = 8 A$ S5800 series S5801 series S5802 series	—	4.4 6.8 11 —	— — — 6 10 15	μs
$R_{\theta JC}$	—	—	2.2	$^\circ C/W$

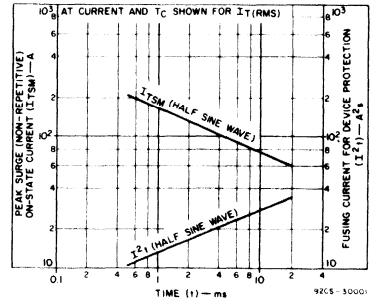


Fig. 5 - Peak surge on-state current and fusing current as a function of time.

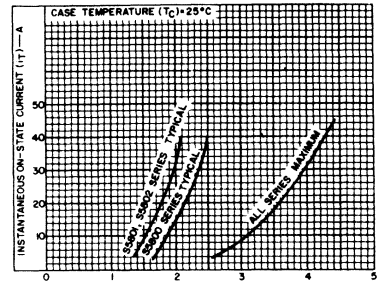


Fig. 6 - Instantaneous on-state current as a function of instantaneous on-state voltage.

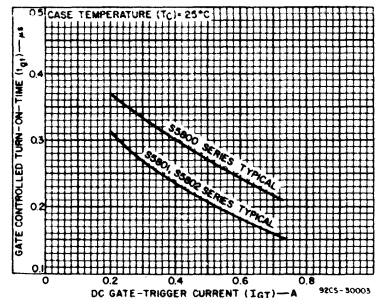


Fig. 7 - Gate-controlled turn-on time as a function of gate current.

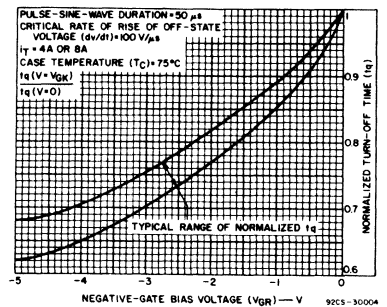


Fig. 8 - Normalized turn-off time as a function of negative-gate bias voltage.

S6000 (2N6394-2N6398; S6000C, S6000E, S6000S) S6100 (2N6400-2N6404; S6100C, S6100E, S6100S) Series

12-A and 16-A Silicon Controlled Rectifiers

For Power Switching, Power Control, and Ignition Applications

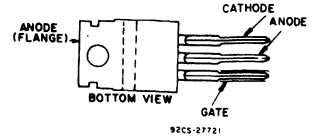
The RCA-2N6394 to 2N6398, inclusive, and 2N6400 to 2N6404, inclusive, and the S6000C, S6000E, S6000S, S6100C, S6100E, and S6100S are all-diffused silicon controlled rectifiers (reverse-blocking triode thyristors) designed for switching ac and dc currents. These devices can switch from the off-state to the on-state when both the anode and gate voltages are positive. Negative anode voltages make

these devices revert to the blocking state. The TO-220AB package provides easy package mounting and low thermal resistance, allowing operation at high case temperatures and permitting reduced heat-sink size. These SCR's can be used in lighting and motor-speed control, capacitor-discharge ignition circuits, high-voltage generators, automotive applications, and power-switching systems.

Features:

- High dv/dt capability
- Low thermal resistance
- Shorted-emitter center gate design
- Low on-state voltage at high current levels
- Glass passivated junctions

TERMINAL CONNECTIONS



JEDEC TO-220AB

MAXIMUM RATINGS, Absolute-Maximum Values:

	2N6394 2N6400	2N6395 2N6401	2N6396 2N6402	S6000C S6100C	2N6397 2N6403	S6000E S6100E	2N6398 2N6404	S6000S S6100S	
V_{RSOM}^{Δ}	75	125	250	350	450	550	650	750	V
V_{DSOM}^{Δ}	75	125	250	350	450	550	650	750	V
V_{RRM}^{Δ}	50	100	200	300	400	500	600	700	V
V_{DRM}^{Δ}	50	100	200	300	400	500	600	700	V
$T_{T(RMS)}$ $\theta = 180^{\circ}C$					12				A
$T_C = 90^{\circ}C$ - 2N6394-98, S6000 series					16				A
$T_C = 100^{\circ}C$ - 2N6400-04, S6100 series									
T_{TSM}^{Δ}									
For one full cycle of applied principal voltage									
60-Hz† - 12-A types					125 [♦]				A
16-A types					160				A
50-Hz† - 12-A types					105				A
16-A types					135				A
For more than one full cycle of applied principal voltage					See Fig. 7, 8				
di/dt									
$V_D = V_{DRM}$; $I_{GT} = 80$ mA, $t_r = 0.1$ μ s					100				A/ μ s
i^2t :									
$T_J = -40$ to $125^{\circ}C$					65				A ² s
$t = 1$ to 8.3 ms - 12-A types					100				A ² s
16-A types									
P_{GM}^{Δ}					16 [♦]				W
Peak forward for 10 μ s max.					See Fig. 13				
Peak reverse									
$P_{G(AV)}^{\Delta}$					0.5				W
Averaging time = 8 ms maximum					2				A
I_{GM} ; (forward)					-40 to 150				$^{\circ}C$
T_{stg}					-40 to 125				$^{\circ}C$
T_C									
T_J									
During soldering for 10 s maximum (terminal and case)					250				$^{\circ}C$

[†] In accordance with JEDEC registration data format (JES-22, RDF-1) filed for the JEDEC (2N series) types.
^Δ These values do not apply if there is a positive gate signal. Gate must be open or negatively biased.
[†] At maximum rated $I_{T(RMS)}$.
[♦] JEDEC registered value is 100 A at $T_C = 90^{\circ}C$.
[•] Any product of gate current and gate voltage which results in a gate power less than the maximum is permitted.
[■] JEDEC registered value is 10 W.
[■] For temperature measurement reference point, see Dimensional Outline.

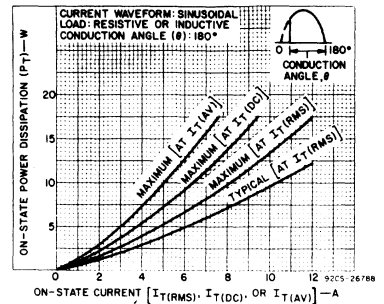


Fig. 1 - On-state power dissipation vs. on-state current for 2N6394-98, S6000 series.

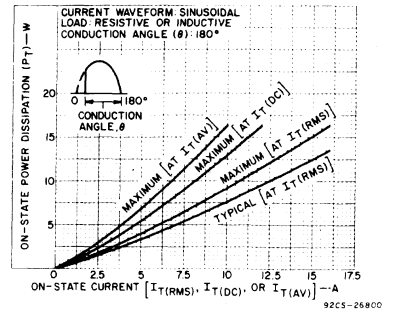


Fig. 2 - On-state power dissipation vs. on-state current for 2N6400-04, S6100 series.

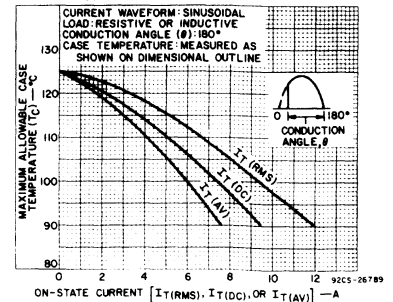


Fig. 3 - Maximum allowable case temperature vs. on-state current for 2N6394-98, S6000 series.

S6000 (2N6394-2N6398; S6000C, S6000E, S6000S) S6100 (2N6400-2N6404; S6100C, S6100E, S6100S) Series

ELECTRICAL CHARACTERISTICS, At Maximum Ratings Otherwise Specified and at Indicated Case Temperature (T_C)

CHARACTERISTIC	LIMITS			UNITS	
	For All Types				
	MIN.	TYP.	MAX.		
I_{DOM} or I_{ROM} $V_D = V_{DROM}$ or $V_R = V_{RROM}$, $T_C = 125^\circ\text{C}$	—	0.1	2*	mA	
v_T $i_T = 24$ A (peak), $T_C = 25^\circ\text{C}$ (12-A types) $i_T = 32$ A (peak), $T_C = 25^\circ\text{C}$ (16-A types)	(See Fig. 9, 10)	—	1.7 1.4	2.2* 1.7*	V
I_{HO} $T_C = 25^\circ\text{C}$ $T_C = -40^\circ\text{C}$	(See Fig. 11)	—	10	35 60*	mA
dv/dt $V_D = V_{DROM}$, exponential voltage rise, $T_C = 125^\circ$	50	—	—	—	V/ μs
I_{GT} $V_D = 12$ V (dc), $R_L = 50\Omega$, $T_C = 25^\circ\text{C}$ $V_D = 12$ V (dc), $R_L = 50\Omega$, $T_C = -40^\circ\text{C}$	(See Fig. 14)	—	8	30 60*	mA
V_{GT} $V_D = 12$ V (dc), $R_L = 50\Omega$, $T_C = 25^\circ\text{C}$ $V_D = 12$ V (dc), $R_L = 50\Omega$, $T_C = -40^\circ\text{C}$	(See Fig. 15)	—	0.7	1.5 2.5*	V
V_{GRD} $V_D = V_{DROM}$, $T_C = 125^\circ\text{C}$	0.2	—	—	—	V
t_{gt} $V_D = V_{DROM}$, $i_T = 24$ A (peak), $I_{GT} = 200$ mA, $t_r = 0.02\mu\text{s}$, $T_C = 25^\circ\text{C}$	—	—	—	2*	μs
t_{qi} Rectangular Pulse $V_D = V_{DROM}$, $i_T = I_T(\text{RMS})$, pulse duration = $50\mu\text{s}$, $dv/dt = 50$ V/ μs , $-di/dt = -10$ A/ μs , $I_{GT} = 80$ mA at turn-on, $V_R = 20$ V minimum, $V_{GK} = 0$ V at turn-off, $T_C = 75^\circ\text{C}$	—	35	75	—	μs
$R_{\theta JC}$	—	—	2*	—	$^\circ\text{C/W}$
$R_{\theta JA}$	—	—	50*	—	$^\circ\text{C/W}$

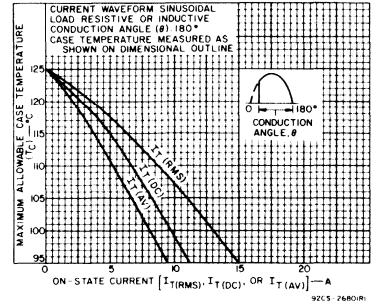


Fig. 4 — Maximum allowable case temperature vs. on-state current for 2N6400-04, S6100 series.

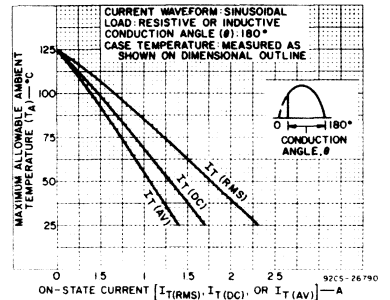


Fig. 5 — Maximum allowable ambient temperature vs. on-state current — no heat sinking for 2N6394-98, S6000 series.

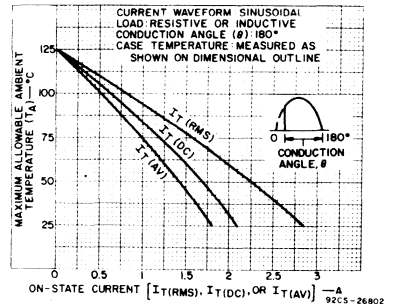


Fig. 6 — Maximum allowable ambient temperature vs. on-state current — no heat sinking for 2N6400-04, S6100 series.

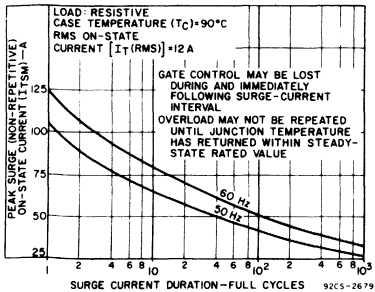


Fig. 7 — Allowable peak surge on-state current vs. surge duration for 2N6394-2N6398 and S6000 series.

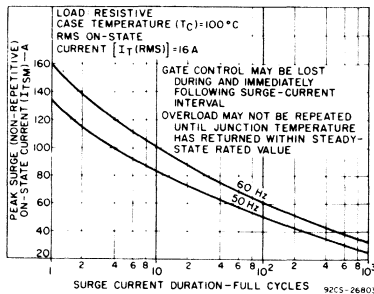


Fig. 8 — Allowable peak surge on-state current vs. surge duration for 2N6400-2N6404 and S6100 series.

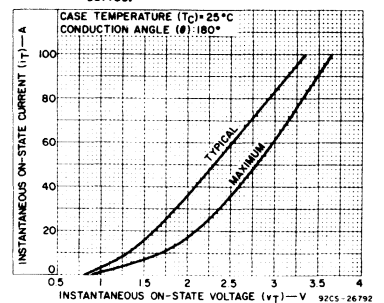


Fig. 9 — Instantaneous on-state current vs. instantaneous on-state voltage for 2N6394-2N6398 and S6000 series.

S6000 (2N6394-2N6398; S6000C, S6000E, S6000S)
S6100 (2N6400-2N6404; S6100C, S6100E, S6100S) Series

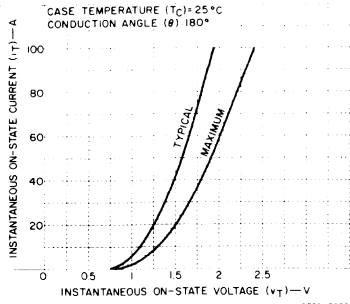


Fig. 10 — Instantaneous on-state current vs. instantaneous on-state voltage for 2N6400-2N6404 and S6100 series.

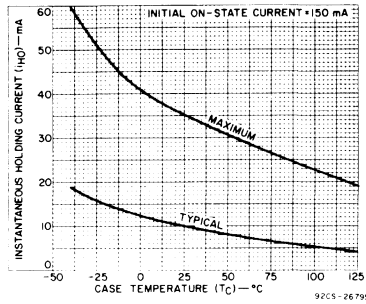


Fig. 11 — Instantaneous holding current vs. case temperature for all types.

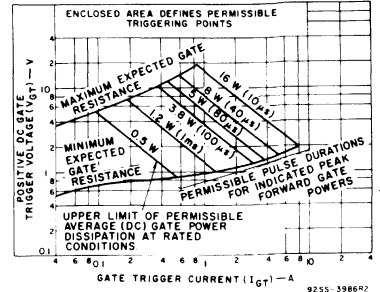


Fig. 12 — Gate trigger characteristics and limiting conditions for determination of permissible gate-trigger pulses for all types.

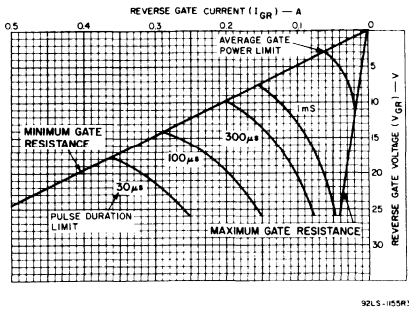


Fig. 13 — Reverse gate characteristics for all types.

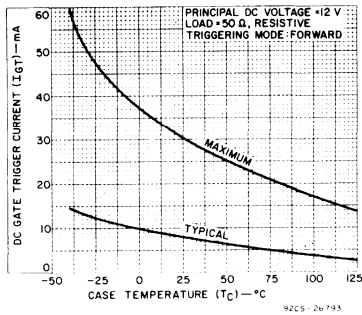


Fig. 14 — DC gate trigger current vs. case temperature for all types.

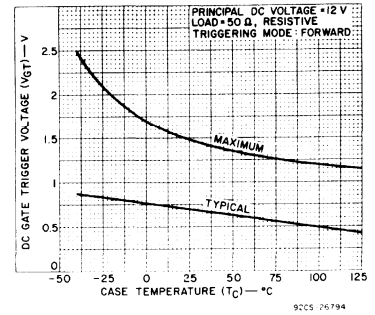


Fig. 15 — DC gate trigger voltage vs. case temperature for all types.

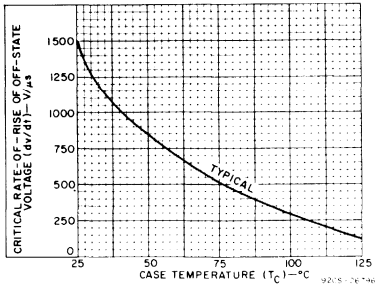


Fig. 16 — Critical rate of rise of off-state voltage vs. case temperature for all types.

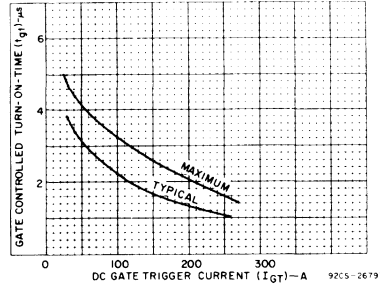


Fig. 17 — Typical gate-controlled turn-on time vs. gate trigger current for all types.

S6200, S6210, S6220 Series

20-A Silicon Controlled Rectifiers

Press-Fit, Stud, and Isolated-Stud Packages

These RCA types are all-diffused, silicon controlled rectifiers (revers-blocking triode thyristors) designed for power switching and voltage regulator applications and for heating, lighting and motor speed-control circuits.

These SCR's have an RMS on-state current rating (I_T [RMS])

of 20 A and have voltage ratings (V_{DROM}) of 100, 200, 400, and 600 volts.

The S6200 SCR series employs a hermetic press-fit package, the S6210 series employs a hermetic stud package, and the S6220 series employs a hermetic isolated-stud package.

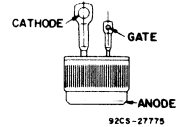
Features

- Low switching losses
- High di/dt and dv/dt capabilities
- Shorted-emitter gate-cathode construction
- Forward and reverse gate dissipation ratings
- All-diffused construction - assures exceptional uniformity and stability of characteristics
- Symmetrical gate-cathode construction - provides uniform current density, rapid electrical conduction, and efficient heat dissipation
- Low leakage currents, both forward and reverse
- Low forward voltage drop at high current levels
- Low thermal resistance

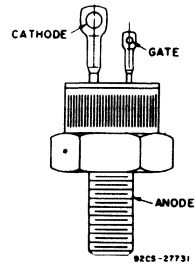
MAXIMUM RATINGS, Absolute-Maximum Values:

	S6200A S6210A S6220A	S6200B S6210B S6220B	S6200D S6210D S6220D	S6200M S6210M S6220M	
NON-REPETITIVE PEAK REVERSE VOLTAGE Gate Open	V_{RSOM}	150	250	500	700 V
NON-REPETITIVE PEAK FORWARD VOLTAGE Gate Open	V_{DSOM}	150	250	500	700 V
REPETITIVE PEAK REVERSE VOLTAGE Gate Open	V_{RROM}	100	200	400	600 V
REPETITIVE PEAK OFF-STATE VOLTAGE Gate Open	V_{DROM}	100	200	400	600 V
PEAK SURGE (NON-REPETITIVE) ON-STATE CURRENT: For one cycle of applied principal voltage $T_C = 75^\circ C$	I_{TSM}	170	200	See Fig. 3	
50-Hz. (sinusoidal)		170			A
60-Hz. (sinusoidal)		200			A
ON-STATE CURRENT: For case temperature (T_C) = $75^\circ C$, conduction angle of 180°	$I_{T(AV)}$	12.5			A
Average DC value		12.5			A
RMS value	$I_{T(RMS)}$	20			A
RATE-OF-CHANGE OF ON-STATE CURRENT: $V_{DM} = \sqrt{(BO)I_{GT}} = 200 \text{ mA}, t_r = 0.5 \mu s$	di/dt	200			A/ μs
FUSING CURRENT (for SCR protection): $T_J = -65 \text{ to } 100^\circ C, t = 1 \text{ to } 8.3 \text{ ms}$	I^2t	170			A ² s
GATE POWER DISSIPATION: PEAK FORWARD (for 10 μs max.)	P_{GCM}	40			W
AVERAGE (averaging time = 10 ms, max.)	$P_{G(AV)}$	0.5			W
PEAK REVERSE	P_{GRM}	See Fig. 10			
TEMPERATURE RANGE: Storage		-65 to 150			$^\circ C$
Operating (Case)		-65 to 100			$^\circ C$
Soldering (10 μs max. for terminals)		225			$^\circ C$

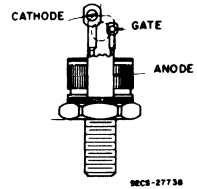
TERMINAL CONNECTIONS



Press-Fit Types



Stud Types



Isolated-Stud Types

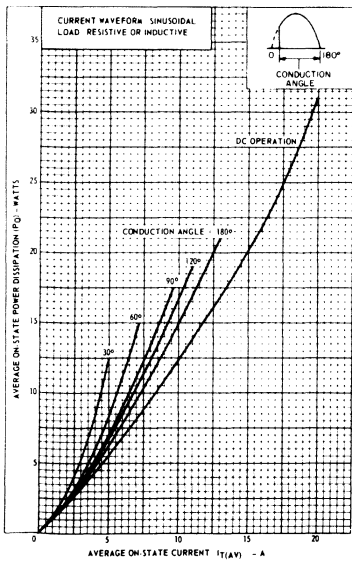


Fig. 1 - Power dissipation vs. on-state current.

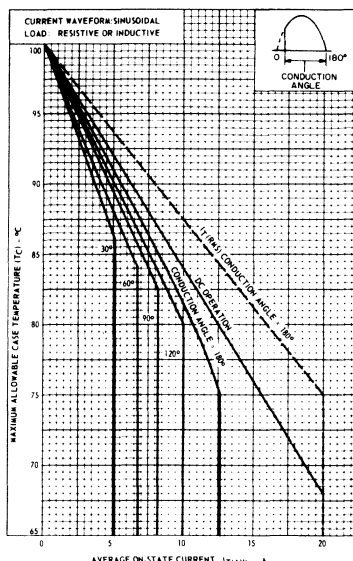


Fig. 2 - Maximum allowable case temperature vs. average forward current for stud and press-fit.

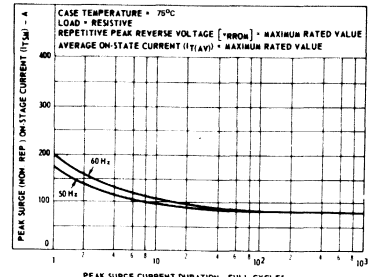


Fig. 3 - Peak surge on state current vs. surge current duration.

S6200, S6210, S6220 Series

ELECTRICAL CHARACTERISTICS

At Maximum Ratings and at Indicated Case Temperature (T_C) Unless Otherwise Specified

CHARACTERISTIC	SYMBOL	LIMITS - ALL TYPES			UNITS
		Min.	Typ.	Max.	
Instantaneous Forward Breakover Voltage: (Gate open, $T_C = 100^\circ\text{C}$)	V_{BO}	S6200A, S6210A, S6220A	100	-	V
S6200B, S6210B, S6220B		200	-		
S6200D, S6210D, S6220D		400	-		
S6200M, S6210M, S6220M		600	-		
Peak Off-State Current: (Gate open, $T_C = 100^\circ\text{C}$)	I_{DOM}	Forward: $V_{DO} = V_{DROM}$	-	0.2	mA
Reverse: $V_{RO} = V_{RROM}$		-	0.1	2	
Instantaneous On-State Voltage: For $I_T = 100\text{ A}$, $T_C = 25^\circ\text{C}$	V_T	-	1.9	2.4	V
DC Gate Trigger Current: $V_D = 12\text{ V (DC)}$, $R_L = 30\ \Omega$, $T_C = 25^\circ\text{C}$ At other case temperatures	I_{GT}	-	8	15	mA
DC Gate Trigger Voltage: $V_D = 12\text{ V (DC)}$, $R_L = 30\ \Omega$, $T_C = 25^\circ\text{C}$ At other case temperatures	V_{GT}	-	1.1	2	
Instantaneous Holding Current: Gate open, $T_C = 25^\circ\text{C}$ At other case temperatures	I_{HO}	-	9	20	mA
Critical Rate-of-Rise of Off-State Voltage: ($V_{DO} = V_{BO}$) Min. value. Exponential rise, $T_C 100^\circ\text{C}$)	dv/dt	10	100	-	
S6200A, S6200D, S6210A, S6210D, S6220A, S6220D	10	150	-		
S6200B, S6210B, S6220B	10	75	-		
Gate Controlled Turn-On Time: $V_D = V_{BO}$ Min. value, $I_T 30\text{ A}$, $I_{GT} 200\text{ mA}$, $0.1\ \mu\text{s}$ rise time, $T_C 25^\circ\text{C}$ See Fig. 11	t_{gt}	-	2	-	μs
Circuit Commutated Turn-Off Time: $V_D = V_{F(BO)}$ Min. value, $I_T 18\text{ A}$, Pulse Duration $50\ \mu\text{s}$, $dv/dt = 20\text{ V}/\mu\text{s}$, $di/dt = -30\text{ A}/\mu\text{s}$, $T_C = 75^\circ\text{C}$	t_q	-	20	40	μs
Thermal Resistance: Junction-to-Case (press-fit, stud packages)	$R_{\theta JC}$	-	-	1.2	$^\circ\text{C}/\text{W}$
Junction-to-Isolated Stud (Isolated-stud package)	$R_{\theta JS}$	-	-	1.4	

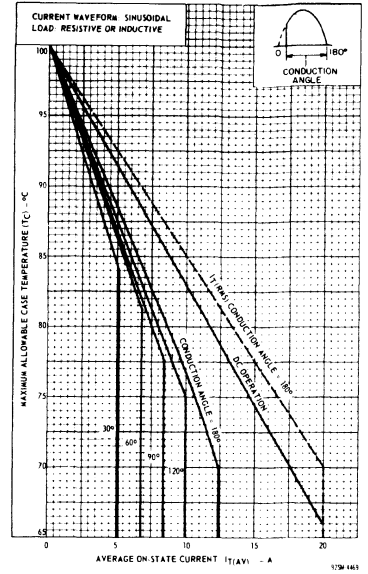


Fig. 4 - Maximum allowable case temperature vs. average forward current for isolated stud.

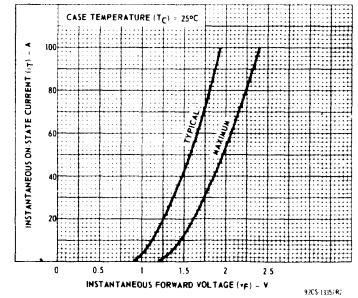


Fig. 5 - Instantaneous on-state current vs. on-state voltage.

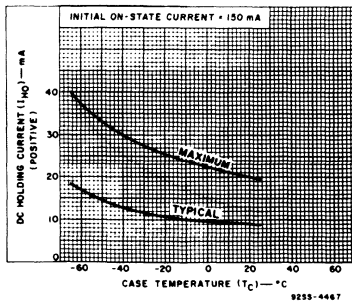


Fig. 6 - DC holding current vs. case temperature.

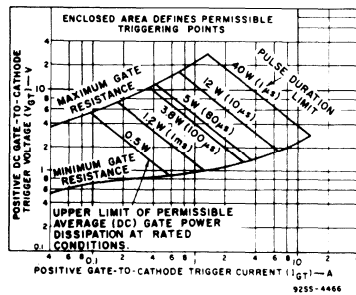


Fig. 7 - Typical forward-biased gate trigger characteristics.

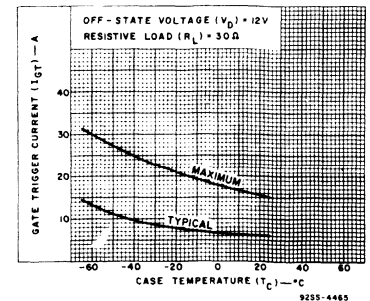


Fig. 8 - DC gate-trigger current (forward) vs. case temperature.

S6200, S6210, S6220 Series

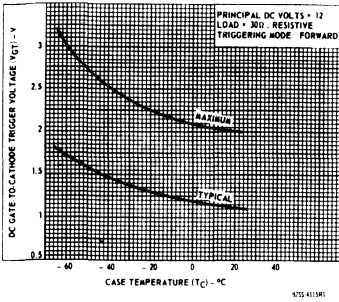


Fig. 9 - DC gate-trigger voltage vs. case temperature.

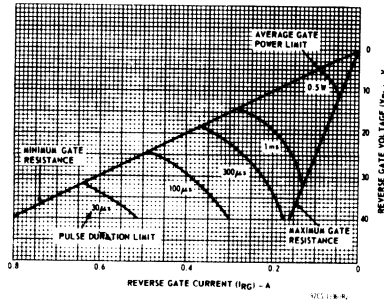


Fig. 10 - Reverse gate voltage vs. reverse gate current.

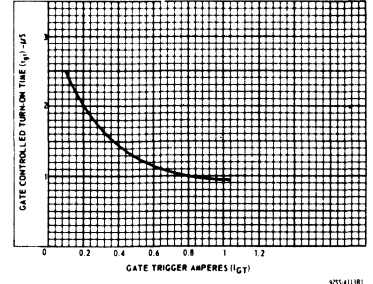


Fig. 11 - Gate controlled turn-on time (t_{gt}) vs. gate-trigger current.

WARNING: The ceramic of the isolated stud package contains beryllium oxide. Do not crush, grind, or abrade this part because the dust resulting from such action may be hazardous if inhaled. Disposal should be by burial.

S6230, S6240, S6250, S6430, S6440, S6450 Series

20- and 35-A Silicon Controlled Rectifiers

For General-Purpose Phase-Control Applications

These RCA silicon controlled rectifiers (reverse-blocking triode thyristors) are designed for general-purpose phase-control applications.

The S6230, S6240, and S6250 series have current ratings of 20 amperes. SCR's in each series have voltage ratings of 100, 200, 400, and 600 volts. The S6430, S6440, and S6450 series have current ratings of 35 amperes. SCR's in each series have voltage

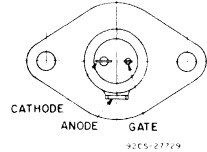
ratings of 100, 200, 400, 600, and 800 volts.

The S6230 and S6430 series employ a press-fit package with flexible leads, encapsulated on an isolated stud. The S6240 and S6440 series employ a press-fit package isolated on a TO-3 flange. The S6250 and S6450 series employ a press-fit package with flexible leads, encapsulated on an isolated TO-3 flange.

Features:

- 3-kV rms encapsulant (HYPOT) breakdown voltage
- Flame-resistant encapsulant (self-extinguishing)
- Rugged packages
- Standard RCA SCR features

TERMINAL CONNECTIONS



20-A SCR's — S6230, S6240, and S6250 Series
Electrical and Mechanical Data

Type No.	Rep. Peak Off-State Voltage V _{DROM} (V)	On-State Current I _T (RMS) (A)		Package (Press-fit)	Wire Size		Wire Insulation Thickness		Refer to Bulletin File No.*
		I _T (A)	T _C (°C)		Cathode Anode Gage No.	Gate Gage No.	Cathode Anode in. (mm)	Gate in. (mm)	
S6230A	100	20	70	With flex. leads, encap. on isolated-stud	14	22	0.031 (0.787)	0.016 (0.406)	418
S6230B	200								
S6230D	400								
S6230M	600								
S6240A	100	20	70	Isolated on TO-3 flange	-	-	-	-	418
S6240B	200								
S6240D	400								
S6240M	600								
S6250A	100	20	70	With flex. leads, encap., isolated on TO-3 flange	14	22	0.031 (0.787)	0.016 (0.406)	418
S6250B	200								
S6250D	400								
S6250M	600								

35-A SCR's — S6430, S6440, and S6450 Series
Electrical and Mechanical Data

S6430A	100	35	65	With flex. leads, encap. on isolated-stud	12	22	0.034 (0.863)	0.016 (0.406)	578
S6430B	200								
S6430D	400								
S6430M	600								
S6440A	100	35	65	Isolated on TO-3 flange	-	-	-	-	578
S6440B	200								
S6440D	400								
S6440M	600								
S6450A	100	35	65	With flex. leads, encap., isolated on TO-3 flange	12	22	0.034 (0.863)	0.016 (0.406)	578
S6450B	200								
S6450D	400								
S6450M	600								

* Electrical characteristics and ratings given in these bulletins also apply to the types listed in this chart.

S6240 S6440

FLEXIBLE-LEAD (TERMINAL) CONNECTIONS

Flexible-Lead (Insulation) Color Terminal
 White — Gate
 Red — Cathode
 Black — Anode

Note: Terminals are identified by color code only. Position of the flexible leads (relative to terminals of the device) leaving the encapsulant is random.

Press-Fit with Flexible Leads, Encapsulated on Isolated-Stud

S6230 S6430

Press-Fit with Flexible Leads, Encapsulated, Isolated on TO-3 Flange

S6250 S6450

WARNING: The ceramic used in these packages contains beryllium oxide. Do not crush, grind, or abrade these portions because the dust resulting from such action may be hazardous if inhaled. Disposal should be by burial.

S6400(2N3870-2N3873)S6410(2N3896-2N3899) S6420 Series¹

35-A Silicon Controlled Rectifiers

These RCA types are all-diffused, silicon controlled rectifiers (reverse-blocking triode thyristors) designed for power switching, power control, and voltage regulator applications and for heating, lighting, and motor speed-control circuits.

The 2N3870/73 and S6400N employ a hermetic press-fit package.

The 2N3896/99 and S6410N employ a hermetic stud package. The S6420 series employ a hermetic isolated-stud package.

MAXIMUM RATINGS, Absolute-Maximum Values:

*NON-REPETITIVE PEAK REVERSE VOLTAGE ^a Gate Open	V_{RSOM}	150	330	660	700	V
NON-REPETITIVE PEAK OFF-STATE VOLTAGE ^a Gate Open	V_{DSOM}	150	330	660	700	V
*REPETITIVE PEAK REVERSE VOLTAGE ^a Gate Open	V_{RROM}	100	200	400	600	V
*REPETITIVE PEAK OFF-STATE VOLTAGE ^a Gate Open	V_{DROM}	100	200	400	600	V
ON-STATE CURRENT: $T_C = 65^\circ\text{C}^+$, conduction angle = 180° :						
RMS	$I_T(\text{RMS})$	_____				A
Average	$I_T(\text{AV})$	_____				A
For other conditions		See Figs. 2 & 4				
PEAK SURGE (NON-REPETITIVE) ON-STATE CURRENT: For one full cycle of applied principal voltage, $T_C = 65^\circ\text{C}$						
60 Hz (sinusoidal)	I_{TSM}	_____				A
50 Hz (sinusoidal)		_____				A
For more than one full cycle of applied principal voltage		See Fig. 3				
RATE OF CHANGE OF ON-STATE CURRENT $V_D = V_{DROM}$, $I_{GT} = 200\text{ mA}$, $t_r = 0.5\ \mu\text{s}$	di/dt	_____				A/ μs
FUSING CURRENT (for SCR protection): $T_J = -40$ to 100°C , $t = 1$ to 8.3 ms	I^2t	_____				A ² s
GATE POWER DISSIPATION ^b Peak Forward (for $10\ \mu\text{s}$ max., See Fig. 7)	P_{GM}	_____				W
Peak Reverse	P_{PRGM}	_____				W
Average (averaging time = 10 ms max.)	$P_{G(AV)}$	_____				W
*TEMPERATURE RANGE ^c :						
Storage	T_{stg}	_____				$^\circ\text{C}$
Operating (Case)	T_C	_____				$^\circ\text{C}$
TERMINAL TEMPERATURE (During soldering): For 10 s max. (terminals and case)	T_T	_____				$^\circ\text{C}$

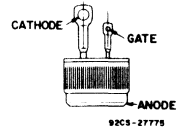
2N3870 2N3896 S6420A	2N3871 2N3897 S6420B	2N3872 2N3898 S6420C	2N3873 2N3899 S6420M	
150	330	660	700	V
150	330	660	700	V
100	200	400	600	V
100	200	400	600	V
		35		A
		22		A
		See Figs. 2 & 4		
		350		A
		300		A
		See Fig. 3		
		200		A/ μs
		300		A ² s
		40		W
		See Fig. 8		
		0.5		W
		-40 to 125		$^\circ\text{C}$
		-40 to 100		$^\circ\text{C}$
			225	$^\circ\text{C}$

^a In accordance with JEDEC registration data filed for the JEDEC (2N-series) types.
^b These values do not apply if there is a positive gate signal. Gate must be open or negatively biased.
^c $T_C = 65^\circ\text{C}$ for isolated-stud package types.
^d Any product of gate current and gate voltage which results in a gate power less than the maximum is permitted.
^e Temperature measurement point is shown on the DIMENSIONAL OUTLINE.

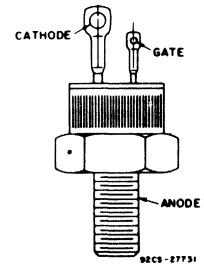
Features:

- High di/dt and dv/dt capabilities
- Low on-state voltage at high current levels
- Low thermal resistance
- Shorted-emitter center-gate construction

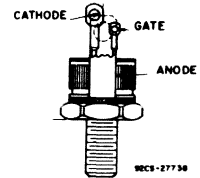
TERMINAL CONNECTIONS



Press-Fit Types



Stud Types



Isolated-Stud Types

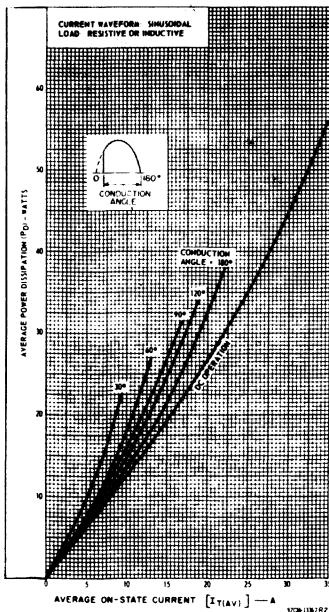


Fig. 1 — Power dissipation vs. on-state current.

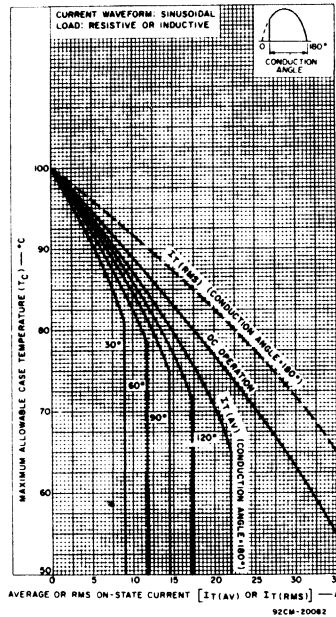


Fig. 2 — Maximum allowable case temperature vs. on-state current for press-fit and stud types.

WARNING: The ceramic of the isolated stud package contains beryllium oxide. Do not crush, grind, or abrade this part because the dust resulting from such action may be hazardous if inhaled. Disposal should be by burial.

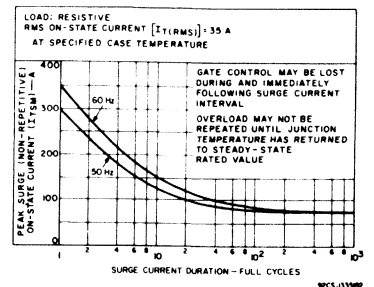


Fig. 3 — Peak surge on-state current vs. surge current duration.

S6400(2N3870-2N3873) S6410(2N3896-2N3899) S6420 Series

ELECTRICAL CHARACTERISTICS

At Maximum Ratings Unless Otherwise Specified and at Indicated Case Temperature (T_C)

CHARACTERISTIC	SYMBOL	LIMITS			UNITS
		FOR ALL TYPES Unless Otherwise Specified			
		MIN.	TYP.	MAX.	
Peak Off-State Current: (Gate open, $T_C = 100^\circ\text{C}$) Forward Current (I_{DOM}) at $V_D = V_{DROM}$ Reverse Current (I_{ROM}) at $V_R = V_{RROM}$ 2N3870, 2N3896, S6420A 2N3871, 2N3897, S6420B 2N3872, 2N3898, S6420D 2N3873, 2N3899, S6420M,	I_{DOM} or I_{ROM}	—	0.2 0.25 0.3	2* 2.5* 3*	mA
Instantaneous On-State Voltage: $i_T = 69\text{ A (peak), } T_C = 25^\circ\text{C}$ $i_T = 100\text{ A (peak), } T_C = 25^\circ\text{C}$	V_T	—	— 1.7	1.85* 2.1	V
DC Gate Trigger Voltage: $V_D = 12\text{ V (dc), } R_L = 30\ \Omega, T_C = -40^\circ\text{C}$ $V_D = 12\text{ V (dc), } R_L = 30\ \Omega, T_C = 25^\circ\text{C}$ For other case temperatures	V_{GT}	—	1.5 1.1	.3* 2	V
DC Gate Trigger Current: $V_D = 12\text{ V (dc), } R_L = 30\ \Omega, T_C = -40^\circ\text{C}$ $V_D = 12\text{ V (dc), } R_L = 30\ \Omega, T_C = 25^\circ\text{C}$ For other case temperatures	I_{GT}	— 1	46 25	80* 40	mA
Instantaneous Holding Current: Gate open, $T_C = 25^\circ\text{C}$ For other case temperatures	i_{HO}	0.5	3 <i>u</i>	70	mA
Gate Controlled Turn-On Time: (Delay Time + Rise Time) For $V_D = V_{DROM}, I_{GT} = 200\text{ mA}, t_r = 0.1\ \mu\text{s},$ $I_T = 30\text{ A (peak), } T_C = 25^\circ\text{C}$	t_{gt}	—	1.25	2	μs
Circuit Commutated Turn-Off Time: $V_D = V_{DROM}, i_T = 18\text{ A, pulse duration}$ $= 50\ \mu\text{s, } dv/dt = 20\text{ V}/\mu\text{s, } di/dt$ $= 30\text{ A}/\mu\text{s, } I_{GT} = 200\text{ mA, } T_C = 80^\circ\text{C}$	t_q	—	20	40	μs
Critical Rate of Rise of Off-State Voltage: $V_D = V_{DROM},$ exponential voltage rise, Gate open, $T_C = 100^\circ\text{C}$	dv/dt	10	100	—	V/ μs
Thermal Resistance, Junction-to-Case: Steady-State Press-fit & stud types Isolated-stud types	$R_{\theta JC}$	—	—	0.9* 1	$^\circ\text{C}/\text{W}$

*In accordance with JEDEC registration data filed for the JEDEC (2N-series) types.

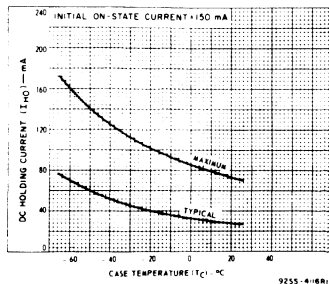


Fig. 6 — DC holding current vs. case temperature.

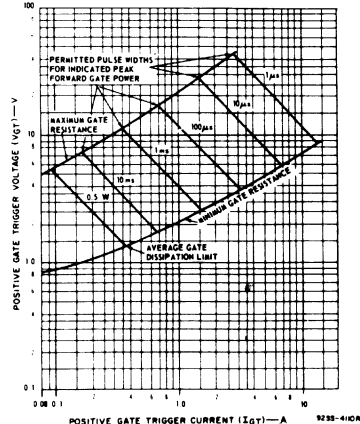


Fig. 7 — Gate pulse characteristics for forward triggering mode.

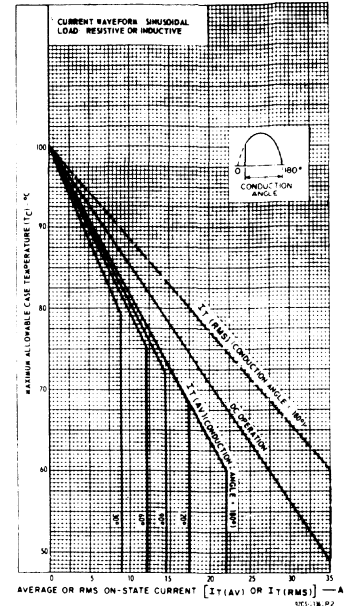


Fig. 4 — Maximum allowable case temperature vs. on-state current for isolated-stud types.

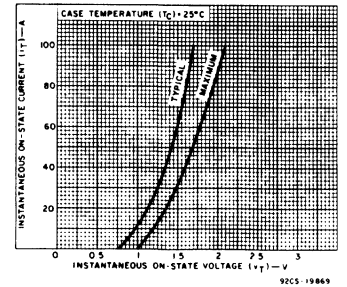


Fig. 5 — Instantaneous on-state current vs. on-state voltage.

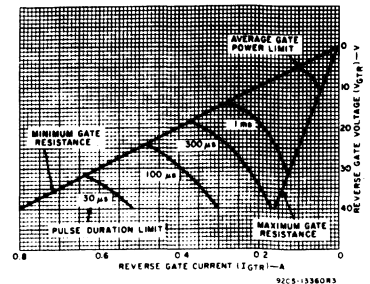


Fig. 8 — Reverse gate voltage vs. reverse gate current.

**S6400(2N3870-2N3873) S6410(2N3896-2N3899)
S6420 Series**

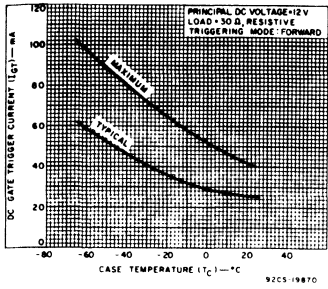


Fig.9 – DC gate trigger current (forward) vs. case temperature.

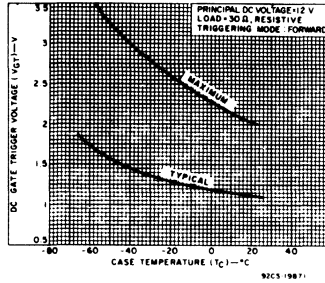


Fig.10 – DC gate trigger voltage (forward) vs. case temperature.

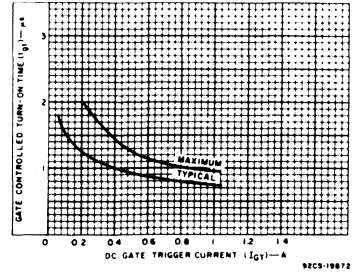


Fig.11 – Gate-controlled turn-on time vs. gate trigger current.

S6491 (2N681-2N690), S6492 (2N1842A-2N1850) Series

16-A and 25-A Silicon Controlled Rectifiers

For Power-Control and Power-Switching Applications

The RCA2N681-2N690 and the 2N1842A-2N1850A are all-diffused silicon controlled rectifiers (reverse-blocking triode thyristors) designed for switching ac and dc currents. These devices can switch from the off-state to the on-state when both

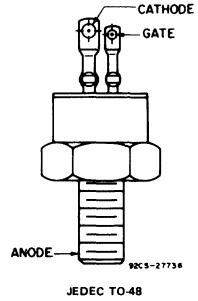
the anode and gate voltages are positive. Negative anode voltages make these devices revert to the blocking state.

These SCR's employ a hermetic JEDEC TO-48 package.

Features:

- High di/dt capability
- Low on-state voltage at high current levels
- Low thermal resistance
- Shorted-emitter center-gate construction

TERMINAL CONNECTIONS



MAXIMUM RATINGS, Absolute-Maximum Values:		2N681	2N682	2N683	2N684	2N685	2N686	2N687	2N688	2N689	2N690
		2N1842A	2N1845A	2N1844A	2N1845A	2N1846A	2N1847A	2N1848A	2N1849A	2N1850A	-
$V_{RS(ON)}^A$		35	75	150	225	300	350	400	500	600	700
V_{RM}^A		25	50	100	150	200	250	300	400	500	600
V_{DROM}^A		25	50	100	150	200	250	300	400	500	600
$I_T(RMS)$	($\theta = 180^\circ$):										
	$T_C = 80^\circ C$, (2N1842A-2N1850A)						16				A
	$T_C = 65^\circ C$, (2N681-2N690)						25				A
$I_T(AV)$	($\theta = 180^\circ$):										
	$T_C = 80^\circ C$ (2N1842A-2N1850A)						10				A
	$T_C = 65^\circ C$ (2N681-2N690)						16				A
I_{STM}^A	For one full cycle of applied principal voltage										
	60Hz \ddagger (2N1842A-2N1850A)						125				A
	60Hz \ddagger (2N681-2N690)						150				A
	50Hz \ddagger (2N1842A-2N1850A)						115				A
	50Hz \ddagger (2N681-2N690)						140				A
	For more than one full cycle of applied principal voltage										See Figs. 3, 4
di/dt											
$V_D = V_{DROM}$	$I_{GT} = 200$ mA,										
	$t_r = 0.5 \mu s$						200				A/ μs
$I^2 t$	(at T_C shown for $I_T(RMS)$):										
	$t = 10$ ms (2N1842A-2N1850A)						68				A $^2 s$
	(2N681-2N690)						100				A $^2 s$
	$t = 1$ ms (2N1842A-2N1850A)						32				A $^2 s$
	(2N681-2N690)						46				A $^2 s$
P_{GM}^A							5				W
$P_{GM(AV)}^A$							0.5				W
V_{GM}							2				A
V_{GRM}							10				V
I_{STG}^A	(2N1842A-2N1850A)						5				V
	(2N681-2N690)						-65 to 125				$^\circ C$
T_C							-65 to 150				$^\circ C$
T_J							-65 to 125				$^\circ C$
	During soldering for 10 s maximum (terminal and case)						225				$^\circ C$
T_J	Recommended						35				in-lb
	Maximum (DO NOT EXCEED)						0.4				kgf-m
							50				in-lb
							0.57				kgf-m

* In accordance with JEDEC registration data.
 † These values do not apply if there is a positive gate signal. Gate must be open or negatively biased.
 ‡ At $I_T(RMS) = 16$ A and $T_C = 80^\circ C$
 § At $I_T(RMS) = 25$ A and $T_C = 65^\circ C$
 ¶ Any product of gate current and gate voltage which results in a gate power less than the maximum is permitted.
 ■ For temperature measurement reference point, see Dimensional Outline.

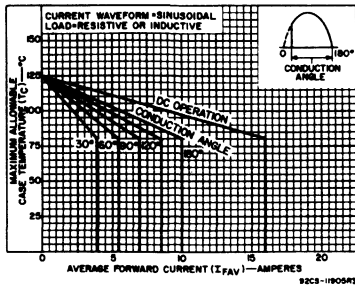


Fig. 2 - Maximum allowable case temperature vs. on-state current for 2N1842A-2N1850A.

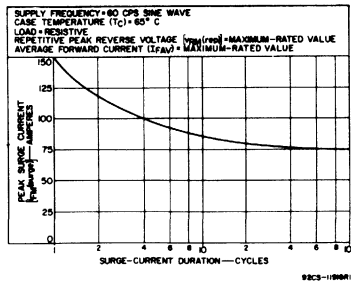


Fig. 3 - Peak surge on-state current vs. surge duration for 2N681-2N690.

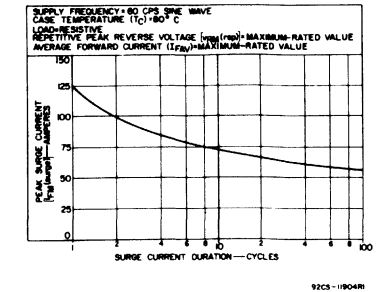


Fig. 4 - Peak surge on-state current vs. surge duration for 2N681-2N690.

S6491 (2N681-2N690), S6492 (2N1842A-2N1850) Series

ELECTRICAL CHARACTERISTICS, At Maximum Ratings Unless Otherwise Specified and at Indicated Case Temperature (T_C)

CHARACTERISTIC	LIMITS						UNITS
	2N681-2N690			2N1842A-2N1850A			
	MIN.	TYP.	MAX.	MIN.	TYP.	MAX.	
I_{DROM} or I_{RROM} : $V_D = V_{DROM}$ or $V_R = V_{RROM}$, $T_C = 125^\circ\text{C}$: 2N681, 2N682, 2N683, 2N684	-	-	6.5	-	-	-	mA
2N685	-	-	6	-	-	-	
2N686	-	-	5.5	-	-	-	
2N687	-	-	5	-	-	-	
2N688	-	-	4	-	-	-	
2N689	-	-	3	-	-	-	
2N690	-	-	2.5	-	-	-	
$V_D = V_{DROM}$ or V_{RROM} , $T_C = 80^\circ\text{C}$: 2N1842A	-	-	-	-	-	22.5	
2N1843A	-	-	-	-	-	19	
2N1844A	-	-	-	-	-	12.5	
2N1845A	-	-	-	-	-	6.5	
2N1846A	-	-	-	-	-	6	
2N1847A	-	-	-	-	-	5.5	
2N1848A	-	-	-	-	-	5	
2N1849A	-	-	-	-	-	4	
2N1850A	-	-	-	-	-	3	
v_T : $i_T = 30$ A (peak), $T_C = 25^\circ\text{C}$	-	-	-	-	-	2.5	V
$= 50$ A (peak), $T_C = 25^\circ\text{C}$	-	-	2	-	-	-	
$v_T(\text{AV})$: $I_T = I_T(\text{RMS})$, $T_C = 65^\circ\text{C}$	-	-	0.86	-	-	-	V
$= 80^\circ\text{C}$	-	-	-	-	-	1.2	
i_{HO} : $T_C = 125^\circ\text{C}$	-	15	-	-	8	-	mA
I_{GT} : $T_C = 125^\circ\text{C}$	-	-	25	-	-	4.5	mA
$V_D = 12$ V (dc), $R_L = 50\Omega$, $T_C = 25^\circ\text{C}$	-	-	80*	-	-	150*	
V_{GT} : $V_D = 12$ V (dc), $R_L = 50\Omega$, $T_C = -65$ to 125°C $= 125^\circ\text{C}$	-	-	3	-	-	-	V
$= -40^\circ\text{C}$	0.25	-	-	0.25	-	-	
$= -65^\circ\text{C}$	-	-	-	-	-	3.5	
$= 100^\circ\text{C}$	-	-	-	-	-	3.7	
$= 100^\circ\text{C}$	-	-	-	0.3	-	-	
$R_{\theta JC}$	-	-	2	-	-	2	$^\circ\text{C/W}$

*In accordance with JEDEC registration data.

▲ These values do not apply if there is a positive gate signal. Gate must be open or negatively biased.

● Any product of gate current and gate voltage which results in a gate power less than the maximum is permitted.

S6491 (2N681-2N690), S6492 (2N1842A-2N1850) Series

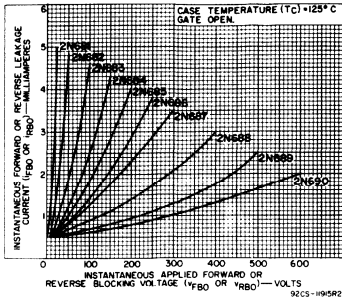


Fig. 5 - Typical peak off-state current or peak reverse current vs. off-state or reverse voltage for 2N681-2N690.

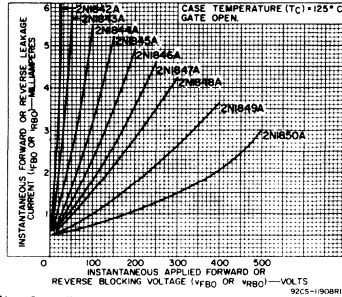


Fig. 6 - Typical peak off-state current or peak reverse current vs. off-state or reverse voltage for 2N1842A-2N1850A.

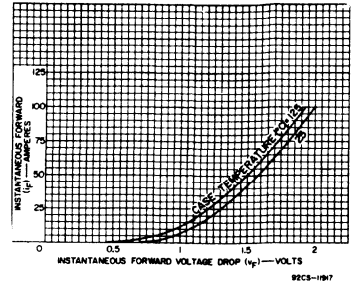


Fig. 7 - Typical on-state current vs. instantaneous on-state voltage for 2N681-2N690.

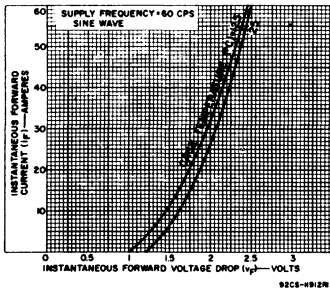


Fig. 8 - Typical on-state current vs. instantaneous on-state voltage for 2N1842A-2N1850A.

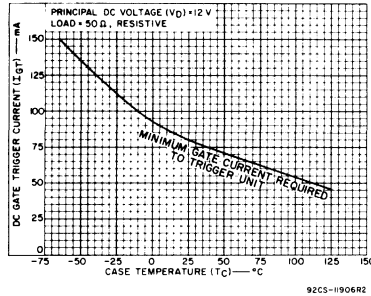


Fig. 9 - DC gate-trigger current vs. case temperature for 2N1842A-2N1850A.

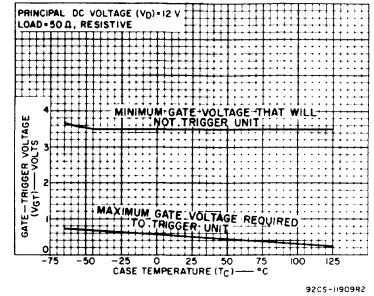


Fig. 10 - DC gate-trigger voltage vs. case temperature for 2N1842A-2N1850A.

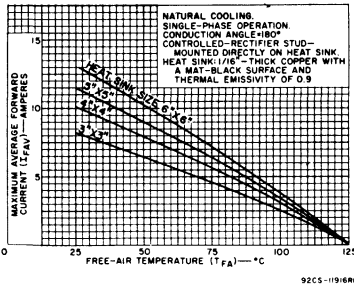


Fig. 11 - Average on-state forward current vs. ambient temperature for 2N681-2N690.

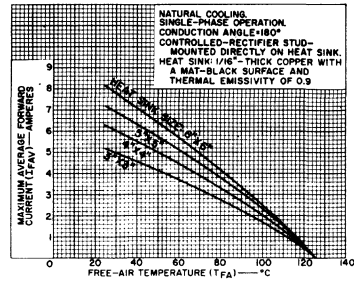


Fig. 12 - Average on-state forward current vs. ambient temperature for 2N1842A-2N1850A.

S6493M

Silicon Controlled Rectifier for High-Current Pulse Applications

The RCA-S6493M* is an all-diffused silicon controlled rectifier (reverse-blocking triode thyristor) designed especially for use in radar pulse modulators, inverters, switching regulators, and other applications requiring a large ratio of peak to average current. It is especially constructed for rapid spread of forward current over the full junction

area to achieve a high rate of change of forward current (di/dt) capability and low switching dissipation. The S6493M employs a hermetic JEDEC TO-48 package.

*Formerly RCA Type No. S6431M.

MAXIMUM RATINGS, Absolute-Maximum Values:

V_{RSOM}^{Δ}	700	V
V_{DSOM}^{Δ}	700	V
V_{RRM}^{Δ}	600	V
V_{DRM}^{Δ}	600	V
$I_T(RMS)$ ($T_C = 65^{\circ}C, \theta = 180^{\circ}$)	35	A
$I_{TM}(pulse)$ $T_C = 65^{\circ}C$. See Figs. 1 and 2	900	A
I_{CT} $T_J = -65$ to $125^{\circ}C, t = 1$ to 8.3 ms	2000	A 2 s
$P_D(AV)$ ($T_C = 65^{\circ}C$. See Fig. 3)	30	W
I_{GM}^{\bullet} Peak (forward or reverse) for $10 \mu s$ maximum, See Fig. 4	40	W
$P_G(AV)^{\bullet}$ Averaging time = 10 ms maximum	1	W
T_{stg}^{\blacksquare}	-65 to 150	$^{\circ}C$
T_C^{\blacksquare}	-65 to 125	$^{\circ}C$
T_T During soldering for 10 s maximum (terminals and case)	225	$^{\circ}C$
T_S Recommended	35 0.4 50 0.57	in-lbf kgf-m in-lbf kgf-m
Maximum (DO NOT EXCEED)		

- ▲ These values do not apply if there is a positive gate signal. Gate must be open or negatively biased.
- Any product of gate current and gate voltage which results in a gate power less than the maximum is permitted.
- For temperature measurement reference point, see Dimensional Outline.

ELECTRICAL CHARACTERISTICS

At Maximum Ratings Unless Otherwise Specified and at Indicated Case Temperature (T_C)

CHARACTERISTIC	LIMITS			UNITS
	MIN.	TYP.	MAX.	
I_{DOM} or I_{ROM} : $V_D = V_{DROM}$ or $V_R = V_{RRM}$. $T_C = 125^{\circ}C$	-	2	10	mA
$V_T(I)$ $I_{TM}(pulse) = 600$ A, $t = 2 \mu s$, $T_C = 65^{\circ}C$ (See Fig. 7)	-	-	19	V
I_{HO} : $T_C = 25^{\circ}C$	0.5	20	70	mA
dv/dt: $V_D = V_{DROM}$, exponential voltage rise, $T_C = 125^{\circ}C$	20	50	-	V/ μs
I_{GT} ($T_C = 25^{\circ}C$). See Fig. 4	1	25	80	mA
V_{GT} ($T_C = 25^{\circ}C$). See Fig. 4	-	1.1	2	V
t_{gt} : $V_D = V_{DROM}$, $I_T = 30$ A (peak), $I_{GT} = 200$ mA, $t_r = 0.1 \mu s$, $T_C = 25^{\circ}C$	-	1.25	-	μs
t_q : Rectangular Pulse $V_{DX} = V_{DROM}$, $I_T = 18$ A, pulse duration = $50 \mu s$, dv/dt = 20 V/ μs , - di/dt = -30 A/ μs , $I_{GT} = 200$ mA at turn-on, $T_C = 80^{\circ}C$	15	20	40	μs
$R_{\theta JC}$	-	-	2	$^{\circ}C/W$

Features:

- Up to 900 A peak pulse on-state current
- 30 W maximum average dissipation
- On-state current of 35 A (rms value)
- Shorted-emitter center-gate design

TERMINAL CONNECTIONS

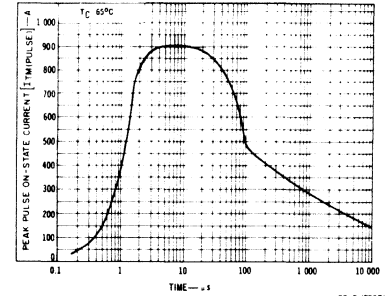
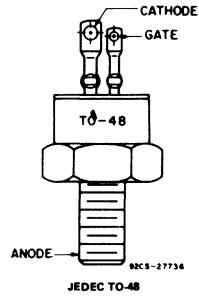


Fig. 1 — Peak pulse on-state current vs. time.

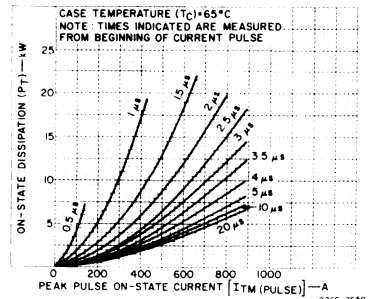


Fig. 2 — On-state dissipation vs. peak pulse on-state current and time.

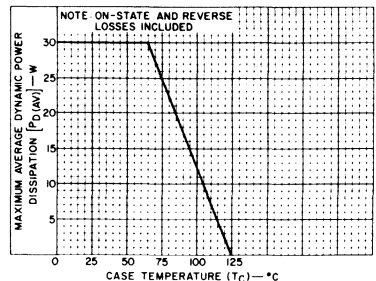


Fig. 3 — Dissipation derating curve.

S6493M

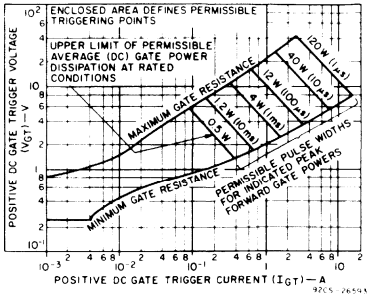


Fig. 4 - Forward-bias gate-trigger characteristics and limiting conditions for determination of permissible gate-trigger pulses.

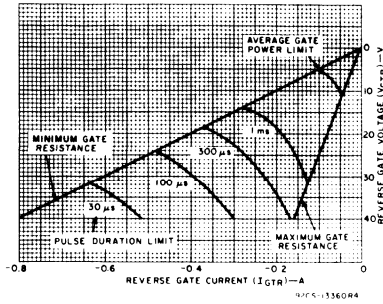


Fig. 5 - Reverse bias gate-trigger characteristics.

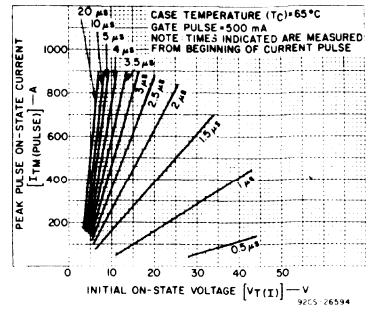


Fig. 6 - Initial on-state voltage characteristics.

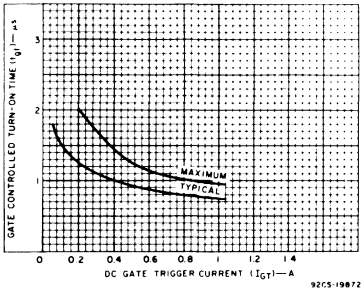


Fig. 7 - Gate-controlled turn-on time vs. gate trigger current.

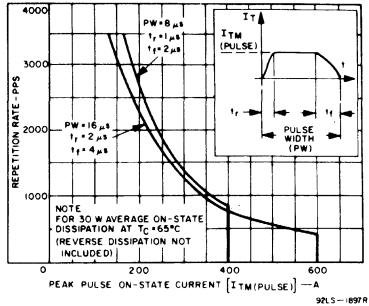


Fig. 8 - Peak pulse on-state current as a function of repetition rate, rectangular pulse.

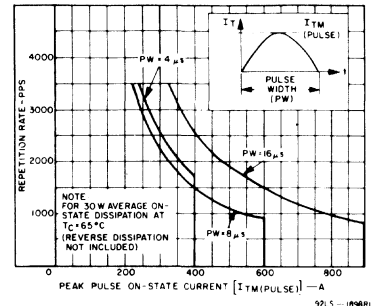


Fig. 9 - Peak pulse on-state current as a function of repetition rate, half sine wave pulse.

S7310 Series

40-A Asymmetrical Silicon Controlled Rectifiers (ASCR)

For Induction Cooking Appliances, Pulse Modulators, High-Frequency Inverters, Electronic Welders, and Other Switching Applications Up to 40 kHz

The RCA-S7310-series types are asymmetrical silicon controlled rectifiers designed for high-frequency power-switching applications such as induction-cooking-appliance controls, inverters, electronic welders, switching regu-

lators, and high-current pulse modulators. These types may be used at frequencies up to 40 kHz. They are supplied in the JEDEC TO-48 package.

MAXIMUM RATINGS, Absolute-Maximum Values:

	S7310B	S7310C	S7310D	S7310E	S7310M	
V_{RRM} ▲			7			V
V_{DRM} ▲	200	300	400	500	600	V
$I_T(RMS)$ ($T_C = 75^\circ C, \theta = 180^\circ$)			40			A
$I_T(AV)$ ($T_C = 75^\circ C, \theta = 180^\circ$)			25			A
I_{TSM}						
For one full cycle of applied principal voltage						
60-Hz (sinusoidal)			400			A
50-Hz (sinusoidal)			370			A
For more than one cycle of applied principal voltage			See Fig. 5			
di/dt						
$V_{DM} = V_{DRM}, I_{GT} = 500 \text{ mA}$						
$t_r = 0.5 \mu s$			2000			A/ μs
i^2T (at $T_C = 75^\circ C$)						
$t = 10 \text{ ms}$			700			A 2s
$t = 1 \text{ ms}$			325			A 2s
P_{GM} ●						
Peak forward for 10 μs max.			40			W
$P_G(AV)$ ●						
Averaging time = 10 ms maximum			2			W
T_{stg} ■			-40 to 150			$^\circ C$
T_C ■			-40 to 125			$^\circ C$
T_T						
During soldering for 10 s maximum (terminal and case)			225			$^\circ C$
T_S						
Recommended			35			in-lbf
			0.4			kgf-m
Maximum (DO NOT EXCEED)			50			in-lbf
			0.57			kgf-m

▲ These values do not apply if there is a positive gate signal. Gate must be open or negatively biased.
 ● Any product of gate current and gate voltage which results in a gate power less than the maximum is permitted.
 ■ For temperature measurement reference point, see Dimensional Outline.

Features:

- Fast turn-off-time-4 μs max.
- High di/dt and dv/dt capabilities
- Shorted-emitter gate-cathode construction . . . contains an internally diffused resistor between gate and cathode
- Low thermal resistance
- Center-gate construction . . . provides rapid uniform gate-current spreading for faster turn-on with substantially reduced heating effects

TERMINAL DESIGNATIONS

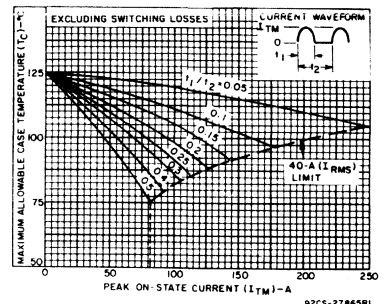
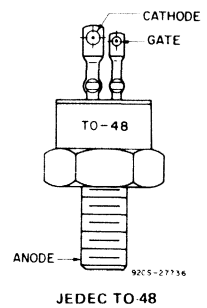


Fig. 1 - Maximum allowable case temperature vs. peak on-state current.

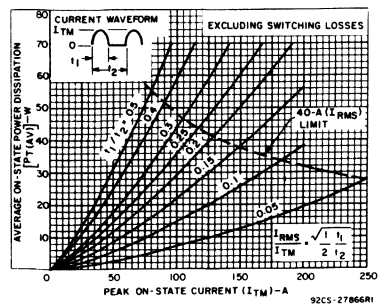


Fig. 2 - Average on-state power dissipation vs. peak on-state current.

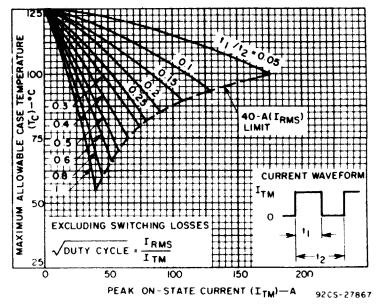


Fig. 3 - Maximum allowable case temperature vs. peak on-state current.

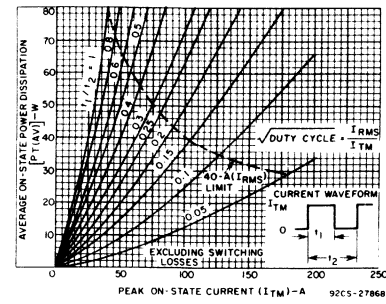


Fig. 4 - Average on-state power dissipation vs. peak on-state current.

S7310 Series

ELECTRICAL CHARACTERISTICS

As Maximum Ratings Unless Otherwise Specified and at Indicated Case Temperature (T_C)

CHARACTERISTIC	LIMITS			UNITS
	FOR ALL TYPES			
	Min.	Typ.	Max.	
I_{DROM} : $V_D = V_{DROM}$, $T_C = 125^\circ\text{C}$	—	—	4	mA
I_{RRROM} : $V_R = V_{RRROM}$, $T_C = 125^\circ\text{C}$	—	—	5	
V_T : $I_{TM} = 100\text{ A (peak)}$, $T_C = 25^\circ\text{C}$	—	1.7	2.5	V
$V_T(I)$: $I_{TM} = 100\text{ A (peak)}$, $I_{GT} = 0.5\text{ A}$, $t_r = 0.1\ \mu\text{s}$, $T_C = 25^\circ\text{C}$ (measured $0.5\ \mu\text{s}$ after 10% of I_{TM})	—	14	22	V
i_{HO} : $T_C = 25^\circ\text{C}$	10	35	110	mA
dv/dt : (Linear) $V_D = V_{DROM}$, $T_C = 125^\circ\text{C}$	250	550	—	V/ μs
I_{GT} : $V_D = 12\text{ V dc}$, $R_L = 30\ \Omega$, $T_C = 25^\circ\text{C}$	—	50	80	mA
V_{GT} : $V_D = 12\text{ V dc}$, $R_L = 30\ \Omega$, $T_C = 25^\circ\text{C}$	—	1	3	V
t_{gt} : $V_D = V_{DROM}$, $i_T = 100\text{ A (peak)}$, $I_{GT} = 500\text{ mA}$, $t_r = 0.1\ \mu\text{s}$, $T_C = 25^\circ\text{C}$, t_{gt}	—	250	290	ns
t_r	—	90	110	
t_d	—	160	180	
t_{q1} : 1/2 Sine Wave $V_D = V_{DROM}$, $i_T = 100\text{ A}$, pulse duration = $2\ \mu\text{s}$, $dv/dt = 200\text{ V}/\mu\text{s}$, $I_{GT} = 500\text{ mA}$ at turn-on, $V_{GK} = -10\text{ V}$ at turn-off, $T_C = 115^\circ\text{C}$	—	2.8	4	μs
R_{GK} (Reverse)	—	30	50	Ω
$R_{\theta JS}$	—	—	0.9	$^\circ\text{C}/\text{W}$

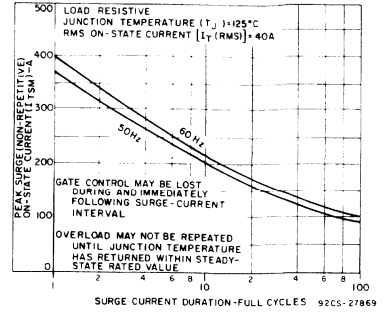


Fig. 5 – Peak surge on-state vs. surge duration.

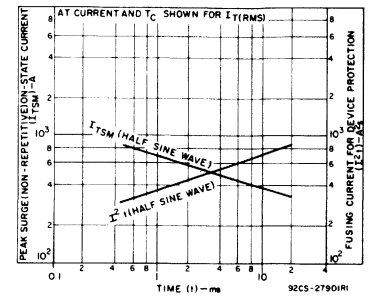


Fig. 6 – Peak surge on-state and fusing current vs. time.

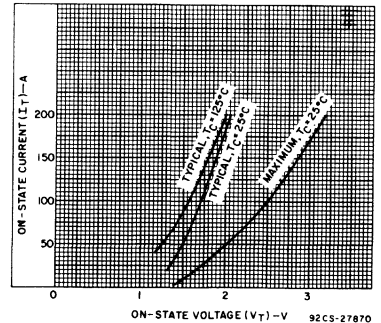


Fig. 7 – On-state current vs. on-state voltage.

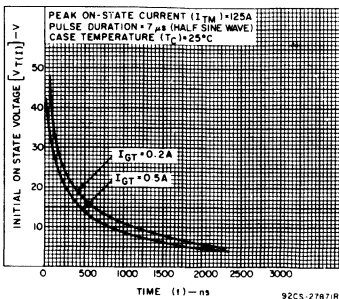


Fig. 8 – Typical initial on-state voltage vs. time. [Zero time is the time at which the initial on-state current is equal to $0.10I_{TM}$ (See Fig. 17)]

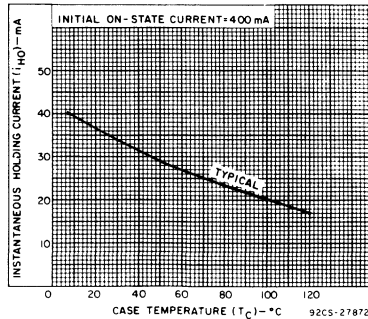


Fig. 9 – Typical instantaneous holding current vs. case temperature.

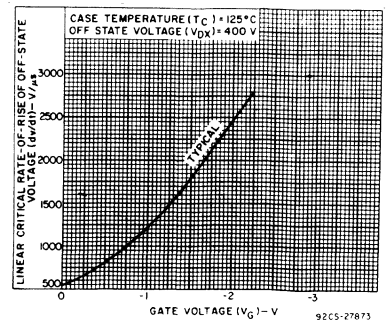


Fig. 10 – Typical linear critical rate of rise of off-state voltage vs. gate voltage.

S7310 Series

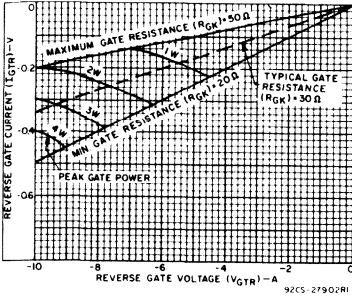


Fig. 11 - Reverse gate-trigger characteristics.

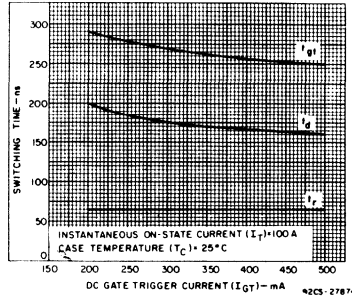


Fig. 12 - Typical switching time (t_{gt} , t_d , t_r) vs. gate-trigger current.

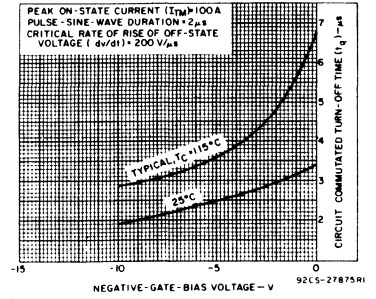


Fig. 13 - Typical circuit commutated turn-off time vs. gate-trigger voltage.

S7410 (2N3650-2N3653; S7410M) S7412 (2N3654-2N3658; S7412M) Series

35-A Silicon Controlled Rectifiers

For Inverter Applications

RCA-2N3650 to 2N3658, inclusive, and the S7410M* and S7412M* are all-diffused silicon controlled rectifiers (reverse-blocking triode thyristors) intended for high-speed switching applications such as power inverters, switching regulators, and high-current pulse applications. They feature fast turn-off, high dv/dt, and high di/dt characteristics and may be used at frequencies up to 25 kHz.

This SCR series has forward and reverse off-state voltage ratings of 50, 100, 200, 300, and 400 volts. Types S7410M and S7412M has a forward and reverse off-state voltage rating of 600 volts.

These SCR's employ a hermetic JEDEC TO-48 package.

* Formerly RCA Type No. S7432M.

* Formerly RCA Type No. S7430M.

MAXIMUM RATINGS, Absolute-Maximum Values:	2N3650	2N3651	2N3652	2N3653	S7410M		
	2N3654	2N3655	2N3656	2N3657	2N3658		S7412M
* V_{RSOM}^{Δ}	75	150	300	400	500	700	V
V_{DSOM}^{Δ}	75	150	300	400	500	700	V
* V_{RRM}^{Δ}	50	100	200	300	400	600	V
* V_{DRM}^{Δ}	50	100	200	300	400	600	V
$I_T(RMS)$ ($T_C = 40^{\circ}C, \theta = 180^{\circ}$)						35	A
* $I_T(AV)$ ($T_C = 40^{\circ}C, \theta = 180^{\circ}$)						25	A
* I_{TSM} : Peak rectangular pulse, $t_p = 5$ ms, $t_r = 50$ μ s max.						180	A
* di/dt: $V_D = V_{DROM}, I_{GT} = 200$ mA, $t_r = 0.1$ μ s						400	A/ μ s
I^2t : $T_J = -65$ to $120^{\circ}C, t = 1$ td 8.3 ms						165	A ² s
* P_{GM}^{Δ} : Peak (forward or reverse) for 10 μ s maximum, See Fig. 6)						40	W
* $P_{G(AV)}^{\Delta}$: Averaging time = 10 ms maximum						1	W
* T_{stg}^{Δ}						-65 to 150	$^{\circ}C$
* T_C^{Δ}						-65 to 120	$^{\circ}C$
T_T^{Δ} : During soldering for 10 s maximum (terminal and case)						225	$^{\circ}C$
T_s^{Δ} : Recommended						35	in-lbf
						0.4	kgf-m
						50	in-lbf
						0.57	kgf-m

- * In accordance with JEDEC registration data format (JS-14, RDF-1) filed for the JEDEC (2N series) types.
- Δ These values do not apply if there is a positive gate signal. Gate must be open or negatively biased.
- Any product of gate current and gate voltage which results in a gate power less than the maximum is permitted.
- For temperature measurement reference point, see Dimensional Outline.

Features

- Fast turn-off time – 10 μ s to 15 μ s max.
- High di/dt and dv/dt capabilities
- Shorted-emitter center gate design
- Low thermal resistance

TERMINAL CONNECTIONS

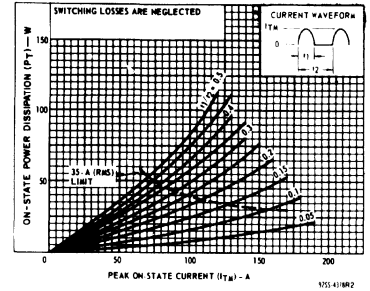
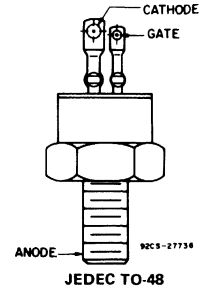


Fig. 1 - Maximum allowable case temperature as a function of on-state current.

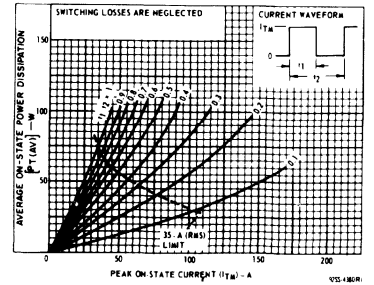


Fig. 2 - Maximum allowable case temperature as a function of on-state current.

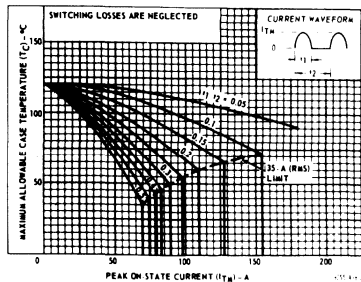


Fig. 3 - Peak surge on-state current as a function of surge duration.

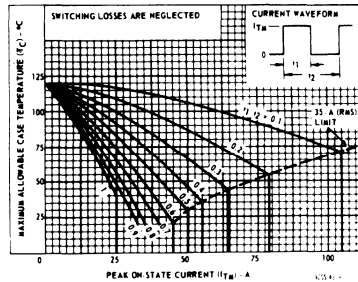


Fig. 4 - Peak surge on-state current as a function of surge duration.

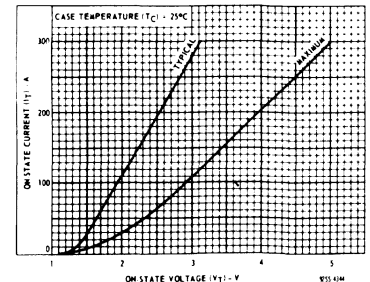


Fig. 5 - Maximum allowable case-temperature as a function of peak on-state current.

S7410 (2N3650-2N3653; S7410M) S7412 (2N3654-2N3658; S7412M) Series

ELECTRICAL CHARACTERISTICS

At Maximum Ratings Unless Otherwise Specified and at Indicated Case Temperature (T_C)

CHARACTERISTIC	LIMITS			UNITS
	FOR ALL TYPES Except as Specified			
	MIN.	TYP.	MAX.	
I_{DOM} or I_{ROM} : $V_D = V_{DROM}$ or $V_R = V_{RROM}$, $T_C = 120^\circ C$ 2N3654, 2N3655, 2N3656, S7412M 2N3657 2N3658	-	2	6*	mA
V_T : $I_T = 25$ A (peak), $T_C = 25^\circ C$	-	1.5	2.05*	V
I_{HO} : $T_C = 25^\circ C$ $T_C = -65^\circ C$	-	75	150	mA
dv/dt : $V_D = V_{DROM}$, exponential voltage rise, $T_C = 120^\circ C$	200	-	-	V/ μs
I_{GT} : $V_D = 6$ V (dc), $R_L = 4 \Omega$, $T_C = 25^\circ C$ $V_D = 6$ V (dc), $R_L = 2 \Omega$, $T_C = -65^\circ C$	-	80	180	mA
V_{GT} : $V_D = 6$ V (dc), $R_L = 4 \Omega$, $T_C = 25^\circ C$ $V_D = 6$ V (dc), $R_L = 200 \Omega$, $T_C = 120^\circ C$ $V_D = 6$ V (dc), $R_L = 2 \Omega$, $T_C = -65^\circ C$	0.25	-	3	V
t_q : Rectangular Pulse $V_{DX} = V_{DROM}$, $I_T = 10$ A, pulse duration = 50 μs , $dv/dt = 200$ V/ μs , $-di/dt = 5$ A/ μs , $I_{GT} = 200$ mA at turn-on, $V_{RX} = 15$ V minimum, $V_{GK} = 0$ V at turn-off, $T_C = 120^\circ C$ Sinusoidal Pulse $V_{DX} = V_{DROM}$, $I_T = 100$ A, pulse duration = 2 μs , $dv/dt = 200$ V/ μs , $V_{RX} = 30$ V minimum, $V_{GK} = 0$ at turn-off, $T_C = 115^\circ C$	-	-	15	μs
$R_{\theta JC}$	-	0.85	1.7*	$^\circ C/W$

* In accordance with JEDEC registration data format (JS-14, RDF-1) filed for the JEDEC (2N series) types.

- ▲ These values do not apply if there is a positive gate signal. Gate must be open or negatively biased.
- Any product of gate current and gate voltage which results in a gate power less than the maximum is permitted.
- For temperature measurement reference point, see Dimensional Outline.

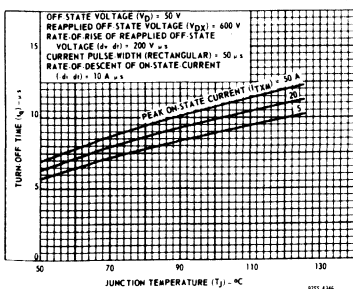


Fig.9 – Typical variation of turn-off time with junction temperature (rectangular pulse).

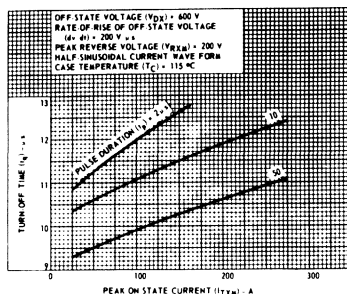


Fig.10 – Typical variation of turn-off time with peak on-state current (half-sine-wave pulse).

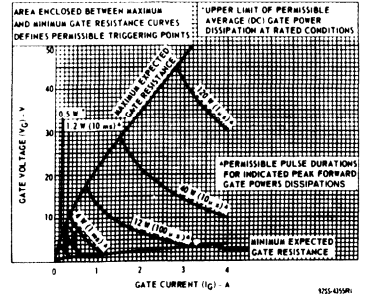


Fig.6 – Typical forward-biased gate characteristics.

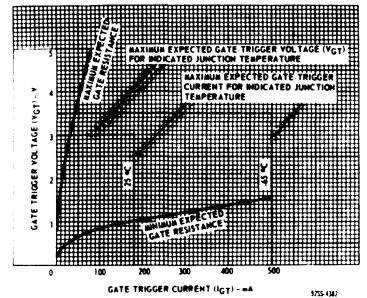


Fig.7 – Typical gate-trigger characteristics.

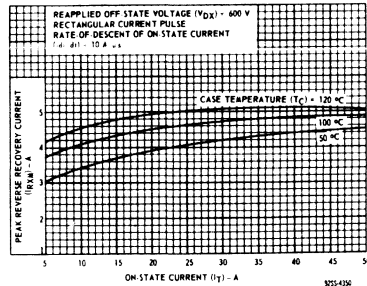


Fig.8 – Typical variation of peak reverse-recovery current with on-state current (rectangular pulse).

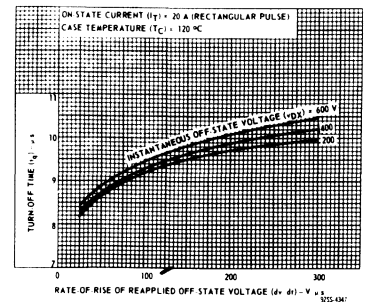


Fig.11 – Typical variation of turn-off time with rate-of-rise of reappplied off-state voltage (rectangular pulse).

S8610-S8613 Series, S8620-S8623 Series

75- and 100-A Silicon Controlled Rectifiers

For General-Purpose Phase-Control Applications

The RCA-S8610 through S8613 and S8620 through S8623 series of silicon controlled rectifiers (reverse-blocking triode thyristors) are designed for general-purpose phase-control applications, such as power switching and control and voltage regulators for heating, lighting, and motor speed control. Each series includes 100-, 200-, 400-, and 600-volt (V_{DROM} rating) SCR's.

SCR's in the S8610 through S8613 series are supplied in a stud package; SCR's in the S8620 through S8623 series are supplied in an isolated-stud package. These eight series of SCR's also offer a choice of on-state current ratings (100 or 75 amperes rms) and static dv/dt capabilities (1000 or 200 volts per microsecond).

Features:

- Stud and isolated-stud "overmolded" packages
- High peak-surge full-cycle current ratings
- Operating temperature range to 125°C
- High static dv/dt capability
- Shorted-emitter, center-gate design
- Low thermal resistance
- 2.5 kV rms isolation (isolated-stud types)

Maximum Ratings, Absolute-Maximum Values:

	Suffix Letter				V
	A	B	D	M	
V_{RSOM}^{Δ}	125	250	500	700	V
V_{DSOM}^{Δ}	125	250	500	700	V
V_{RROM}^{Δ}	100	200	400	600	V
V_{DROM}^{Δ}	100	200	400	600	V

ON-STATE CURRENT:

	$I_T(RMS)$	$I_T(AV)$	$I_T(DC)$	
	$\theta=180^{\circ}$	$\theta=180^{\circ}$		
Stud types, $T_C = 75^{\circ}C$				
S8610, S8611 series	100	63	70	A
S8612, S8613 series	75	47	63	A
Isolated-stud types, $T_C = 70^{\circ}C$				
S8620, S8621 series	100	63	70	A
S8622, S8623 series	75	47	63	A
I_{TSM}:				
For one cycle of applied principal voltage				
	60 Hz (sinusoidal)		50 Hz (sinusoidal)	
S8610, S8611 series, $T_C = 75^{\circ}C$	1000		850	A
S8620, S8621 series, $T_C = 70^{\circ}C$	1000		850	A
S8612, S8613 series, $T_C = 75^{\circ}C$	750		640	A
S8622, S8623 series, $T_C = 70^{\circ}C$	750		640	A

For more than one full cycle of applied principal voltage See Fig. 4

dI/dt : $V_D = V_{DROM}$, $I_{GT} = 200$ mA, $t_r = 0.1 \mu s$ 300 A/ μs

I^2t : [For Half-Sine Wave at T_C shown for $I_T(RMS)$]:
 $t = 10$ ms (S8610, S8611, S8620, S8621) 4400 A^2s
 (S8612, S8613, S8622, S8623) 2450 A^2s
 $t = 1$ ms (S8610, S8611, S8620, S8621) 2050 A^2s
 (S8612, S8613, S8622, S8623) 1150 A^2s

P_{GM}^{\bullet} : Peak (forward or reverse) for 10 μs maximum 40 W

$P_G(AV)^{\bullet}$: Averaging time = 10 ms maximum 1 W

T_{sto}^{\blacksquare} : -40 to 150 $^{\circ}C$
 T_C : -40 to 125 $^{\circ}C$

T_T : During soldering for 10 s maximum (terminals and case) 225 $^{\circ}C$

τ_s : Recommended 125 in-lb
 1.44 kgf-m
 Maximum (DO NOT EXCEED) 150 in-lb
 1.73 kgf-m

- ▲ These values do not apply if there is a positive gate signal. Gate must be open or negatively biased.
- Any product of gate current and gate voltage which results in a gate power less than the maximum is permitted.
- Temperature measurement point is shown on the DIMENSIONAL OUTLINE.

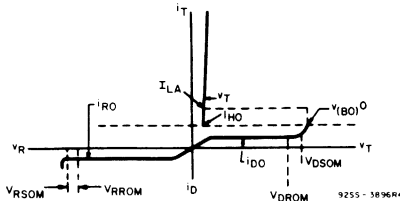
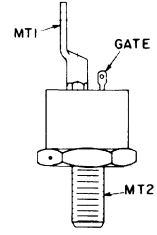


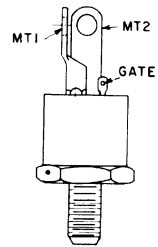
Fig. 1 - Principal voltage-current characteristic.

TERMINAL CONNECTIONS



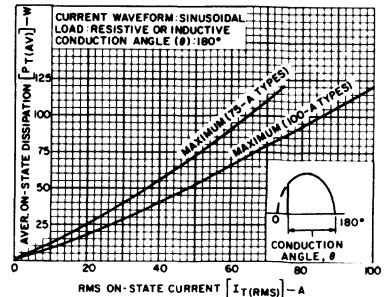
92CS-27733

**S8610 series
 S8611 series
 S8612 series
 S8613 series
 Stud "overmolded" types**



92CS-27739

**S8620 series
 S8621 series
 S8622 series
 S8623 series
 Isolated-stud "overmolded" types**



92CS-28607

Fig. 2 - Power dissipation vs. rms on-state current.

S8610-S8613 Series, S8620-S8623 Series

ELECTRICAL CHARACTERISTICS

At Maximum Ratings Unless Otherwise Specified and at Indicated Case Temperature (T_C)

CHARACTERISTIC	LIMITS			UNITS
	FOR ALL TYPES Except as Specified			
	MIN.	TYP.	MAX.	
I_{DOM} or I_{ROM} : $V_D = V_{DROM}$ or $V_R = V_{RROM}$, $T_C = 125^\circ\text{C}$	—	0.3	3	mA
v_T : $i_T = 200$ A (peak), $T_C = 25^\circ\text{C}$ (See Fig.6) S8610, S8611, S8620, S8621 series S8612, S8613, S8622, S8623 series	—	—	2.2 2.7	V
i_{HO} : $T_C = 25^\circ\text{C}$	—	100	200	mA
dv/dt : $V_D = V_{DROM}$, exponential voltage rise, $T_C = 125^\circ\text{C}$ S8610, S8612, S8620, S8622 series S8611, S8613, S8621, S8623 series	1000 200	1500 500	— —	V/ μs
I_{GT} : $V_D = 12$ V (dc), $R_L = 30 \Omega$, $T_C = 25^\circ\text{C}$, (See Fig.7) S8610, S8611, S8620, S8621 series S8612, S8613, S8622, S8623 series	25 —	100 35	200 200	mA
V_{GT} : $V_D = 12$ V (dc), $R_L = 30 \Omega$, $T_C = 25^\circ\text{C}$ (See Fig.8)	—	1.5	3	V
t_{gt} : $V_D = V_{DROM}$, $i_T = 200$ A (peak), $I_{GT} = 400$ mA, $t_r = 0.1 \mu\text{s}$, $T_C = 25^\circ\text{C}$	—	1.5	2.5	μs
t_q : $V_D = V_{DROM}$, $i_T = 50$ A, pulse duration = 50 μs , $dv/dt = 200$ V/ μs , $-di/dt = -5$ A/ μs , $I_{GT} = 200$ mA at turn-on, $V_{GK} = 0$ at turn-off, $T_C = 85^\circ\text{C}$	—	15	75	μs
$R_{\theta JS}$	—	—	0.4	$^\circ\text{C}/\text{W}$
$R_{\theta JIS}$	—	—	0.45	$^\circ\text{C}/\text{W}$

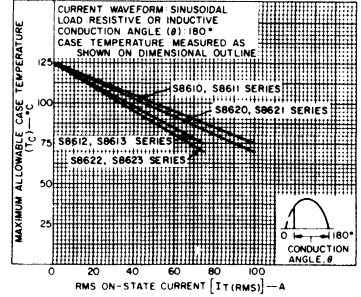


Fig.3 - Maximum allowable case temperature as a function of rms on-state current.

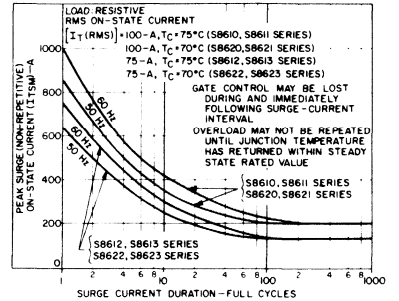


Fig.4 - Peak surge on-state current as a function of surge current duration.

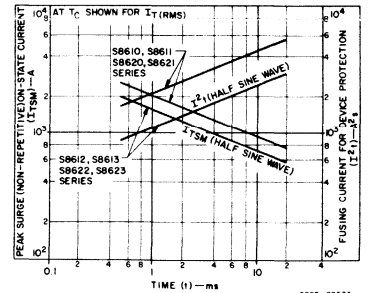


Fig.5 - Peak surge on-state current and fusing current as a function of time.

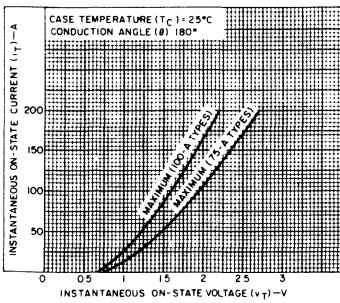


Fig.6 - Instantaneous on-state current vs. instantaneous on-state voltage.

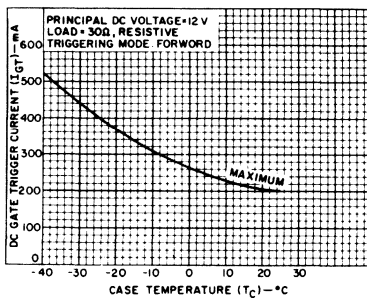


Fig.7 - Maximum dc gate trigger current vs. case temperature.

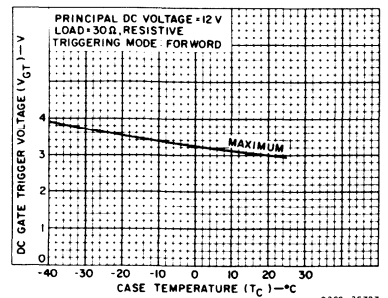


Fig.8 - Maximum dc gate trigger voltage vs. case temperature.

Gate-Turn-off (GTO) Silicon Controlled Rectifiers

Technical Data

G4000, G4001 Series Preliminary Data

5- and 10-A Gate-Turn-Off (GTO) Silicon Controlled Rectifiers

For Automotive and Other Power-Switching Applications

The RCA-G4000 and G4001 series devices are gate-turn-off silicon controlled rectifiers (GTO's). GTO devices employ the same basic four-layer, three-junction regenerative semiconductor structure and exhibit a pulse turn-on capability similar to that of conventional silicon controlled rectifiers (SCR's). GTO devices, however, differ from conventional SCR's in that they can be turned off by a short pulse of reverse gate current.

The G4000 and G4001 series gate-turn-off SCR's employ the JEDEC TO-220AB (RCA VERSAWATT) plastic package. The two series of devices differ in their gate-controlled turn-on and turn-off capabilities and peak reverse gate-voltage ratings. The types in each series differ in their off-state voltage ratings. The suffix letter indicates the voltage (V_{DRXM}) rating for each type.

Features:

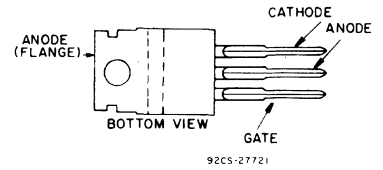
- Turn-off capability at gate terminal
- Operating temperature range to 125°C
- Glass-passivated junctions

MAXIMUM RATINGS, Absolute-Maximum Values:

	G4000A G4001A	G4000B G4001B	G4000D G4001D	
V_{RRM}	16	16	16	V
V_{DRXM}	100	200	400	V
V_{GRRM}	16	16	16	V
I_{TGQM} :				
G4000 Series		10		A
G4001 Series		5		A
I_T ($T_C = 80^\circ\text{C}$):				
G4000 Series		15		A
G4001 Series		12		A
I_{TSM} :				
For one full cycle of applied principal voltage, 60 Hz (sinusoidal), $T_C = 100^\circ\text{C}$:				
G4000 Series		85		A
G4001 Series		75		A
I_{GM} (10 μs)		3		A
I_{GRM} (20 μs max.):				
G4000 Series		10		A
G4001 Series		5		A
T_{stg}		-40 to 150		°C
T_C		-40 to 125		°C
T_L :				
At distance $\geq 1/32$ in. (0.8 mm) from seating plane for 10 s max.		250		°C

▲ For temperature measurement reference point, see Dimensional Outline.

TERMINAL CONNECTIONS



JEDEC TO-220AB

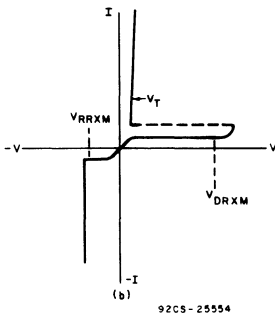


Fig. 1 — Anode-cathode voltage-current characteristic.

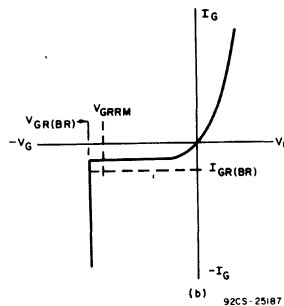


Fig. 2 — Gate-cathode voltage-current characteristic.

G4000, G4001 Series**ELECTRICAL CHARACTERISTICS,**At Maximum Ratings and $T_C = 25^\circ\text{C}$ Unless Otherwise Specified

CHARACTERISTIC	LIMITS			UNITS
	FOR ALL TYPES UNLESS OTHERWISE SPECIFIED			
	Min.	Typ.	Max.	
I_{DRXM} ($R_{GK} = 1000 \Omega$; $T_C = 125^\circ\text{C}$) $V_{DM} = V_{DRXM}$ $V_D = 30 \text{ V}$	–	–	5	mA
	–	–	100	μA
I_{RRM} : $V_R = 16 \text{ V}$, $T_C = 125^\circ\text{C}$	–	–	5	mA
I_{GRRM} : $V_{GR} = 16 \text{ V}$, $T_C = 125^\circ\text{C}$	–	–	5	mA
V_T ($T_C = 25^\circ\text{C}$): G4000 Series @ 10 A G4001 Series @ 5 A	–	–	103 102	V
I_{GT} ($V_D = 12 \text{ V}$, $R_L = 30 \Omega$): $T_C = 25^\circ\text{C}$ $T_C = -40^\circ\text{C}$	–	–	3 20	mA
V_{GT} ($V_D = 12 \text{ V}$, $R_L = 30 \Omega$): $T_C = 25^\circ\text{C}$ $T_C = -40^\circ\text{C}$	–	–	1 1.5	V
I_H ($V_D = 12 \text{ V}$, Gate open): $T_C = 25^\circ\text{C}$ $T_C = -40^\circ\text{C}$	–	10 50	–	mA
I_L ($V_D = 6 \text{ V}$, $I_{GT} = 20 \text{ mA}$): $T_C = 25^\circ\text{C}$ $T_C = -40^\circ\text{C}$	–	–	20 100	mA
dv/dt : $V_D = V_{DRXM}$, $I_{GT} = 0$, $R_{GK} = 1000 \Omega$, $T_C = 125^\circ\text{C}$	–	300	–	V/ μs
t_{gqk} (t_{OFF}): $I_T = I_{TGQM}$ $I_{GQM} = 0.6 I_T$ $V_{GG} < 0.2 \text{ V}$ @ $I_{GQ} = 300 \text{ mA}$ $T_C = 100^\circ\text{C}$			$T_{GQ} = 25$ $t_s = 5$ $t_f = 2$	μs
$R_{\theta JC}$ [▲]	–	–	2	$^\circ\text{C/W}$
$R_{\theta CA}$	–	–	50	$^\circ\text{C/W}$

▲ For temperature measurement reference point, see Dimensional Outline.

Diacs

Technical Data

D3202Y, D3202U

Silicon Bidirectional Diacs

Plastic-Packaged Two-Terminal Trigger Devices for Applications in Military, Industrial, and Commercial Equipment

Features:

- For critical triggering applications requiring narrow breakover voltage range (29-35V)—D3202Y
- Typical breakover voltage: $V(BO) = 32\text{ V}$
- Low breakover current (at breakover voltage): $I(BO) = 25\ \mu\text{A}$ max.
- High peak pulse current capability
- Breakover voltage symmetry:
 $|+V(BO)| - |-V(BO)| = \pm 3\text{ V max.}$

RCA D3202Y (45411)* and D3202U (45412)* are all-diffused, three-layer, two-terminal devices in an axial-lead plastic package designed specifically for triggering thyristors. Both units exhibit bidirectional negative-resistance characteristics.

These diacs are intended for use in thyristor phase-control circuits for lamp-dimming, universal-motor speed control, and heat controls. Their small size and plastic package of high insulation resistance make these diacs especially suitable for applications in which high packing densities are employed.

*Number in parentheses is a former RCA type number.

MAXIMUM RATINGS, Absolute-Maximum Values:

DEVICE DISSIPATION:
 At case temperature up to 40°C 1 W
 At case temperatures above 40°C Derate 0.016 W/°C

TEMPERATURE RANGE:
 Storage -40 to +150 °C
 Operating (Junction) -40 to +100 °C

LEAD TEMPERATURE (During Soldering)
 At distance $\geq 1/16$ in. (1.59 mm) from case for 10 s max. 240 °C

ELECTRICAL CHARACTERISTICS: At Case Temperature (T_C) = 25°C

CHARACTERISTIC	SYMBOL	TEST CONDITIONS	LIMITS				UNITS
			D3202Y		D3202U		
			MIN.	MAX.	MIN.	MAX.	
Breakover Voltage (Forward or Reverse)	$V(BO)$		29	35	25	40	V
Breakover Voltage Symmetry	$ +V(BO) - -V(BO) $		-	± 3	-	± 3	V
Peak Output Current	i_{pk}	$V_{SUPPLY} = 30\text{ VRMS}$, $C_T = 0.1\ \mu\text{F}$, $R_L = 20\ \Omega$	190	-	190	-	mA
Peak Breakover Current	$I(BO)$	At breakover voltage	-	25	-	25	μA
Dynamic Breakback Voltage	$ \Delta V \pm $	$V_{SUPPLY} = 30\text{ VRMS}$, $C_T = 0.1\ \mu\text{F}$, $R_L = 20\ \Omega$	9	-	9	-	V
Thermal Impedance Junction-to-ambient	θ_{JA}		-	60	-	60	°C/W

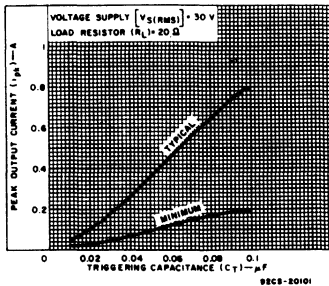


Fig. 1 — Peak output current vs. triggering capacitance.

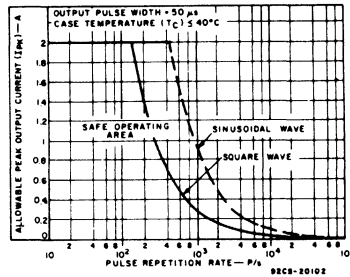


Fig. 2 — Peak output-current derating curves.

Silicon Rectifiers

Technical Data

General Purpose Rectifiers

RCA TYPE	Forward Current			Package	Voltage V _{RRM} V	Temp. Range Operating °C	Voltage Drop	
	Av. I _o A	Surge I _{FSM} A	Temp.-T _A °C				v _F V	I _o A

6-A TYPES

1N1341B	6	160	150	DO-4/ DO-203MA	50	-65 to 200	0.65	6
1N1342B	6	160	150		100	-65 to 200	0.65	6
1N1344B	6	160	150		200	-65 to 200	0.65	6
1N1345B	6	160	150		300	-65 to 200	0.65	6
1N1346B	6	160	150		400	-65 to 200	0.65	6
1N1347B	6	160	150		500	-65 to 200	0.65	6
1N1348B	6	160	150		600	-65 to 200	0.65	6

12-A TYPES

1N1199A	12	240	150	DO-4/ DO-203MA	50	-65 to 200	0.55	12
1N1200A	12	240	150		100	-65 to 200	0.55	12
1N1202A	12	240	150		200	-65 to 200	0.55	12
1N1203A	12	240	150		300	-65 to 200	0.55	12
1N1204A	12	240	150		400	-65 to 200	0.55	12
1N1205A	12	240	150		500	-65 to 200	0.55	12
1N1206A	12	240	150		600	-65 to 200	0.55	12

20-A TYPES

1N248C	20	350	150	DO-5/ DO-203MB	50	-65 to 175	0.6	20
1N249C	20	350	150		100	-65 to 175	0.6	20
1N250C	20	350	150		200	-65 to 175	0.6	20
1N1195A	20	350	150		300	-65 to 175	0.6	20
1N1196A	20	350	150		400	-65 to 175	0.6	20
1N1197A	20	350	150		500	-65 to 175	0.6	20
1N1198A	20	350	150		600	-65 to 175	0.6	20

40-A TYPES

1N1183A	40	800	150	DO-5/ DO-203MB	50	-65 to 200	0.65	40
1N1184A	40	800	150		100	-65 to 200	0.65	40
1N1186A	40	800	150		200	-65 to 200	0.65	40
1N1187A	40	800	150		300	-65 to 200	0.65	40
1N1188A	40	800	150		400	-65 to 200	0.65	40
1N1189A	40	800	150		500	-65 to 200	0.65	40
1N1190A	40	800	150		600	-65 to 200	0.65	40

■ At full cycle average

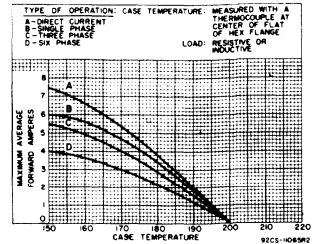


Fig. 1 -- Maximum average forward current vs. case temperature for 1N1341B, 1N1342B, 1N1344B-1N1348B.

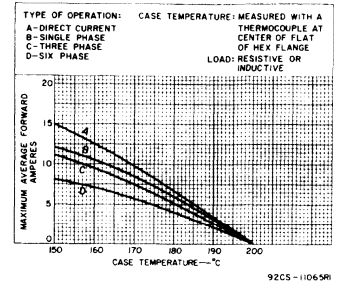


Fig. 2 -- Maximum average forward current vs. case temperature for 1N1199A, 1N1200A, 1N1202A-1N1206A.

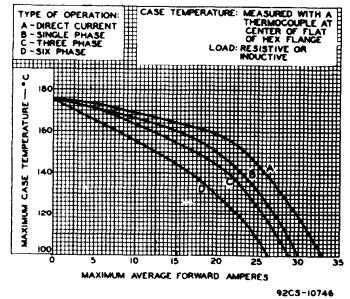


Fig. 3 -- Maximum average forward current vs. case temperature for 1N248C, 1N250C, 1N1195A-1198A.

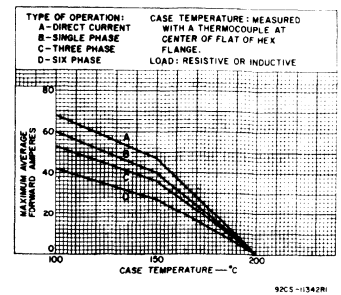


Fig. 4 -- Maximum average forward current vs. case temperature for 1N1183A, 1N1184A, 1N1186A-1N1190A.

Fast Recovery Rectifiers

RCA TYPE	Forward Current				Package	Voltage V _{RRM} V	Temp. Range Operating °C	Voltage Drop		Rev. Recovery Time		
	RMS I _F (RMS) A	Av. I _o A	Surge I _{FSM} A	Temp.-T _A °C				V _F V	i _F A	t _{rr} μs	I _{FM} A	T _C °C

9-A TYPES

D2406F	9	6	125	100	DO-4/ DO-203MA	50	-40 to 150	1.4	6	0.35	19	25
D2406A	9	6	125	100		100	-40 to 150	1.4	6	0.35	19	25
D2406B	9	6	125	100		200	-40 to 150	1.4	6	0.35	19	25
D2406C	9	6	125	100		300	-40 to 150	1.4	6	0.35	19	25
D2406D	9	6	125	100		400	-40 to 150	1.4	6	0.35	19	25
D2406M	9	6	125	100		600	-40 to 150	1.4	6	0.35	19	25
1N3879	9	6	75	100		50	-65 to 150	1.4	6	0.20	1	25
1N3880	9	6	75	100		100	-65 to 150	1.4	6	0.20	1	25
1N3881	9	6	75	100		200	-65 to 150	1.4	6	0.20	1	25
1N3882	9	6	75	100		300	-65 to 150	1.4	6	0.20	1	25
1N3883	9	6	75	100		400	-65 to 150	1.4	6	0.20	1	25

18-A TYPES

D2412F	18	12	250	100	DO-4/ DO-203MA	50	-40 to 150	1.4	12	0.35	38	25
D2412A	18	12	250	100		100	-40 to 150	1.4	12	0.35	38	25
D2412B	18	12	250	100		200	-40 to 150	1.4	12	0.35	38	25
D2412C	18	12	250	100		300	-40 to 150	1.4	12	0.35	38	35
D2412D	18	12	250	100		400	-40 to 150	1.4	12	0.35	38	25
D2412M	18	12	250	100		600	-40 to 150	1.4	12	0.35	38	25
1N3889	18	12	150	100		50	-65 to 150	1.4	12	0.20	1	25
1N3890	18	12	150	100		100	-65 to 150	1.4	12	0.20	1	25
1N3891	18	12	150	100		200	-65 to 150	1.4	12	0.20	1	25
1N3892	18	12	150	100		300	-65 to 150	1.4	12	0.20	1	25
1N3893	18	12	150	100		400	-65 to 150	1.4	12	0.20	1	25

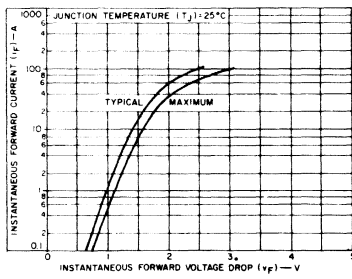


Fig. 5 - Forward current vs. forward voltage drop for D2406 series.

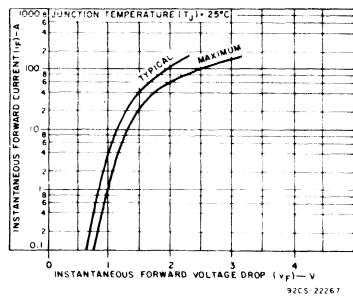


Fig. 6 - Forward current vs. forward voltage drop for D2412 series.

Fast Recovery Rectifiers

RCA TYPE	Forward Current				Package	Voltage V _{RRM} V	Temp. Range Operating °C	Voltage Drop		Rev. Recovery Time		
	RMS I _F (RMS) A	Av. I _o A	Surge I _{FSM} A	Temp.-T °C				v _F V	I _F A	t _{rr} μs	I _{FM} A	T _C °C

30-A TYPES

D2520F	30	20	300	100	DO-5/ DO-203MB	50	-40 to 150	1.4	20	0.35	63	25
D2520A	30	20	300	100		100	-40 to 150	1.4	20	0.35	63	25
D2520B	30	20	300	100		200	-40 to 150	1.4	20	0.35	63	25
D2520C	30	20	300	100		300	-40 to 150	1.4	20	0.35	63	25
D2520D	30	20	300	100		400	-40 to 150	1.4	20	0.35	63	25
D2520M	30	20	300	100		600	-40 to 150	1.4	20	0.35	63	25
1N3899	30	20	225	100		50	-65 to 150	1.4	20	0.20	1	25
1N3900	30	20	225	100		100	-65 to 150	1.4	20	0.20	1	25
1N3901	30	20	225	100		200	-65 to 150	1.4	20	0.20	1	25
1N3902	30	20	225	100		300	-65 to 150	1.4	20	0.20	1	25
1N3903	30	20	225	100	400	-65 to 150	1.4	20	0.20	1	25	

45-A TYPES

1N3909	45	30	300	100	DO-5/ DO-203MB	50	-65 to 150	1.4	30	0.20	1	25
1N3910	45	30	300	100		100	-65 to 150	1.4	30	0.20	1	25
1N3911	45	30	300	100		200	-65 to 150	1.4	30	0.20	1	25
1N3912	45	30	300	100		300	-65 to 150	1.4	30	0.20	1	25
1N3913	45	30	300	100		400	-65 to 150	1.4	30	0.20	1	25

60-A TYPES

D2540F	60	40	700	165	DO-5/ DO-203MB	50	-40 to 150	1.8	100	0.35	125	25
D2540A	60	40	700	165		100	-40 to 150	1.8	100	0.35	125	25
D2540B	60	40	700	165		200	-40 to 150	1.8	100	0.35	125	25
D2540D	60	40	700	165		400	-40 to 150	1.8	100	0.35	125	25
D2540M	60	40	700	165		600	-40 to 150	1.8	100	0.35	125	25

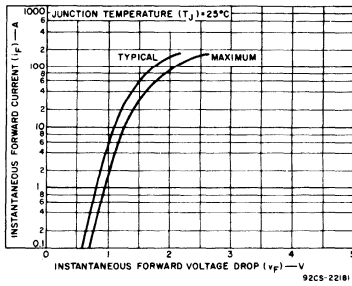


Fig. 7 - Forward current vs. forward voltage drop for D2520 series.

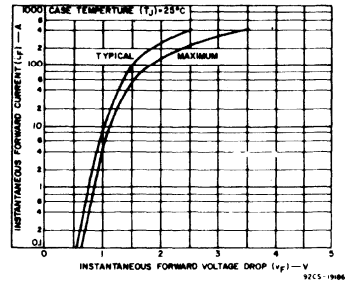


Fig. 8 - Forward current as a function of forward voltage drop for D2540 series.

High-Reliability Power Devices

Preconditioning and Screening

High-Reliability Power Devices

Solid-state devices classified as high-reliability types have come to be primarily associated with military and aerospace applications. In many ways, this association is misleading because the commercial equipment market is probably the largest user of high-reliability products, but not necessarily by that label. Military and aerospace agencies, however, have been largely responsible for establishment of comprehensive published reliability specifications and standards which have been accepted by the solid-state industry. MIL standards dominate the procedures used to specify high-reliability solid-state devices and represent a common reference point frequently used by commercial users to define their requirements.

Military and aerospace requirements for high-reliability solid-state devices are extremely large and diverse, not only in terms of performance, operating conditions, and reliability, but also in terms of logistics and procurement. As a result of these requirements, the military services have jointly developed specifications and standards under which most military end-use solid-state devices are procured. To simplify procurement, logistics, and the development of reliability data, MIL specs are not issued for the full spectrum of devices manufactured; rather, they are restricted to those devices for which significant need is demonstrated and are specified so that the device can have as wide applicability as possible. Although the limits for operating conditions may exceed those required for some applications, they simplify procurement and assure a supply of devices for the majority of military equipment. These standards also cover a wide range of requirements for the manufacturer on such things as:

- (a) The procedure and requirements for a manufacturer to become certified to manufacture MIL-spec parts.
- (b) The requirements for qualifying parts.
- (c) Product-assurance provisions in such areas as quality control, inspection procedures, personnel training, cleanliness, failure analysis, and documentation.
- (d) Test methods and procedures.
- (e) Marking and identification of product.
- (f) Preservation and packing.

100-per-cent screening (primarily burn-in) and a tight lot-sampling plan. Not all detailed specifications include JANTX requirements.

Fig. 1 shows the processing requirements specified by MIL-S-19500 for JAN and JANTX, solid-state power devices.

The Defense Electronic Supply Center maintains a "Qualified Products List" of all vendors qualified to produce devices in accordance with MIL-S-19500. This list is published periodically and is available to manufacturers of military equipment.

RCA offers a number of solid-state power devices that have been qualified as JAN, and JANTX, devices in accordance with MIL-S-19500.

Table I shows the wide product line of JAN, and JANTX, military-specification solid-state power devices available from RCA for high-reliability applications in military, aerospace, and critical industrial usage. These devices, which include power transistors, rf power transistors, and silicon controlled rectifiers (SCR's), are processed in accordance with the MIL-S-19500 general specifications. MIL-STD-750 test methods are used as required by the individual military detail specification. This table lists the individual MIL-S-19500 specification number for each family of devices.

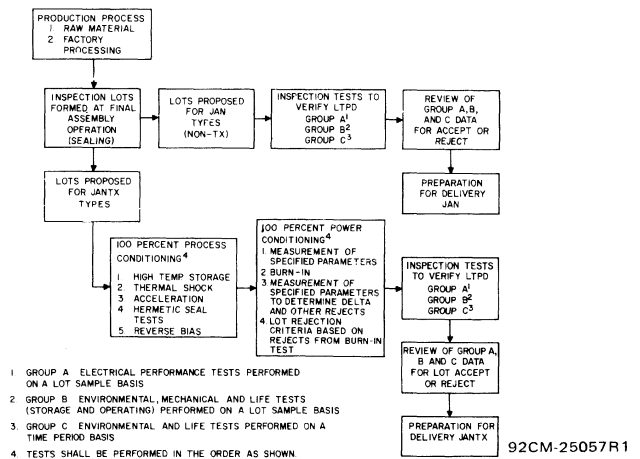


Fig. 1 — Order of procedure diagram for JAN and JANTX solid-state devices.

TABLE I — RCA JAN and JANTX Solid-State Power Devices

JAN, JANTX, SOLID-STATE DEVICES	Parent Type	Military Specification Type	MIL-S-19500/*
		POWER TRANSISTORS	
		Hometaxial-Base Types	
	2N1479	JAN2N1479	207
	2N1480	JAN2N1480	207
	2N1481	JAN2N1481	207
	2N1482	JAN2N1482	207
	2N1483	JAN2N1483, JANTX2N1483	180
	2N1484	JAN2N1484, JANTX2N1484	180
	2N1485	JAN2N1485, JANTX2N1485	180
	2N1486	JAN2N1486, JANTX2N1486	180
	2N1487	JAN2N1487	208
	2N1488	JAN2N1488	208
	2N1489	JAN2N1489	208
	2N1490	JAN2N1490	208
	2N3055	JAN2N3055, JANTX2N3055	407
	2N3441	JAN2N3441, JANTX2N3441	369
	2N3442	JAN2N3442	370
	2N3771	JAN2N3771, JANTX2N3771	413
	2N3772	JAN2N3772, JANTX2N3772	413

* MIL-S-19500 specifications can be obtained from the Naval Publications and Forms Center, 5801 Tabor Avenue, Philadelphia, Pa. 19120.

TABLE I - RCA JAN, JANTX, Solid-State Power Devices (cont'd)

Parent Type	Military Specification Type	MIL-S-19500*
POWER TRANSISTORS (Cont'd)		
High-Voltage Types		
2N3439	JAN2N3439, JANTX2N3439	368
2N3440	JAN2N3440, JANTX2N3440	368
2N3584	JAN2N3584, JANTX2N3584	384
2N3585	JAN2N3585, JANTX2N3585	384
2N5415	JAN2N5415, JANTX2N5415	485
2N5416	JAN2N5416, JANTX2N5416	485
2N5838	JAN2N5838, JANTX2N5838	487
2N5839	JAN2N5839, JANTX2N5839	487
2N5840	JAN2N5840, JANTX2N5840	487
2N6211	JAN2N6211, JANTX2N6211	461
2N6212	JAN2N6212, JANTX2N6212	461
2N6213	JAN2N6213, JANTX2N6213	461
2N6249	JAN2N6249, JANTX2N6249	510
2N6250	JAN2N6250, JANTX2N6250	510
2N6251	JAN2N6251, JANTX2N6251	510
2N6306	JAN2N6306, JANTX2N6306	498
2N6308	JAN2N6308, JANTX2N6308	498
2N6383	JAN2N6383, JANTX2N6383	523
2N6384	JAN2N6384, JANTX2N6384	523
2N6385	JAN2N6385, JANTX2N6385	523
2N6648	JAN2N6648, JANTX2N6648	527
2N6649	JAN2N6649, JANTX2N6649	527
2N6650	JAN2N6650, JANTX2N6650	527
High-Speed Types		
2N3879	JAN2N3879, JANTX2N3879	526
2N5038	JAN2N5038, JANTX2N5038	439
2N5039	JAN2N5039, JANTX2N5039	439
2N5671	JAN2N5671, JANTX2N5671	488
2N5672	JAN2N5672, JANTX2N5672	488
RF POWER TRANSISTORS		
2N2857	JAN2N2857, JANTX2N2857	343
2N3375	JAN2N3375, JANTX2N3375	341
2N3553	JAN2N3553, JANTX2N3553	341
2N4440	JAN2N4440, JANTX2N4440	341
2N3866	JAN2N3866, JANTX2N3866	398
2N5071	JAN2N5071, JANTX2N5071	442
2N5109	JAN2N5109, JANTX2N5109	453
SILICON CONTROLLED RECTIFIERS (SCR's)		
2N682	JAN2N682, JANTX2N682	108
2N683	JAN2N683, JANTX2N683	108
2N685	JAN2N685, JANTX2N685	108
2N687	JAN2N687, JANTX2N687	108
2N688	JAN2N688, JANTX2N688	108
2N690	JAN2N690, JANTX2N690	108
TRIACS		
2N5806	JAN2N5806	438
2N5807	JAN2N5807	438
2N5808	JAN2N5808	438
2N5809	JAN2N5809	438

* MIL-S-19500 specifications can be obtained from the Naval Publications and Forms Center, 5801 Tabor Avenue, Philadelphia, Pa. 19120.

Note: Ratings and characteristics data shown for the parent types earlier in this DATA BOOK are also applicable to the JAN and JANTX types.

TABLE II - LTPD sampling plans 1/ 2/ 3/

Minimum size of sample to be tested to assure, with a 90 percent confidence, that a lot having percent-defective equal to the specified LTPD will not be accepted (single sample).

Max. Percent Defective (LTPD) or λ	20	15	10	7	5	3	2	1.5	1	0.7	0.5	0.3
Acceptance Number (c) (r = c + 1)	Minimum Sample Sizes (For device-hours required for life test, multiply by 1000)											
0	11 (0.49)	15 (0.34)	22 (0.23)	32 (0.19)	45 (0.11)	76 (0.07)	116 (0.04)	153 (0.03)	231 (0.02)	328 (0.01)	461 (0.01)	787 (0.007)
1	18 (2.0)	25 (1.4)	38 (0.94)	55 (0.65)	77 (0.46)	129 (0.28)	195 (0.18)	258 (0.14)	390 (0.09)	555 (0.06)	778 (0.046)	1296 (0.027)
2	25 (3.4)	34 (2.24)	52 (1.6)	75 (1.1)	105 (0.78)	176 (0.47)	268 (0.31)	354 (0.23)	533 (0.15)	798 (0.11)	1085 (0.080)	1773 (0.045)
3	32 (4.4)	43 (3.2)	65 (2.1)	94 (1.5)	132 (1.0)	221 (0.62)	333 (0.41)	444 (0.31)	668 (0.20)	953 (0.14)	1337 (0.10)	2226 (0.062)
4	38 (5.3)	52 (3.9)	78 (2.6)	113 (1.8)	158 (1.3)	285 (0.75)	398 (0.50)	531 (0.37)	798 (0.25)	1140 (0.17)	1599 (0.12)	2683 (0.074)
5	45 (6.0)	60 (4.4)	91 (3.2)	131 (2.0)	184 (1.4)	308 (0.85)	462 (0.57)	617 (0.42)	927 (0.28)	1323 (0.20)	1855 (0.14)	3090 (0.085)
6	51 (6.8)	68 (4.9)	104 (3.2)	149 (2.2)	208 (1.6)	349 (0.94)	528 (0.62)	700 (0.47)	1054 (0.31)	1503 (0.22)	2107 (0.155)	3508 (0.093)
7	57 (7.2)	77 (5.3)	116 (3.6)	166 (2.4)	234 (1.7)	390 (1.0)	569 (0.51)	783 (0.51)	1178 (0.34)	1680 (0.24)	2358 (0.17)	3921 (0.101)
8	63 (7.7)	85 (5.6)	128 (3.7)	184 (2.6)	258 (1.8)	431 (1.1)	648 (0.54)	884 (0.54)	1300 (0.36)	1854 (0.25)	2599 (0.18)	4329 (0.108)
9	69 (8.1)	93 (6.0)	140 (3.9)	201 (2.7)	282 (1.9)	471 (1.2)	709 (0.58)	985 (0.58)	1421 (0.38)	2027 (0.27)	2842 (0.19)	4733 (0.114)
10	75 (8.4)	100 (6.3)	153 (4.1)	218 (2.9)	306 (2.0)	511 (1.7)	770 (0.80)	1085 (0.60)	1541 (0.40)	2189 (0.28)	3082 (0.20)	5133 (0.130)

1/ Sample sizes are based upon the Poisson exponential binomial limit.
 2/ The minimum quality (approximate AQL) required to accept (on the average) 19 of 20 lots is shown in parenthesis for information only.
 3/ This sampling plan is derived from Table C-1 in Appendix C of MIL-S-19500.

RCA NON-JAN TYPE SOLID-STATE DEVICES

Many solid-state devices are not covered by military specifications, either because they are too new or are not used in sufficient quantities. Many of these devices offer the most recent technological advances or have special performance characteristics which offer advantages to the designer of high-reliability equipment. RCA cooperates with the users of such devices in establishment of high-reliability specifications patterned after MIL standards, which allow these designs to be approved for use in military and aerospace systems, as well as commercial equipment. If the use warrants, these specifications may be submitted by RCA, or the user, to the cognizant military specification agency as candidates for MIL approval as a standard type.

Most procurements of solid-state devices for military systems are made by the equipment contractor from the MIL-STD parts list as awards are received for electronic equipment. Some military and aerospace programs, because of their size, duration, or special requirements (Minuteman and Apollo are two examples), require that special specifications and process methods, or even special production lines, be established and tailored to the particular functional, reliability, and economic needs of the program. RCA Solid State Division has frequently used the resources of its laboratories, production facilities, and expert technical staff to contribute to the success of such programs.

All RCA high-reliability solid-state power devices are processed in accordance with the provisions of MIL-S-19500. These provisions include the following items:

1. A clearly defined procedure for the conversion of a customer specification into an RCA internal specification with built-in safeguards to assure the customer that the delivered parts meet or exceed his specification requirements.
2. A formalized personnel training and testing program which assures that each operation is performed correctly.
3. A complete inspection of incoming materials, utilities, and work in process using on-site facilities such as scanning-electron-microscope and X-ray equipment.
4. Maintenance of cleanliness in work areas.
5. Rigorous control over changes in design, materials, and processes with documentation kept in active files for a minimum of three years.
6. Tool and test equipment maintenance and calibration in strict accordance with MIL-C-45662, "Calibration System Requirements."
7. A quality-assurance program in accordance with MIL-Q-9858, "Quality Program Requirements."

The Lot Sampling plans used for RCA high-reliability solid-state power devices, as defined by MIL-S-19500 and MIL-STD 105D, are shown in Tables II, III, and IV. Detailed processing and screening requirements for RCA high-reliability power transistors, thyristors (triacs and SCR's), and rf power transistors are described in the following paragraphs.

TABLE III – Sample Size Code Letters*

Lot or batch size		General inspection levels		
		I	II	III
2	to 8	A	A	B
9	to 15	A	B	C
16	to 25	B	C	D
26	to 50	C	D	E
51	to 90	C	E	F
91	to 150	D	F	G
151	to 280	E	G	H
281	to 500	F	H	J
501	to 1200	G	J	K
1201	to 3200	H	K	L
3201	to 10000	J	L	M
10001	to 35000	K	M	N
35001	to 150000	L	N	P
150001	to 500000	M	P	Q
500001	and over	N	Q	H

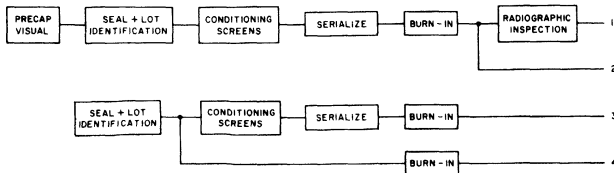
* Derived from Table I of MIL-STD-105D

TABLE IV – Single Sampling Plans for Normal Inspection*

Sample size code letter	Sample size	Acceptable Quality Levels (normal inspection)																																			
		0.010		0.015		0.025		0.040		0.065		0.10		0.15		0.25		0.40		0.65		1.0		1.5		2.5		4.0		6.5		10		15		25	
		Ac	Re	Ac	Re	Ac	Re	Ac	Re	Ac	Re	Ac	Re	Ac	Re	Ac	Re	Ac	Re	Ac	Re	Ac	Re	Ac	Re	Ac	Re	Ac	Re	Ac	Re	Ac	Re	Ac	Re		
A	2	↓	↓	↓	↓	↓	↓	↓	↓	↓	↓	↓	↓	↓	↓	↓	↓	↓	↓	↓	↓	↓	↓	↓	↓	↓	↓	↓	↓	↓	↓	↓	↓	↓	↓		
B	3	↓	↓	↓	↓	↓	↓	↓	↓	↓	↓	↓	↓	↓	↓	↓	↓	↓	↓	↓	↓	↓	↓	↓	↓	↓	↓	↓	↓	↓	↓	↓	↓	↓	↓		
C	5	↓	↓	↓	↓	↓	↓	↓	↓	↓	↓	↓	↓	↓	↓	↓	↓	↓	↓	↓	↓	↓	↓	↓	↓	↓	↓	↓	↓	↓	↓	↓	↓	↓	↓		
D	8	↓	↓	↓	↓	↓	↓	↓	↓	↓	↓	↓	↓	↓	↓	↓	↓	↓	↓	↓	↓	↓	↓	↓	↓	↓	↓	↓	↓	↓	↓	↓	↓	↓	↓		
E	13	↓	↓	↓	↓	↓	↓	↓	↓	↓	↓	↓	↓	↓	↓	↓	↓	↓	↓	↓	↓	↓	↓	↓	↓	↓	↓	↓	↓	↓	↓	↓	↓	↓	↓		
F	20	↓	↓	↓	↓	↓	↓	↓	↓	↓	↓	↓	↓	↓	↓	↓	↓	↓	↓	↓	↓	↓	↓	↓	↓	↓	↓	↓	↓	↓	↓	↓	↓	↓	↓		
G	32	↓	↓	↓	↓	↓	↓	↓	↓	↓	↓	↓	↓	↓	↓	↓	↓	↓	↓	↓	↓	↓	↓	↓	↓	↓	↓	↓	↓	↓	↓	↓	↓	↓	↓		
H	50	↓	↓	↓	↓	↓	↓	↓	↓	↓	↓	↓	↓	↓	↓	↓	↓	↓	↓	↓	↓	↓	↓	↓	↓	↓	↓	↓	↓	↓	↓	↓	↓	↓	↓		
J	80	↓	↓	↓	↓	↓	↓	↓	↓	↓	↓	↓	↓	↓	↓	↓	↓	↓	↓	↓	↓	↓	↓	↓	↓	↓	↓	↓	↓	↓	↓	↓	↓	↓	↓		
K	125	↓	↓	↓	↓	↓	↓	↓	↓	↓	↓	↓	↓	↓	↓	↓	↓	↓	↓	↓	↓	↓	↓	↓	↓	↓	↓	↓	↓	↓	↓	↓	↓	↓	↓		
L	200	↓	↓	↓	↓	↓	↓	↓	↓	↓	↓	↓	↓	↓	↓	↓	↓	↓	↓	↓	↓	↓	↓	↓	↓	↓	↓	↓	↓	↓	↓	↓	↓	↓	↓	↓	
M	315	↓	↓	↓	↓	↓	↓	↓	↓	↓	↓	↓	↓	↓	↓	↓	↓	↓	↓	↓	↓	↓	↓	↓	↓	↓	↓	↓	↓	↓	↓	↓	↓	↓	↓	↓	
N	500	↓	↓	↓	↓	↓	↓	↓	↓	↓	↓	↓	↓	↓	↓	↓	↓	↓	↓	↓	↓	↓	↓	↓	↓	↓	↓	↓	↓	↓	↓	↓	↓	↓	↓	↓	
P	800	↓	↓	↓	↓	↓	↓	↓	↓	↓	↓	↓	↓	↓	↓	↓	↓	↓	↓	↓	↓	↓	↓	↓	↓	↓	↓	↓	↓	↓	↓	↓	↓	↓	↓	↓	
Q	1250	↓	↓	↓	↓	↓	↓	↓	↓	↓	↓	↓	↓	↓	↓	↓	↓	↓	↓	↓	↓	↓	↓	↓	↓	↓	↓	↓	↓	↓	↓	↓	↓	↓	↓	↓	
R	2000	↓	↓	↓	↓	↓	↓	↓	↓	↓	↓	↓	↓	↓	↓	↓	↓	↓	↓	↓	↓	↓	↓	↓	↓	↓	↓	↓	↓	↓	↓	↓	↓	↓	↓	↓	

↓ = Use first sampling plan below arrow. If sample size equals or exceeds lot or batch size do 100 percent inspection. Ac = Acceptance number.
 ↑ = Use first sampling plan above arrow. Re = Rejection number.

* Derived from Table II-A of MIL-STD-105D



92CM-22891

Fig. 2 – Process-flow chart for four reliability levels of RCA high-reliability power transistors.

Power Transistors

In addition to JAN, JANTX, and JANTXV types, high-reliability selections of all RCA power transistors can be obtained on a custom basis. Such power transistors are subjected to high-reliability preconditioning and screening in accordance with the Group A, B, and C Sampling Tests as specified in MIL-STD-750 or special customer requirements. These power transistors can be supplied to four basic reliability levels. The preconditioning and screening for Level 1 is the same as that for JANTXV devices and, in addition, includes X-ray inspection. Level 2 corresponds directly to the JANTXV level. Level 3 devices are equivalent to JANTX devices. For RCA Level 4 devices, the preconditioning consists of burn-in only.

Fig. 2 shows the basic processing steps required for RCA high-reliability power transistors for each reliability level, and Table V lists the screening tests to which these devices are subjected. Tables VI, VII, and VIII list the Groups A, B, and C Sampling Tests and the test methods specified by MIL-STD-750.

Thyristors (Triacs and SCR's)

RCA high-reliability thyristors that are subjected to high-reliability preconditioning and screening in accordance with the Group A, B, and C Sampling Tests as specified in MIL-STD-750 or special customer requirements can be obtained on a custom basis. These thyristors can be supplied to four basic reliability levels that are approximately equivalent to, or exceed, the reliability classes (JAN, JANTX, JANTXV) defined by MIL-S-19500.

Fig. 3 shows the basic processing steps required for RCA high-reliability thyristors for each reliability level, and Table IX lists the screening tests to which these devices are subjected. Tables X, XI, and XII list the Groups A, B, and C Sampling Tests and the test methods specified by MIL-STD-750.

TABLE V – Screening Tests for RCA High-Reliability Power Transistors

Test	Conditions	MIL-STD-750		Screening Levels			
		Method	Conditions	1	2	3	4
1. Precap Visual		2072		X	X		
2. Seal and Lot Identification				X	X	X	X
3. High Temp Storage	24 hrs at 200°C			X	X	X	
4. Temperature Cycling	10 cycles	1051	C	X	X	X	
5. Acceleration	Y ₁ direction	2006		X	X	X	
6. Fine Leak		1071	G or H	X	X	X	
7. Gross Leak		1071	A,C,D or F	X	X	X	
8. Reverse Bias	24 hrs at 150°C	1039	A	X	X	X	
9. Serialize				X	X	X	
10. Pre Burn-in Electrical				X	X	X	
11. Burn-in	168 hrs at 25°C	1039	B	X	X	X	X
12. Post Burn-in Electrical				X	X	X	
13. Final Electrical				X	X	X	X
14. Radiographic Inspection		2076		X			
15. External Visual		2071		X	X	X	

Specific test conditions and limits determined by each type of transistor.

TABLE VI – Group A Inspections (power transistors)

Subgroup	Test	MIL-STD-750 Method
1	Visual & Mech Examination	2071
2	BVCEO, BVCEB, or BVCEX	3011
	ICEO, ICER, or ICES	3041
	IEBO	3061
3	IFE	3076
	VCE(10)	3071
	VBE	3066
4	IFE	3306
	Cobo	3236
	Ion	3251
	Ioff	3251
5	150°C ICES	3041
	-65°C IFE	3076

TABLE IX – Screening Test for High-Reliability Thyristors

Test	Condition	MIL-STD-750		Screening Levels			
		Method	Conditions	1	2	3	4
1. Precap visual	20 power			X			
2. Seal and lot identification				X	X	X	X
3. High-temperature Storage	24 hrs. at 150°C	1031		X	X		
4. Temperature cycling	Low temperature per device	1051	F	X	X		
5. Acceleration	Y ₁ direction	2006		X	X		
6. Hermeticity-fine leak		1071	H	X	X	X	
7. Hermeticity-gross leak		1071	D	X	X		
8. Serialize				X			
9. Preburn-in electrical-record				X			
10. Preburn-in electrical						X	X
11. Burn-in	24 to 168 hrs.; 100°C to 125°C			X	X	X	X
12. Post burn-in electrical						X	X
13. Post burn-in electrical-record Δ's				X		X	X
14. Final electrical				X	X		
15. Hermeticity-fine leak				X	X		
16. Hermeticity-gross leak				X			
17. Radiographic		2076		X			
18. External visual		2071		X			

TABLE VII – Group B Inspections (power transistors)

Subgroup	Test	MIL-STD-750 Method
1	Physical dimensions	2066
2	Solderability	2026
	Temperature Cycling	1051
	Moisture Resistance	1021
3	Shock	2018
	Vibration, Variable Frequency	2056
	Constant Acceleration	2066
4	Safe Operating Area	3051
5	High Temperature Life	1031
6	Steady-State Operation Life	1028

TABLE VIII – Group C Inspections (power transistors)

Subgroup	Test	MIL-STD-750 Method
1	Barometric Pressure	1001
2	Salt Atmosphere	1041

TABLE X – Group A Tests (triacs and SCR's)

Subgroup	Test	MIL-STD-750 Method
1	Visual	2071
2	Forward blocking current	4206.1
2	Reverse blocking current	4211.1
3	High-temp. forward blocking current	
3	High-temp. reverse blocking current	
3	High-temp. gate-trigger voltage or gate-trigger current	4221.1
3	Exponential rate of voltage rise	4231.2
4	Gate-trigger voltage or gate-trigger current at 25°C	
4	Gate-controlled turn-on time	4223
4	Circuit-commutated turn-off time	4224
4	Gate-controlled turn-off time	4225
4	Forward "on" voltage	4226.1
4	Holding current	4201.2

TABLE XI – Group B Tests (triacs and SCR's)

Test	MIL-STD-750 Method
Reverse gate current	4219
Surge current	4066
Temperature cycling	1051
Thermal shock (glass strain)	1056
Terminal strength	2036
Moisture resistance	1021
AC blocking voltage	-

TABLE XII – Group C Tests (triacs and SCR's)

Subgroup	Test	MIL-STD-750 Method
1	Physical dimensions	2066
	Shock	2016
2	Vibration, variable-frequency	2056
2	Constant acceleration	2066
3	Barometric pressure	1001
4	Salt atmosphere	1041
5	Solderability	2026
6	Intermittent life	

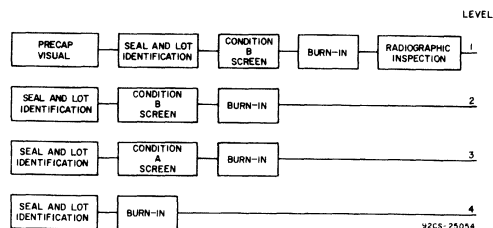


Fig. 3 – Basic processing and screening required for RCA high-reliability triacs and SCR's.

Appendix

	Page
General Characteristics, Test Circuits, Waveforms	586
Dimensional Outlines	595
Suggested Mounting Hardware	603
Lead Forms for RCA Plastic Power Packages	606
Handling and Mounting of RCA Molded-Plastic Transistors and Thyristors (AN-4124)	609
Application Note Abstracts	613

General Characteristics, Test Circuits, and Waveforms

POWER TRANSISTORS

Dissipation Derating Chart

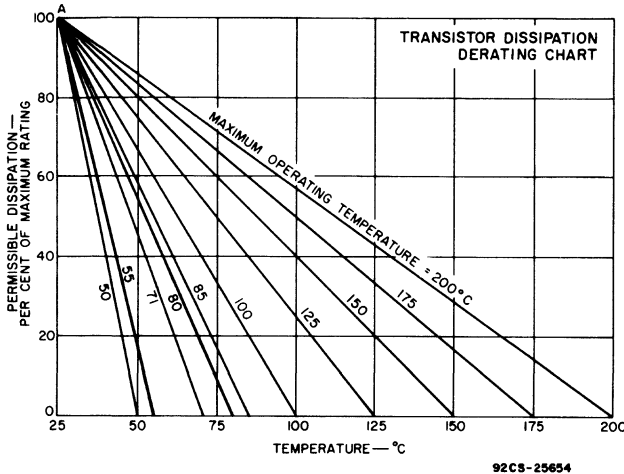


Fig. 1 - Dissipation derating chart for silicon power transistors operated at temperatures above 25°C.

For many transistors, the maximum value of dissipation is specified for ambient, case, or mounting-flange temperatures up to 25°C, and must be reduced linearly for higher temperatures. For such types, the chart above can be used to determine maximum permissible dissipation values at particular temperature conditions above 25°C. (This chart cannot be assumed to apply to types other than those for which it is specified that the maximum allowable dissipation is derated linearly to zero at the maximum allowable operating temperature, T_J (max.)) The curves show the permissible percentage of the maximum dissipation ratings as a function of ambient or case temperature. Individual curves are plotted for maximum operating temperatures of 50, 55, 75, 80, 85, 100, 125, 150, 175, and 200°C. If the maximum operating temperature of a transistor is some other value, a new curve can be drawn from point A in the figure to the desired temperature value on the abscissa. To use the chart, it is necessary to know the maximum dissipation rating and the maximum operating temperature for a given transistor. The calculation involves only two steps:

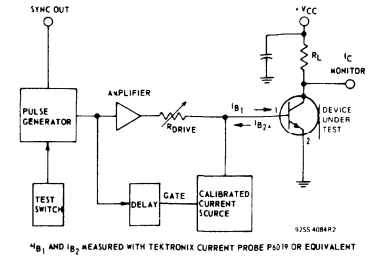
1. A vertical line is drawn at the desired operating temperature value on the abscissa to intersect the curve representing the maximum operating temperature for the transistor.
2. A horizontal line drawn from this intersection point to the ordinate establishes the permissible percentage of the maximum dissipation at the given temperature.

The following example illustrates the calculation of the maximum permissible dissipation for transistor type 2N1487 at a case temperature of 100°C. This type has a maximum dissipation rating of 75 watts at a case temperature of 25°C, and a maximum permissible case-temperature rating of 200°C.

1. A perpendicular line is drawn from the 100-degree point on the abscissa to the 200-degree curve.
2. Projection of this point to the ordinate shows a percentage of 57.5.

Therefore, the maximum permissible dissipation for the 2N1487 at a case temperature of 100°C is 0.575 times 75, or approximately 43 watts.

Switching-Time Measurements



* For p-n-p types, direction of currents and polarities of voltages are reversed.

Fig. 2 - Circuit used to measure switching times.

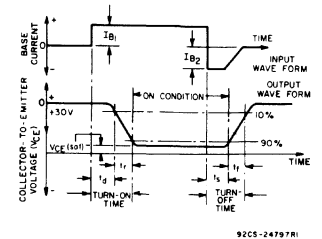


Fig. 3 - Oscilloscope display for measurement of switching times.

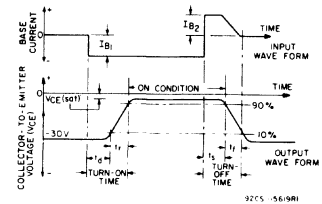
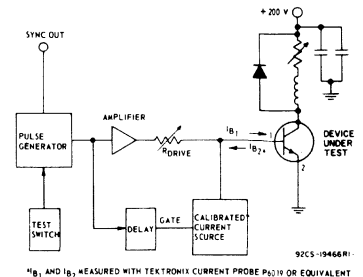


Fig. 4 - Oscilloscope display for measurement of switching times for p-n-p types.



* For p-n-p types, direction of currents and polarities of voltages are reversed.

Fig. 5 - Circuit used to measure inductive-load switching times.

POWER TRANSISTORS (Cont'd)

Breakdown (Sustaining) Voltage Tests

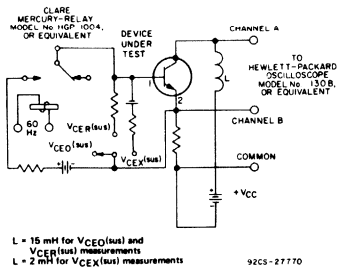


Fig. 6 - Basic configuration used to measure sustaining voltage $V_{CE0}(sus)$, $V_{CE(sus)}$, and $V_{CEX}(sus)$ for n-p-n power transistors.

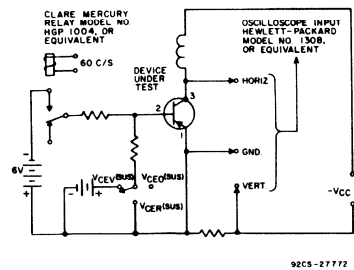


Fig. 8 - Basic circuit configuration used to measure sustaining voltages $V_{CE0}(sus)$, $V_{CE(sus)}$, and $V_{CEV}(sus)$ for p-n-p power transistors.

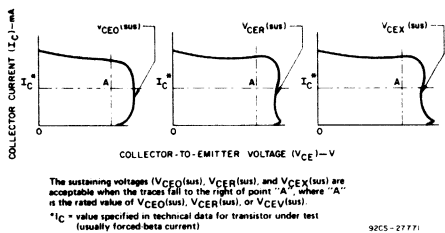


Fig. 7 - Oscilloscope display for measurement of sustaining voltages of n-p-n power transistors.

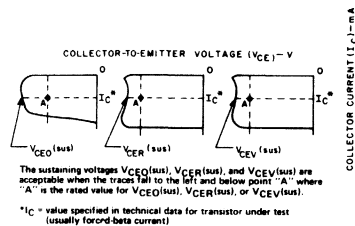


Fig. 9 - Oscilloscope display for measurement of sustaining voltages of p-n-p power transistors.

Inductive Load-Switching Measurements

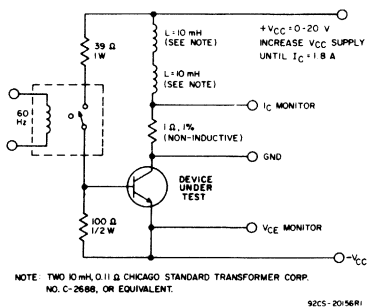


Fig. 10 - Circuit for measuring inductive-load switching for all types.

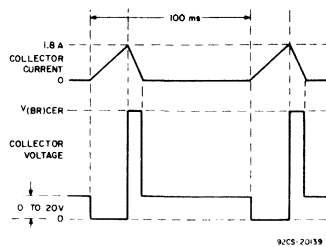


Fig. 11 - Inductive-load switching voltage and current waveforms .

HC2000H POWER HYBRID OPERATIONAL AMPLIFIER TEST CIRCUITS

PROCEDURE FOR MEASUREMENT OF COMMON-MODE INPUT IMPEDANCE

- Insert unit
- Apply ± 37.5 V
- Close S1
- Adjust signal generator for 1 V on voltmeter V1
- Open S1
- Read voltmeter V1
- Input impedance = $(10\text{ k}) \times \frac{V_1}{1 - V_1}$

Note: Circuit under test must have a heat sink so that $T_C \approx 25^\circ\text{C}$, unless otherwise noted.

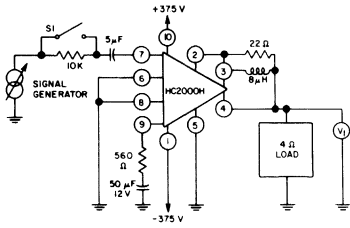


Fig.12 – Circuit for measurement of common-mode input impedance.

PROCEDURE FOR MEASUREMENT OF OFFSET VOLTAGE AND QUIESCENT CURRENT

- A = DC ammeter 100 mA range
V = DC voltmeter ± 250 mV range
- Close S1
 - Insert unit
 - Apply ± 37.5 V
 - Read offset voltage on voltmeter. Change polarity if required.
 - Open S1
 - Read positive and negative quiescent current on ammeter.

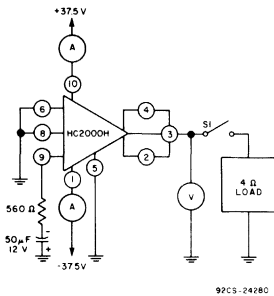


Fig.13 – Circuit for measurement of offset voltage and quiescent current.

HC2000H		
TERMINAL CONNECTIONS		
Pin No.	Connection	
1	$-V_S$	Negative supply voltage
2	V _{FB}	Feedback voltage
3	V _{OUT}	Output voltage
4	PC	Phase compensation
5	GND	Ground
6	BP	Base plate (internal connection)
7	$+V_{IN}$	Non-inverting input
8	GND	Ground
9	$-V_{IN}$	Inverting input
10	$+V_S$	Positive supply voltage

PROCEDURE FOR MEASUREMENT OF OPEN-LOOP GAIN

- Insert unit
- Apply ± 37.5 V
- Set generator at 1 kHz and adjust until $V_1 = 10$ V rms
- Read V2
- Open-loop gain = V_1/V_2

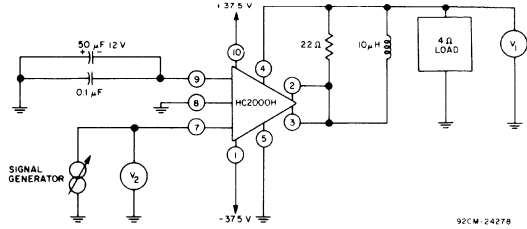


Fig.14 – Circuit for measurement of open-loop gain.

PROCEDURE FOR MEASUREMENT OF CLOSED LOOP VOLTAGE GAIN

- Insert unit
- Adjust signal generator to 1 kHz, $V_2 = 0$
- Apply ± 37.5 V
- Adjust signal generator for 2 V rms on voltmeter V1
- Read voltmeter V2
- Voltage gain = $\frac{V_1}{V_2}$

PROCEDURE FOR MEASUREMENT OF TOTAL HARMONIC DISTORTION

- Adjust signal generator for 15.5 V rms on V1
- Adjust distortion analyzer. Record the meter reading as Total Harmonic Distortion (THD).

PROCEDURE FOR MEASUREMENT OF MAXIMUM VOLTAGE SWING AND MAXIMUM POWER

- Adjust signal generator for maximum output on scope No. 1 with no clipping. Read peak voltage as maximum voltage swing.
- Read V_1
- Maximum power = $\frac{V_1^2}{4}$

PROCEDURE FOR MEASUREMENT OF SHORT CIRCUIT CURRENT

- Lower power supply to ± 26 V
- Momentarily replace 4-ohm load with 0.5-ohm load
- Scope No. 1 must show symmetrical square wave of less than ± 1.75 V

PROCEDURE FOR MEASUREMENT OF BANDWIDTH

- Raise power supply to ± 37.5 V
- Adjust signal generator at 43 kHz to 2 V rms on V1
- Adjust distortion analyzer and verify that THD < 0.5%

PROCEDURE FOR MEASUREMENT OF SLEW RATE

- Replace signal generator with square-wave generator.
- Adjust generator for 500 Hz and $V_1 = 40$ V peak-to-peak.
- Read time required for swing from peak to peak.
- Slew rate = $\frac{40\text{ V}}{\text{Measured time}}$

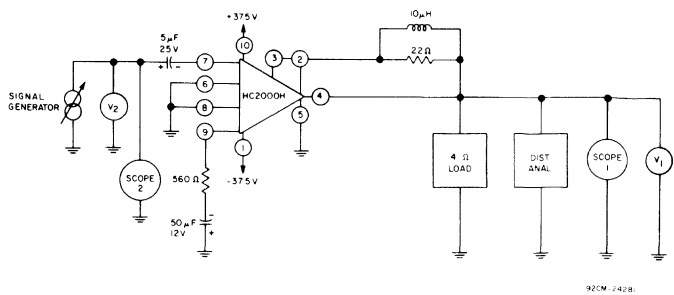


Fig.15 – Circuit for measurement of closed-loop voltage gain, total harmonic distortion, maximum voltage swing, maximum power, short-circuit current, bandwidth, and slew-rate.

HC2500 POWER HYBRID OPERATIONAL AMPLIFIER TEST CIRCUITS

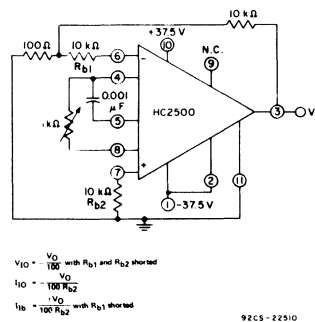
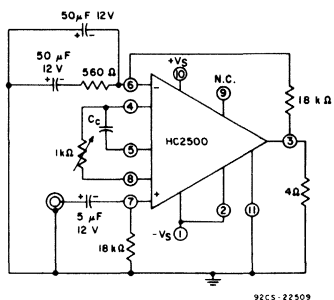


Fig. 16 – Test circuit for open-loop gain and phase response.

Fig. 17 – Test circuit for input offset voltage and current test.

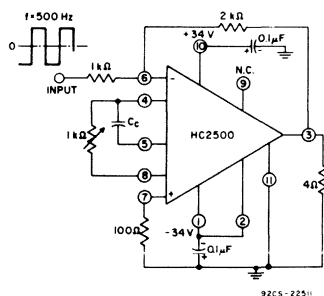


Fig. 18 – Circuit used to test slew rate.

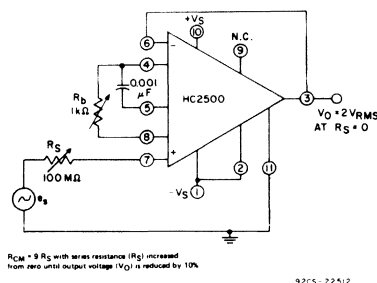


Fig. 19 – Test circuit for measuring common-mode input resistance.

HC2500

TERMINAL CONNECTIONS

Pin No.	Connection
1	Drive 2
2	-VS Negative supply voltage
3	VOUT Output Voltage
4	Bias adjust
5	Frequency compensation
6	-VIN Inverting input
7	+VIN Noninverting input
8	Bias adjust
9	Drive 1
10	+VS Positive supply voltage
11	BP Base plate (electrically isolated from internal circuitry)

THYRISTORS

Voltage-Current Characteristics

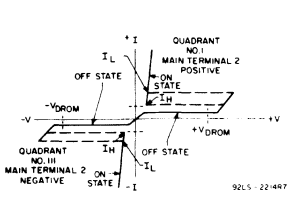


Fig. 20 - Principal voltage-current characteristic for a triac.

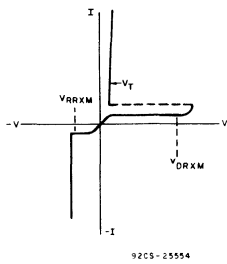


Fig. 22 - Anode-cathode voltage-current characteristic for a gate-turn-off SCR (GTO).

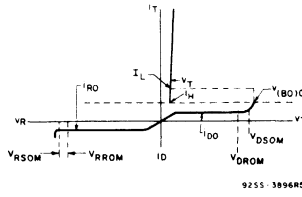


Fig. 21 - Principal voltage-current characteristic for a conventional SCR.

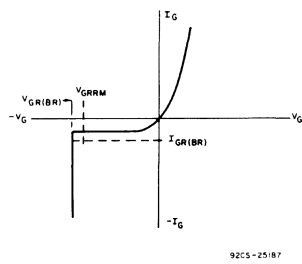


Fig. 23 - Gate-cathode voltage-current characteristic for a gate-turn-off SCR (GTO).

Critical Rate of Rise of On-State Current (di/dt)

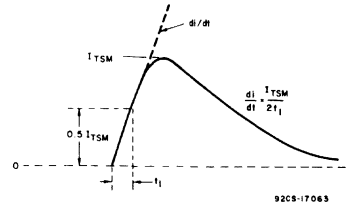
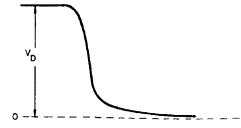


Fig. 24 - Rate of change of on-state current with time (defining di/dt) for a triac.

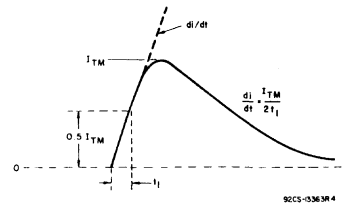
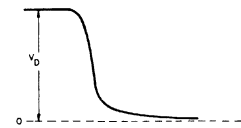


Fig. 25 - Rate of change of on-state current with time (defining di/dt) for an SCR.

Critical Rate of Rise of Off-State Voltage (Static and Commutating dv/dt)

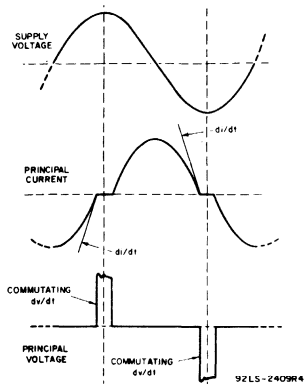


Fig. 26 - Relationship between supply voltage and principal current (inductive load) showing reference points for definition of commutating voltage (dv/dt) for a triac.

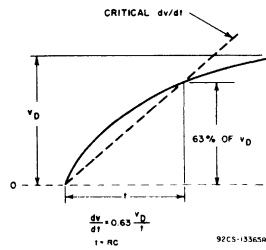


Fig. 27 - Rate of rise of off-state voltage with time (defining critical dv/dt) for general-purpose SCR's, gate-turn-off SCR's, and triacs.

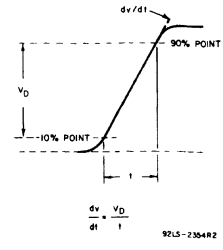


Fig. 28 - Rate of rise of off-state voltage with time (defining dv/dt) for an inverter SCR.

THYRISTORS (Cont'd)

Subcycle Surge-Current Test for SCR's

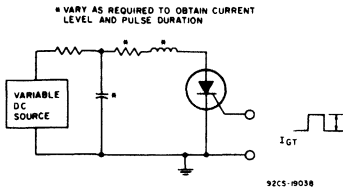


Fig.29 - Sub-cycle surge capability test circuit.

Turn-On-Time Waveforms

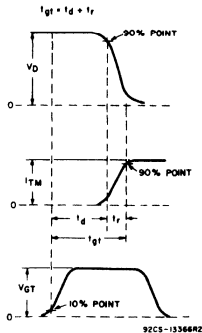


Fig.30 - Relationship between off-state voltage, on-state current, and gate-trigger voltage showing reference points for definition of turn-on time (t_{gt}) for triacs and SCR's.

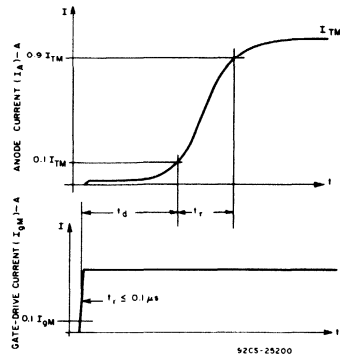


Fig.31 - Relationship between anode current (on-state), gate drive current, and time showing reference points for definition of gate controlled turn-on time (t_{gt}) for gate-turn-off SCR's.

Turn-Off-Time Test Circuits and Waveforms for SCR's

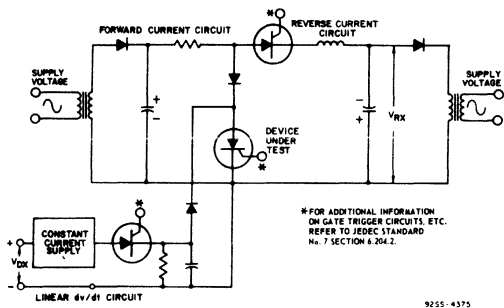


Fig. 32 - Circuit used to measure turn-off time (t_q) rectangular pulse.

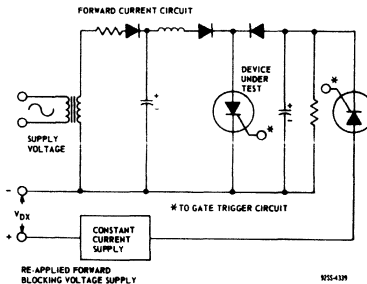


Fig.33 - Circuit used to measure turn-off time (t_q) half-sine wave pulse.

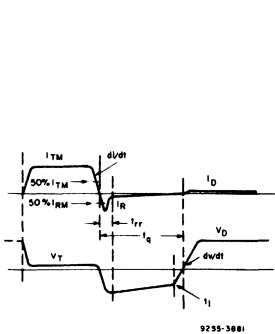


Fig.34 - Relationship between instantaneous on-state current and voltage showing reference points for definition of circuit commutated turn-off time (t_q) for general-purpose SCR's (rectangular pulse).

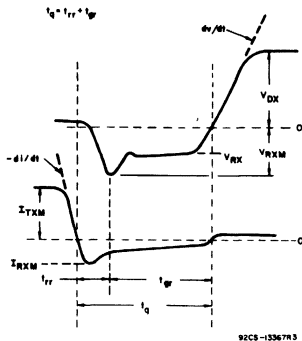


Fig.35 - Relationship between off-state voltage, reverse voltage, on-state current, and reverse current showing reference points defining turn-off time (t_q) for inverter SCR's (rectangular pulse).

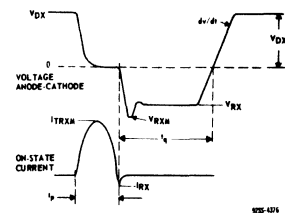


Fig.36 - Relationship between off-state voltage, reverse voltage, on-state current, and reverse current showing reference points for specification of turn-off time (t_q) for an inverter SCR (half-sine-wave pulse).

THYRISTORS (Cont'd)

Switching-Time Waveforms for Gate-Turn-Off SCR's

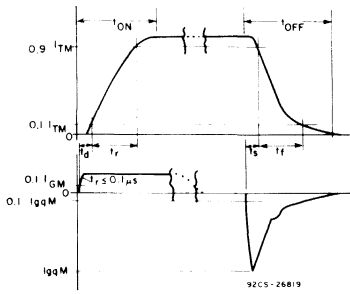


Fig. 37 — Relationship between anode current (on-state), gate-drive current, and time showing reference points for definition of t_{gt} (t_{ON}) and t_{gg} (t_{OFF}).

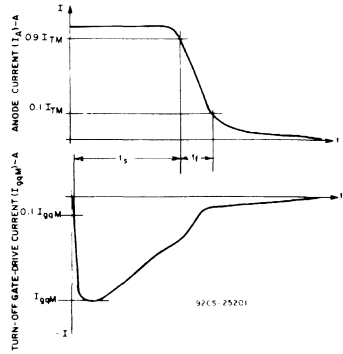
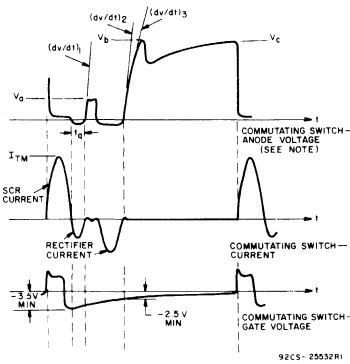


Fig. 38 — Relationship between anode current (on-state), turn-off gate-drive current, and time showing reference points for definition of gate-controlled turn-off time (t_{qq}).

Switching Waveforms for Deflection-Circuit ITR's



NOTE: "Commutating Switch-Anode Voltage" oscilloscope display has been modified graphically to show the measurement points of dv/dt more effectively.

Fig. 39 — Oscilloscope display of commutating switching ITR's showing circuit-commutated turn-off time (t_q).

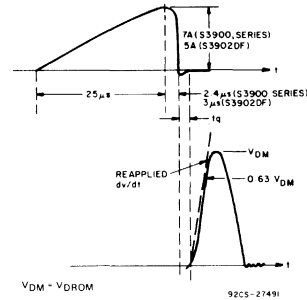


Fig. 40 — Oscilloscope display of trace switching ITR's (S3900 Series, S3902DF) showing circuit-commutated turn-off time (t_q).

Notes for Figs. 39 and 40

Circuit-commutated turn-off time (t_q), the sum of reverse recovery time and gate recovery time, is measured from the zero crossing of current to the start of the reappplied voltage. Knowledge of the current, the reappplied voltage, and the case temperature is necessary when measuring t_q . In the worst conditions (high line, zero beam, off-frequency, minimum auxiliary load, etc), turn-off time must not fall below the given values. Turn-off time increases with temperature, therefore, case temperature must not exceed $75^\circ C$ for all types.

THYRISTORS (Cont'd)

Reverse-Recovery-Time Measurements for Rectifier Unit of ITR

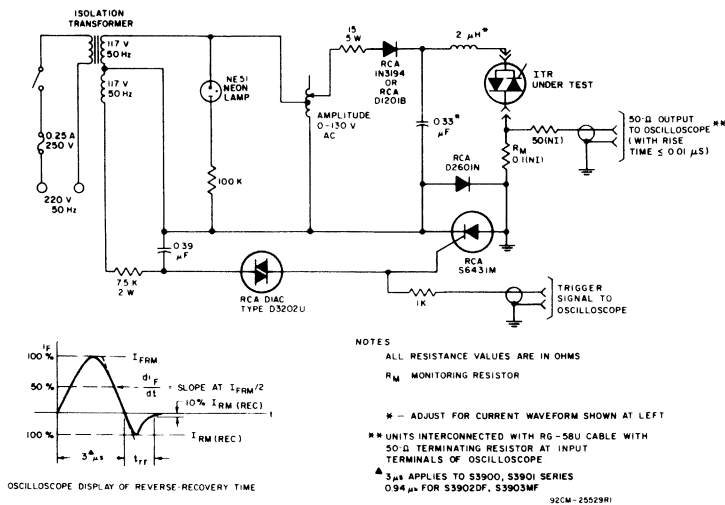


Fig.41 - Test circuit (pulsed sine wave) oscilloscope display for measurement of reverse-recovery time for rectifier unit of ITR.

Peak Forward-Voltage Measurements for Rectifier Unit of ITR

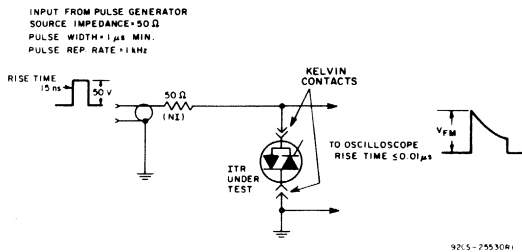


Fig.42 - Test circuit for measurement of peak forward voltage drop at turn-on for rectifier unit of ITR.

DIACS

Voltage-Current Characteristic

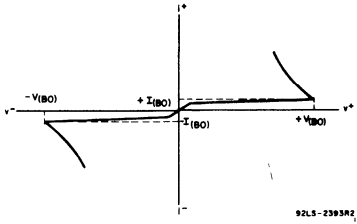
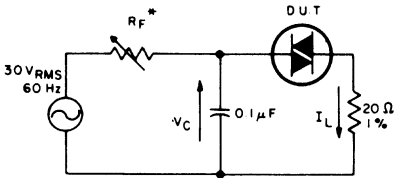


Fig.43 - Voltage-current characteristic for a diac.

Switching Measurements



* ADJUST FOR ONE FIRING IN HALF CYCLE
D.U.T. = DIAC UNDER TEST

92CS-20100

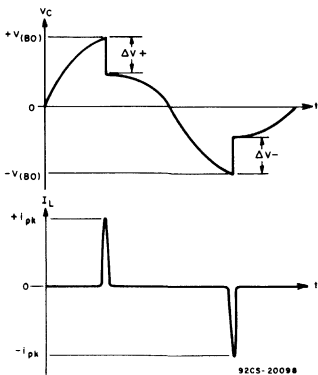
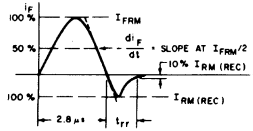
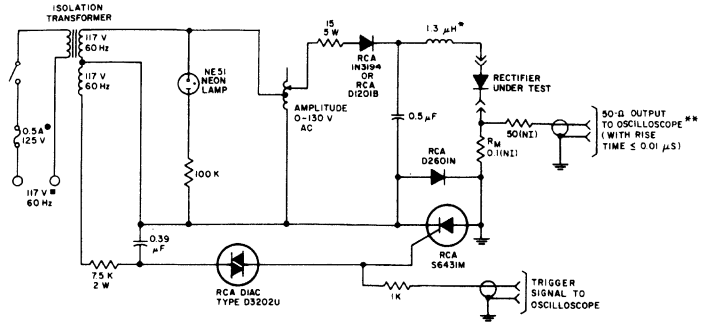


Fig.44 - Circuit and waveforms used to measure diac characteristics.

RECTIFIERS

Reverse-Recovery-Measurements

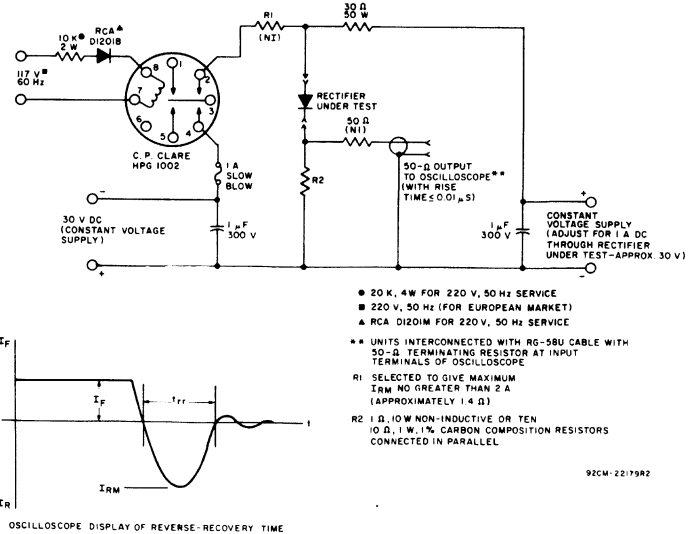


NOTES:
ALL RESISTANCE VALUES ARE IN OHMS
R_M MONITORING RESISTOR
● 1/4 A FOR 220 V, 50 HZ SERVICE
■ 220 V, 50 HZ (FOR EUROPEAN MARKET)
* - ADJUST FOR CURRENT WAVEFORM SHOWN AT LEFT
** UNITS INTERCONNECTED WITH RG-58U CABLE WITH 50-Ω TERMINATING RESISTOR AT INPUT TERMINALS OF OSCILLOSCOPE.

OSCILLOSCOPE DISPLAY OF REVERSE-RECOVERY TIME

92CM-17392R4

Fig.45 - Test circuit (pulsed sine wave) for measurement of reverse-recovery time.



● 20 K, 4 W FOR 220 V, 50 HZ SERVICE
■ 220 V, 50 HZ (FOR EUROPEAN MARKET)
▲ RCA D2020M FOR 220 V, 50 HZ SERVICE
** UNITS INTERCONNECTED WITH RG-58U CABLE WITH 50-Ω TERMINATING RESISTOR AT INPUT TERMINALS OF OSCILLOSCOPE
R₁ SELECTED TO GIVE MAXIMUM I_{FRM} NO GREATER THAN 2 A (APPROXIMATELY 1.4 Ω)
R₂ 1 Ω, 10 W NON-INDUCTIVE OR TEN 10 Ω, 1 W, 1% CARBON COMPOSITION RESISTORS CONNECTED IN PARALLEL

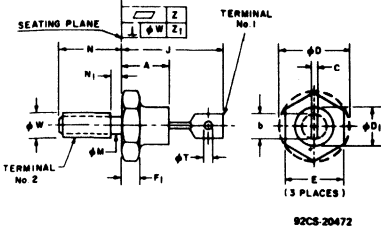
OSCILLOSCOPE DISPLAY OF REVERSE-RECOVERY TIME

92CM-22179R2

Fig.46 - Test circuit (pulsed dc) for measurement of reverse-recovery time.

Dimensional Outlines

DO-203MA/DO-4



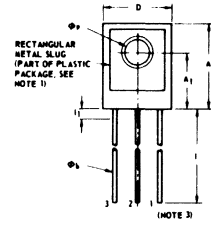
92CS-20472

SYMBOL	INCHES		MILLIMETERS		NOTES
	MIN.	MAX.	MIN.	MAX.	
A	-	0.405	-	10.28	2
b	-	0.250	-	6.35	
c	0.020	0.095	0.51	1.95	
ϕD	-	0.505	-	12.82	1
ϕD ₁	0.285	0.424	6.74	10.76	
E	0.423	0.438	10.76	11.12	
F ₁	0.075	0.175	1.91	4.44	
J	0.800	0.800	15.24	20.32	
ϕM	0.163	0.189	4.15	4.80	
N	0.422	0.453	10.72	11.50	
N ₁	-	0.078	-	1.98	
ϕT	0.080	0.085	1.53	2.41	
ϕW	-	10.32 UNF-2A	-	10.32 UNF-2A	
Z	-	0.002	-	0.050	3
Z ₁	-	0.005	-	0.152	

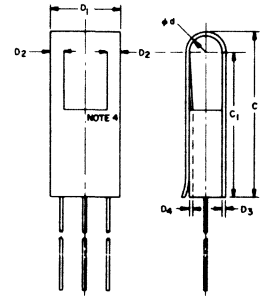
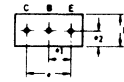
- NOTES:
 1: Chamfer or undercut on one or both sides of hexagonal base is optional.
 2: Angular orientation and contour of Terminal No. 1 is optional.

3: ϕW is pitch diameter of coated threads. REF: Screw Thread Standards for Federal Services, Handbook H 28 Part I. Recommended torque: 15 inch-pounds.

PLASTIC PACKAGES PLASTIC TO-5 AND PLASTIC TO-5 WITH HEAT CLIP

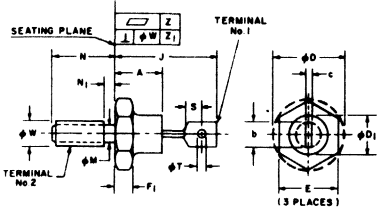


(NOTE 3)



92CS-19280

DO-203MB/DO-5

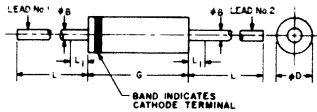


92CS-20473R1

SYMBOL	INCHES		MILLIMETERS		NOTES
	MIN.	MAX.	MIN.	MAX.	
A	-	0.450	-	11.43	1
b	-	0.375	-	9.52	
c	0.030	0.080	0.77	2.03	
ϕD	-	0.794	-	20.16	
ϕD ₁	-	0.687	-	16.94	
E	0.889	0.889	17.00	17.47	
F ₁	0.115	0.200	2.93	5.08	
J	0.750	1.000	19.05	25.40	
ϕM	0.220	0.249	5.59	6.32	
N	0.422	0.453	10.72	11.50	
N ₁	-	0.090	-	2.28	
S	0.156	-	3.97	-	
ϕT	0.140	0.175	3.56	4.44	
ϕW	-	1/4-28 UNF 2A	-	1/4-28 UNF 2A	
Z	-	0.002	-	0.050	
Z ₁	-	0.005	-	0.152	

NOTE
 1: ϕW is pitch diameter of coated threads. REF: Screw-Thread Standards for Federal Services, Handbook H 28 Part I. Recommended torque: 30 inch-pounds.

DO-204AC/DO-15

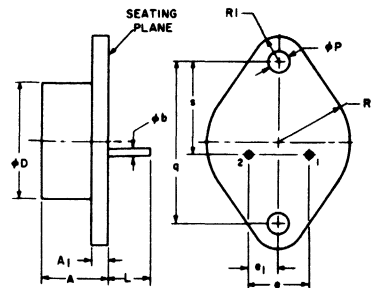


92CS-1735M1

SYMBOL	INCHES		MILLIMETERS	
	MIN.	MAX.	MIN.	MAX.
ϕb	0.027	0.035	0.686	0.889
ϕD	0.104	0.140	2.64	3.56
G	0.230	0.300	5.84	7.62
L	1.000	-	25.40	-
L ₁	-	0.050	-	1.27

*Within this zone the diameter may vary to allow for lead finishes and irregularities.

TO-204MA/TO-3



SYMBOL	INCHES		MILLIMETERS		NOTES
	MIN.	MAX.	MIN.	MAX.	
A	0.250	0.450	6.4	11.4	1
A ₁	-	0.135	-	3.42	
ϕb	0.038	0.043	0.966	1.092	2
ϕD	-	0.875	-	22.22	
e	0.420	0.440	10.67	11.17	
e ₁	0.205	0.225	5.21	5.71	
L	0.312	-	7.93	-	
ϕP	0.151	0.161	3.84	4.08	
Q	1.177	1.197	29.90	30.40	
R	-	0.525	-	13.33	
R ₁	-	0.188	-	4.77	
S	0.655	0.675	16.64	17.14	

- NOTES:
 1. Two pins.
 2. Two holes.
 3. At both ends

92CS-15222R2

SYMBOL	INCHES		MILLIMETERS		NOTES
	MIN.	MAX.	MIN.	MAX.	
A	0.385	0.395	9.78	10.03	2
A ₁	0.251	0.251	6.37	6.43	
ϕb	0.016	0.019	0.41	0.48	
C	0.858	-	21.79	-	
C ₁	0.750	-	19.05	-	
D	0.305	0.315	7.75	8.00	
D ₁	0.300	-	7.62	-	
D ₂	0.870	-	1.77	-	
D ₃	0.8329	-	0.813	-	
D ₄	0.021	0.041	0.533	1.04	
ϕd	0.073	0.077	1.85	1.95	
e	0.146	0.155	3.66	3.94	
e	0.195	0.205	4.95	5.21	
e ₁	0.085	0.105	2.41	2.67	
e ₂	0.070	0.080	1.78	2.03	
f	0.725	0.745	18.41	18.91	
f ₁	0.125	0.250	3.17	6.35	
ϕp	0.112	0.118	2.84	2.99	

NOTE 1: To attach to heat-sink, use a 4-40 binding-head screw and a No. 4 flat washer. The recommended screw torque (for even distribution of mounting pressure and optimum thermal contact) is 6 in.-lb.

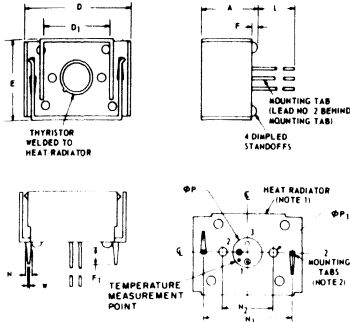
NOTE 2: Three leads. Leads are returned to the f₁ dimension.

NOTE 3: Lead numbering from right to left with rectangular metal slug facing observer.

NOTE 4: Tab to be sheared through and set inward as shown.

Dimensional Outlines

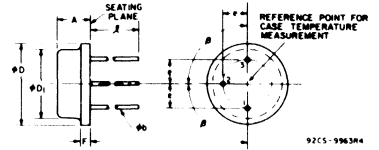
"MOD. TO-5" WITH HEAT RADIATOR



SYMBOL	INCHES		MILLIMETERS		NOTES
	MIN	MAX	MIN	MAX	
A	-	630	-	16.00	
D	1.205	1.235	30.61	31.37	
D ₁	745	755	18.923	19.177	
E	875	905	22.22	22.99	
F	0.40	0.55	1.02	1.40	
F ₁	170	225	4.32	5.72	
L	920	-	23.37	-	
ΦP	295	305	7.493	7.747	
ΦP ₁	093	095	2.362	2.413	
N	048	062	1.21	1.57	
N ₁	998	1,002	25.349	25.450	3
N ₂	687	689	17.45	17.50	3
W	048	052	1.219	1.320	

- NOTES:
- 0.035 C.R.S., finish: electroless nickel plate
 - Recommended hole size for printed-circuit board is 0.070 in. (1.78 mm) dia.
 - Measured at bottom of heat radiator

TO-8

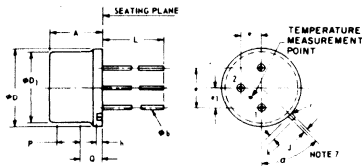


SYMBOL	INCHES		MILLIMETERS		NOTES
	MIN	MAX	MIN	MAX	
A	0.270	0.330	6.86	8.38	-
ob	0.027	0.033	0.686	0.838	1
oD	0.550	0.650	13.97	16.51	-
oD ₁	0.444	0.524	11.28	13.31	-
e	0.136	0.146	3.45	3.71	-
F	-	0.115	-	2.92	-
l	0.360	0.440	9.14	11.18	1
l ₁	90 NOMINAL				

NOTE:

- Three leads

"LOW-PROFILE TO-5"



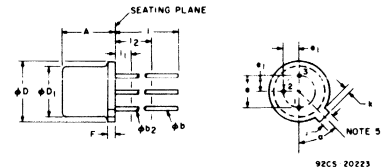
SYMBOL	INCHES		MILLIMETERS		NOTES
	MIN	MAX	MIN	MAX	
A	.160	.180	4.06	4.57	
Φb	.017	.021	.432	.533	2
ΦD	.355	.366	9.017	9.296	
ΦD ₁	.323	.335	8.204	8.51	
e	.190	.210	4.83	5.33	
e ₁	100 TRUE POSITION		2.54 TRUE POSITION		4,5
h	.015	.035	.381	.889	
J	.028	.035	.711	.889	5
k	.029	.045	.737	1.14	3,5
L	.985	1.015	25.02	25.78	2
P	100		2.54		1
Q				.179	6
r		.007			
α	42°	48°			5,7

NOTES:

- This zone is controlled for automatic handling. The variation in actual diameter within this zone shall not exceed 0.012 in. (0.279 mm)
- (Three Leads) a b applies between seating plane and 1.015 in. (25.78 mm)
- Measured from maximum diameter of the actual device
- Leads having maximum diameter 0.021 in. (0.533 mm) measured at the seating plane of the device shall be within .007 in. (0.178 mm) of their true positions relative to the maximum width tab.

- The device may be measured by direct methods or by the gage and gaging procedure described on gage drawing GS-1 of JEDEC publication 12E, May 1964
- Details of outline in this zone optional.
- Tab centerline

TO-206MA/TO-18

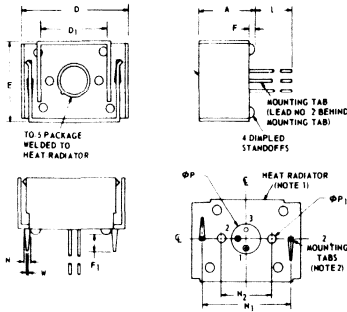


SYMBOL	INCHES		MILLIMETERS		NOTES
	MIN	MAX	MIN	MAX	
A	0.170	0.210	4.32	5.33	
ob	0.016	0.021	0.406	0.533	1
ob ₂	0.016	0.019	0.406	0.483	1
oD	0.209	0.230	5.31	5.84	
oD ₁	0.178	0.195	4.52	4.95	
e	0.100 T.P.		2.54 T.P.		2, 4
e ₁	0.060 T.P.		1.27 T.P.		2, 4
F	-	0.030	-	0.762	
j	0.036	0.046	0.914	1.17	4
k	0.028	0.048	0.711	1.22	3
l	0.500		12.70		1
l ₁		0.050		1.27	1
l ₂	0.250		6.35		1
α	45° T.P.				5

NOTES:

- (Three leads) ob₂ applies between l₁ and l₂. ob applies between l₂ and 0.5 in. (12.70 mm) from seating plane. Diameter is uncontrolled in l₁ and beyond 0.5 in. (12.70 mm) from seating plane.
- Leads having maximum diameter 0.019 in. (0.483 mm) measured in gaging plane 0.064 in. (1.37 mm) ± 0.001 in. (0.025 mm) - 0.00 in. (0.00 mm) below the seating plane of the device shall be within 0.007 in. (0.178 mm) of their true positions relative to a maximum width tab.
- Measured from maximum diameter of the actual device.
- The device may be measured by direct methods or by the gage and gaging procedure described on gage drawing GS-2.
- Tab centerline.

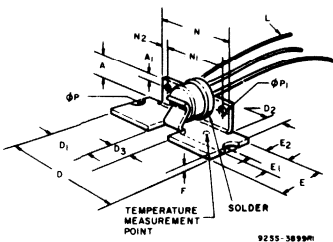
"LOW-PROFILE TO-5" WITH HEAT RADIATOR



SYMBOL	INCHES		MILLIMETERS		NOTES
	MIN	MAX	MIN	MAX	
A	-	630	-	16.00	
D	1.205	1.235	30.61	31.37	
D ₁	745	755	18.923	19.177	
E	875	905	22.22	22.99	
F	0.40	0.55	1.02	1.40	
F ₁	170	225	4.32	5.72	
L	885	-	22.48	-	
ΦP	295	305	7.493	7.747	
ΦP ₁	093	095	2.362	2.413	
N	048	062	1.21	1.57	
N ₁	998	1,002	25.349	25.450	3
N ₂	687	689	17.45	17.50	3
W	048	052	1.219	1.320	

- NOTES:
- 0.035 C.R.S., finish: electroless nickel plate
 - Recommended hole size for printed-circuit board is 0.070 in. (1.78 mm) dia.
 - Measured at bottom of heat-radiator

"LOW-PROFILE TO-5" WITH HEAT SPREADER



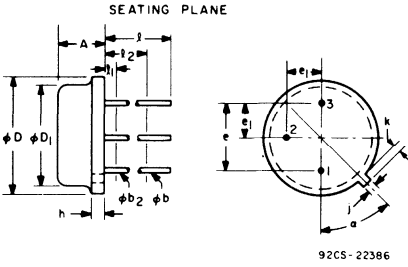
SYMBOL	INCHES		MILLIMETERS		NOTES
	MIN	MAX	MIN	MAX	
A	0.22		5.58		
A ₁	0.75		19.05		
D	1.0		25.4		
D ₁	0.406		10.31		
D ₂	0.14	0.16	3.55	4.06	
D ₃	0.188		4.77		
E	0.40		10.16		
E ₁	0.32		8.12		
E ₂	0.156		3.96		
F	0.02		0.05		
L	0.95		24.13		1
N	0.69	0.71	17.52	18.03	
N ₁	0.55		13.97		
N ₂	0.75		19.05		
ΦP	0.072 Rad		1.83 Rad		
ΦP ₁	0.094 Dia.		2.39 Dia.		2

NOTES:

- Min. length, 3 leads.
- Two holes.

Dimensional Outlines

TO-206MB/TO-46

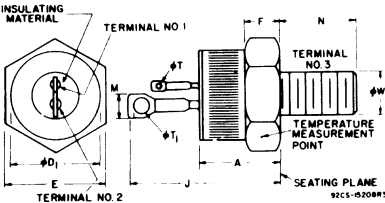


SYMBOL	INCHES		MILLIMETERS		NOTES
	MIN.	MAX.	MIN.	MAX.	
A	0.085	0.085	1.85	2.16	
φb	0.016	0.021	0.408	0.533	1
φb ₂	0.012	0.019	0.306	0.483	1
φD	0.209	0.230	5.31	5.84	
φD ₁	0.178	0.195	4.52	4.95	
e	0.100 T.P.		2.54 T.P.		2
e ₁	0.050 T.P.		1.27 T.P.		2
h		0.040		1.02	
j	0.036	0.046	0.914	1.17	
k	0.028	0.048	0.711	1.22	4
l	0.500		12.70		1
l ₂		0.050		1.27	1
l ₂	0.250		6.35		1
a		45° T.P.		45° T.P.	3, 5

NOTES:

- (THREE LEADS) φb₂ APPLIES BETWEEN e₁ AND e₂. φb APPLIES BETWEEN e₂ AND 0.5 IN. (12.70 MM) FROM SEATING PLANE. DIAMETER IS UNCONTROLLED IN e₁ AND BEYOND 0.5 IN. (12.70 MM) FROM SEATING PLANE.
- MAXIMUM DIAMETER LEADS AT A GAGING PLANE 0.054 IN. (1.37 MM) + 0.001 IN. (0.025 MM) 0.000 IN. (0.000 MM) BELOW SEATING PLANE TO BE WITHIN 0.007 IN. (0.178 MM) OF THEIR POSITION RELATIVE TO MAXIMUM-WIDTH TAB AND TO THE MAXIMUM 0.230 IN. (5.84 MM) DIAMETER MEASURED WITH A SUITABLE GAGE. WHEN GAGE IS NOT USED, MEASUREMENT WILL BE MADE AT SEATING PLANE.
- INDEX TAB FOR VISUAL ORIENTATION ONLY.
- MEASURED FROM MAXIMUM DIAMETER OF THE ACTUAL DEVICE.
- TAB CENTERLINE.

TO-208MA/TO-48

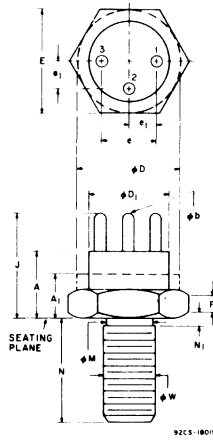


NOTE
1. φW is pitch diameter of coated threads.

SYMBOL	INCHES		MILLIMETERS		NOTES
	MIN.	MAX.	MIN.	MAX.	
A	0.330	0.505	8.4	12.8	
φD ₁	-	0.544	-	13.81	
E	0.544	0.562	13.82	14.28	
F	0.113	0.200	2.87	5.08	
J	0.950	1.100	24.13	27.94	
M	0.215	0.225	5.46	5.71	
N	0.422	0.453	10.72	11.50	
φT	0.055	0.098	1.47	1.73	
φT ₁	0.138	0.148	3.51	3.75	
φW	1/4-28 UNF-2A		1/4-28 UNF-2A		1

REF: Screw Thread Standards for Federal Services, Handbook H28, Part I: Recommended Torque: .25 inch-pounds.

TO-212MA/TO-60



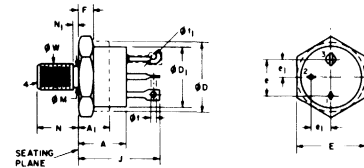
SYMBOL	INCHES		MILLIMETERS		NOTES
	MIN.	MAX.	MIN.	MAX.	
A	0.215	0.320	5.46	8.13	
A ₁	-	0.165	-	4.19	2
φb	0.030	0.046	0.762	1.17	4
φD	0.360	0.437	9.14	11.10	2
φD ₁	0.320	0.380	8.13	9.14	
E	0.424	0.437	10.77	11.10	
e	0.186	0.215	4.70	5.46	
e ₁	0.090	0.110	2.29	2.79	
F	0.090	0.136	2.29	3.43	1
J	0.366	0.480	9.02	12.19	
φM	0.163	0.189	4.14	4.80	
N	0.375	0.466	9.53	11.56	
N ₁	-	0.078	-	1.98	
φW	0.1858	0.1897	4.212	4.310	3, 5

MILLIMETER DIMENSIONS ARE DERIVED FROM ORIGINAL INCH DIMENSIONS

NOTES:

- Dimension does not include sealing flanges
- Package contour optional within dimensions specified
- Pitch diameter - 10-32 UNF 2A thread (coated)
- Pin spacing permits insertion in any socket having a pin-circles diameter of 0.200 in. (5.08 mm) and contacts which will accommodate pins with a diameter of 0.030 in. (0.762 mm) min., 0.046 in. (1.17 mm) max.
- The torque applied to a 10-32 hex nut assembled on the thread during installation should not exceed 12 inch-pounds.

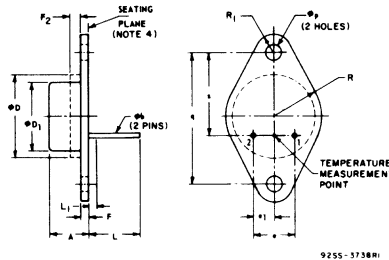
TO-211MB/TO-63



SYMBOL	INCHES		MILLIMETERS		NOTES
	MIN.	MAX.	MIN.	MAX.	
A	0.480	0.530	12.19	13.58	
A ₁	0.300	-	7.62	-	2
φD	0.775	0.875	19.89	22.23	2
φD ₁	0.746	0.775	18.92	19.66	
E	0.866	0.875	21.72	22.23	
e	0.486	0.515	12.32	13.08	5
e ₁	0.240	0.280	6.10	6.80	5
F	0.080	0.167	2.29	4.24	1
J	0.937	1.030	23.80	26.16	
φM	0.278	0.312	7.08	7.92	
N	0.480	0.486	11.86	12.57	
N ₁		0.106		2.67	
φT	0.080	0.106	1.82	2.67	
φT ₁	0.080	0.106	1.82	2.67	4
φW	0.2808	0.2864	7.127	7.289	3

- DIMENSION DOES NOT INCLUDE SEALING FLANGES
- PACKAGE CONTOUR OPTIONAL WITHIN DIMENSIONS SPECIFIED
- PITCH DIAMETER - THREAD IS 10-32 UNF 2A (COATED) REFERENCE (SCREW THREAD STANDARDS FOR FEDERAL SERVICES - HANDBOOK H.28)
- THIS TERMINAL CAN BE FLATTENED AND PIERCED OR HOOK TYPE
- POSITION OF LEADS IN RELATION TO THE HEXAGON IS NOT CONTROLLED

TO-213MA/TO-66



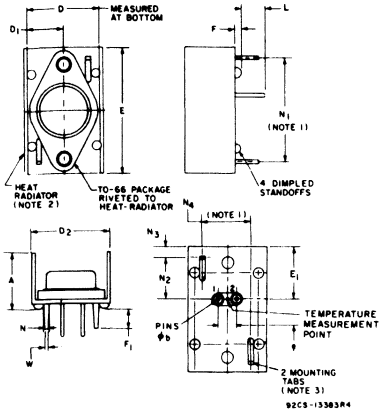
SYMBOL	INCHES		MILLIMETERS		NOTES
	MIN.	MAX.	MIN.	MAX.	
A	0.250	0.340	6.35	8.64	
φb	0.028	0.034	0.711	0.863	
φD	-	0.620	-	15.75	
φD ₁	0.470	0.500	11.94	12.70	1
e	0.180	0.210	4.83	5.33	2
e ₁	0.083	0.107	2.36	2.72	2
F ₁	0.050	0.076	1.27	1.91	
F ₂	-	0.050	-	1.27	1
L	0.380	-	9.14	-	
L ₁	-	0.050	-	1.27	3
φp	0.142	0.152	3.61	3.86	
φr	0.868	0.962	24.33	24.43	
R	-	0.350	-	8.80	
R ₁	-	0.145	-	3.68	
s	0.570	0.590	14.48	14.99	

NOTES:

- Body contour is optional within zone defined by φD and F₂.
- These dimensions should be measured at points 0.050 in. (1.27 mm) to 0.055 in. (1.40 mm) below seating plane. When gage is not used, measurement will be made at seating plane.
- φb applies between L₁ and L. Diameter is uncontrolled in L₁.
- The seating plane of header shall be flat within 0.001 in. (0.025 mm) concave to 0.004 in. (0.10 mm) convex inside a 0.520 in. (13.21 mm) diameter circle on the center of the header and flat within 0.001 in. (0.025 mm) concave to 0.008 in. (0.15 mm) convex overall.

Dimensional Outlines

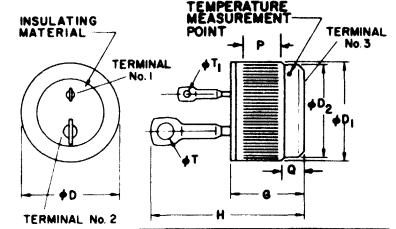
TO-66 WITH HEAT RADIATOR



SYMBOL	INCHES		MILLIMETERS		NOTES
	MIN.	MAX.	MIN.	MAX.	
A	—	0.620	—	15.75	
φb	0.028	0.034	0.711	0.864	
D	0.750	0.760	19.05	19.30	
D1	0.370	0.385	9.40	9.78	
D2	0.820	0.920	20.83	23.37	
E	1.297	1.327	32.94	33.70	
E1	0.546	0.568	13.87	14.37	
e	0.190	0.210	4.83	5.33	
F	0.30	0.56	7.62	13.97	
F1	0.175	0.210	4.44	5.33	
L	0.270	—	6.86	—	
N	0.062	0.085	1.32	1.85	
N1	1.008	1.102	27.89	27.99	
N2	0.448	0.462	11.38	11.47	
N3	0.099	0.113	0.25	0.29	
N4	0.498	0.502	12.65	12.75	
W	0.048	0.060	1.22	1.52	

NOTES:
 1 Measured at bottom of heat radiator.
 2 0.025 in. (0.635 mm) C.R.S. rivet used.
 3 Recommended hole size for printed-circuit board is 0.070 in. (1.778 mm).

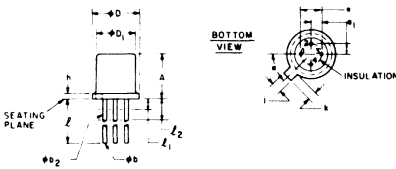
TO-203AA PRESS-FIT 6-, 10-, AND 15-A TRIACS; 20- AND 35-A SCR's



SYMBOL	INCHES		MILLIMETERS		NOTES
	MIN.	MAX.	MIN.	MAX.	
φD	—	0.510	—	12.95	1
φD1	0.501	0.505	12.726	12.827	2
φD2	0.465	0.475	11.82	12.06	
G	0.330	0.380	8.39	9.65	
H	—	0.800	—	20.32	
P	0.100	—	2.54	—	2
Q	0.080	0.097	—	—	
φT	0.065	0.090	1.66	2.28	3,4
φT1	0.035	0.068	0.89	1.72	

NOTES:
 1. Outline contour is optional within zone defined by φD and G min. and H max.
 2. Straight knurl surface.
 3. Elongated hole in terminal is optional.
 4. Contour and orientation of terminal 1 and terminal 2 are not defined.
 5. Terminal 1 to be shorter than terminal 2 for identification.
 92CS-23134R1

TO-206MD/TO-72



Note 1: (Four leads). Maximum number leads omitted in this outline, "none" (0). The number and position of leads actually present are indicated in the product registration. Outline designation determined by the location and minimum angular or linear spacing of any two adjacent leads.

Note 2: (All leads) φb applies between l1 and l2. φb applies between l2 and 0.50 in. (12.70 mm) from seating plane. Diameter is uncontrolled in l1 and beyond 0.50 in. (12.70 mm) from seating plane.

Note 3: Measured from maximum diameter of the product.

Note 4: Leads having maximum diameter 0.019 in. (0.484 mm) measured in gaging plane 0.054 in. (1.37 mm) ±0.001 in. (0.025 mm) — 0.000 (0.000 mm) below the seating plane of the product shall be within 0.007 in. (0.178 mm) of their true position relative to a maximum width tab.

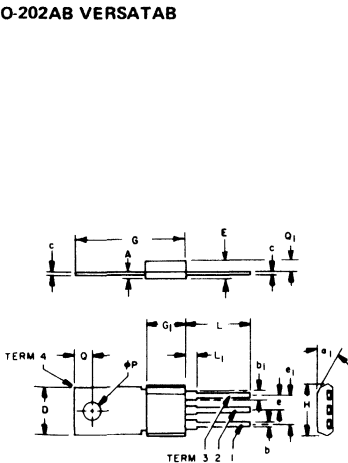
Note 5: The product may be measured by direct methods or by gage.

Note 6: Tab centerline.

SYMBOL	INCHES		MILLIMETERS		NOTES
	MIN.	MAX.	MIN.	MAX.	
A	0.170	0.210	4.32	5.33	
φb	0.018	0.021	0.46	0.53	2
φD	0.016	0.019	0.406	0.483	2
φD1	0.209	0.230	5.31	5.84	
φD2	0.178	0.195	4.52	4.95	
F	0.100 T.P.	—	2.54 T.P.	—	4
F1	0.050 T.P.	—	1.27 T.P.	—	4
h	0.030	—	0.762	—	
i	0.036	0.046	0.914	1.17	
k	0.028	0.048	0.711	1.22	3
l	0.500	—	12.70	—	2
l1	—	0.050	—	1.27	2
l2	0.250	—	6.35	—	2
z	—	45 T.P.	—	45 T.P.	4, 6

92CS-17444R1

TO-202AB VERSATAB

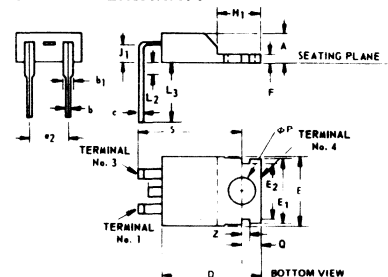


SYMBOL	INCHES		MILLIMETERS		NOTES
	MIN.	MAX.	MIN.	MAX.	
A	—	0.05	—	1.270	1
b	0.023	0.029	0.584	0.736	
c	0.018	0.026	0.457	0.660	
b1	0.045	0.055	1.143	1.397	1
D	0.305	0.325	7.747	8.255	
E	0.130	0.150	3.302	3.810	
e	0.095	0.105	2.413	2.667	
e1	0.190	0.210	4.826	5.334	
F	—	0.08	—	2.032	1
G	0.760	0.840	19.31	21.33	
G1	0.230	0.250	5.842	6.350	
H	0.330	0.370	8.382	9.398	
L	0.400	0.450	10.16	11.43	
L1	0.050	0.100	1.27	2.54	
φP	0.123	0.127	3.124	3.225	
Q	0.120	0.130	3.048	3.302	
Q1	0.039	0.050	0.990	1.270	
φ1	—	50°	—	50°	1

TEMPERATURE MEASUREMENT: 92CS-24062R2
 1/16 in. (1.58 mm) from plastic encapsulation on either mounting flange (terminal No. 4) or anode lead (terminal No. 2).

NOTES:
 1. Package contour optional within dimensions specified.
 2. Lead dimensions uncontrolled in this zone.
 3. Chamfer on tab optional.
 4. Controlling dimensions: inch.

TO-220AA VERSAWATT

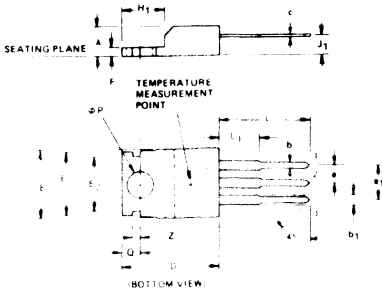


SYMBOL	INCHES		MILLIMETERS		NOTES
	MIN.	MAX.	MIN.	MAX.	
A	0.140	0.190	3.56	4.82	—
b	0.020	0.045	0.51	1.14	—
b1	0.045	0.070	1.14	1.77	—
c	0.015	0.025	0.38	0.63	—
D	0.560	0.625	14.23	15.87	—
E	0.380	0.420	9.66	10.66	1
E1	0.385	0.385	9.78	9.77	—
E2	0.300	0.320	7.62	8.12	—
F	0.190	0.210	4.83	5.33	2
φ	0.045	0.055	1.14	1.39	—
H1	0.230	0.270	5.85	6.85	1
J1	0.080	0.115	2.04	2.92	—
L2	—	0.050	—	1.27	—
L3	0.360	0.422	9.15	10.71	—
φP	0.139	0.147	3.531	3.733	—
Q	0.100	0.120	2.54	3.04	—
S	0.580	0.610	14.74	15.49	—
Z	0.040	0.060	1.02	1.52	—

NOTES:
 92CS-17990R2
 1. Tab contour optional within H1 and E.
 2. Position of lead to be measured 0.050 — 0.055 in. (1.270 — 1.397 mm) below seating plane.

Dimensional Outlines

TO-220AB VERSAWATT

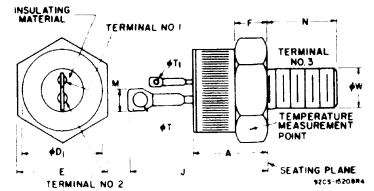


SYMBOL	INCHES		MILLIMETERS		NOTES
	MIN.	MAX.	MIN.	MAX.	
A	0.140	0.190	3.56	4.82	-
b	0.020	0.045	0.51	1.14	-
b1	0.045	0.070	1.14	1.77	-
c	0.015	0.025	0.38	0.63	-
D	0.560	0.625	14.23	15.87	-
E	0.380	0.420	9.66	10.66	i
E1	0.365	0.385	9.28	9.77	-
E2	0.300	0.320	7.62	8.12	-
e	0.090	0.110	2.29	2.79	2
e1	0.190	0.210	4.83	5.33	2
F	0.045	0.055	1.14	1.39	-
H1	0.230	0.270	5.85	6.85	1
J1	0.080	0.115	2.04	2.92	-
L	0.500	0.562	12.70	14.27	-
L1	-	0.250	-	6.35	-
φP	0.139	0.147	3.531	3.733	-
Q	0.100	0.120	2.54	3.04	-
Z	0.040	0.060	1.02	1.52	-

92SS 17991R2

- NOTES
 1 Tab contour optional within H₁ and E
 2 Position of lead to be measured 0.250 - 0.255 in (6.350 - 6.477 mm) from case

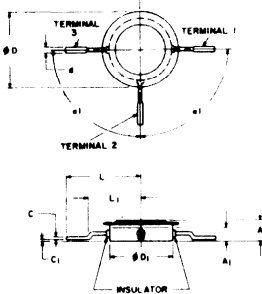
STUD 25-, 30-, AND 40-A TRIACS



SYMBOL	INCHES		MILLIMETERS		NOTES
	MIN.	MAX.	MIN.	MAX.	
A	0.330	0.505	8.4	12.8	-
φD1	-	0.544	-	13.81	-
E	0.544	0.562	13.82	14.28	-
F	0.113	0.200	2.87	5.08	-
J	0.950	1.100	24.13	27.94	-
M	0.215	0.225	5.46	5.71	-
N	0.422	0.453	10.72	11.50	-
φT1	0.058	0.068	1.47	1.73	-
φT	0.138	0.148	3.50	3.75	-
φW	1/4-28 UNF-2A	1/4-28 UNF-2A	1	1	1

- NOTE
 1. φW is pitch diameter of coated threads.
 REF: Screw Thread Standards for Federal Services, Handbook H28, Part I. Recommended Torque: 35 in-lbf (0.4 kg f-m) Maximum Torque: 50 in-lbf (0.57 kg f-m)

RADIAL PACKAGE

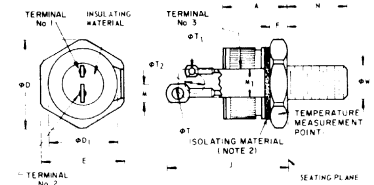


SYMBOL	INCHES		MILLIMETERS		NOTES
	MIN.	MAX.	MIN.	MAX.	
A	-	0.126	-	3.17	1
A1	0.016	0.018	0.38	0.48	-
C1	-	0.018	-	0.38	-
φD	-	0.710	-	18.03	-
φD1	0.016	0.080	0.41	2.03	1
d	0.042	0.048	1.06	1.18	-
L	-	0.708	-	17.90	-
L1	-	0.010	-	0.254	-

92CS 20224

- NOTE
 1 CONTROLLED AREA OF THE DIAMETER DOES NOT INCLUDE THE BRAZED AREA AROUND THE CERAMIC AND TERMINAL 2

ISOLATED-STUD 6-, 10-, AND 15-A TRIACS; 20- AND 35-A SCR'S

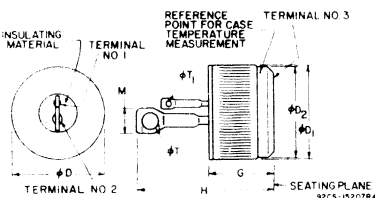


SYMBOL	INCHES		MILLIMETERS		NOTES
	MIN.	MAX.	MIN.	MAX.	
A	-	0.673	-	17.09	-
φD	0.604	0.614	15.34	15.59	-
φD1	0.501	0.505	12.72	12.82	-
E	0.551	0.557	13.99	14.14	-
F	0.100	0.185	2.50	4.69	-
J	-	1.055	-	26.79	-
M	-	0.155	-	3.94	-
M1	0.200	0.210	5.08	5.33	-
N	0.422	0.452	10.72	11.48	-
φT1	0.058	0.068	1.47	1.73	-
φT	0.080	0.090	2.03	2.29	-
φT2	0.138	0.148	3.50	3.75	-
φW	1/4-28 UNF-2A	1/4-28 UNF-2A	1	1	1

- NOTES:
 1. φW is pitch diameter of coated threads.
 REF: Screw Thread Standards for Federal Services, Handbook H28, Part I. Recommended Torque: 35 in-lbf (0.4 kg f-m) Maximum Torque: 50 in-lbf (0.57 kg f-m)
 2. Isolating material (ceramic) between hex (stud) and terminal No. 3 is beryllium oxide. Minimum isolation breakdown voltage is 2100 V rms for 1 minute duration.

92CS-23133R2

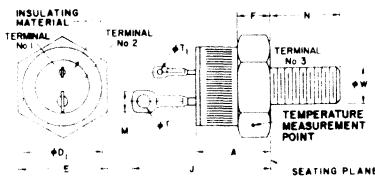
PRESS-FIT 25-, 30-, AND 40-A TRIACS



SYMBOL	INCHES		MILLIMETERS		NOTES
	MIN.	MAX.	MIN.	MAX.	
G	-	0.380	-	9.65	-
D	0.501	0.510	12.73	12.95	-
φD1	-	0.505	-	12.83	1
φD2	0.465	0.475	11.81	12.07	-
H	0.825	1.000	20.95	25.40	-
M	0.215	0.225	5.46	5.71	-
φT1	0.058	0.068	1.47	1.73	-
φT	0.138	0.148	3.51	3.75	-

- NOTE:
 1. Outer diameter of knurled surface.

STUD 6-, 10-, AND 15-A TRIACS; 20- AND 35-A SCR'S



SYMBOL	INCHES		MILLIMETERS		NOTES
	MIN.	MAX.	MIN.	MAX.	
A	0.330	0.505	8.40	12.80	-
φD1	-	0.544	-	13.81	-
E	0.544	0.562	13.82	14.28	-
F	0.113	0.200	2.87	5.08	-
J	-	0.950	-	24.13	-
M	-	0.155	-	3.94	-
N	0.422	0.453	10.72	11.50	-
φT1	0.058	0.068	1.47	1.73	-
φT	0.080	0.090	2.03	2.29	-
φW	1/4-28 UNF-2A	1/4-28 UNF-2A	1	1	1

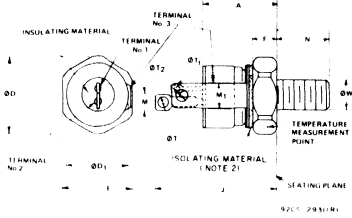
- NOTE 1.
 φW is pitch diameter of coated threads.
 REF: Screw Thread Standards for Federal Services, Handbook H28, Part I. Recommended Torque: 35 in-lbf (0.4 kg f-m) Maximum Torque: 50 in-lbf (0.57 kg f-m)

92CS-23135

WARNING: The ceramic used in these packages contains beryllium oxide. Do not crush, grind, or abrade these portions because the dust resulting from such action may be hazardous if inhaled. Disposal should be by burial.

Dimensional Outlines

ISOLATED-STUD 25-, 30-, and 40-A Triacs

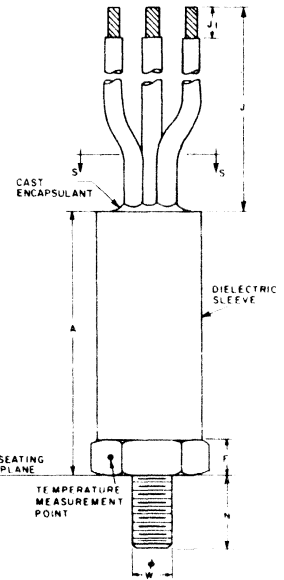
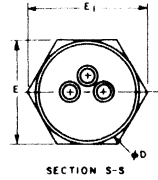


SYMBOL	INCHES		MILLIMETERS		NOTES
	MIN.	MAX.	MIN.	MAX.	
A	—	0.673	—	17.09	—
φD	0.604	0.614	15.34	15.59	—
φD ₁	0.501	0.505	12.72	12.82	—
E	0.551	0.557	13.99	14.14	—
F	0.100	0.185	2.50	4.69	—
J	—	1.298	—	32.96	—
M	0.210	0.230	5.33	5.84	—
M ₁	0.200	0.210	5.08	5.33	—
N	0.422	0.452	10.72	11.48	—
φT ₁	0.058	0.068	1.47	1.73	—
φT	0.138	0.148	3.50	3.75	—
φT ₂	0.138	0.148	3.50	3.75	—
φW	¼-28 UNF-2 A		¼-28 UNF-2 A		1

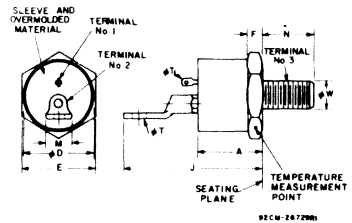
NOTES:

- φW is pitch diameter of coated threads. REF: Screw-Thread Standards for Federal Services, Handbook H28. Part I. Recommended Torque: 35 in-lbf (0.4 kg f-m). Maximum Torque: 50 in-lb (0.57 kg f-m).
- Isolating material (ceramic) between hex (stud) and terminal No. 3 is beryllium oxide. Minimum isolation breakdown voltage is 2100 V rms for 1 minute duration.

PRESS-FIT WITH FLEXIBLE LEADS, ENCAPSULATED ON ISOLATED-STUD



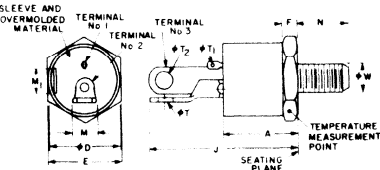
OVERMOLD STUD 60-A and 80-A Triacs 75-A and 100-A SCRs



SYMBOL	INCHES		MILLIMETERS		NOTE
	MIN.	MAX.	MIN.	MAX.	
A	0.7	0.8	17.78	20.32	1
φD	0.9	1.1	22.86	27.94	
E	1.050	1.060	26.67	26.92	
F	0.175	0.192	4.44	4.88	
J	—	1.75	—	44.45	
M	0.37	0.39	9.40	9.91	
N	0.73	0.77	18.54	19.56	
φT ₁	0.060	0.065	1.52	1.65	
φT	0.19	0.21	4.83	5.33	
φW	½-20 NF-2A		½-20 NF-2A		

- φW is pitch diameter of coated threads. REF: Screw-Thread Standards for Federal Services, Handbook H28, Part I. Recommended torque: 125 in-lb (1.44 kgf-m). Maximum torque: 150 in-lb (1.73 kgf-m).

OVERMOLD ISOLATED-STUD 60-A and 80-A Triacs 75-A and 100-A SCRs



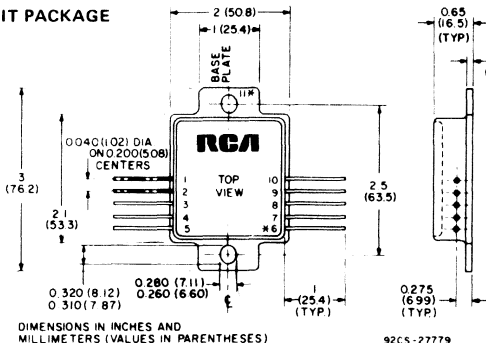
- φW is pitch diameter of coated threads. REF: Screw-Thread Standards for Federal Services, Handbook H28, Part I. Recommended torque: 125 in-lb (1.44 kgf-m). Maximum torque: 150 in-lb (1.73 kgf-m).
- Isolating material (ceramic) between hex (stud) and terminal No. 3 is beryllium oxide.

Symbol	INCHES		MILLIMETERS		Note
	Min.	Max.	Min.	Max.	
A	1.498	1.622	38.05	41.20	1
φD	0.619	0.629	15.72	15.98	
E	0.677	0.683	17.20	17.35	
E ₁	0.745	0.755	18.92	19.17	
F	0.117	0.123	2.97	3.12	
J	—	6.500	—	165.10	
J ₁	0.125	0.500	3.17	12.70	
N	0.430	0.450	10.92	11.43	
φW	1/4-28 UNF-2A		1/4-28 UNF-2A		

- Note 1: φW is pitch diameter of coated threads. Ref.: Screw-Thread Standard for Federal Services Handbook H28, Part I. Recommended torque: 35 in-lbf (0.4 kgf m).

92CM-26375

HYBRID-CIRCUIT PACKAGE



DIMENSIONS IN INCHES AND MILLIMETERS (VALUES IN PARENTHESES)

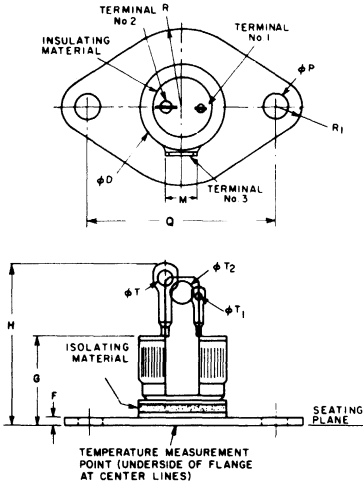
92CS-27779

- *For HC2000H, Terminal 11 is internally connected to Terminal 6.
For HC2500, Terminal 11 is electrically isolated from internal circuitry.

WARNING: The ceramic used in these packages contains beryllium oxide. Do not crush, grind, or abrade these portions because the dust resulting from such action may be hazardous if inhaled. Disposal should be by burial.

Dimensional Outlines

PRESS-FIT, ISOLATED ON TO-3 FLANGE FOR SCR's AND TRIACS FOR 25-A, 30-A, AND 40-A TRIACS; SEE NOTES 1 AND 2



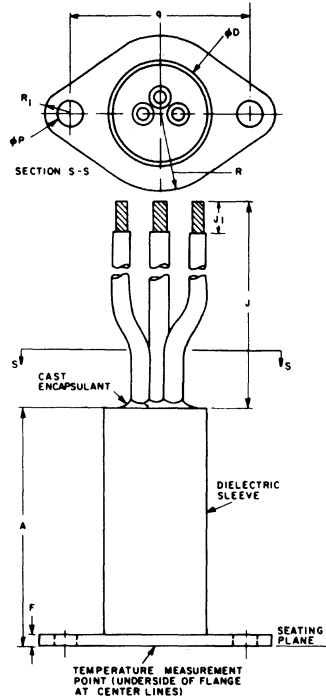
92CM-26377R2

SYMBOL	INCHES		MILLIMETERS		NOTES
	MIN.	MAX.	MIN.	MAX.	
G	—	0.635	—	16.13	
ϕD	—	0.510	—	12.95	
F	0.060	0.065	1.52	1.65	
H	—	1.015	—	25.78	
M	0.200	0.210	5.08	5.33	
Q	1.184	1.190	30.07	30.22	
ϕP	0.152	0.159	3.86	4.04	
R	0.497	0.503	12.62	12.77	
R_1	0.169	0.176	4.29	4.47	
ϕT	0.065	0.090	1.66	2.28*	1
ϕT_1	0.035	0.068	0.89	1.72	2
ϕT_2	0.138	0.148	3.50	3.76	

NOTES:

- For 25-A, 30-A, and 40-A triacs, $\phi T = 0.138-0.148$ in. (3.50-3.75 mm)
- For 25-A, 30-A, and 40-A triacs, $\phi T_1 = 0.068-0.068$ in. (1.47 - 1.73 mm)

PRESS-FIT WITH FLEXIBLE LEADS, ENCAPSULATED, ISOLATED ON TO-3 FLANGE



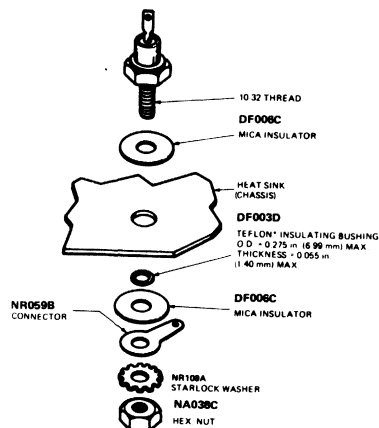
92CM-26376

Symbol	INCHES		MILLIMETERS	
	Min.	Max.	Min.	Max.
A	1.470	1.535	37.34	38.99
ϕD	0.619	0.629	15.72	15.98
F	0.060	0.065	1.52	1.65
J	—	6.500	—	165.10
J_1	0.125	0.500	3.17	12.70
q	1.184	1.190	30.07	30.22
ϕP	0.152	0.159	3.86	4.04
R	0.497	0.503	12.62	12.77
R_1	0.169	0.176	4.29	4.47

WARNING: The ceramic used in these packages contains beryllium oxide. Do not crush, grind, or abrade these portions because the dust resulting from such action may be hazardous if inhaled. Disposal should be by burial.

Suggested Hardware and Mounting Arrangements

DO-203MA/DO-4

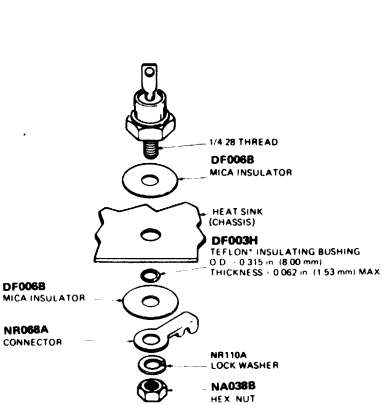


* REGISTERED TRADEMARK OF E. DUPONT DE NEMOURS & CO.

Maximum torque: 25 in.-lb (0.29 kgf-m)

92CS-27873

DO-203MB/DO-5

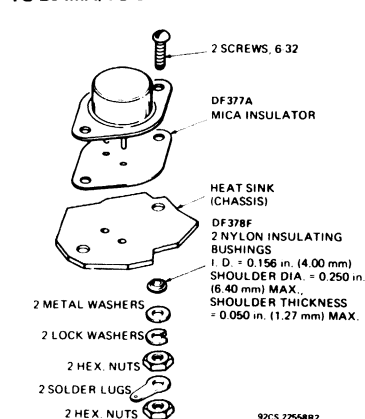


* REGISTERED TRADEMARK OF E. DUPONT DE NEMOURS & CO.

Maximum torque: 50 in.-lb (0.58 kgf-m)

92CS-2796

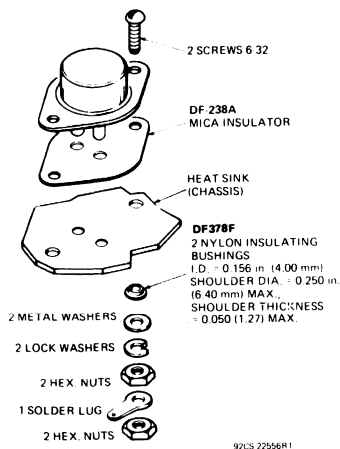
TO-204MA/TO-3



92CS-27558R2

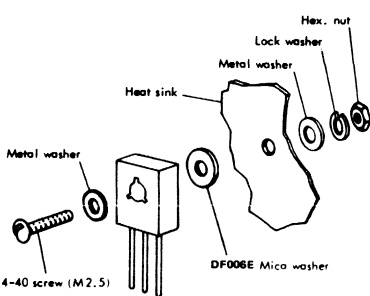
NOTE: MAXIMUM TORQUE APPLIED TO MOUNTING FLANGE IS 12 in.-lb (0.14 kgf-m)

MODIFIED TO-3



92CS-27568R1

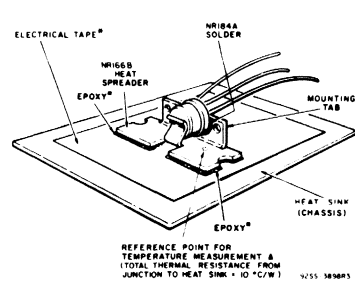
PLASTIC TO-5



Recommended torque (for even distribution of mounting pressure and optimum thermal contact): 6 lbs. in (0.07 kgf-m).

92CS-27763

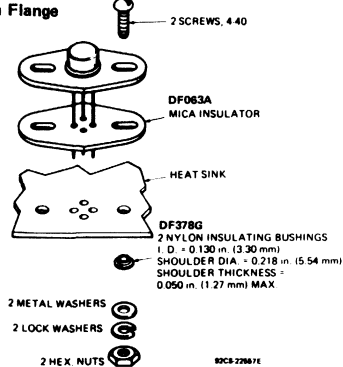
"LOW - Profile TO-5" with Heat Spreader



9255-18883

- * Scotch brand electrical tape No.27 (thermo setting one side), Minnesota Mining & Mfg. Co., St Paul, Minnesota, or equivalent.
- * An epoxy such as Hysol Epoxy Patch Kit 6C, Hysol Corporation, Olean, N. Y. 14761, or equivalent.
- * For heat-sink temperature measurement, the thermocouple (wire no larger than AWG No. 26) should be inserted in a small, shallow hole drilled in (but not through) the heat sink at the indicated temperature reference point.

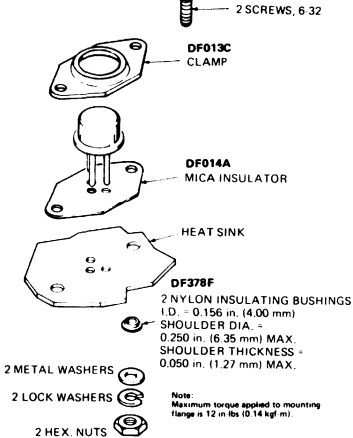
TO-205MA/TO-5 TO-205MD/TO-39 With Flange



92CS-27967

Note: Maximum torque applied to mounting flange is 8 in.-lb (0.09 kgf-m).

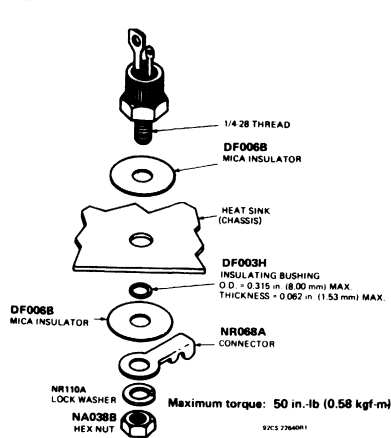
TO-8



Note: Maximum torque applied to mounting flange is 12 in.-lb (0.14 kgf-m).

92CS-27961R1

TO-208MA/TO-48

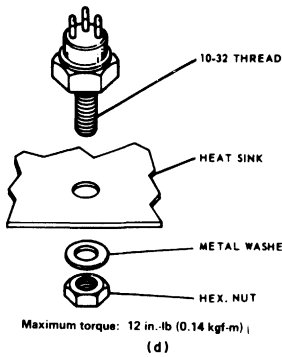


Maximum torque: 50 in.-lb (0.58 kgf-m)

92CS-27960R1

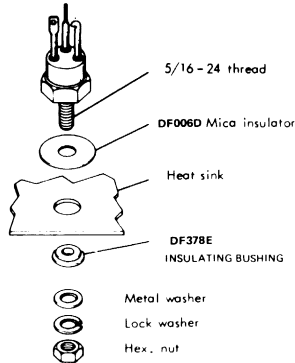
Suggested Hardware and Mounting Arrangements

TO-212MA/TO-60



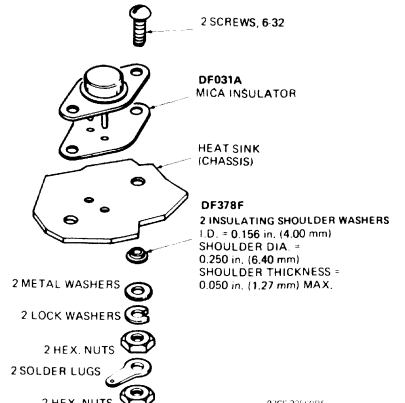
92CS-26378

TO-211MB/TO-63



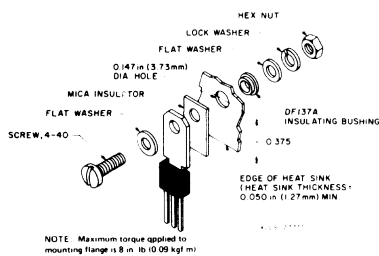
92CS-27781

TO-213MA/TO-66

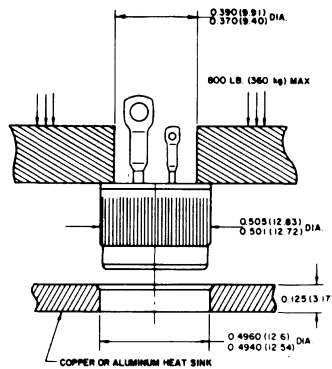


92CS-27685

TO-202AB

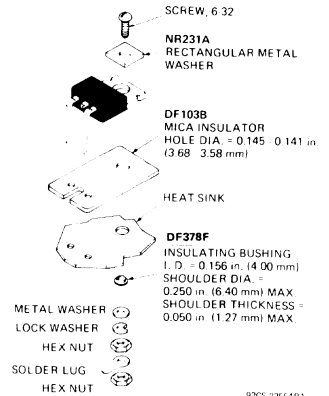


TO-203AA
6-, 10-, and 15-A Triacs, 20- and 35-A SCR's



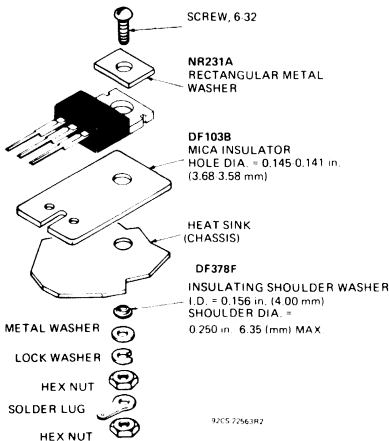
92CS-3018*2

TO-220AA



92CS-2264R1

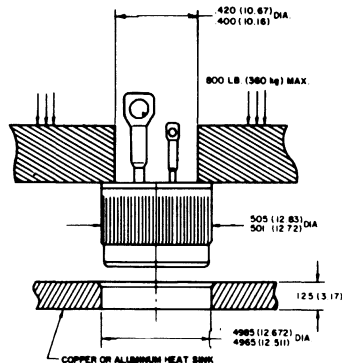
TO-220AB



92CS-2263R2

NOTE: MAXIMUM TORQUE APPLIED TO MOUNTING FLANGE IS 8 in.-lb (0.09 kgf-m)

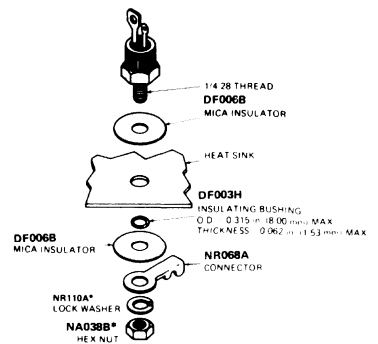
Press-Fit
25-, 30-, and 40-A Triacs



92LS-2284*5

NOTE: Dimensions in parentheses are in millimeters.

Stud and Isolated-Stud
Triacs and SCR's except 60- and 80-A Triacs

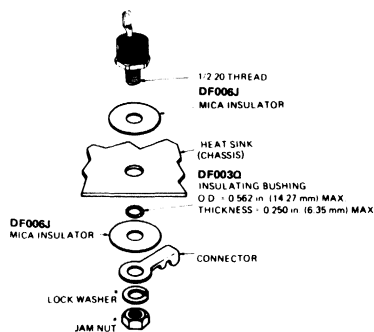


92LS-2256

* Only hardware required for isolated stud package
Maximum torque: 50 in.-lb (0.58 kgf m)

Suggested Hardware and Mounting Arrangements

Overmold Stud and Isolated-Stud 60- and 80-A Triacs 75-A and 100-A SCRs



* Only hardware required for isolated stud package.
Maximum torque: 150 in-lb (1.73 kgf-m) 92CS-22843A2

Case-to-Heat Sink Thermal Resistance for Different Mounting Arrangements - 60- and 80-A Triacs

Package	Type of Mounting Employed	Resistance-°C/W
Stud	Directly mounted on heat sink with or without the use of heat sink compound	0.05 to 0.15
Isolated Stud		

Case-to-Heat Sink Thermal Resistance for Different Mounting Arrangements- Triacs and SCR's except 60- and 80-A Triacs

Package	Type of Mounting Employed	Resistance-°C/W
Stud & Isolated-Stud	Directly mounted on heat sink with or without the use of heat-sink compound.	0.6
Stud	Mounted on heat sink with a 0.004 to 0.006 in. (0.102 to 0.152 mm) thick mica insulating washer used between unit and heat sink.	2.5
	Without heat sink compound	
	With heat sink compound	1.5

Case-to-Heat Sink Thermal Resistance for Different Mounting Arrangements- Triacs and SCR's except 60- and 80-A Triacs

Package	Type of Mounting Employed	Thermal Resistance-°C/W
Press-Fit	Press-fitted into heat sink. Minimum required thickness of heat sink = 1/8 in. (3.17 mm).	0.5
	Soldered directly to heat sink. (60-40 solder which has a melting point of 188°C should be used. Heating time should be sufficient to cause solder to flow freely).	0.1 to 0.35

Press-Fit Triacs and SCR's

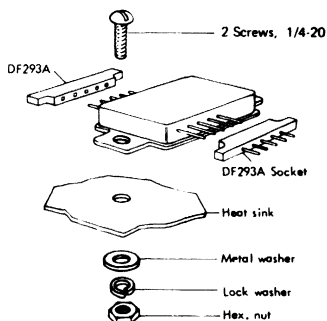
MOUNTING CONSIDERATIONS

Mounting of press-fit package types depends upon an interference fit between the thyristor case and the heat sink. As the thyristor is forced into the heat-sink hole, metal from the heat sink flows into the knurl voids of the thyristor case. The resulting close contact between the heat sink and the thyristor case assures low thermal and electrical resistances.

A recommended mounting method, Press-Fit (TO-203AA) or Press-Fit (25-, 30-, and 40-A triacs) shows press-fit knurl and heat-sink hole dimensions. If these dimensions are maintained, a "worst-case" condition of 0.0085 in. (0.2159 mm) interference fit will allow press-fit insertion below the maximum allowable insertion force of 800 pounds. A slight chamfer in the heat-sink hole will help center and guide the press-fit package properly into the heat sink. The insertion tool should be a hollow shaft having an inner diameter of 0.380 ± 0.010 in. (9.65 ± 0.254 mm) for PF-1 package, and 0.410 ± 0.010 in. (10.41 ± 0.254 mm) for PF-2 package and an outer diameter of 0.500 in (12.70 mm). These dimensions provide sufficient clearance for the leads and assure that no direct force will be applied to the glass seal of the thyristor.

The press-fit package is not restricted to a single mounting arrangement; direct soldering and the use of epoxy adhesives have been successfully employed. The press-fit case is tin-plated to facilitate direct soldering to the heat sink. A 60-40 solder should be used and heat should be applied only long enough to allow the solder to flow freely.

Power Hybrid Circuit Package

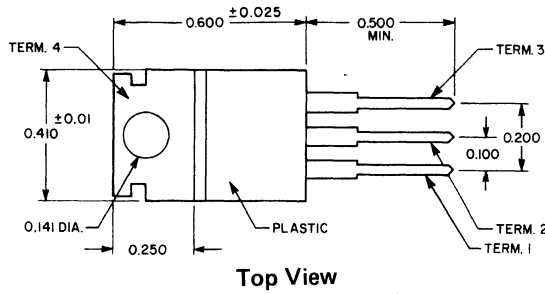


Note: Maximum torque applied to mounting flange is 24 in-lb (0.3 kgf-m).

DF293A is a socket to enable simple connection of this module
92CS-27782

Lead Forms for RCA Plastic Power Packages

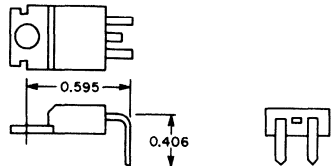
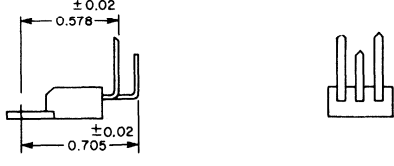
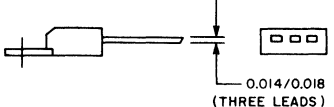
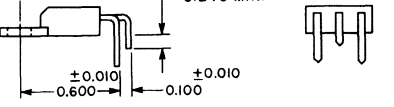
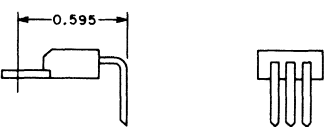
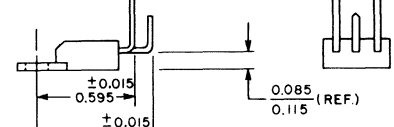
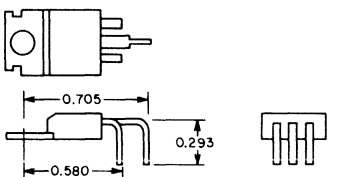
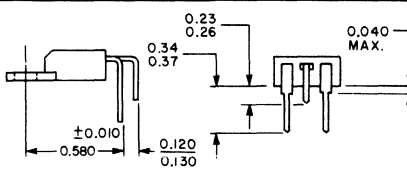
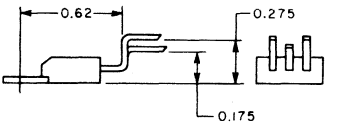
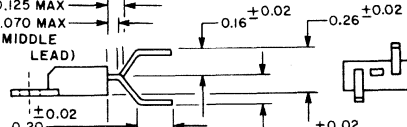
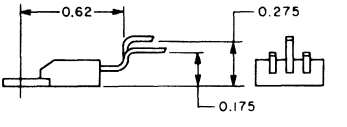
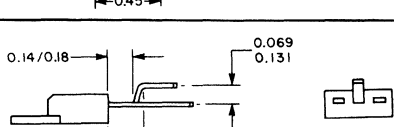
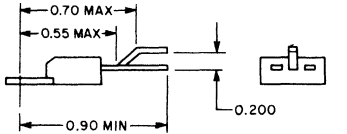
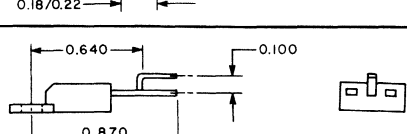
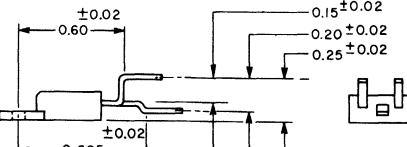
TO-220 (VERSAWATT)



Lead Form No.	Outline	Lead Form No.	Outline
6200		6206	
6201			
6202		6207	
6203		6209	
6204		6210	
6205		6211	
		6212	

Lead Forms for RCA Plastic Power Packages

TO-220 (VERSAWATT) [cont'd]

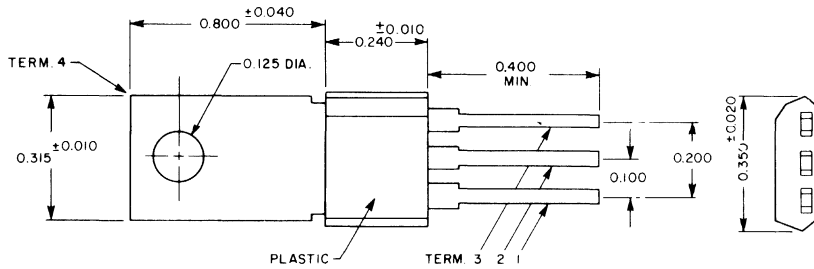
Lead Form No.	Outline		Outline
6216		6227	
6217		6231	
6220		6233	
6221		6234	
6223		6235	
6224		6237	
6226		6242	
		6245	

Lead Forms for RCA Plastic Power Packages

TO-220 (VERSAWATT) [cont'd]

Lead Form No.	Outline	Lead Form No.	Outline
6246		6248	
6247		6249	

TO-202 (VERSATAB)



Top View

Lead Form No.	Outline	Lead Form No.	Outline
Type 1		Type 3	
Type 11	<p> $a = \frac{0.110}{0.090}$ $b = 0.340 \text{ REF}$ $c = \frac{0.100}{0.080}$ </p>	Type 32	<p> $a = \frac{0.060}{0.030}$ $b = 0.520 \text{ REF}$ </p>
Type 12	<p> $a = \frac{0.060}{0.030}$ $b = 0.520 \text{ REF}$ </p>	Type 4	
Type 2		Type 41	<p> $a = \frac{0.420}{0.380}$ $b = 0.139 \text{ REF}$ </p>
Type 21	<p> $a = \frac{0.110}{0.090}$ $b = 0.340 \text{ REF}$ $c = \frac{0.100}{0.080}$ </p>		

Handling and Mounting of RCA Molded-Plastic Transistors and Thyristors

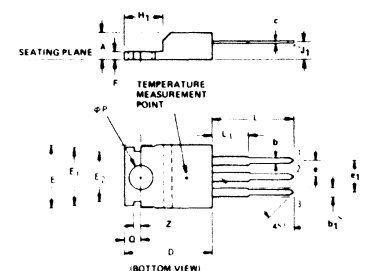
AN-4124

RCA power transistors and thyristors (SCR's and triacs) in VERSAWATT molded-silicone-plastic packages are specially designed for ease of use in a wide range of medium-power applications. This Note provides detailed guidelines for handling and mounting of these plastic-package devices, and shows different package options and suggested mounting hardware to accommodate various mounting arrangements. Recommendations are made for handling of the packages during the forming of leads to meet specific mounting requirements. Various mounting arrangements, thermal considerations, and cleaning methods are described. This information is intended to augment the data on electrical characteristics, safe operating area, and performance capabilities in the technical data bulletin for each type of plastic-package transistor or thyristor.

Package Options

Figs. 1 through 3 show the options currently available for devices in RCA VERSAWATT (JEDEC TO-220) packages. The JEDEC Type TO-220AB in-line-lead version, shown in Fig. 1,

represents the basic style. This configuration features leads that can be formed to meet a variety of specific mounting requirements. Fig. 2 shows a package configuration that allows a VERSAWATT package to be mounted on a printed-circuit board with a 0.100-inch grid and a minimum lead spacing of 0.200 inch. Fig. 3 shows a JEDEC Type TO-220AA version of the VERSAWATT package. The dimensions of this type of transistor package are such that it can replace the JEDEC TO-66 transistor package in a commercial socket or printed-circuit board without retooling.

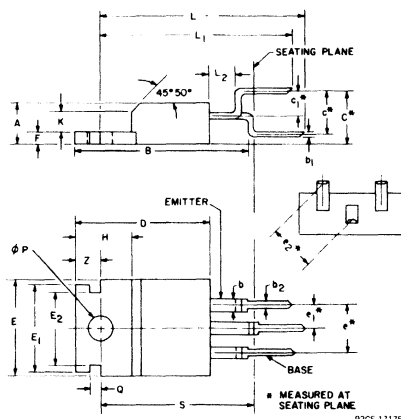


SYMBOL	INCHES		MILLIMETERS		NOTES
	MIN.	MAX.	MIN.	MAX.	
A	0.140	0.190	3.56	4.82	-
b	0.020	0.045	0.51	1.14	-
b1	0.045	0.070	1.14	1.77	-
c	0.015	0.025	0.38	0.63	-
D	0.560	0.625	14.23	15.87	-
E	0.380	0.420	9.66	10.66	1
E1	0.365	0.385	9.28	9.77	-
E2	0.300	0.320	7.62	8.12	-
e	0.090	0.110	2.29	2.79	2
e1	0.190	0.210	4.83	5.33	2
F	0.045	0.055	1.14	1.39	-
H1	0.230	0.270	5.85	6.85	1
J1	0.080	0.115	2.04	2.92	-
L	0.500	0.582	12.70	14.27	-
L1	-	0.250	-	6.35	-
phi P	0.139	0.147	3.531	3.733	-
Q	0.100	0.120	2.54	3.04	-
Z	0.040	0.060	1.02	1.52	-

92CS-17991R2

NOTES:
1. Tab contour optional within H₁ and E.
2. Position of lead to be measured 0.250 - 0.255 in. (6.350 - 6.477 mm) from case

Fig. 1 - Dimensional outline of the JEDEC TO-220AB in-line-lead VERSAWATT package.

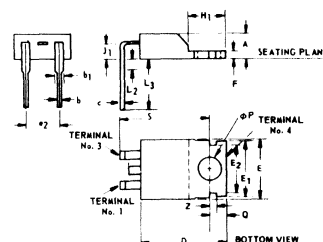


SYMBOL	INCHES		MILLIMETERS		NOTES
	MIN.	MAX.	MIN.	MAX.	
A	0.140	0.190	3.56	4.82	-
B	-	0.850	-	21.59	-
b	0.045	0.070	1.15	1.17	-
b1	0.015	0.030	0.382	0.762	-
b2	0.020	0.038	0.508	0.965	-
C	0.230	0.270	5.85	6.85	-
c	0.180	0.220	4.58	5.58	-
c1	0.130	0.170	3.31	4.31	-
D	0.560	0.625	14.23	15.87	-
E	0.380	0.420	9.66	10.66	1
E1	0.365	0.385	9.28	9.77	-
E2	0.300	0.320	7.62	8.12	-
e	0.190	0.210	4.83	5.33	-
e1	0.090	0.110	2.29	2.79	-
e2	0.203	0.243	5.16	6.17	-
F	0.045	0.055	1.15	1.39	-
H	0.230	0.270	5.85	6.85	1
K	0.080	0.085	2.032	2.159	-
L	0.993	1.033	25.22	26.23	-
L1	0.895	0.935	22.73	23.74	-
L2	0.070	0.090	1.78	2.28	-
phi P	0.139	0.147	3.531	3.734	-
Q	0.040	0.060	1.02	1.52	-
S	0.655	0.685	16.64	17.39	-
Z	0.100	0.120	2.54	3.04	-

92CS-17175

NOTES:
1. Tab contour optional within H and E.

Fig. 2 - Dimensional outline of VERSAWATT package designed for mounting on printed-circuit boards.



SYMBOL	INCHES		MILLIMETERS		NOTES
	MIN.	MAX.	MIN.	MAX.	
A	0.140	0.190	3.56	4.82	-
b	0.020	0.045	0.51	1.14	-
b1	0.045	0.070	1.14	1.77	-
c	0.015	0.025	0.38	0.63	-
D	0.560	0.625	14.23	15.87	-
E	0.380	0.420	9.66	10.66	1
E1	0.365	0.385	9.28	9.77	-
E2	0.300	0.320	7.62	8.12	-
e	0.190	0.210	4.83	5.33	2
F	0.045	0.055	1.14	1.39	-
H1	0.230	0.270	5.85	6.85	1
J1	0.080	0.115	2.04	2.92	-
L2	-	0.050	-	1.27	-
L3	0.360	0.422	9.15	10.71	-
phi P	0.139	0.147	3.531	3.733	-
Q	0.100	0.120	2.54	3.04	-
S	0.580	0.610	14.74	15.49	-
Z	0.040	0.060	1.02	1.52	-

92CS-17990R2

NOTES:
1. Tab contour optional within H₁ and E.
2. Position of lead to be measured 0.050 - 0.055 in. (1.270 - 1.397 mm) below seating plane.

Fig. 3 - JEDEC TO-220AA VERSAWATT package designed for direct replacement of the JEDEC TO-66 package.

The pin-connection arrangement of thyristors supplied in TO-220AA packages, however, differs from that of thyristors supplied in conventional TO-66 packages so that some hardware changes are required to effect a replacement.

Lead-Forming Techniques

RCA VERSAWATT plastic packages are both rugged and versatile within the confines of commonly accepted standards for such devices. Although these versatile packages lend themselves to numerous arrangements, provision of a wide variety of lead configurations to conform to the specific requirements of many different mounting arrangements is highly impractical. However, the leads of the VERSAWATT in-line package can be formed to a custom shape, provided that they are not indiscriminately twisted or bent. Although these leads can be formed, they are not flexible in the general sense, nor are they sufficiently rigid for unrestrained wire wrapping.

AN-4124

Before an attempt is made to form the leads of an in-line package to meet the requirements of a specific application, the desired lead configuration should be determined, and a lead-bending fixture should be designed and constructed. The use of a properly designed fixture for this operation eliminates the need for repeated lead bending. When the use of a special-bending fixture is not practical, a pair of long-nosed pliers may be used. The pliers should hold the lead firmly between the bending point and the case, but should not touch the case. Fig. 4 illustrates the use of long-nosed pliers for lead bending. Fig. 4(a) shows techniques that should be avoided; Fig. 4(b) shows the correct method.

When the leads of an in-line plastic package are to be formed, whether by use of long-nosed pliers or a special bending fixture, the following precautions must be observed to avoid internal damage to the device:

1. Restrain the lead between the bending point and the plastic case to prevent relative movement between the lead and the case.
2. When the bend is made in the plane of the lead (spreading), bend only the narrow part of the lead.
3. When the bend is made in the plane perpendicular to that of the leads, make the bend at least 1/8 inch from the plastic case.
4. Do not use a lead-bend radius of less than 1/16 inch.
5. Avoid repeated bending of leads.

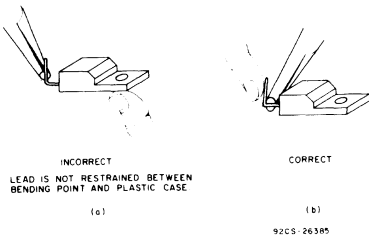


Fig. 4 - Use of long-nosed pliers for lead bending: (a) incorrect method; (b) correct method.

The leads of the TO-220AB VERSAWATT in-line package are not designed to withstand excessive axial pull. Force in this direction greater than 4 pounds may result in permanent damage to the device. If the mounting arrangement tends to impose axial stress on the leads, some method of strain relief should be devised. Fig. 2 illustrates an acceptable lead-forming method that provides this relief.

Wire wrapping of the leads is permissible, provided that the lead is restrained between the plastic case and the point of the wrapping. Soldering to the leads is also allowed; the maximum soldering temperature, however, must not exceed 235°C and must be applied for not more than 10 seconds at a distance greater than 1/8 inch from the plastic case. When wires are used for connections, care should be exercised to assure that movement of the wire does not cause movement of the lead at the lead-to-plastic junctions.

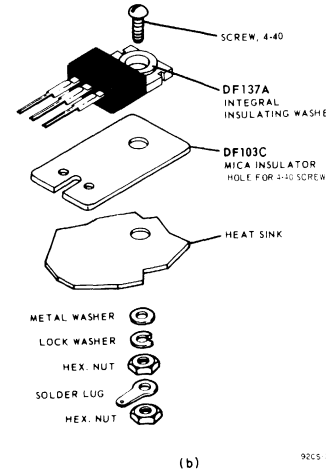
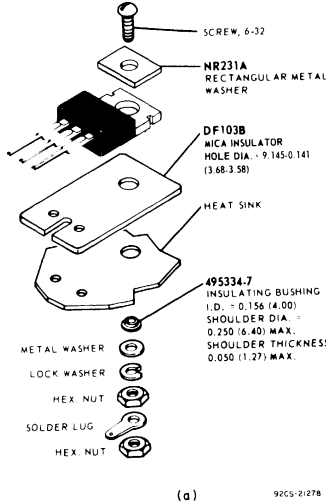


Fig. 5 - Methods of mounting JEDEC TO-220AB in-line-lead version of RCA VERSAWATT transistors and thyristors.

Mounting

Figs. 5 through 8 show recommended mounting arrangements and suggested hardware for the VERSAWATT transistors. The rectangular washer (NR231A) shown in Fig. 5(a) is designed to minimize distortion of the mounting flange when the transistor is fastened to a heat sink. Excessive distortion of the flange could cause damage to the transistor. The washer is particularly important when the size of the mounting hold exceeds 0.140 inch (6-32 clearance). Larger holds are needed to accommodate insulating bushings; however, the holds should not be larger than necessary to provide hardware clearance and, in any case, should not exceed a diameter of 0.250 inch. Flange distortion is also possible if excessive torque is used during mounting. A maximum torque of 8 inch-pounds is specified. Care should be exercised to assure that the tool used to drive the mounting screw never comes in contact with the plastic body during the driving operation. Such contact can result in damage to the plastic body and internal device connections. An excellent method of avoiding this problem is to use a spacer or combination spacer-isolating bushing which raises the screw head or nut above the top surface of the plastic body, as shown in Fig. 8. The material used for such a spacer or spacer-isolating bushing should, of course, be carefully selected to avoid "cold flow" and consequent reduction in mounting force. Suggested materials for these bushings are diallphthalate, fiberglass-filled nylon, or fiberglass-filled polycarbonate. Unfilled nylon should be avoided.

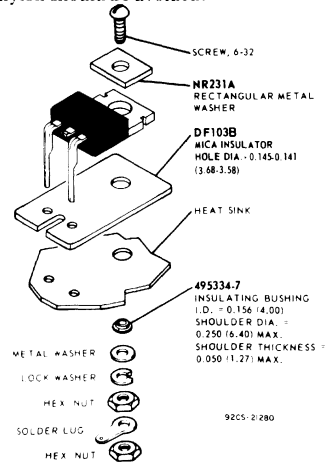


Fig. 6 - Chassis mounting of JEDEC TO-220AA version of RCA VERSAWATT devices.

AN-4124

Modification of the flange can also result in flange distortion and should not be attempted. The package should not be soldered to the heat sink by use of lead-tin solder because the heat required with this type of solder will cause the junction temperature of the package to become excessive.

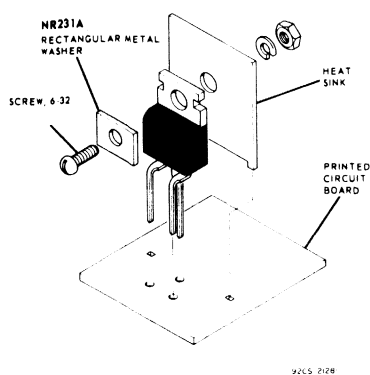


Fig. 7 - Method of mounting RCA VERSAWATT packages on printed-circuit boards.

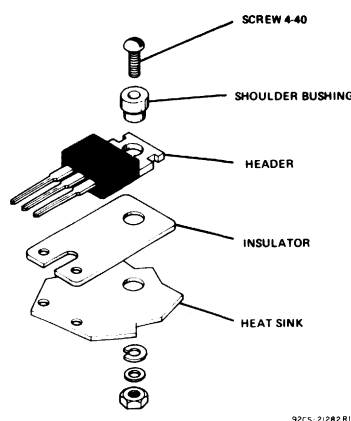


Fig. 8 - Mounting arrangements in which an isolating bushing is used to raise the head of the mounting screw above the plastic body of the VERSAWATT package.

The TO-220AA plastic package can be mounted in commercially available TO-66 sockets, such as UID Electronics Corp. Socket No. PTD-4 or equivalent. For testing purposes, the TO-220AB in-line package can be mounted in a Jetron Socket No. CD74-104 or equivalent. Regardless of the mounting method, the following precautions should be taken:

1. Use appropriate hardware.
2. Always fasten the transistor to the heat sink before the leads are soldered to fixed terminals.
3. Never allow the mounting tool to come in contact with the plastic case.
4. Never exceed a torque of 8 inch-pounds.
5. Avoid oversize mounting holes.
6. Provide strain relief if there is any probability that axial stress will be applied to the leads.
7. Use insulating bushings to prevent hot-creep problems. Such bushings should be made of diallphthalate, fiberglass-filled nylon, or fiberglass-filled polycarbonate.

Thermal-Resistance Considerations

The maximum allowable power dissipation in a solid-state device is limited by its junction temperature. An important factor to assure that the junction temperature remains below the specified maximum value is the ability of the associated thermal circuit to conduct heat away from the device.

When a solid-state device is operated in free air, without a heat sink, the steady-state thermal circuit is defined by the junction-to-free-air thermal resistance given in the published data on the device. Thermal considerations require that there be a free flow of air around the device and that the power dissipation be maintained below that which would cause the junction temperature to rise above the maximum rating. When the device is mounted on a heat sink, however, care must be taken to assure that all portions of the thermal circuit are considered.

Fig. 9 shows the thermal circuit for a heat-sink-mounted transistor. This figure shows that the junction-to-ambient thermal circuit includes three series thermal-resistance components, i.e., junction-to-case, $R_{\theta JC}$; case-to-heat-sink, $R_{\theta CS}$; and heat-sink-to-ambient, $R_{\theta SA}$. The junction-to-case thermal resistance of the various device types is given in the individual technical bulletins on specific types. The heat-sink-to-ambient thermal resistance can be

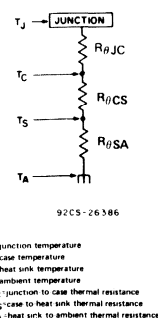


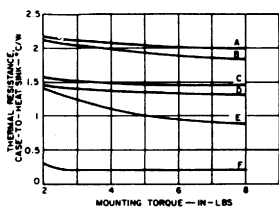
Fig. 9 - Thermal equivalent circuit for a transistor mounted on a heat sink.

determined from the technical data provided by the heat-sink manufacturer, or from published heat-sink nomographs. The case-to-heat-sink thermal resistance depends on several factors, which include the condition of the heat-sink surface, the type of material and thickness of the insulator, the type of thermal compound, the mounting torque, and the diameter of the mounting hold in the heat-sink.

Fig. 10 shows a set of curves of typical case-to-heat-sink thermal resistance of the VERSAWATT package as a function of mounting torque for several mounting arrangements. Curves A through D show typical case-to-heat-sink thermal resistance for the mounting arrangements shown in Fig. 5. Curves E and F are representative of a VERSAWATT package mounted over a heat-sink mounting hold that has a diameter of 0.140 inch (No. 6 screw clearance). Curve E shows the wide variation in thermal resistance with torque when the transistor is mounted dry. Curve F shows the effect on contact thermal resistance of a thin layer of Dow Corning No. 340 silicone grease applied between transistor and heat sink. For torques within the recommended range of 4 to 8 inch-pounds, contact thermal resistance is reduced to between 18 and 25 per cent of the dry values.

Operation of the transistor with heat-sink temperatures of 100°C or greater results in some shrinkage of the insulating bushing normally used to mount power transistors and thyristors. The degradation of contact thermal resistance (refer to Fig. 10) is usually less than 25 per cent if a good thermal compound is used.

AN-4124



CURVE	MOUNTING ARRANGEMENT FIGURE	HEAT SINK HOLE DIA. (IN.)	MICA THICKNESS (MILS)	THERMAL COMPOUND
A	5 (a)	.250	4	Dow Corning No.340
B	5 (b)	.113	4	Dow Corning No.340
C	5 (a)	.250	2	Dow Corning No.340
D	5 (b)	.113	2	Dow Corning No.340
E	—	.140	None	None
F	—	.140	None	Dow Corning No.340

Fig. 10 — Typical case-to-heat-sink thermal resistance as a function of mounting torque for an RCA VERSAWATT package.

During the mounting of RCA molded-plastic solid-state power devices, the following special precautions should be taken to assure efficient heat transfer from case to heat sink:

1. Mounting torque should be between 4 and 8 inch-pounds.
2. The mounting holes should be kept as small as possible.
3. Holes should be drilled or punched clean with no burrs or ridges, and chamfered to a maximum radius of 0.010 inch.
4. The mounting surface should be flat within 0.002 inch/inch.
5. Thermal grease (Dow Corning 340 or equivalent) should always be used (on both sides on the insulating washer if one is employed).
6. Thin insulating washers should be used (thickness of factory-supplied mica washers ranges from 2 to 4 mils).
7. A lock washer or torque washer should be used, together with materials that have sufficient creep strength to prevent degradation of heat-sink efficiency during life.

Cleaning After Mounting

A wide variety of solvents is available for degreasing and flux removal. The usual practice is to submerge components in a solvent bath for a specified time. From a reliability standpoint, however, it is extremely important that the solvent, together with other chemicals in the solder-cleaning system (such as flux and

solder covers), not adversely affect the life of the component. This consideration applies to all non-hermetic and molded-plastic components.

It is, of course, impractical to evaluate the effect on long-term transistor life of all cleaning solvents, which are marketed under a variety of brand names with numerous additives. These solvents can, however, be classified with respect to their component parts, as either acceptable or unacceptable. Chlorinated solvents tend to dissolve the outer package and, therefore, make operation in a humid atmosphere unreliable. Gasoline and other hydrocarbons cause the inner encapsulant to swell and damage the package. Alcohols are acceptable solvents and are recommended for flux removal whenever possible. Examples of suitable alcohols are methanol, isopropanol, and special denatured ethyl alcohols, such as SDA1, SDA30, SDA34, and SDA44.

When considerations such as solvent flammability are of concern, selected freon-alcohol blends are usable when exposure is limited. Solvent such as the following should be safe for normal flux-removal operations, but care should be taken to assure their suitability in the cleaning procedure:

Freon TE
 Freon TE-35
 Freon TP-35 (Freon PC)

The solvents may be used for a maximum of 4 hours at 25°C or for a maximum of 1 hour at 50°C.

Care must also be used in the selection of fluxes in the soldering of leads. Rosin or activated rosin fluxes are recommended, while organic or acid fluxes are not. Examples of acceptable fluxes are:

Alpha Reliaros No. 320-33
 Alpha Reliaros No. 346
 Alpha Reliaros No. 711
 Alpha Reliafoam No. 807
 Alpha Reliafoam No. 809
 Alpha Reliafoam No. 811-13
 Alpha Reliafoam No. 815-35
 Kester No. 44

If the completed assembly is to be encapsulated, the effect on the molded-plastic transistor must be studied from both a chemical and a physical standpoint.

Note:

Silicone-oil fluids that come into direct physical contact with the molded-plastic packages may react chemically with and cause damage to the packages. Such fluids, therefore, are unacceptable as baths for degreasing and flux removal. Silicone oils contained in thermal compounds or other materials used in mounting the molded-plastic packages, however, do not cause damage to the packages provided the bleed rate of such materials is not excessive. For example, in mounting arrangements that employ an insulating washer, a thermal-grease heat-sink compound, such as Dow Corning No. 340 or equivalent, for which the bleed rate does not exceed 0.5 per cent after 24 hours at 200°C is recommended for use on both sides of the insulating washer.

Application Note Abstracts

Power Transistors

AN-3565 4 pages
A 100-Watt, 18-KHz Inverter Using RCA-2N5202 Silicon Power Transistors

A two-transistor, two transformer inverter that demonstrates the excellent switching capabilities of the RCA-2N5202 power transistor is described.

AN-4124 8 pages
Handling and Mounting of RCA Molded-Plastic Transistors and Thyristors

Detailed guidelines for handling and mounting plastic-packaged RCA power transistors and thyristors are given. Types of packages and suggested mounting hardware to accommodate various mounting arrangements are described. Recommendations are made for handling packages during the forming of leads. Various mounting arrangements, thermal considerations, and cleaning methods are described. This information is intended to supplement the data on electrical characteristics, safe operating area, and performance capabilities in the technical bulletin for each type of plastic-packaged transistor or thyristor.

AN-4509 8 pages
Compact 5-Volt Power Supplies Using High-Voltage Power Transistors

The use of low-cost, industrial-type, high voltage power transistors and fast-recovery rectifiers to achieve size and weight reductions and efficiency improvements in 5-volt dc power supplies with output currents of 50 amperes or more are discussed. The supplies described, like those used in high-reliability aerospace applications, use switching rather than dissipating regulators to eliminate the need for a 60-Hz power transformer and heat sinks for the transistors. A complete switching-regulator power supply is described in detail.

AN-4558 12 pages

A regulated constant-voltage power supply that uses integrated circuits and a rugged homotaxial-base transistor to attain high output-power capability is described. A 20-volt, 3-ampere supply that uses a single RCA-2N3055 pass transistor is described in detail; the discussion includes circuit descriptions, operating characteristics, component specifications, and suggestions for layout and construction. Thermal-fatigue effects and safe operating conditions for power transistors are considered. Guidance is provided for those who may want to develop a similar circuit.

AN-4573 6 pages
Testing for Forward-Bias Second Breakdown in Power Transistors

The design of a non-destructive forward-bias second-breakdown test facility that determines the forward-bias second-breakdown safe-operating locus for power transistors is described. Detailed schematic diagrams of test circuits that can be used to test devices with collector-current ratings up to 2.5 amperes and sustaining collector-to-emitter voltage [$V_{CEO}(sus)$] ratings

up to 300 volts, or with ratings to 5 amperes and 100 volts, are given.

AN4612 4 pages
Thermal-Cycling Rating System for Silicon Power Transistors

The basic causes of thermal fatigue in silicon power transistors are analyzed, and a rating chart that makes it possible for a circuit designer to avoid such failures during the operating life of his equipment is described. Examples are provided on the use of this chart to determine the transistor operating conditions required to assure a desired thermal-cycling capability and to determine whether the thermal-cycling capability is adequate for the requirements of a given application.

AN-4673 6 pages
A 750-Watt Three-Phase Frequency Converter

A frequency converter with an output frequency ranging from 380 Hz to 1250 Hz that delivers up to 750 watts of three-phase power at 120 or 208 volts rms is described. The circuit, useful in military equipment that uses three phase, 400-Hz power, and industrial plants and laboratories that require power at a variety of low frequencies, makes use of a three-phase bridge inverter supplied from a rectified line; the input can be single-phase or three-phase, 120 volts or 208 volts, at any frequency from 47 Hz to 1250 Hz. The RCA-2N5805 power transistor is used in the circuit.

AN-4783 8 pages
Thermal-Cycling Ratings of Power Transistors

A testing program used to determine the capability of the design of an RCA-2N3055 power transistor to withstand thermal cycling over a wide range of operating conditions is described. A sufficient number of tests were performed to verify a rating chart that can be applied by an equipment designer to any practical operating condition. The discussion covers a brief description of thermal fatigue, a method of "scaling the environment" to determine the proper test conditions, specialized test equipment and techniques that assure that the proper stresses were applied to the transistor, and the test results and predicted-capability chart for the transistor.

AN-6145 8 pages
A Test Set for Nondestructive Safe-Area Measurements Under High-Voltage, High-Current Conditions

The determination of the safe-operating area of power transistors at high volt/ampere products under pulsed and repetitive-pulsed conditions, nondestructively, is made possible by the test set described in this Note. System philosophy, design, construction, and operation are detailed.

AN-6163 12 pages
Quantitative Measurement of Thermal-Cycling Capability of Silicon Power Transistors

This Note discusses the methods used to test the thermal-cycling capability of power

transistors. A brief description of thermal fatigue, application requirements, and rating charts is given. A detailed discussion of the practical design and construction of thermal-cycling racks is also included along with actual test conditions for various power transistor types. Acceleration factors, failure indicators, failure mechanisms, and real-time control of thermal-cycling capability of factory products are discussed. Some information is also given on hermetic versus plastic-package thermal-cycling reliability.

AN-6195 8 pages
A Switching Regulator Using An RCA p-n-p Power Darlington Transistor

A 20-kHz switching regulator that employs an RCA8350B, a p-n-p Darlington transistor, and that operates from a 28-volt supply is described. The regulator has a regulated output between 4 and 16 volts dc and features overload protection that limits the current to about 11 amperes. The regulator does not operate at a fixed clock frequency, but is free-running.

AN-6215 6 pages
Interpretation of Voltage Ratings for Transistors

The basic voltage-breakdown mechanisms of power transistors and the relationship of these mechanisms to external circuits are described—transistor voltage breakdown is a function of both individual device characteristics and associated circuits. The mechanisms described are used to explain the various types of voltage ratings used by transistor manufacturers.

AN-6249 6 pages
Real-Time Controls of Silicon Power-Transistor Reliability

This Note compares the traditional, classical approach to the reliability-assurance testing of power transistors with a newer classification of testing: Real-Time Control, RTC. The classical approach is commonly referred to as Group B, and involves a series of mechanical, environmental, and life stress tests. RTC involves a continuous, systematic evaluation and control in "real time" of basic, potential failure mechanisms. It is an important supplement to a total program of reliability assurance.

AN-6272 6 pages
Characteristics of RCA Monolithic Power Darlington

The design and application of RCA monolithic power Darlington transistors is described. The Darlington circuit has been in use for some time in applications where high beta is needed, but has only recently been available as a monolithic device. The RCA Power Darlington series 2N6385 consists of n-p-n circuits that can be driven directly from an integrated circuit and that operate at currents up to 10 amperes and voltages ranging from 40 to 80 volts.

Application Note Abstracts

AN-6281 6 pages
Accurate Measurement of Sustaining Voltage of Power Transistors — A Pulsed-Breakdown Test Set

Several techniques for the measurement of the primary (sustaining) breakdown voltage of power transistors are in common use today. The characteristics and limitations of these test methods frequently make rapid and accurate sustaining-voltage readings on power transistors difficult or impossible. The test set described in this Note fills the need for accurate, laboratory-type, sustaining-voltage measuring equipment, although circuitry used in the test set design may be adapted to high-speed testing equipment as well. A complete parts list and calibration sequence are given.

AN-6297 2 pages
Biassing Circuit for the Output Stage of a Power Amplifier — The V_{BE} Multiplier

A biasing circuit, the V_{BE} multiplier, for the output stage of a power amplifier is described. The V_{BE} multiplier provides proper bias for the output transistors of the amplifier under all operating conditions.

AN-6320 8 pages
Radiation-Hardness Capability of RCA Silicon Power Transistors

The types of radiation damage that might be experienced by a power device and the tests used to determine the design most effective in preventing these types of damage are described.

AN-6330 12 pages
A Safe-Area Rating System for Power Inverters Handling Capacitive and Inductive Loads

Although transistor power inverters have classically been evaluated with resistive loads, the reliability of practical inverters often depends on inductive and capacitive loads and associated starting transient considerations. This Note describes a safe-area rating system for transistors and relates this system to self-excited single-transformer, self-excited double transformer, and driven inverters operating into resistive, capacitive, and inductive loads under both steady-state and starting conditions.

AN-6400 16 pages
Operating Conditions Experienced by Transistors in TV Horizontal-Deflection Circuits

This Note is a compilation of equations used to calculate the operating conditions experienced by the output transistor in various types of deflection circuits, circuits that provide horizontal (line) deflection of the electron beam in TV picture tubes employing magnetic deflection yokes. The circuits treated include direct-drive circuits and those in which taps and auxiliary windings on the flyback transformer are employed to provide impedance transformation and yoke voltage reduction. Derivations of the various equations, the simplified as well as the rigorous forms, are provided in Appendixes. Relationships for calculating the "worst case" voltage conditions are given. Operating conditions as measured in experimental circuits are compared with those calculated by means of the equations provided in this Note.

AN-6432 8 pages
2-Kilowatt Stepped Sine-Wave Inverter

Recent advances in high-power semiconductor technology, complemented by the capabilities of existing digital integrated circuits, have made possible the economical design of a stepped sine-wave inverter in the multikilowatt range. This Note describes the use of the 2N578 power transistor in a 2-kilowatt, 60-Hz, stepped sine-wave inverter.

AN-6423 8 pages
Thirty-Watt (RMS) True Complementary — Symmetry Audio Amplifier Using BDX33 and BDX34 Darlington Transistors

Monolithic-silicon Darlington transistors designed for low- and medium-frequency power applications are especially suitable for audio-output applications. This Note describes the design and performance of an audio amplifier that incorporates such devices.

AN-6425 8 pages
Automatic Analyzer for Determining Safe Operating Area of Power Transistors

The safe operating area is one of the most important ratings of a power transistor, yet only a few methods exist to evaluate it. The method presented in this Note allows description of the safe operating area for both dc and pulse operation without subjecting the transistor to breakdown. Both n-p-n and p-n-p transistors in hermetic or plastic packages can be evaluated, and the complete safe-area curve can be automatically described in a short time.

AN-6605 16 pages
Application of RCA Power Devices in Off-Line, High-Frequency Inverter/Converter Circuits

The current trend in power inverter/converter design is to use high-frequency switching techniques and direct operation off the available utility lines (i.e., 110 or 220 volts). The use of higher operating frequencies reduce the magnetic materials required and the size of the filter capacitors. This Note discusses the use of RCA power transistors and SCR's in selected high-frequency inverter/converter applications.

AN-6624 16 pages
Voltage Limitations of Power Transistors

This Note summarizes the primary factors that determine the voltage limitations of power transistors used in common-emitter circuits with typical base-to-emitter circuit terminations. The material presented defines terms and the various operating regions of the transistor as shown in typical volt-ampere characteristics, develops the analytic relations defining operation in each of the regions, and relates each of the operating regions to the physical actions taking place within the transistor structure.

AN-6741 8 pages
RCA 15-Ampere SwitchMax Power Transistors in a 340-Watt 20kHz Flyback Converter

This Note describes the use of the RCA 2N6676, a 15-ampere SwitchMax power transistor, as a driven pulse-width-modulated flyback-converter stage, the final power-output stage, in a 20-kHz off-line power converter that

provides 340 watts of output power. Adjunct circuitry, such as the driver stage, reverse-bias amplifier, and overvoltage and overcurrent protection circuits, are also discussed.

RF/Microwave Power Transistors

AN-3749 6 pages
40-Watt Peak-Envelope-Power Transistor Amplifier for AM Transmitters in the Aircraft Band (118 to 136 MHz)

A broadband amplifier for use in AM transmitters operating in the aircraft communication band (118 to 136 MHz) is described. The uncomplicated design of the unit leaves ample room for adaptation to specific needs. The amplifier is capable of delivering peak envelope power of 40 watts at a modulation of 95 per cent with a collector voltage of 12.5 volts dc. Unmodulated drive of 5 milliwatts is required at the input. The overall efficiency of the amplifier is 48 to 53 per cent and the envelope distortion is less than 5 per cent for an amplitude modulation of 95 per cent.

AN-6683 6 pages
6- and 12-Volt 4-W Transmitters for Class D Citizens Band Radio-Telephony Using the RCA-2N6670

This Note acquaints the reader with basic principles of amplitude modulation (AM), circuit and transistor design and performance considerations, and introduces the RCA-2N6670, a reliable rf output transistor for 6-V or 12.5-V CB transmitter applications.

Power Hybrid Circuits

AN-4483 6 pages
General Application Considerations for the RCA-HC2000H Hybrid Linear Power Amplifier

This Note briefly describes the RCA HC-2000H hybrid linear amplifier and discusses such operating considerations as dc and ac power dissipation, efficiency as a function of frequency, protection against excessive load variations and reactive loads, and heat-sink requirements.

AN-4782 6 pages
General Application Considerations for the RCA-HC2000H Power Hybrid Operational Amplifier

The RCA-HC2000H is a power hybrid operational amplifier that can deliver 100 watts rms to a 4-ohm load at a maximum peak current of 7 amperes. It operates from a maximum power-supply voltage of 75 volts (single ended) or ± 37.5 volts (split). The low-profile package is light in weight and can be used with either printed-circuit-board connections or commercially available 0.110-inch quick-disconnect push-on terminals. This Note briefly describes the HC2000H and discusses some general application considerations for this amplifier.

Application Note Abstracts

Thyristors (SCR's and Triacs)

AN-3551 6 pages Circuit Factor Charts for RCA Thyristor Applications

In the design of circuits using thyristors, it is often necessary to determine the specific values of peak, average, and rms current flowing through the device. This Note contains charts that show several current ratios as functions of conduction and firing angles for some SCR and triac circuits. Examples are given of the use of these charts in the design of half-wave, full-wave ac, full-wave dc, and three-phase half-wave circuits using RCA thyristors. Current and voltage waveforms for the various circuits are included, as are curves of per-cent ripple in load current and voltage.

AN-3659 6 pages Application of RCA Silicon Rectifiers to Capacitive Loads

This Note describes a simplified rating system that allows designers to calculate the characteristics of capacitive-load rectifier circuits quickly and accurately. The effect of the addition of a series limiting resistance to such circuits and the importance of the ratio of the limiting resistance to capacitive reactance are described; curves of rectifier current ratios are presented as functions of the effective ratio. Typical design examples are given, and output-ripple considerations are discussed.

AN-3697 8 pages Triac Power-Control Applications

This Note describes triac operating characteristics and provides guidance in the use of triacs in specific applications: incandescent lamp controls, light-activated controls, motor controls, heat controls, and a proportional integral-cycle control.

AN-3778 6 pages Light Dimmers Using Triacs

A simple, inexpensive light-dimmer circuit that contains a diac, triac, and RC charge-control network is described. The use of the diac to trigger the triac in light-dimming circuits is explained. The basic light-control circuit is introduced and its operation described. In addition, the components added to improve circuit performance are discussed. Three complete circuits and parts lists are shown for 120-volt, 60-Hz operation and 240-volt, 50/60-Hz operation. Mechanical details involved in building the circuits are discussed, and a trouble-shooting chart is included.

AN-3822 6 pages Thermal Considerations in Mounting of RCA Thyristors

Three simple rules to aid the designer in determining heat-sink specifications for a given application are provided. Power dissipation and heat-sink area, the mounting of thyristors on heat-sinks, typical heat-sink configurations, and chassis-mounted heat-sinks are discussed.

AN-3886 6 pages AC Voltage Regulators Using Thyristors

This Note describes a basic ac-voltage regulating technique using thyristors that prevents ac rms or dc voltage from fluctuating more than ± 3 percent in spite of wide variations in input line voltage. Load voltage can also be held within ± 3 percent of a desired value despite variations in load impedance through the use of a voltage-feedback technique. The voltage regulator described can be used in photocopying machines, light dimmers, dc power supplies, and motor controllers (to maintain fixed speed under fixed load conditions).

AN-4124 8 pages Handling and Mounting of RCA Molded-Plastic Transistors and Thyristors

Detailed guidelines for handling and mounting plastic-packaged RCA power transistors and thyristors are given. Types of packages and suggested mounting hardware to accommodate various mounting arrangements are described. Recommendations are made for handling packages during the forming of leads. Various mounting arrangements, thermal considerations, and cleaning methods are described. This information is intended to supplement the data on electrical characteristics, safe operating area, and performance capabilities in the technical bulletin for each type of plastic-packaged transistor or thyristor.

AN-4242 16 pages A Review of Thyristor Characteristics and Applications

This Note describes the operation, ratings, characteristics and typical applications of thyristors. The basic operation of a thyristor is explained by use of a two-transistor analogy. The significance of voltage and temperature ratings is pointed out. Thyristor gate characteristics, switching behavior, and triggering techniques are described. Use of thyristors in typical power-control applications is discussed.

AN-4537 8 pages Thyristor Control of Incandescent Traffic-Signal Lamps

This Note discusses the use of thyristors in the control of traffic signals. The thyristor most applicable to this application is the triac, which can carry the electrical power required for incandescent traffic-light bulbs, yet can be gated by the low-power signals from electronic control timers or monitoring computers. In addition, the triac is able to handle the large transient currents that result from cold filament turn-on (inrush) and filament rupture (flashover). Triac operation, stresses on triacs in operation with incandescent lamps, and a number of triac circuits for control of incandescent lamps in traffic signal applications are discussed.

AN-4745 6 pages Analysis and Design of Snubber Networks for dv/dt Suppression in Thyristor Circuits

When a triac is used to control an inductive load, voltages with high rates of change (dv/dt) can be generated that can cause a non-gated

turn-on of the triac. The result is a loss of control of power to the load. The simplest method of suppressing this dv/dt stress is to place a series RC network across the main terminals of the triac. The design of this network, commonly called a snubber network, must take into account the peak voltage that can be allowed in the circuit and the maximum dv/dt stress that the device can withstand. This Note analyzes the RC network design and contains graphs that allow a designer to select a snubber to fit a given application.

AN-6054 6 pages Triac Power Controls for Three-Phase Systems

The growing demand for solid-state switching of ac power in heating controls and other industrial applications has resulted in the increasing use of triac circuits in the control of three-phase power. This Note explains a basic approach to the design of triac control circuits for use in the switching of three-phase power. The basic design rules employed in this approach are outlined, an integrated-circuit zero-voltage switch specifically intended for use in triac triggering is briefly described, and the necessity for, and methods of isolation of, the dc logic circuitry in power controls for three-phase systems are pointed out. Recommended configurations are then shown for power-control circuits intended for use with both inductive and resistive balanced three-phase loads, and the specific design requirements for each type of loading condition are discussed.

AN-6096 8 pages Solid-State Approaches to Cooking-Range Control

As a result of decreasing semiconductor costs, advanced system-cost analysis by appliance manufacturers, and increased consumer consciousness, various solid-state range-control designs can be applied in today's appliance market. This Note presents various solid-state design approaches available to the range-control designer.

AN-6141 6 pages Power Switching Using Solid-State Relays

Solid-state relays make use of a semiconductor device for control of ac or dc power. Since, in most ac applications, the semiconductor element chosen for power control is the triac, this Note describes the triac as a power-switching element. Advantages and disadvantages of the active element over the electro-mechanical relay are discussed in general terms. Basic parameters, such as surge in-rush capability, transient-voltage ratings, suppression network, turn-off consideration and the different modes of triac gating are also discussed. AC power control is covered by various circuit designs for ON/OFF control, zero-voltage switching, and line-voltage isolation.

ICAN-6182 28 pages Features and Applications of RCA Integrated-Circuit Zero-Voltage Switches (CA3058, CA3059 and CA3079)

RCA-CA3058, CA3059 and CA3079 zero-voltage switches are monolithic integrated cir-

Application Note Abstracts

cuits designed primarily for use as trigger circuits for thyristors in ac power-control and power-switching applications. These integrated-circuit switches operate from ac input voltages of 24, 120, 208 to 230, or 277 volts at 50, 60, or 400 Hz. Zero-voltage switches trigger the thyristors at zero-voltage points in the supply-voltage cycle. Consequently, transient load-current surges and radio-frequency interference are substantially reduced. Zero-voltage switches also reduce the rate of change of on-state current (di/dt) in the thyristor being triggered and can be adapted for use in a variety of control functions by use of an internal differential comparator to detect the difference between two externally developed voltages.

AN-6286 8 pages
Latching, Gate-Trigger Circuits Using Thyristors for Machine Control Applications

This Note describes a variety of approaches to the development of a solid-state, latching gate drive for the control of ac loads; the solid-state device used is the thyristor. The solid-state circuits described have fewer undesirable characteristics than electro-mechanical devices and are smaller and lighter.

AN-6288 2 pages
Thyristors in Capacitive Discharge (CD) Ignition Systems

This Note describes the requirements of small-engine ignition systems (those deriving electrical energy from a flywheel alternator system), automotive or battery-powered systems, and the ac line-operated igniters. The merits of both capacitive and inductive systems are compared. Both systems are described in

terms of performance and limitations. Practical circuits are shown.

AN-6438 24 pages
Surge Capability of SCR's, Triacs, and Rectifiers

This Note provides the designer with an easy way to derive, from the published sinusoidal capability of any semiconductor, its triangular surge capability for stress durations between 0.5 and 20 milliseconds, and thereby helps him select the most suitable fuse to protect the semiconductor of interest.

AN-6452 16 pages
A New Practical Fuse-Thyristor Coordination Method

This Note describes the possibilities of protecting a semiconductor by fusing—when and how a fuse can be used and how much protection is afforded. Cases for which fuse protection is not possible, or for which only partial protection is feasible are also discussed. Fuse selection methods are described.

AN-6456 12 pages
Characteristics and Applications of RCA Fast-Switching ASCR's

Silicon controlled rectifiers (SCR's) used in applications such as inverters, choppers, and radar pulse modulators at switching frequencies up to 30 kHz require high di/dt and dv/dt capabilities and very short turn-on and turn-off times. This Note explains SCR characteristics required for fast-switching applications, describes a new type of fast-switching SCR, the asymmetrical silicon controlled rectifier (ASCR), and discusses the application of this new type of SCR in induction cooking ranges.

AN-6605 16 pages
Application of RCA Power Devices in Off-Line, High-Frequency Inverter/Converter Circuits

The current trend in power inverter/converter design is to use high-frequency switching techniques and direct operation off the available utility lines (i.e., 110 or 220 volts). The use of higher operating frequencies reduce the magnetic materials required and the size of the filter capacitors. This Note discusses the use of RCA power transistors and SCR's in selected high-frequency inverter/converter applications.

AN-6628 8 pages
Design and Application of High-Power Ultrasonic Converters Using ASCR's

Asymmetrical SCR's with maximum turn-off times of 4 microseconds make possible high-power ultrasonic converters operating at 10 kilowatts at a very competitive price. This Note describes the ASCR structure, explains the basic design principles of an ASCR converter, and discusses the application of this converter to electronic arc-welding equipment and industrial power supplies.

AN-6671 16 pages
Characteristics and Turn-off Circuit Considerations for RCA GTO Silicon Controlled Rectifiers (G4000)

This Note describes the RCA G4000 family of gate turn-off devices designed primarily for automotive and dc switching applications. The description consists of a qualitative discussion of device switching, physical structure, and general applications. Turn-off circuit designs are also discussed. Ratings and characteristics are covered in the appendix.

RCA Sales Offices

Argentina	RCA SAIC, Calle Paroi SSIAN 3930, Buenos Aires	70-4171
Belgium	RCA s.a., Rue De LaFusee 100, 1130 Brussel Bruxelles	02/7208980
Brazil	RCA Electronica Ltda., Av. Ipiranga 1097 CP30443, Sao Paulo	36-6951
Canada	RCA Ltd., 4515 Manhattan Rd. S.E., Calgary, Alberta T2G 4B3 RCA Ltd., 21001 No. Service Rd., Trans-Canada Highway, Ste. Anne de Bellevue, Quebec H9X 3L3	(403)243-6051 (514)457-9000
France	RCA Ltd., 1 Vulcan Street, Rexdale, Ontario M9W 1L3	(416)247-5491
Germany	RCA s.a., 32 rue Fessart, 92100 Boulogne	603 8787
Germany	RCA GmbH, Justus-von-Liebig- Ring 10, 2085 Quickborn b, Hamburg	04106/2001
	RCA GmbH, Linprunstrasse 23, 8000 Munchen 2	089/52 79/28
	RCA GmbH, Zeppelinstrasse 35, D-7302 Ostfildern 4	0711/454001/4
Iran	RCA (Iran) Ltd., 160 Boulevard Elizabeth II, PO Box 12/1359, Tehran	651900/657410
Italy	RCA spa, Divisioni Semi- conduttori, Piazza S. Marco 1, 20121 Milano	637 048/051
Japan	c/oRCA Purchasing Co., N.V. Fugi Bldg., 7-4 Kasumigaseki, 3-Chome, Chiyoda-ku, Tokyo	581-3211
Mexico	RCA S.A. de C.V., Avenida Cuauhtlhuac 2519, Mexico 16, D.F.	(905)527-6020
Spain	RCA S.A., Dr Fleming 43, Madrid 16	250 6955
Sweden	RCA International Ltd., Box 3047, Hagalundsgaten 8, S-17103, Solna 3	08 83 42 25
Taiwan	RCA, 103 Nanking E. Rd., Sect. 2, 2nd Floor, Taipei	571-9171
UK	RCA Ltd., Solid State-Europe, Sunbury-on-Thames, Middlesex TW17 7HW	093 27 85511

U.S.

Alabama	RCA, Holiday Office Center, Suite 41, 3322 So. Memorial Parkway, Huntsville, AL 35801	(205)881-4100
Arizona	RCA, 4227 N. Brown Ave., Suite 4, Scottsdale, AZ 85251	(602)947-7235
California	RCA, 6363 Sunset Blvd., Hollywood, CA 90028 RCA, 4546 El Camino Real, Los Altos, CA 94022 RCA, 8333 Clairemont Mesa Blvd., Suite 105, San Diego, CA 92111 RCA, 17731 Irvine Blvd., Suite 104, Magnolia Plaza, Tustin, CA 92680	(213)468-4156 (415)948-8996 (714)279-0420 (714)832-5302
Colorado	RCA, 2785 N. Speer Blvd., Room 346, Denver, CO 80211	(303)433-8841
Florida	RCA, PO Box 12247, Lake Park, FL 33403 RCA, 1850 Lee Road, Suite 135, Winter Park, FL 32789	(305)626-6350 (305)647-7100
Illinois	RCA, 2700 River Road, Des Plaines, IL 60018	(312)391-4380
Indiana	RCA, Parkwest Office Plaza, 3811 Illinois Rd., Suite 4000, Fort Wayne, IN 46804 RCA, 2511 E. 46th St., Suite Q-1, Atkinson Square, Indianapolis, IN 46205	(219)432-1589 (317)546-4001
Massachusetts	RCA, 109 Highland Avenue, Needham Heights, MA 02194	(617)444-7200
Michigan	RCA, 30400 Telegraph Rd., Suite 440, Birmingham, MI 48010	(313)644-1151
Minnesota	RCA, 6750 Forest Ave. S., Suite 122, Minneapolis, MN 55435	(612)929-0676
Kansas	RCA, 5750 W. 95th St. Suite 111, Overland Park, KS 66207	(913)642-7656
New Jersey	RCA, 1998 Springdale Rd., Cherry Hill, NJ 08003 RCA, 67 Walnut Ave., Clark, NJ 07066	(609)424-3650 (201)574-3550
New York	RCA, 160 Perinton Hill Office Park, Fairport, NY 14450 RCA, One Huntington Quadrangle, Suite 2C14, Huntington Station, LI, NY 11746	(716)223-5240 (516)293-0180
Ohio	RCA, 29525 Chagrin Blvd., Pepper Pike, OH 44122	(216)831-0030
Texas	RCA Center, 8700 Stemmons Freeway, Dallas, TX 75247	(214)638-6434
Virginia	RCA, 1901 N. Moore St., Arlington, VA 22209	(703)558-4161

RCA Manufacturers' Representatives

Arizona	C. T. Carlberg Associates, 4236 North Brown Ave., Scottsdale, AZ 85251	(602)277-2808
California	Bestronics (San Diego Area), 7827 Convoy Court, Suite 407, San Diego, CA 92111	(714)278-2150
Colorado	Waugaman Associates, Inc., 4800 Van Gordon, Wheatridge, CO 80033	(303)423-1020
Delaware	Thomas Associates, Inc., (see New Jersey)	
Florida	G. F. Bohman Associates, 5104 No. Orange Blossom Trail, Suite 115, Rosemont Bldg., Orlando, FL 32804	(305)295-5760
	G. F. Bohman Associates, 15800 SW 84th Court Miami, FL 33157	(305)564-3081
	G. F. Bohman Associates, PO Box 600, Clearwater, FL 33517	(813)442-5606
Idaho	Western Technical Sales, Inc., (No. of Boise, see Washington) R ² Marketing, (E. & S. of Boise, see Utah)	
Illinois	Kebco, 75 Worthington Drive, Maryland Heights, MO 63043	(314)576-4110/4111

Iowa	Lorenz Sales, Inc., Suite 302, Executive Plaza, Cedar Rapids, IA 52402	(319)393-6912
Kansas	Kebeo, PO Box 4805, Overland Park, KS 66204	(913)649-2168
Louisiana	Jackson Arnold Company, (see Texas)	
Michigan	Nicon Associates, 3835 W. Eight Mile Rd., Detroit, MI 48221	(313)341-7688
Minnesota	Comstrand, Inc., 2852 Anthony Lane South, Minneapolis, MN 55114	(612)788-9234
Missouri	Kebeo, 75 Worthington Drive, Maryland MO 63043	(314)576-4110/4111
Montana	R ² Marketing, (see Utah)	
Nebraska	Lorenz Sales, Inc., (see Iowa)	
Nevada	C. T. Carlberg Associates (Clark Co., see Arizona)	
New Jersey	Thomas Associates, Inc., (So. N.J.), 12 South Blackhorse Pike, Bellmawr, NJ 08031	(215)627-6615 (609)933-2600
New Mexico	C. T. Carlberg Associates, PO Box 3177, Station D, Albuquerque, NM 87110	(505)265-1579
New York	L-Mar Associates, Inc., (Upstate NY), 98 Elwell Ave., Binghamton, NY 13901	(607)723-1513

RCA Manufacturers' Representatives

New York	L-Mar Associates, Inc., (Upstate NY) PO Box 7945, Rochester, NY 14606	(716)328-5240
	L-Mar Associates, Inc., 216 Tilden Drive, E. Syracuse, NY 13057	(315)437-7779
North Dakota	Lorenz Sales, Inc., (see Iowa)	
Ohio	Arthur H. Baier Company, 67 Alpha Drive, Cleveland, OH 44143	(216)461-6161
	Arthur H. Baier Company, 4940 Profit Way, Dayton, OH 45414	(513)276-4128
Oregon	Western Technical Sales, Inc., 2035 S.W. 58th Avenue, Portland, OR 97221	(503)297-1711
Pennsylvania	Arthur H. Baier Company, (W. Pa., see Ohio)	
	Thomas Associates, Inc., (E. Pa., see New Jersey)	
South Dakota	Lorenz Sales, Inc., (see Iowa)	
Texas	C. T. Carlberg Associates, (El Paso Area, see New Mexico) Jackson Arnold Company, (Austin, Houston, San Antonio Area), PO Box 42388, Houston, TX 77042	(713)981-5789
Utah	R ² Marketing, 3688 West 2100 South, Salt Lake City, UT 84120	(801)972-5646
Washington	Western Technical Sales, Inc., PO Box 3923, Bellevue, WA 98009	(206)641-3900
West Virginia	Arthur H. Baier Company, (see Ohio)	
Wisconsin	Key Enterprises, 850 Elm Grove Road, Elm Grove, WI 53122	(414)784-3390
Wyoming	Waugaman Associates, Inc. (see Colorado)	

RCA Authorized Distributors

Argentina	Eneka S.A., Tucuman 299, Buenos Aires Radiocom S.R.L., Conesa 1003, Buenos Aires 1426 Technos S.R.L., Medrano 326, Buenos Aires	
Australia	AWA Microelectronics, 348 Victoria Road, Rydalmere NSW 2116 Amtron Tyree, 176 Botany Street, Waterloo, New South Wales 2017	
Austria	Bacher Elektronische Gerate GesmbH, Rotenmuhlgasse 26, A1120, Vienna	022/83 63 960
Belgium	Inelco (Belgium) SA, Avenue Val Duchesse 3, 1160 Brussels	02/660 00 12
Bolivia	Marconi S.R.L., PO Box 143, Yanacochi Street 337, La Paz	
Brazil	Panamericana S.A., Av. Rio Branco 307, Sao Paulo	
Canada	Cesco Electronics, Ltd., 4050 Jean Talon W., Montreal 301, Quebec H4P-1W1	(514)735-5511
	Hamilton Avnet Int'l (Canada) Ltd., 2670 Paulus Street, St. Laurent, Quebec H4S-1G2	(514)735-6393
	Cesco Electronics Ltd., 24 Martin Ross Avenue, Downsview, Ontario M3J-2K9	(416)661-0220
	Cesco Electronics Ltd., 1725 Courtwood Crescent, Ottawa, Ontario K1Z-2B4	(613)729-5118
	Electro Sonic Inc., 1100 Gordon Baker Road, Willowdale, Ontario	(416)494-1666
	Hamilton Avnet Int'l (Canada) Ltd. 3688 Nasha Drive, Units G & H, Mississauga, Ontario L4V-1M5	(416)677-7432
	Hamilton Avnet Int'l (Canada) Ltd., 1735 Court wood Crescent, Ottawa, Ontario K1Z-2B4	(613)226-1700
	L. A. Varah Ltd., 4742 14th Street, NE., Calgary, Alberta	(403)276-8818
	L. A. Varah Ltd., 2077 Alberta Street, Vancouver, B.C. V5Y-1C4	(604)873-3211
	L. A. Varah Ltd., 1-1823 King Edward Street, Winnipeg, Manitoba R2R-0N1	(204)633-6190
Chile	Industria de Radio y Television S.A., Casilla 1407, Santiago	
Colombia	Jose E. Marulanda Montoya, Apartado Aereo 36-97, Bogota	
Denmark	Tage Olsen A/S, Teglværks- gade 37, 2100 Copenhagen	(01)29 48 00
Ecuador	Elecom, S.A., PO Box 9611, Guayaquil	
Finland	Telercas Oy, PO Box 2, SF-01511, Vantaa 51	821655
France	Almex s.a., 48 rue de l'Aubepine, 92160 Antony	666 2112
	Radio Equipements-Antares S.A., 9 rue Ernest Cognacq, 92301 Levallois-perret	Paris 758 11 11
	Tekelec-Airtronic S.A., Cite des Bruyeres, rue Carle-Vernet, 92310 Sevres	Paris 027 75 35
Germany	Alfred Neye-Enatechnik GmbH, 2085 Quickborn-Hamburg, Schillerstrasse 14 Gustav Beck KG, Eltersdorfer Strasse 7 (Postfach 150 280), 8500 Nurnberg 15	4106/612-1 0911/3 49 66
	Elkose GmbH, Laiblinger Weg 12 (Postfach 9), 7141 Schwieberdingen	07150/14-1
	RTG E. Springorum KG, Bronnerstrasse 7, 4600 Dortmund 1	0231/54 951
	Sasco GmbH, 8011 Putz- brunn/Munchen, Hermann- Oberth-Strasse 16	(089)465081
	Spoerle Electronic KG, Otto-Hahn-Strasse 13, 6072 Dreieich 2	06103/604-1
Greece	Omma Limited, 21 Voukour- estiou Street, Athens 134	361 8058
Holland	Inelco Nederland b.v., Joan Muyskenweg 22, Amsterdam 1008 AD	(020)93 48 24
	Vekano BV Daalakersweg 2, Postbus 498, 5600 AI Eindhoven 4502	040 81 09 75
Hong Kong	Gibb, Livingston and Co., PO Box 55	
India	Comel, Sandhurst Bridge, 532 Sardar VP Road, Bombay 7 WB	
Indonesia	NVPD Soedarpo Corp., Jalan Veteran Satu 21-22, Jakarta 1/4	
Iran	Berkeh Co., Ltd., 11, Giti Alley, Tehran	828294
Israel	Eastronics Limited, 11 Rozanis St., Tel-Baruch, PO Box 39300, Tel Aviv 61390	03 475151
Italy	Eledra Sud, Via 6 Valmarana 63, 00139 Roma	06-8127324/8127290
	Idac Elettronica SpA, Via Portello 29, 35100 Padova	049-66022
	Lasi Elettronica S.p.a., Viale Lombardia 6, 20092 Cinisello Balsamo, Milan	6173578
	Silverstar Limited, 20 Via dei Gracchi, 20146 Milan	392/4996
Japan	Okura Trading Co., Ltd., 3-6 Ginza Nichome, Tokyo 104	
Korea	Panwest Co., Ltd., CPO Box 3358/ Room 504-B, Daeyungak Building, 25-5, Chungmu-ro, Chung-ku, Seoul	

RCA Authorized Distributors

Malaysia	Edward Eu & Co. (Pte) Ltd., 193, Jalan LMBI Road, Kuala Lumpur 06-23	
Mexico	Deksa, S.A., Avenida Nuevo Leon #159, Mexico 11, D.F. Mexicana de Bulbos, S.A., Michoacan No. 30, Mexico 11, D.F. Provedora Electronica Industrial, S.A., Apartado Postal 27-599, Mexico 11, D.F.	
New Zealand	AWA New Zealand Ltd., 36-44 Adelaide Rd., PO Box 830, Wellington 2	
Norway	EGA A/S, Hjalmar Brantingsvei 6, Oslo 5	22 19 00
Paraguay	Comp. Com. del Paraguay, S.A., Casilla de Correo 344, Asuncion	
Peru	Arven S.A., Av. Jose Pardo 741, B. Miraflores, Lima 18	
Philippines	Philippine Electronic Ind., PO Box 498, Makati, Rizal D-708	
Portugal	Telectra SARL, 103 Rua Rodrigo da Fonseca, Lisbon 1	68 60 72/75
Singapore	Edward Eu and Co., No. 1 Orchard Rd., 9	
South Africa	Allied Electric S.A. (Pty) Ltd., Components Division, Box 6090, Dunswart 1508 Transvaal	52-8232
Spain	Ataio Ingenieros SA, Enrique Laretta 10y12, Madrid 16	215 35 43
	Electrica Comercial Colominas SA, Division de Novoelectric, Villarreal, 40, Barcelona 11	323 16 90
Sri Lanka	C.W. Mackie & Co., Ltd., 36 D.R. Wijewardena Mawatha, Colombo 10	
Sweden	Ferner Electronics AB, Snoermakarvaegen 35, PO Box 125, S-16126, Bromma-Stockholm	08/80 25 40
	Johan Lagercrantz KB, Kanalvagen 5, Upplanda Vasby	0760 86120
Switzerland	Baerlocher AG, PO Box 485, 8021 Zurich	42 99 00
Taiwan	Hwa Sheng Electronic Co., Ltd., 3th Fl., #7, Ren-al Rd., Sec. 2, Taipei, R.O.C.	(02)3219 311-5
Thailand	Anglo-Thai Eng. Ltd., PO Box 18, Bangkok	
Turkey	Teknika TAS, PO Box Karakoy 153, Istanbul	43 61 00
	Teknim Company Ltd., Riza Sah Pehlevi Caddesi 7, Kavaklidere, Ankara	275800
Uruguay	American Products S.A., Av. Italia 4230, Montevideo	
Venezuela	Telereca, C.A., PO Box 3975, Caracas	
Yugoslavia	Avtotehna, PO Box 593, XI, Titova 36, Ljubljana 61000	317 044
UK	Apex Components Ltd., 396 Bath Road, Slough, Berks, SL1 6JD	Burnham 63741
	Crellon Ltd., 380/386 Bath Road, Slough, Berks, SL1 6JE	Burnham 4434
	Distronic Ltd., 50/51 Burnt Mill, Elizabeth Way, Harlow, Essex, CM20 2HU	Harlow(0279)39701
	ITT Electronic Services, Edinburgh Way, Harlow, Essex, CM20 2DE	Harlow 26811
	Mogul Electronics Ltd., 273 High Street, Epping, Essex, CM 16 4DA	Epping 77366
	Semicomps (Northern) Ltd., East Bowmont Street, Kelso, Roxburghshire TD5 7BZ	Kelso 2366
U.S.		
Alabama	Hamilton-Avnet Electronics, 805 Oster Drive N.W., Huntsville, AL 35805	(205)533-1170
Arizona	Hamilton-Avnet Electronics, 2615 South 21st Street, Phoenix, AZ 85034	(602)275-7851
	Kierulff Electronics, Inc., 4134 East Wood Street, Phoenix, AZ 85040	(602)243-4101
Arizona	Liberty Electronics/Arizona, 8155 North 24th Avenue, Phoenix, AZ 85022	(602)249-2232
California	Cramer/Los Angeles, 17201 Daimler Street, Irvine, CA 92705	(714)979-3000
	Cramer/San Francisco, 720 Palmer Avenue, Sunnyvale, CA 94086	(408)739-3011
	Electronic Supply Corp., 2486 Third Street, Riverside, CA 92507	(714)683-7300
	Elmar Electronics, Inc., 2288 Charleston Road, Mt. View, CA 94042	(415)961-3611
	Hamilton-Avnet Electronics, 575 Middlefield Road, Mt. View, CA 94042	(415)961-7000
	Hamilton-Avnet Electronics, 8917 Complex Drive, San Diego, CA 92123	(714)279-2421
	Hamilton Electro Sales, 10912 W. Washington Blvd., Culver City, CA 90230	(213)558-2020
	Kierulff Electronics, Inc., 2585 Commerce Way, Los Angeles, CA 90040	(213)685-5511
	Kierulff Electronics, Inc., 3969 E. Bayshore Road, Palo Alto, CA 94303	(415)968-6292
	Kierulff Electronics, Inc., 8797 Balboa Avenue, San Diego, CA 92123	(714)278-2112
	Liberty Electronics, 124 Maryland Avenue, El Segundo, CA 90245	(213)322-8100
	Liberty/San Diego, 8248 Mercury Court, San Diego, CA 92111	(714)565-9171
	G.S. Marshall Company, 9674 Telstar Avenue, El Monte, CA 91731	(213)686-0141
	RPS Electronics, Inc., 1501 South Hill Street, Los Angeles, CA 90015	(213)748-1271
	Schweber Electronics Corp., 17811 Gillette Ave., Irvine, CA 92714	(714)556-3880
Colorado	Elmar Electronics/Denver, 6777 East 50th Avenue, Commerce City, CO 80022	(303)287-9611
	Hamilton-Avnet Electronics, 5921 North Broadway, Denver, CO 80216	(303)534-1212
	Kierulff Electronics, Inc., 10890 East 47th Avenue, Denver, CO 80239	(303)371-6500
Connecticut	Arrow Electronics, Inc., 295 Treadwell Street, Hamden, CT 06514	(203)248-3801
	Cramer/Connecticut, 35 Dodge Avenue, North Haven, CT 06473	(203)239-5641
	Hamilton-Avnet Electronics, 643 Danbury Road, Georgetown, CT 06829	(203)762-0361
	Schweber Electronics Corp., Finance Drive, Commerce Industrial Park, Danbury, CT 06810	(203)792-3500
Florida	Arrow Electronics, Inc., 1001 NW 62nd St., Suite 402, Ft. Lauderdale, FL 33309	(305)776-7790
	Arrow Electronics, Inc., 115 Palm Bay Road, N. W., Suite 10, Palm Bay, FL 32905	(305)725-1480
	Cramer/Orlando, 345 Graham Avenue, Orlando, FL 32803	(305)894-1511
	Hamilton-Avnet Electronics, 6800 N.W. 20th Avenue, Ft. Lauderdale, FL 33309	(305)971-2900
	Schweber Electronics Corp., 2830 North 28th Terrace, Hollywood, FL 33020	(305)927-0511

RCA Authorized Distributors

Georgia	Arrow Electronics, Inc., 3406 Oak Cliff Rd., Doraville, GA 30340	(404)455-4054
	Cramer/Atlanta, 6456 Warren Drive, Norcross, GA 30071	(404)448-9050
	Hamilton-Avnet Electronics, 6700 185 Access Road, Suite 1E, Norcross, GA 30071	(404)448-0800
Illinois	Cramer/Chicago, 1911 South Busse Road, Mt. Prospect, IL 60056	(312)593-8230
	Hamilton-Avnet Electronics, 3901 North 25th Avenue, Schiller Park, IL 60176	(312)678-6310
	Newark Electronics, 500 North Pulaski Road, Chicago, IL 60624	(312)638-4411
	Schweber Electronics Corp., 1275 Brummel Ave., Elk Grove Village, IL 60007	(312)593-2740
	Semiconductor Specialists, Inc., 195 Spangler Avenue, Elmhurst, IL 60126	(312)279-1000
Indiana	Graham Electronics Supply, Inc., 133 S. Pennsylvania Street, Indianapolis, IN 46204	(317)634-8202
Iowa	Deeco, Inc., 2500 16th Avenue, S.W., Cedar Rapids, IA 52801	(319)365-7551
Kansas	Hamilton-Avnet Electronics, 9219 Quivira Road, Overland Park, KS 66215	(913)888-8900
	Radio Supply Company, 115 Laura, Wichita KS 67211	(316)267-5214
Louisiana	Sterling Electronics, Inc., 4613 Fairfield, Metairie, LA 70002	(504)887-7610
Maryland	Arrow Electronics, Inc., 4801 Benson Avenue, Baltimore, MD 21227	(301)-247-5200
	Cramer/Washington, 16021 Industrial Drive, Gaithersburg, MD 20760	(301)948-0110
	Hamilton-Avnet Electronics, 7255 Standard Drive, Hanover, MD 21076	(301)796-5000
	Pytronic Industries, Inc., 8220 Wellmoor Court, Savage, MD 20863	(301)792-0782
	Schweber Electronics Corp., 9218 Gaither Road, Gaithersburg, MD 20760	(301)840-9500
Massachusetts	Arrow Electronics, Inc., 960 Commerce Way, Woburn, MA 01801	(617)933-8130
	Cramer Electronics, Inc., 85 Wells Avenue, Newton, MA 02159	(617)969-7700
	Hamilton-Avnet Electronics, 100 East Commerce Way, Woburn, MA 01801	(617)933-8020
	A. W. Mayer Co., Inc., 38 Border Street, West Newton, MA 02165	(617)965-1111
	Schweber Electronics Corp., 213 Third Avenue, Waltham, MA 02154	(617)890-8484
	Sterling Electronics, Inc., 411 Waverly Oak Road, Waltham, MA 02154	(617)894-6200
	Wilshire Electronics/New England, One Wilshire Road, Burlington, MA 01803	(617)272-8200
Michigan	Hamilton-Avnet Electronics, 32487 Schoolcraft Road, Livonia, MI 48150	(313)522-4700
	RS Electronics, Inc., 3444 Schoolcraft, Livonia, MI 48150	(313)525-1155
	Schweber Electronics Corp., 33540 Schoolcraft Road, Livonia, MI 48150	(313)525-8100
Minnesota	Arrow Electronics, 9700 Newton South, Bloomington, MN 55431	(612)887-6400
	Cramer/Minnesota, 5424 Industrial Blvd., Edina, MN 55435	(612)835-7811
	Hamilton-Avnet Electronics, 7683 Washington Avenue, S., Edina, MN 55435	(612)941-3801
	Semiconductor Specialists, Inc., 8030 Cedar Avenue South, Minneapolis, MN 55420	(612)854-8841
Missouri	Hamilton-Avnet Electronics, 364 Brookes Drive, Hazelwood, MO 63042	(314)731-1144
	Semiconductor Specialists, Inc., 3805 No. Oak Traffic Way, Kansas City, MO 64116	(816)452-3900
New Hampshire	Arrow Electronics, Inc., 1 Perimeter Drive, Manchester, NH 03103	(603)668-6968
New Jersey	Arrow Electronics, Inc., Pleasant Valley Road, Moorestown, NJ 08057	(609)235-1900
	Arrow Electronics, Inc., 285 Midland Ave. Saddlebrook, NJ 07662	(201)797-5800
	Cramer/New Jersey, 1 Cardinal Drive, Little Falls, NJ 07424	(201)785-4300
	Hamilton-Avnet Electronics, 218 Little Falls Road, Cedar Grove, NJ 07009	(201)239-0800
	Hamilton-Avnet Electronics, 113 Gaither Drive, East Gate Industrial Park, Mount Laurel, NJ 08057	(609)234-2133
	Kierulff Electronics, Inc., 3 Edison Place, Fairfield, NJ 07006	(201)575-6750
	Resco Electronics, Div. of Astrex, Airport & Central Hwys., Airport Industrial Park, Pennsauken, NJ 08110	(609)662-4000
	Schweber/NJ Electronics, 43 Belmont Drive, Somerset, NJ 08873	(201)469-6008
	Wilshire Electronics/NJ, 1111 Paulison Avenue, Clifton, NJ 07015	(201)340-1900
New Mexico	Cramer/New Mexico, 2460 Alamo S.E., Albuquerque, NM 87106	(505)243-4566
	Hamilton-Avnet Electronics, 2524 Baylor S.E., Albuquerque, NM 87106	(505)765-1500
New York	Arrow Electronics, Inc., 900 Broad Hollow Road, Route 110, Farmingdale, LI, NY 11735	(516)694-6800
	Cramer/Long Island, 29 Oser Avenue, Hauppauge, LI, NY 11787	(516)231-5600
	Cramer/Rochester, 3000 South Winton Road, Rochester, NY 14623	(716)275-0300
	Cramer/Syracuse, 6716 Joy Road, Syracuse, NY 13057	(315)437-6671
	Hamilton-Avnet Electronics, 167 Clay Road, Rochester, NY 14623	(716)442-7820
	Hamilton-Avnet Electronics, 6500 Joy Road, East Syracuse, NY 13057	(315)437-2641
	Hamilton-Avnet Electronics, 70 State Street, Westbury, LI, NY 11590	(516)333-5800
	Milgray Electronics, Inc., 191 Hanse Avenue, Freeport, LI, NY 11520	(516)546-6000
	Rochester Radio Supply Co., 140 W. Main Street, Rochester, NY 14614	(716)454-7800

RCA Authorized Distributors

New York	Schweber Electronics Corp., 2 Town Line Circle, Rochester, NY 14623	(716)424-2222	Pennsylvania	Semiconductor Specialists, Inc., 1000 RIDC Plaza, Suite 207, Pittsburgh, PA 15238	(412)781-8120
	Schweber Electronics Corp., Jericho Turnpike, Westbury, LI, NY 11590	(516)334-7474		Texas	Cramer/Texas, 13740 Midway Road, Dallas, TX 75240
North Carolina	Summit Distributors, Inc., 916 Main Street, Buffalo, NY 14202	(716)884-3450	Hamilton-Avnet Electronics, 445 Sigma Road, Dallas, TX 75240	(214)661-8661	
	Arrow Electronics, Inc., 1377-G Southpark Drive, Kernersville, NC 27284	(919)996-2039		Hamilton-Avnet Electronics, 3939 Ann Arbor Street, Houston, TX 77042	(713)780-1771
	Cramer/Winston/Salem 938 Burke Street, Winston Salem, NC 27103	(919)725-8711		Schweber Electronics Corp., 14177 Proton Road, Dallas, TX 75240	(214)661-5010
	Hamilton-Avnet Electronics, 2803 Industrial Drive, Raleigh, NC 27609	(919)829-8030		Schweber Electronics Corp., 7420 Harwin Drive, Houston, TX 77036	(713)784-3600
Ohio	Hammond Electronics of Carolina, Inc., 2923 Pacific Avenue, Greensboro, NC 27406	(919)275-6391	Sterling Electronics, Inc., 2800 Longhorn, Suite 100, Austin, TX 78758	(512)836-1341	
	Arrow Electronics, Inc., 3100 Plainfield Road, Dayton, OH 45432	(513)253-9176		Sterling Electronics, Inc., 4201 Southwest Freeway, Houston, TX 77027	(713)627-9800
Oklahoma	Cramer/Cleveland, 5835 Harper Road, Solon, OH 44139	(216)248-8400	Sterling Electronics, Inc., 2875 Merrell Road, Dallas, TX 75229	(214)357-9131	
	Hamilton-Avnet Electronics, 761 Beta Drive, Suite E, Cleveland, OH 44143	(216)461-1400		Trevino Electronics, Inc., 2826 Walnut Hill Lane, Dallas, TX 75229	(214)358-2418
	Hamilton-Avnet Electronics, 954 Senate Drive, Dayton, OH 45459	(513)433-0610	Utah	Hamilton-Avnet Electronics, 1585 West 2100 South, Salt Lake City, UT 84119	(801)972-2800
	Hughes-Peters, Inc., 481 East 11th Avenue, Columbus, OH 43211	(614)294-5351		Washington	Hamilton-Avnet Electronics, 13407 Northrup Way, Bellevue, WA 98005
	Schweber Electronics Corp., 23880 Commerce Park Road, Beachwood, OH 44122	(216)464-2970	Liberty Electronics/Northwest, 1750 132nd Ave. N.E., Bellevue, WA 98005		(206)453-8300
	Pennsylvania	The Stotts Friedman Co., 2600 East River Road, Dayton, OH 45439	(513)298-5555	Robert E. Priebe Company, 2211 5th Avenue, Seattle, WA 98121	(206)682-8242
Radio, Inc., 1000 S. Main Street, Tulsa, OK 74119		(918)587-9123	Wisconsin	Arrow Electronics, Inc., 434 West Rawson Avenue, Oak Creek, WI 53154	(414)764-6600
	Herbach & Rademan, Inc., 401 East Erie Avenue, Philadelphia, PA 19134	(215)426-1700	Hamilton-Avnet Electronics, 2975 South Moorland Road, New Berlin, WI 53151	(414)784-4510	
			Taylor Electric Company, 1000 W. Donges Bay Road, Mequon, WI 53092	(414)241-4321	

